



US00D835702S

(12) **United States Design Patent** (10) **Patent No.:** **US D835,702 S**  
**Sakai** (45) **Date of Patent:** **\*\* Dec. 11, 2018**

(54) **LENS FOR CAMERA**

(71) Applicant: **FUJIFILM Corporation**, Tokyo (JP)

(72) Inventor: **Hiroyuki Sakai**, Saitama (JP)

(73) Assignee: **FUJIFILM Corporation**, Tokyo (JP)

(\*\*) Term: **15 Years**

(21) Appl. No.: **29/640,309**

(22) Filed: **Mar. 13, 2018**

**Related U.S. Application Data**

(62) Division of application No. 29/577,116, filed on Sep. 9, 2016, now Pat. No. Des. 815,678.

(30) **Foreign Application Priority Data**

Mar. 10, 2016 (JP) ..... 2016-005298  
Mar. 10, 2016 (JP) ..... 2016-005299

(51) **LOC (11) Cl.** ..... **16-05**

(52) **U.S. Cl.**  
USPC ..... **D16/219**

(58) **Field of Classification Search**

USPC ..... D16/200-220, 239, 235, 242, 250, 310,  
D16/136; D14/251, 138 C, 302, 129,  
D14/130, 496; D26/28, 36, 37, 46, 39;  
D29/104; D10/104.1, 50, 65, 74  
CPC ... G02B 7/02; G02B 7/04; G02B 7/14; G03B  
17/00; G03B 17/14; G03B 9/08; H04N  
5/2252; H04N 5/2253; H04N 5/2254;  
H04N 7/00; F16M 13/00

See application file for complete search history.

(56) **References Cited**

**U.S. PATENT DOCUMENTS**

D248,766 S 8/1978 Arai  
D362,007 S 9/1995 Takahashi  
(Continued)

**FOREIGN PATENT DOCUMENTS**

EM 003367309-0001 9/2016  
EM 003367309-0002 9/2016

**OTHER PUBLICATIONS**

Fujifilm Introduces FUJINON-HF-12M Series, announced Mar. 15, 2016 (online) site visited Nov. 18, 2017, Available <http://www.fujifilm.com/news/n160315.html>.

(Continued)

*Primary Examiner* — Barbara Fox

*Assistant Examiner* — Mary C Ramirez

(74) *Attorney, Agent, or Firm* — Birch, Stewart, Kolasch & Birch, LLP

(57) **CLAIM**

The ornamental design for a lens for camera, as shown and described.

**DESCRIPTION**

The file of this patent contains at least one drawing executed in color. Copies of this patent with color drawings will be provided by the United States Patent and Trademark Office upon request and payment of the necessary fee.

FIG. 1 is a front view of a lens for camera showing the new design;

FIG. 2 is a rear view thereof;

FIG. 3 is a top view thereof;

FIG. 4 is a bottom view thereof;

FIG. 5 is a right side view thereof;

FIG. 6 is a left side view thereof;

FIG. 7 is a front, top perspective view thereof; and,

FIG. 8 is a rear, bottom perspective view thereof.

The broken lines shown in the drawings depict portions of the lens for camera that form no part of the claimed design.

**1 Claim, 7 Drawing Sheets**  
**(6 of 7 Drawing Sheet(s) Filed in Color)**

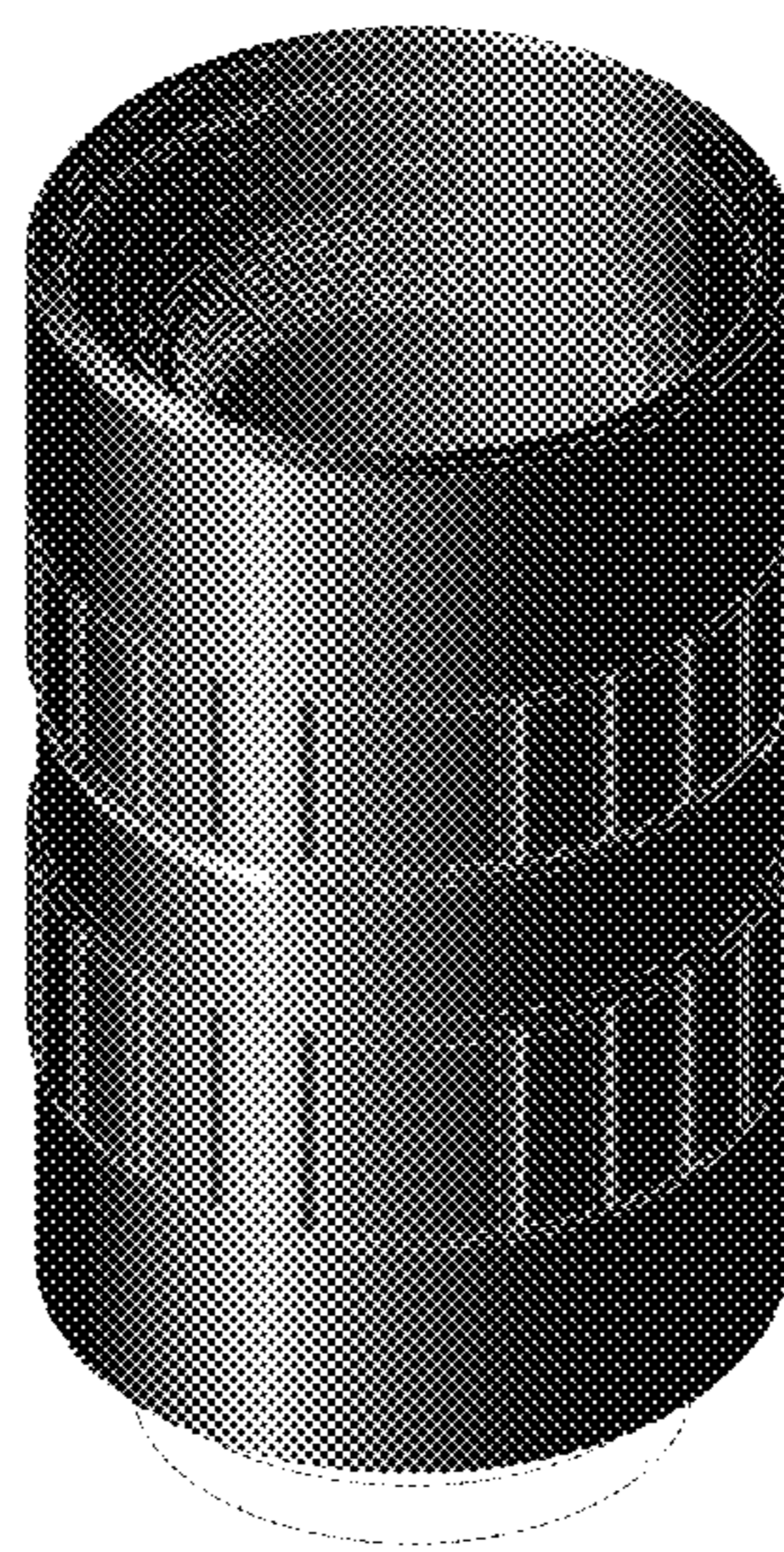
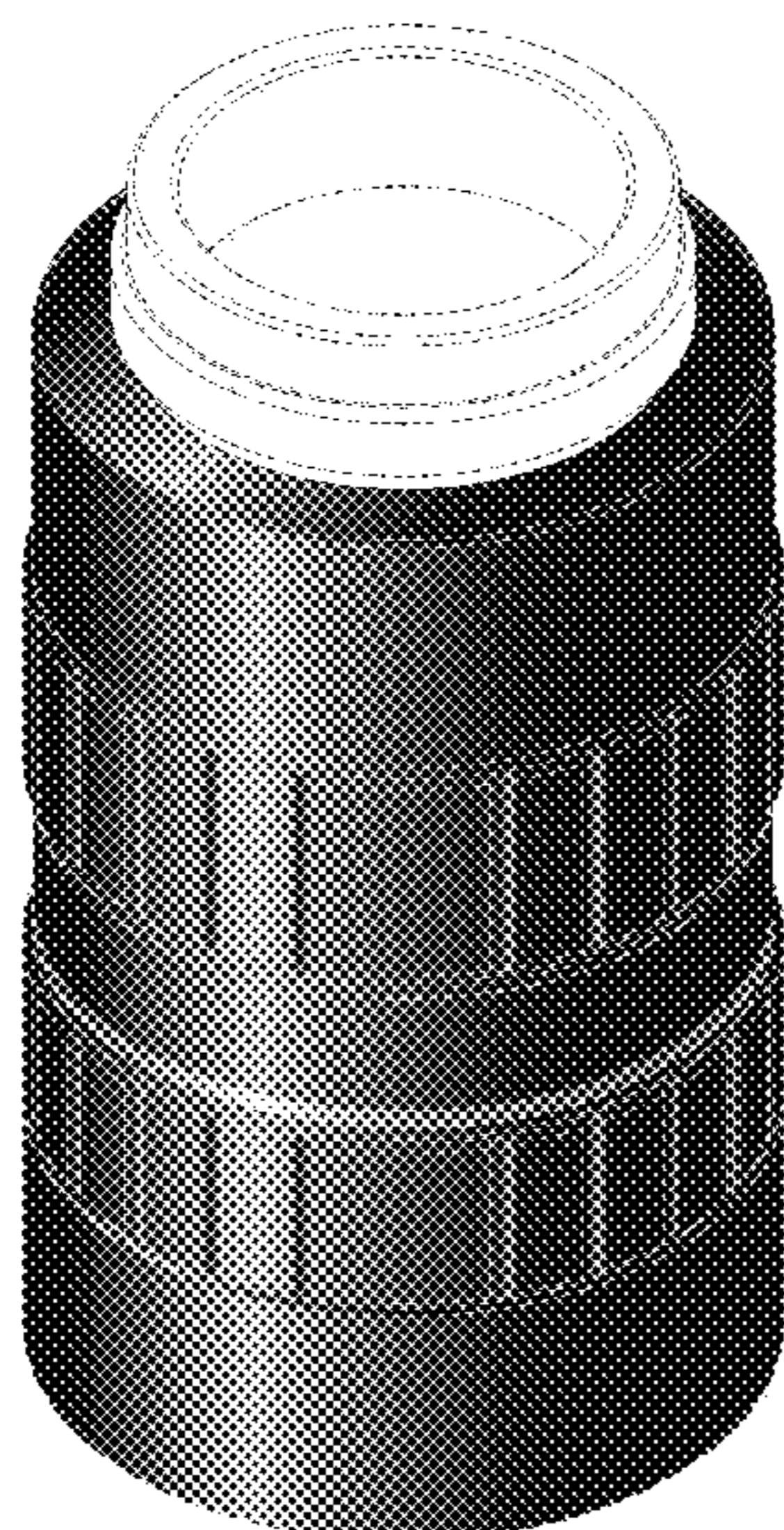

(56)

**References Cited**

U.S. PATENT DOCUMENTS

D412,922	S	8/1999	Sekine	
D425,088	S	5/2000	Watanabe	
D433,044	S	10/2000	Nagaoka	
6,377,408	B1	4/2002	Shinohara	
7,609,953	B2 *	10/2009	Tokiwa .....	G03B 17/14 348/375
9,350,907	B2	5/2016	Matsuura	
D768,224	S	10/2016	Kim	
D781,949	S	3/2017	Lee	
D783,078	S	4/2017	Kim	
9,709,875	B2	7/2017	Awazu	
9,791,660	B2	10/2017	Takeshita	
D815,678	S *	4/2018	Sakai .....	D16/219
2003/0128973	A1	7/2003	Shinohara	
2009/0279192	A1	11/2009	Harada	
2010/0111517	A1	5/2010	Yasuda	
2014/0268365	A1	9/2014	Nishio	
2016/0088223	A1	3/2016	Okazaki	
2017/0184810	A1	6/2017	Shinano	
2017/0235090	A1	8/2017	Takeshita	

OTHER PUBLICATIONS

FUJINON HF-XA series, announced Jun. 24, 2015 (online) site visited Nov. 18, 2017, available <http://www.fujifilm.com/news/n150624.html>.

HF-HA Lenses, announced 2016 (online) site visited Nov. 18, 2017, available [http://www.fujifilmusa.com/products/optical\\_devices/machine-vision/2-3-5/hf125sa-1/#specifications](http://www.fujifilmusa.com/products/optical_devices/machine-vision/2-3-5/hf125sa-1/#specifications).

\* cited by examiner



FIG. 1

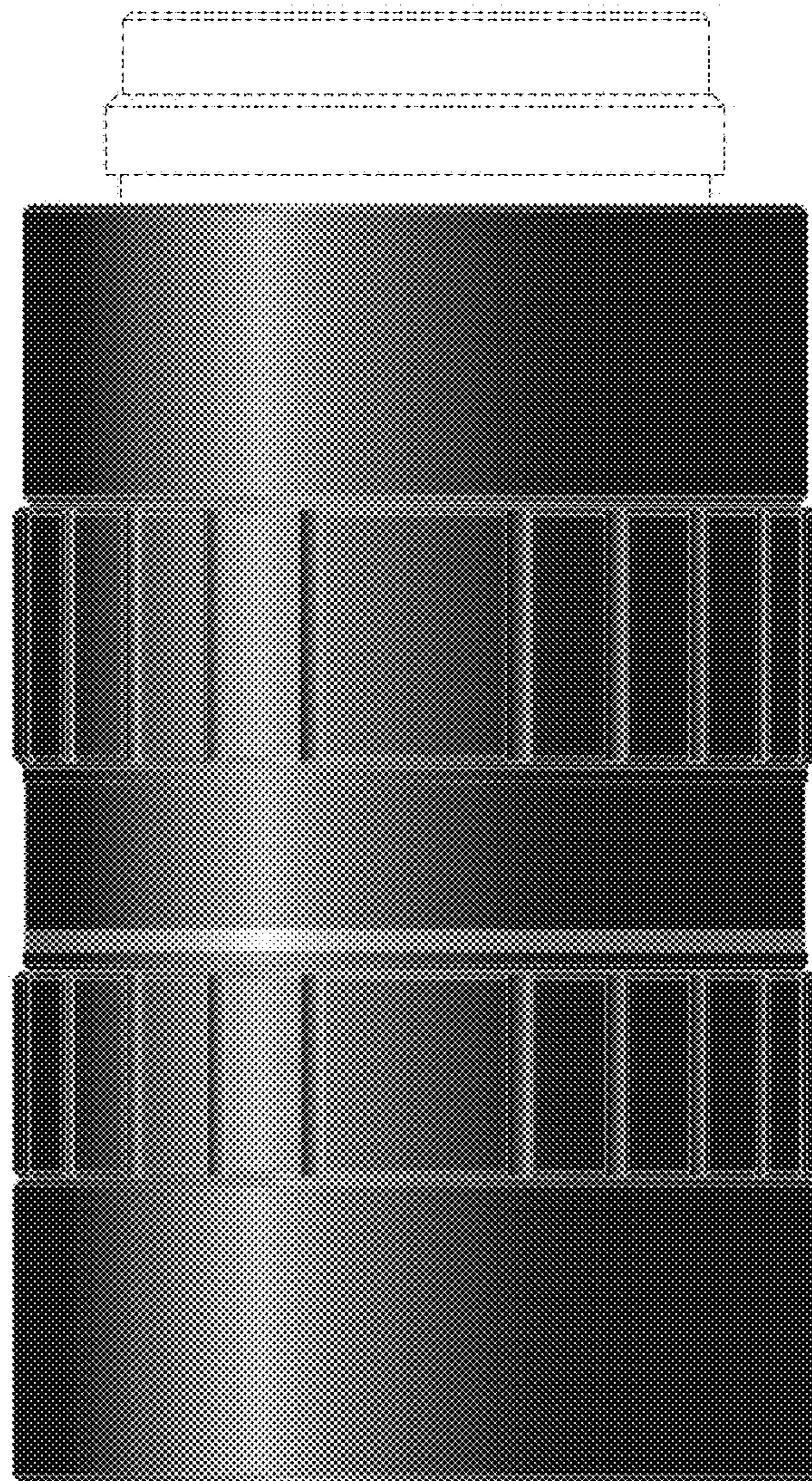
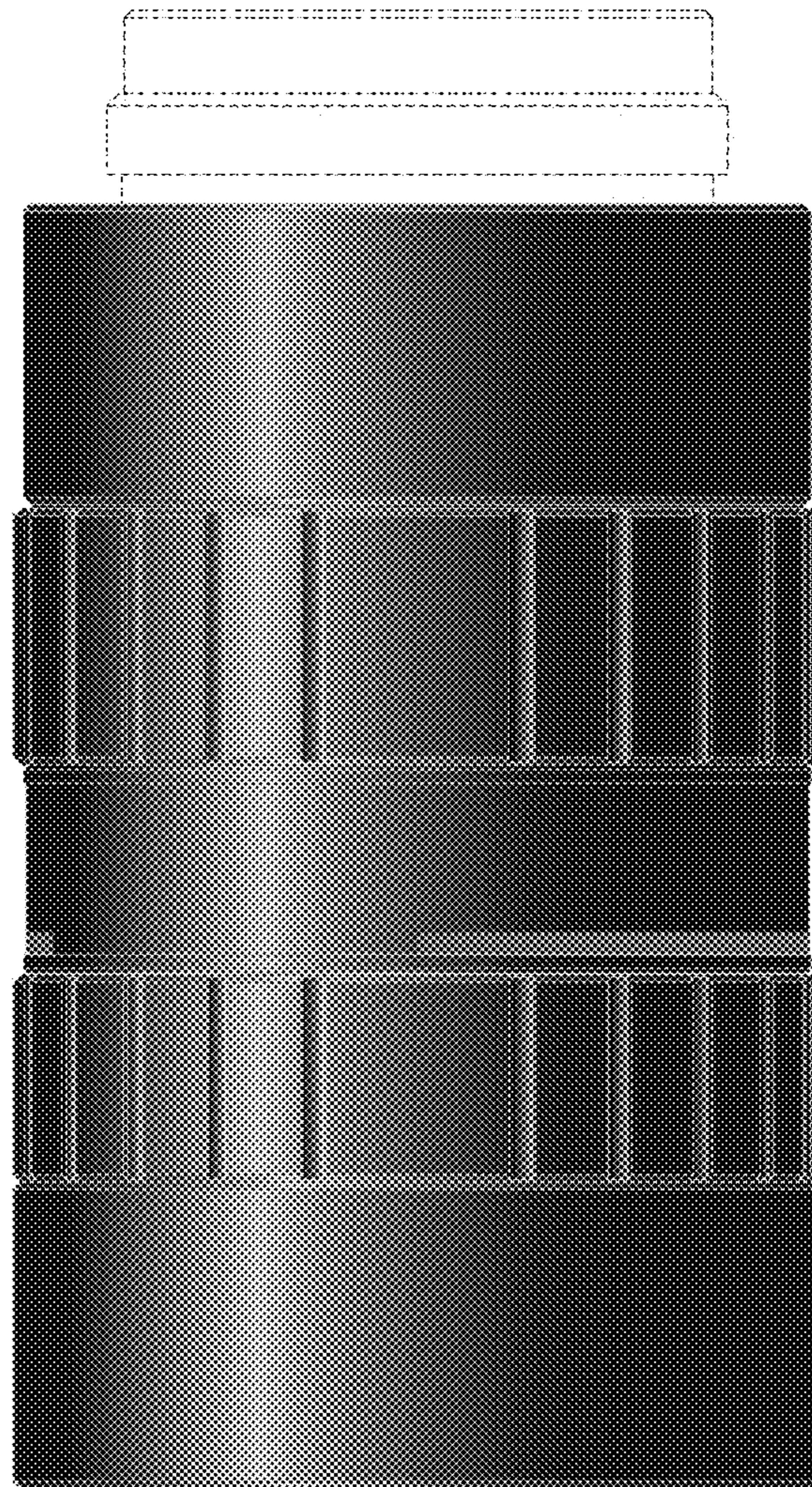

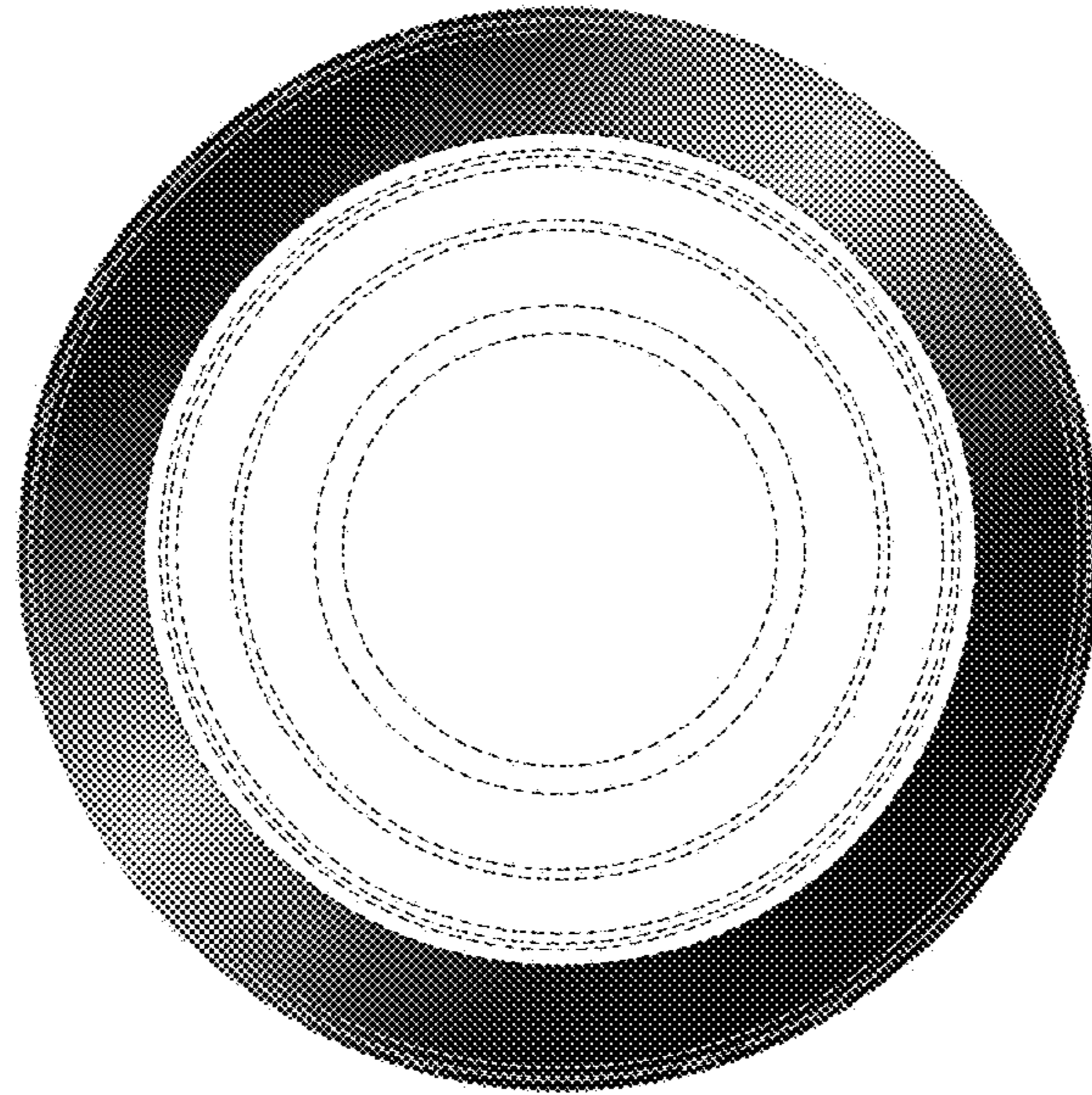

FIG. 2

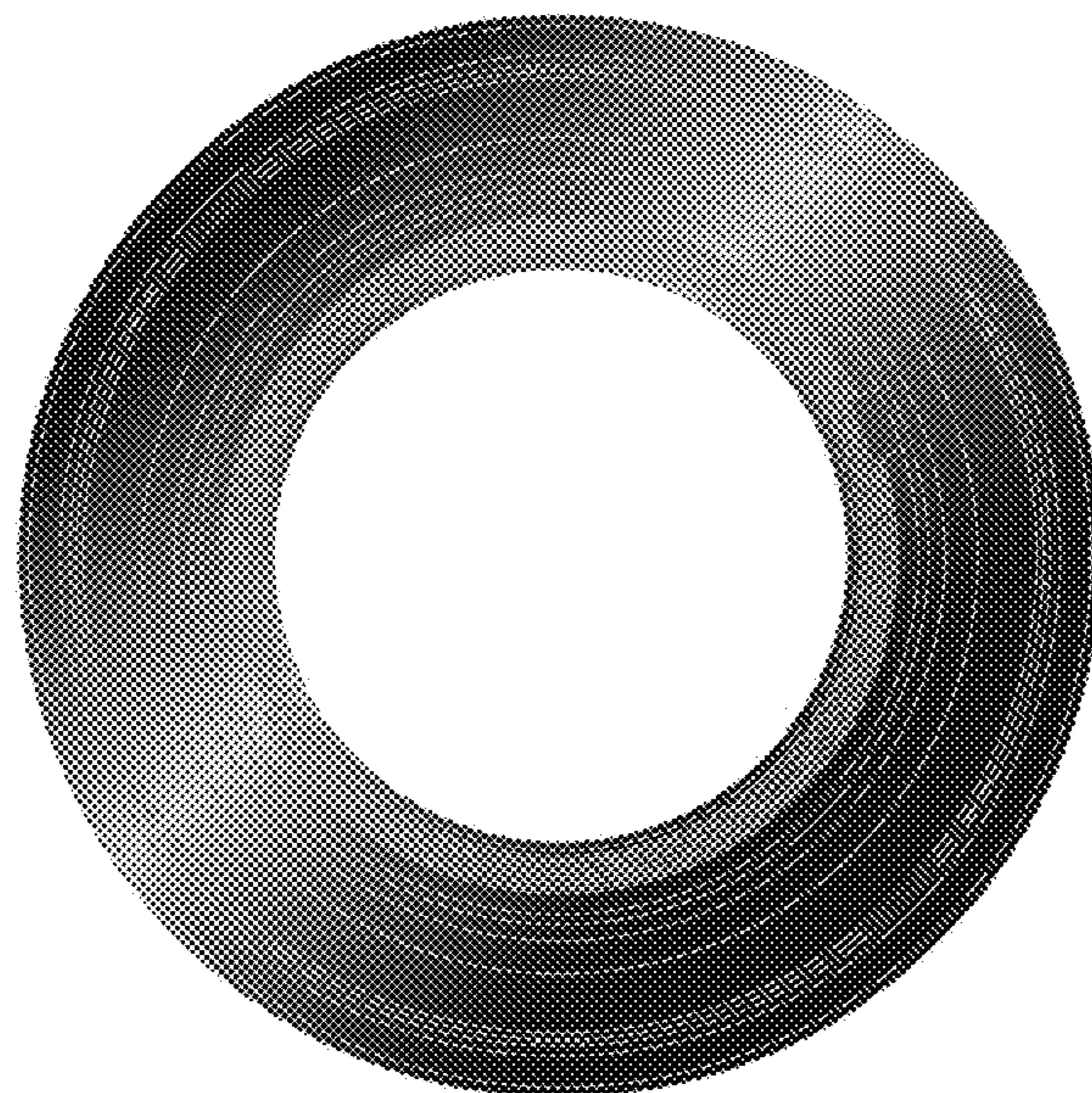



**FIG. 3**

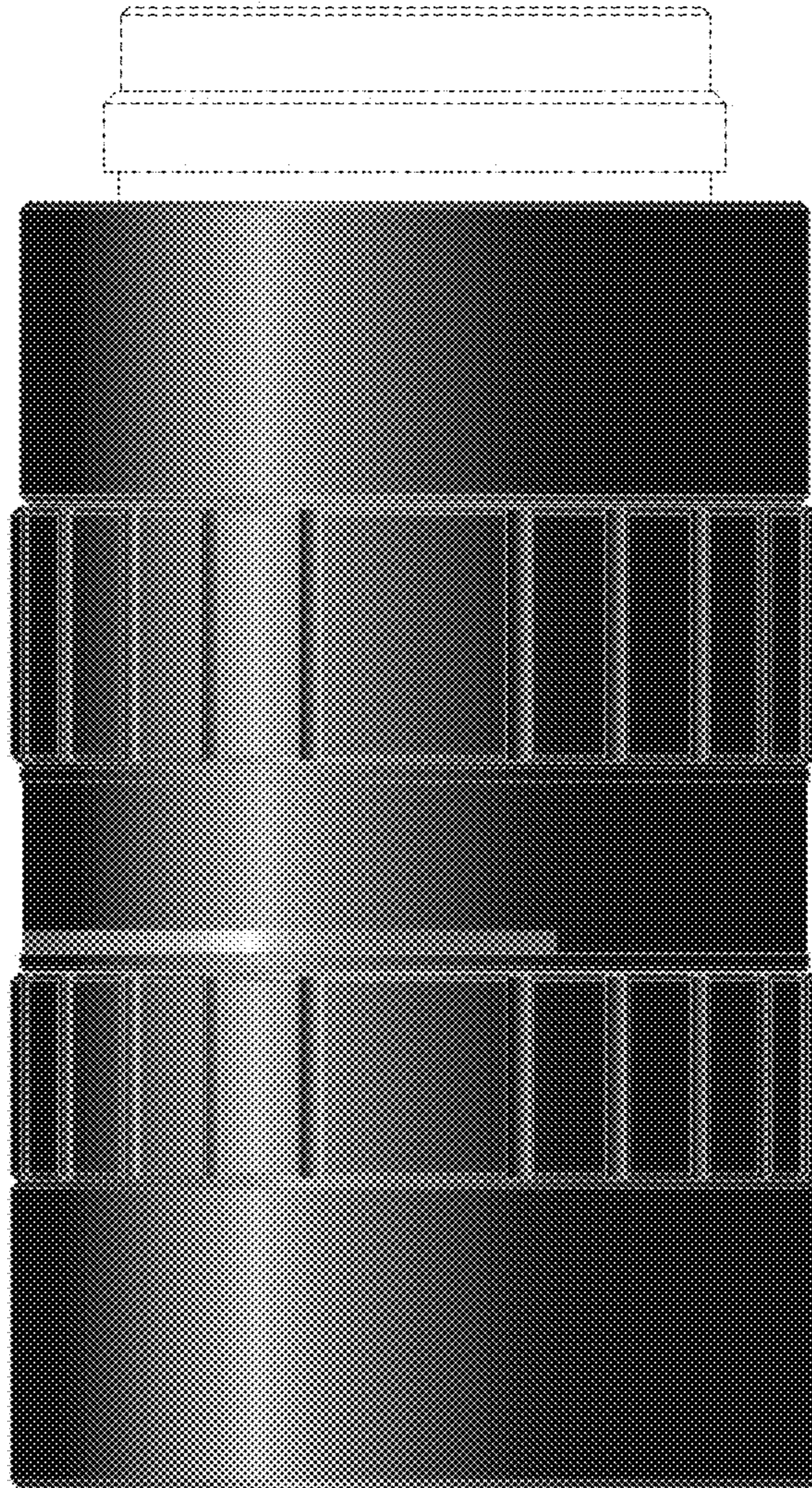

**FIG. 4**



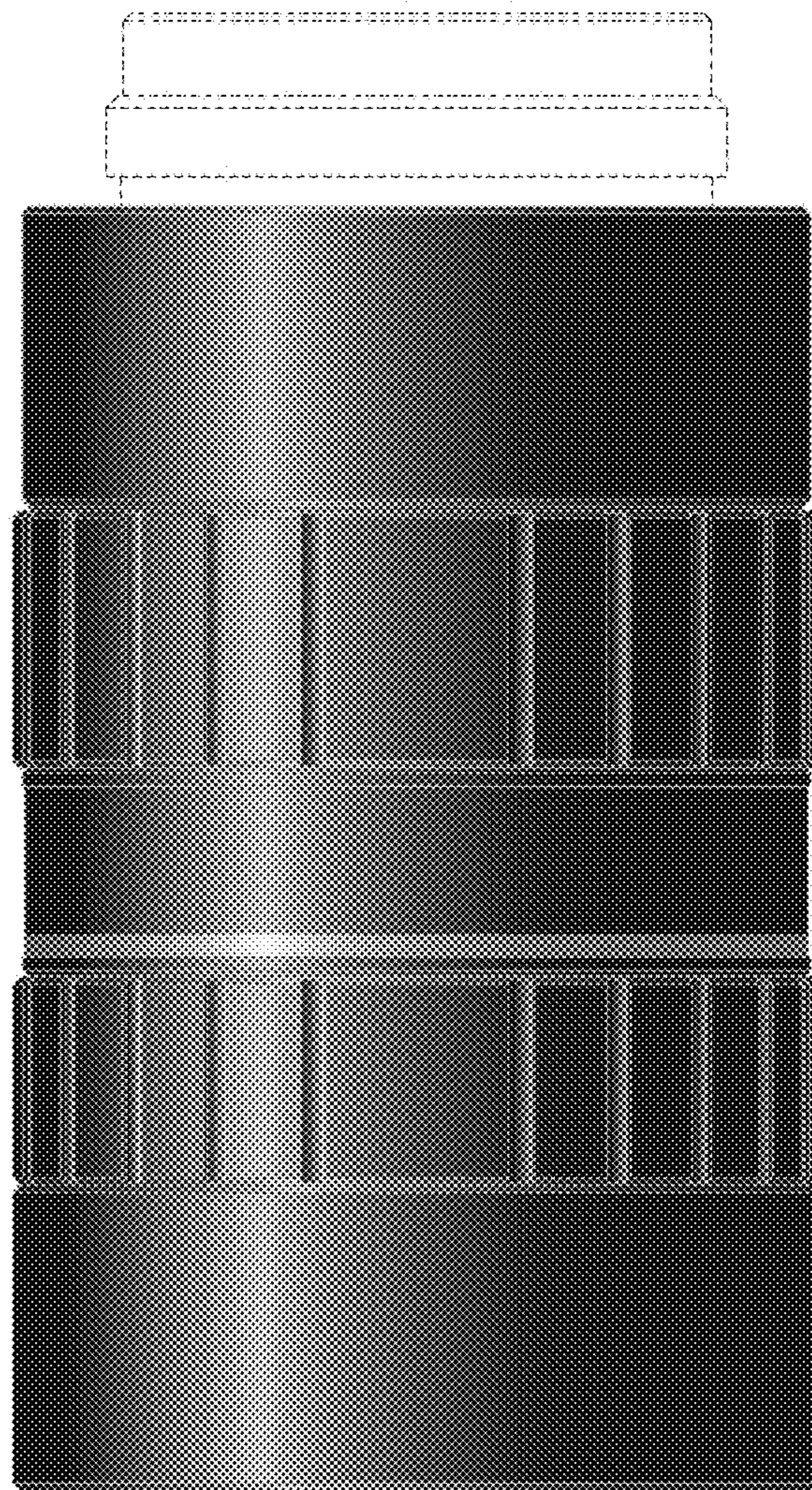

**FIG. 5**



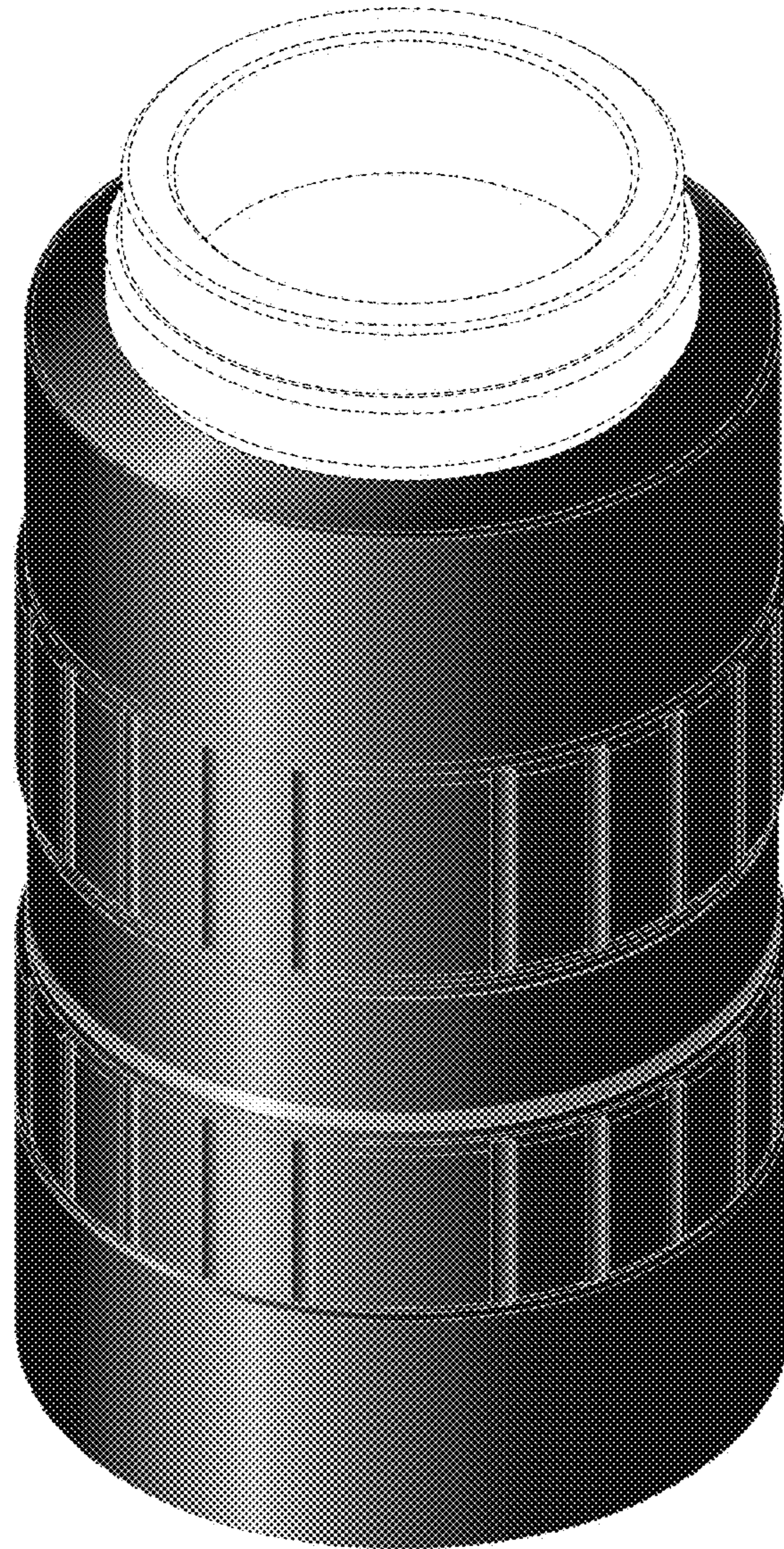

**FIG. 6**





**FIG. 7**





**FIG. 8**

