



US00D835678S

(12) **United States Design Patent** (10) **Patent No.:** **US D835,678 S**
Su (45) **Date of Patent:** **** Dec. 11, 2018**

(54) **PUMPING UNIT**
(71) Applicant: **Zhishen Su**, Heilongjiang (CN)
(72) Inventor: **Zhishen Su**, Heilongjiang (CN)
(73) Assignee: **Daqing Dannuo Petroleum Technology Development Co., Ltd.**, Ranghu Dist., Daqing, Heilongjiang (CN)
(**) Term: **15 Years**
(21) Appl. No.: **29/610,041**
(22) Filed: **Jul. 8, 2017**
(51) **LOC (11) Cl.** **15-02**
(52) **U.S. Cl.**
USPC **D15/7**
(58) **Field of Classification Search**
USPC D15/7-9; D23/231, 232, 225; 417/60, 417/235, 265, 321, 355, 358, 363, 359, 417/410.1, 415-416, 405, 900, 269, 539; 60/408, 412; 52/115-118, 745.18; 415/140-147; 123/495, 509; 137/565.34; 172/122
CPC F02M 37/04; F02M 37/14; F04B 53/92; F04B 1/005; F04D 13/06; F04D 29/22; F04D 29/046; F04D 29/2266; F21B 7/02; E21B 15/09; E21B 15/003; E21B 19/14
See application file for complete search history.

3,788,074 A * 1/1974 Castela E21B 19/09 175/5
3,902,319 A * 9/1975 Olmsted E21B 19/09 175/27
D267,718 S * 1/1983 Gostomski D15/7
D276,434 S * 11/1984 Laney D15/7
D303,263 S * 9/1989 Yeatts D15/7
6,112,834 A * 9/2000 Barrett E21B 19/084 175/162
6,821,071 B2 * 11/2004 Woolslayer E21B 19/14 175/85
7,828,086 B2 * 11/2010 Lesko E21B 7/023 166/77.1
7,931,076 B2 * 4/2011 Ditta E21B 15/00 166/75.11
8,468,753 B2 * 6/2013 Donnally E21B 7/02 173/186
8,646,240 B1 * 2/2014 Patrick E21B 15/00 166/85.1
8,814,487 B2 * 8/2014 Yater E21B 19/14 211/70.4
8,875,447 B2 * 11/2014 Flusche E21B 7/023 52/111
8,959,874 B2 * 2/2015 Wasterval E21B 7/021 52/117

(Continued)

Primary Examiner — Ralf Seifert

(57) **CLAIM**

The ornamental design for pumping unit, as shown and described.

DESCRIPTION

FIG. 1 is a perspective view of pumping unit showing my new design;
FIG. 2 is a front elevational view thereof;
FIG. 3 is a rear elevational view thereof;
FIG. 4 is a left side elevational view thereof;
FIG. 5 is a right side elevational view thereof;
FIG. 6 is a top plan view thereof; and,
FIG. 7 is a bottom plan view thereof.

1 Claim, 7 Drawing Sheets

(56) **References Cited**

U.S. PATENT DOCUMENTS

1,838,956 A * 12/1931 Nottage E21B 19/08 173/151
3,163,005 A * 12/1964 Reed, II E21B 19/09 60/415
3,483,933 A * 12/1969 Dyer E21B 15/00 173/39

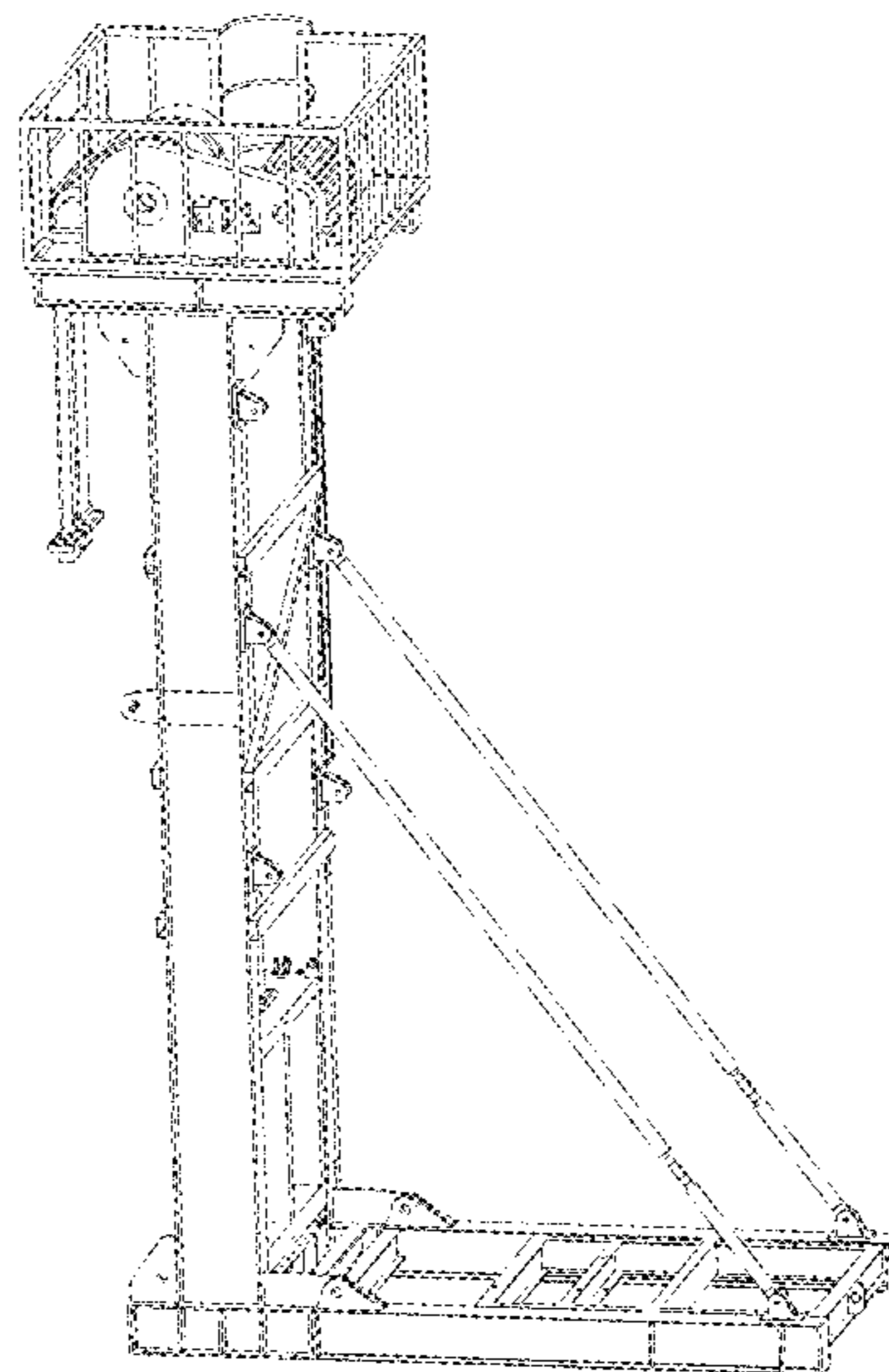

(56)

References Cited

U.S. PATENT DOCUMENTS

9,016,004	B2 *	4/2015	Vogt	E21B 7/023 52/118
9,032,689	B2 *	5/2015	Yustus	E04H 12/344 52/745.18
9,091,125	B2 *	7/2015	Konduc	E21B 15/00
9,212,526	B1 *	12/2015	Barnes	E21B 19/155
9,464,488	B2 *	10/2016	Thiessen	E21B 15/003
9,574,403	B2 *	2/2017	Ferrari	E21B 15/00
9,650,840	B2 *	5/2017	Cheng	E21B 15/00
9,784,051	B2 *	10/2017	Bergan	B63B 39/00
9,879,442	B2 *	1/2018	Magnuson	E21B 19/12
2005/0194189	A1 *	9/2005	Barnes	E21B 7/02 175/122
2009/0200856	A1 *	8/2009	Chegade	E21B 7/02 299/30

* cited by examiner

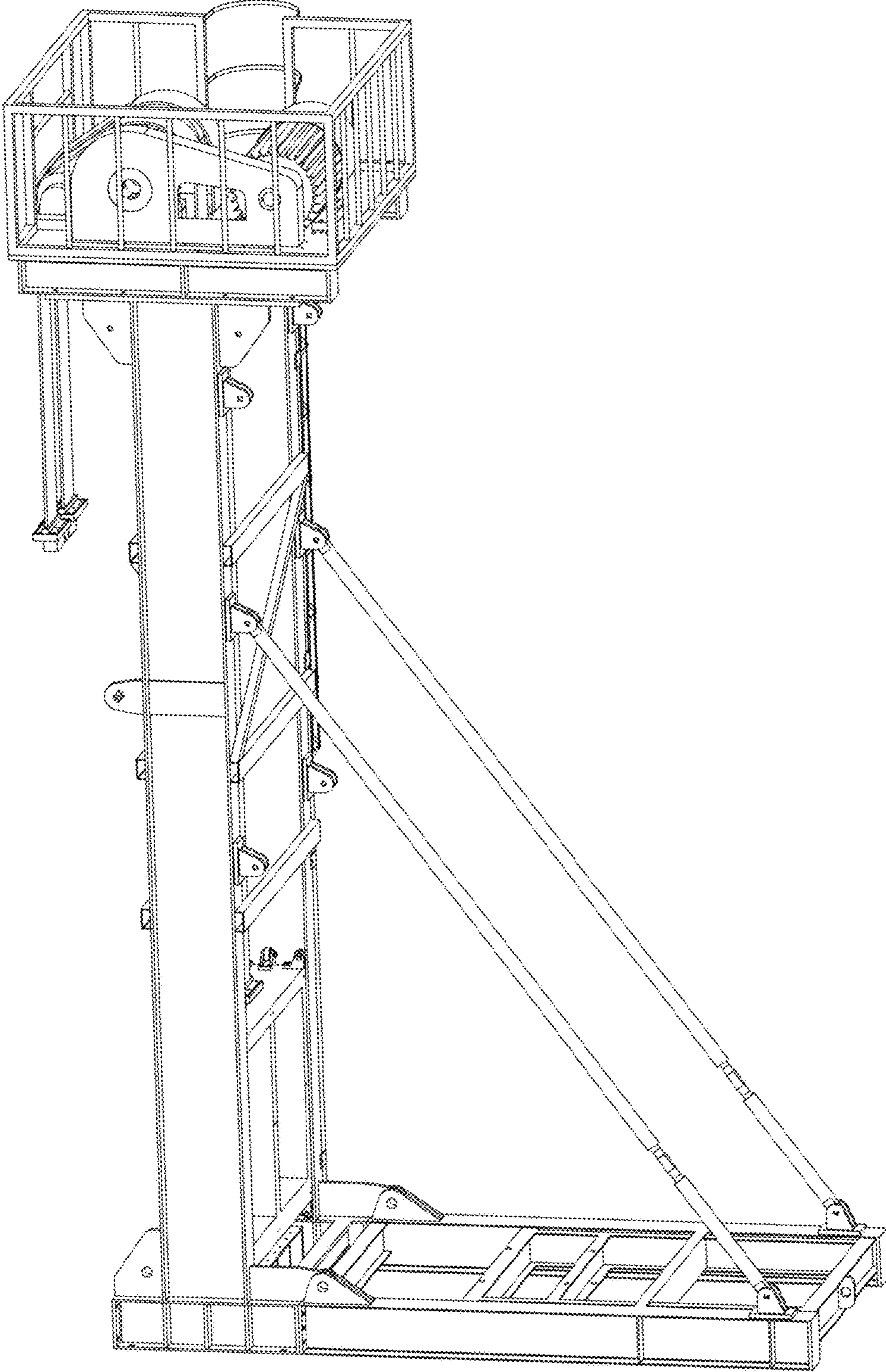

FIG.1

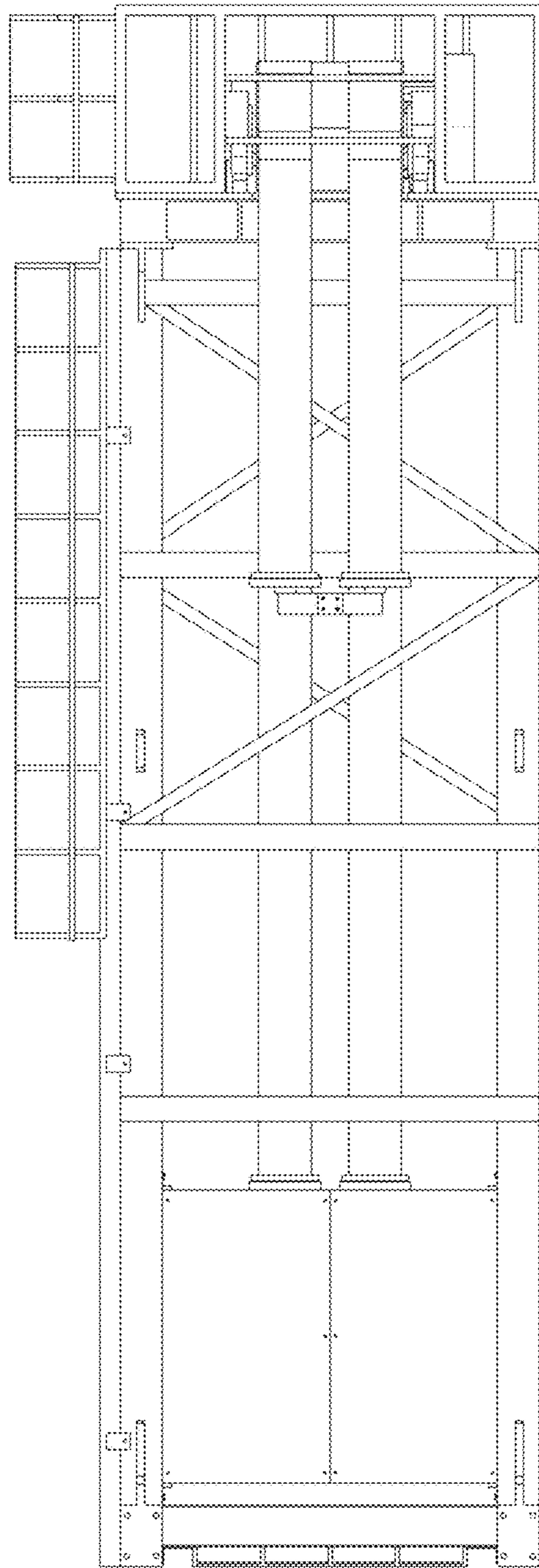

FIG.2

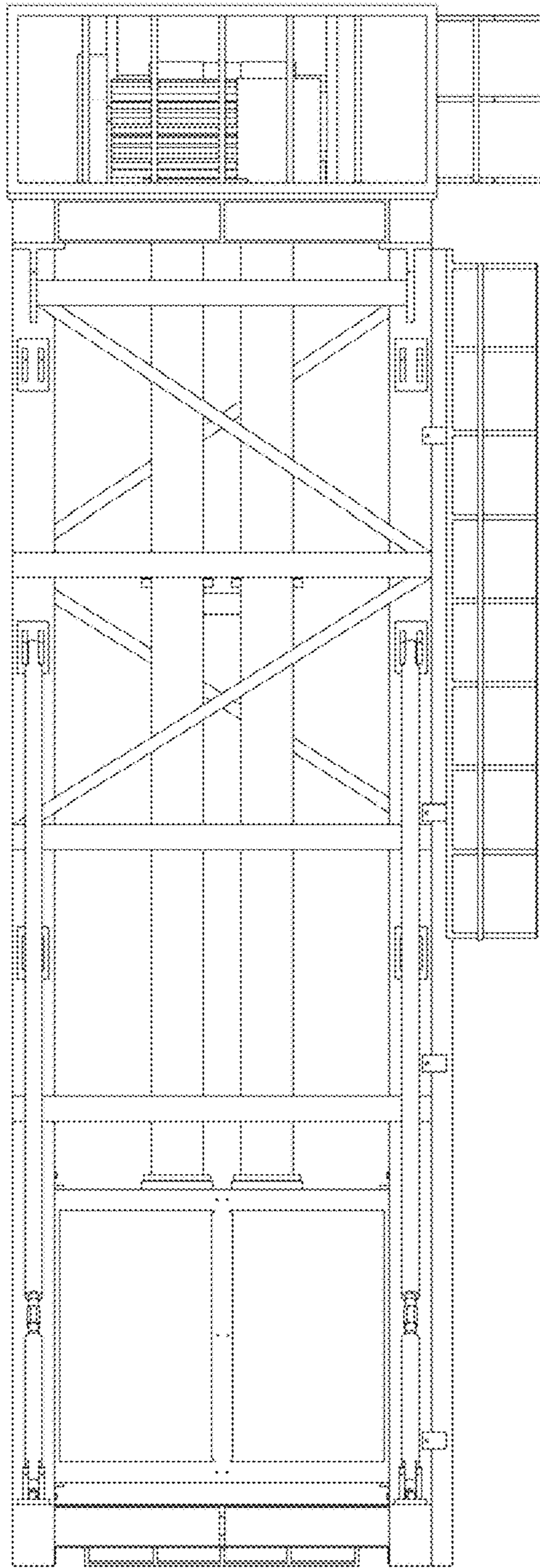

FIG.3

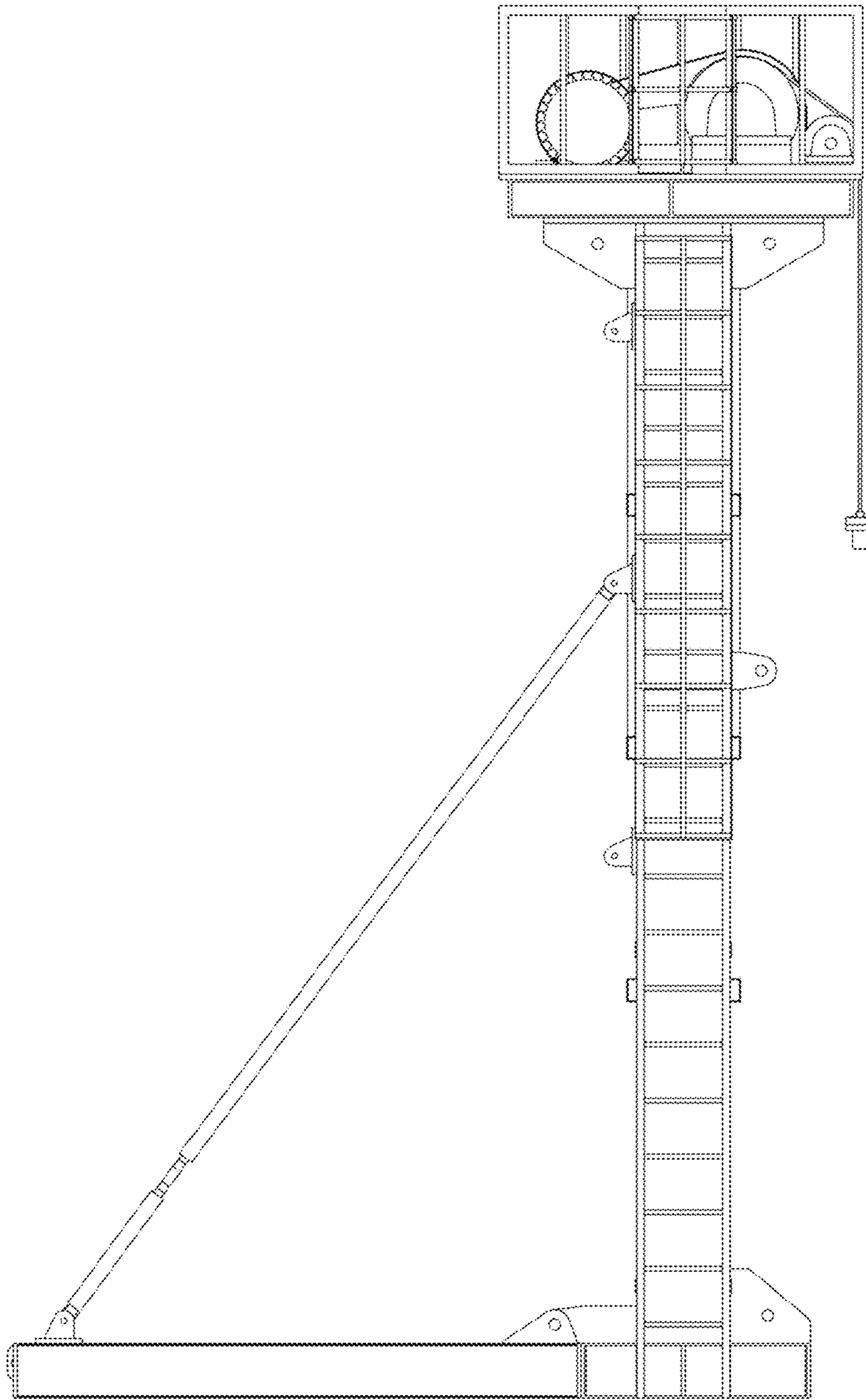

FIG.4

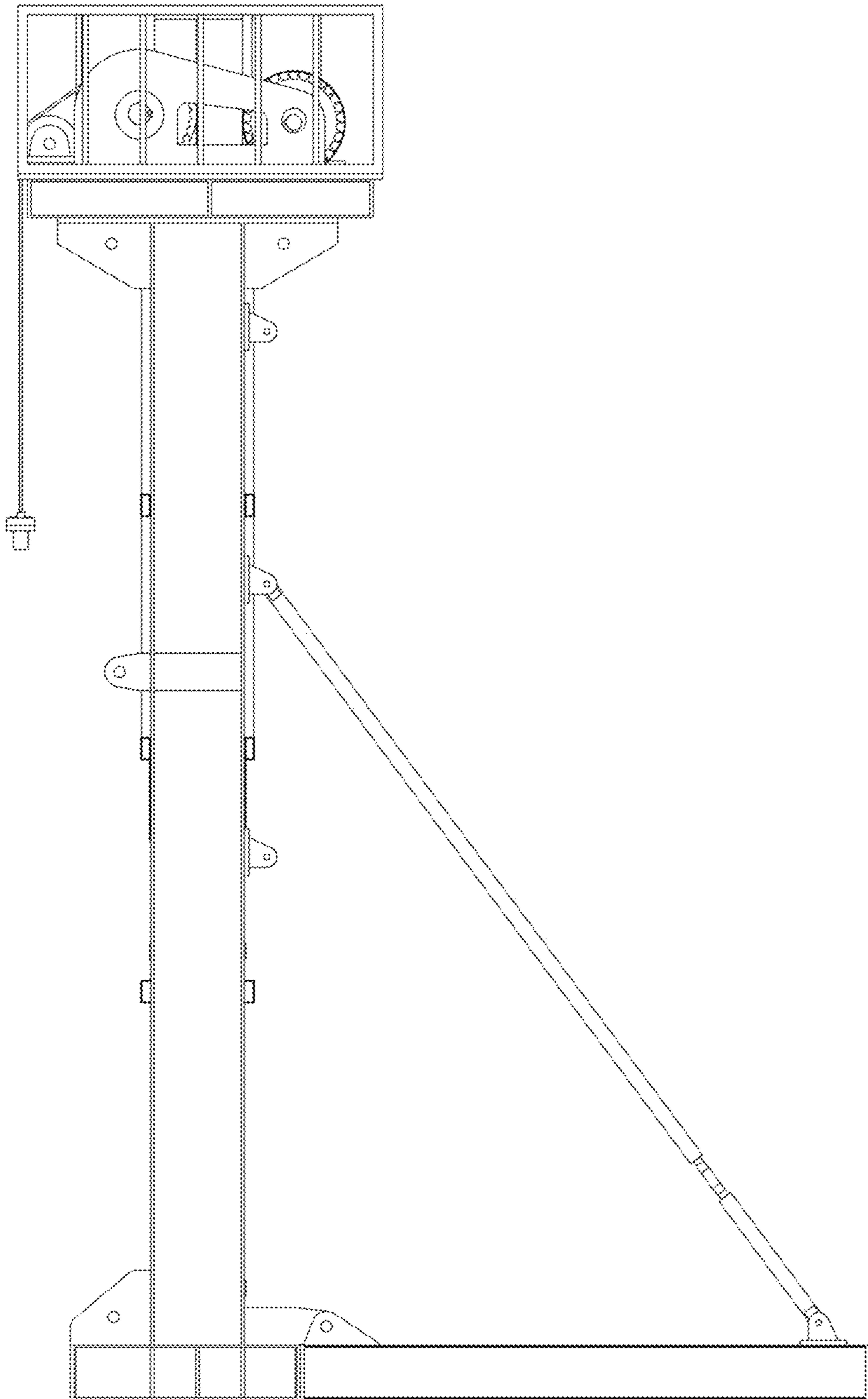

FIG.5

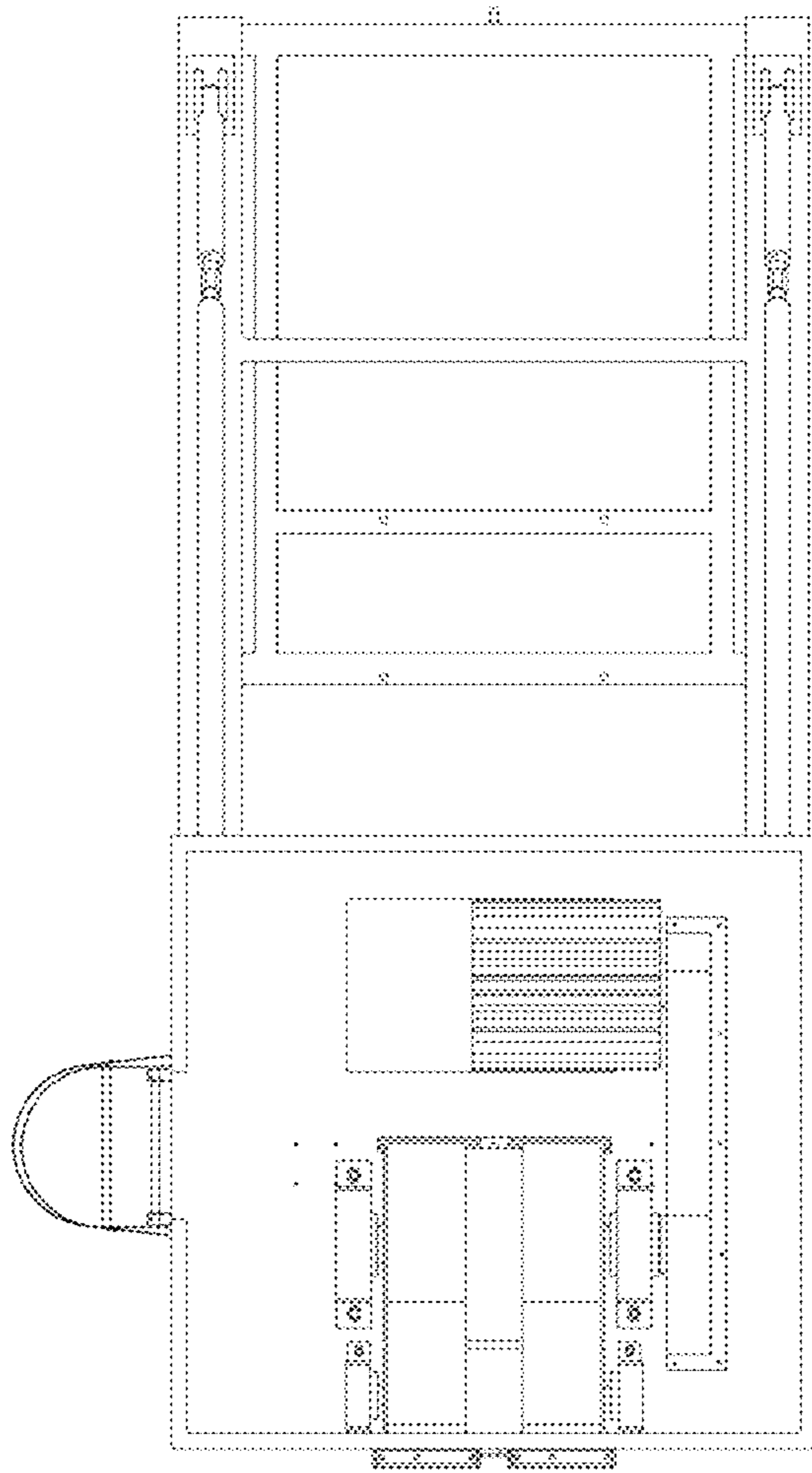

FIG.6

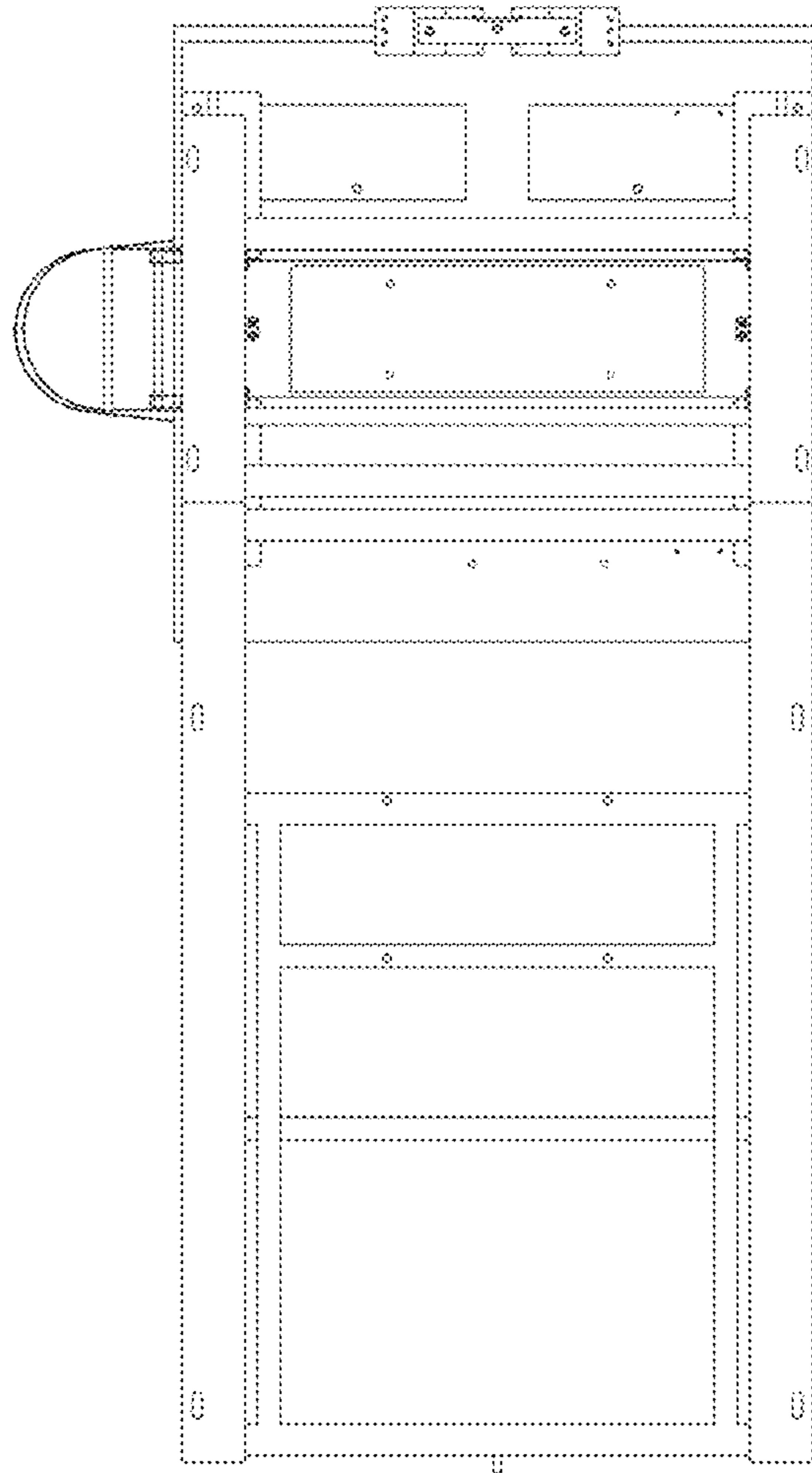

FIG. 7