



US00D835600S

(12) **United States Design Patent** (10) **Patent No.:** **US D835,600 S**
Weiss et al. (45) **Date of Patent:** **** Dec. 11, 2018**

(54) **SOUND MACHINE**

(71) Applicant: **Hatch Baby, Inc.**, Menlo Park, CA (US)

(72) Inventors: **David Weiss**, Palo Alto, CA (US); **Ann C. Weiss**, Palo Alto, CA (US); **Stuart Tyrrell**, Los Altos, CA (US); **Jillian Locks**, San Mateo, CA (US); **Philip Bourgeois**, Woodside, CA (US); **George Turvey**, Brookdale, CA (US); **Martin Schnitzer**, San Francisco, CA (US)

(73) Assignee: **Hatch Baby, Inc.**, Menlo Park, CA (US)

(**) Term: **15 Years**

(21) Appl. No.: **29/588,608**

(22) Filed: **Dec. 21, 2016**

(51) **LOC (11) Cl.** **14-01**

(52) **U.S. Cl.**
USPC **D14/204**

(58) **Field of Classification Search**
USPC D14/188, 204, 209.1, 210–215, 348, 349, D14/352, 498–505; 181/143, 144, 148, 181/153, 157, 198, 199; 369/6–12; 381/300–303, 361–364, 366, 386–388
CPC H04R 1/02; H04R 1/021; H04R 1/025; H04R 1/026; H04R 1/028; H04R 1/403; H04R 1/2803; H04R 1/2834; H04R 5/02; H04R 9/06; H04R 19/013; H04R 2400/00

See application file for complete search history.

(56) **References Cited**

U.S. PATENT DOCUMENTS

D484,491 S	*	12/2003	Solland	D14/216
D484,871 S	*	1/2004	Solland	D14/216
D488,800 S	*	4/2004	Wiener	D14/207
D500,296 S	*	12/2004	Zeitman	D14/144
D538,112 S	*	3/2007	Jeffrey	D7/612
D691,587 S	*	10/2013	Ferber	D14/216
D692,413 S	*	10/2013	Holzer	D14/215
D695,713 S	*	12/2013	Szymanski	D14/216
D711,353 S	*	8/2014	Szymanski	D14/216
D735,163 S	*	7/2015	Valeur	D14/216

* cited by examiner

Primary Examiner — Derrick E Holland

Assistant Examiner — Janice Patyk

(74) *Attorney, Agent, or Firm* — Levin Bagade Ham LLP

(57) **CLAIM**

The ornamental design for a sound machine, as shown and described.

DESCRIPTION

FIG. 1 is a top perspective view of a sound machine; FIG. 2 is another top perspective view of the sound machine; FIG. 3 is a bottom perspective view of the sound machine; FIG. 4 is a front view of the sound machine; FIG. 5 is a rear view of the sound machine; FIG. 6 is a top plan view of the sound machine; and, FIG. 7 is a bottom plan view of the sound machine. The elements shown in broken lines form no part of the claimed design.

1 Claim, 7 Drawing Sheets

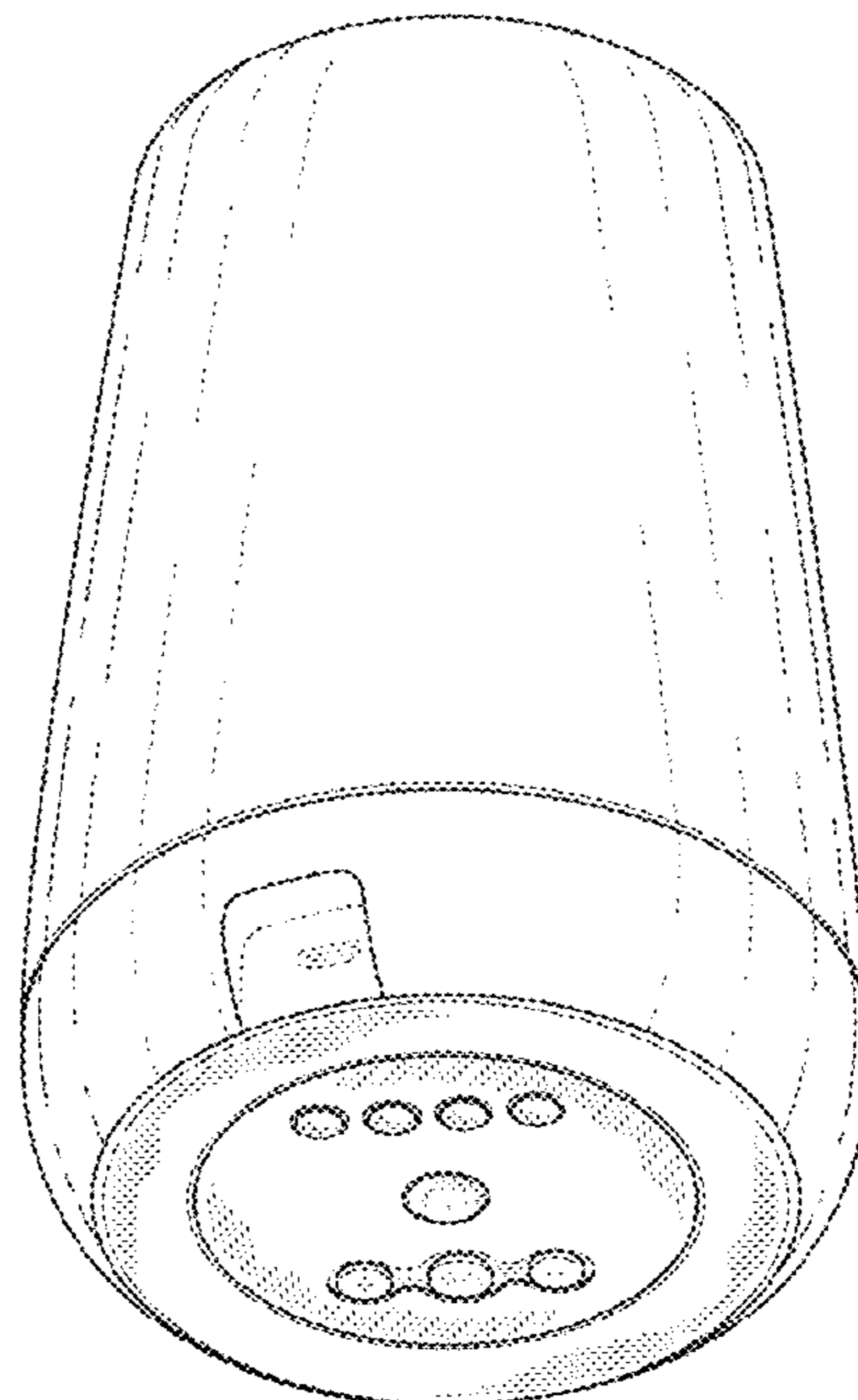
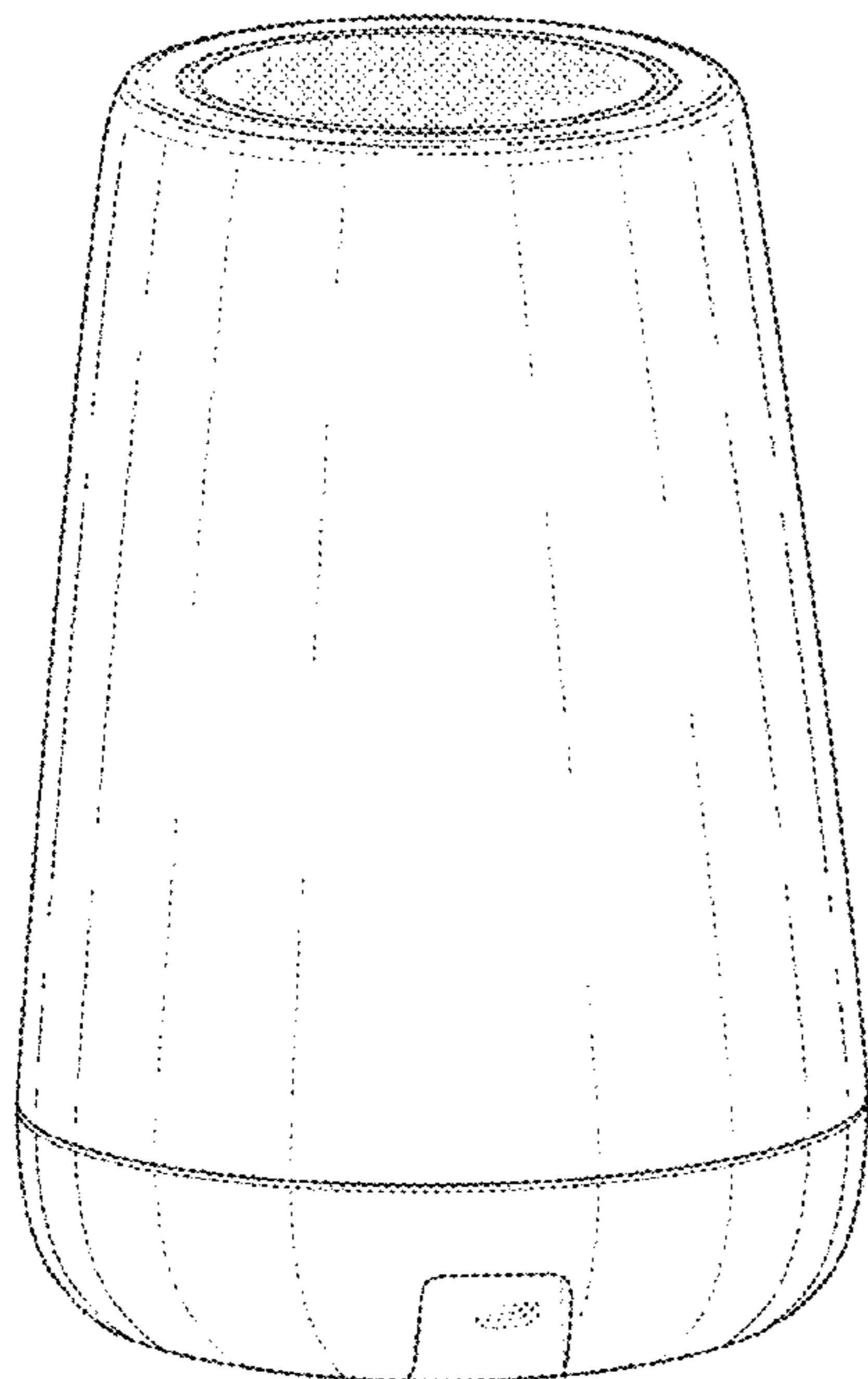

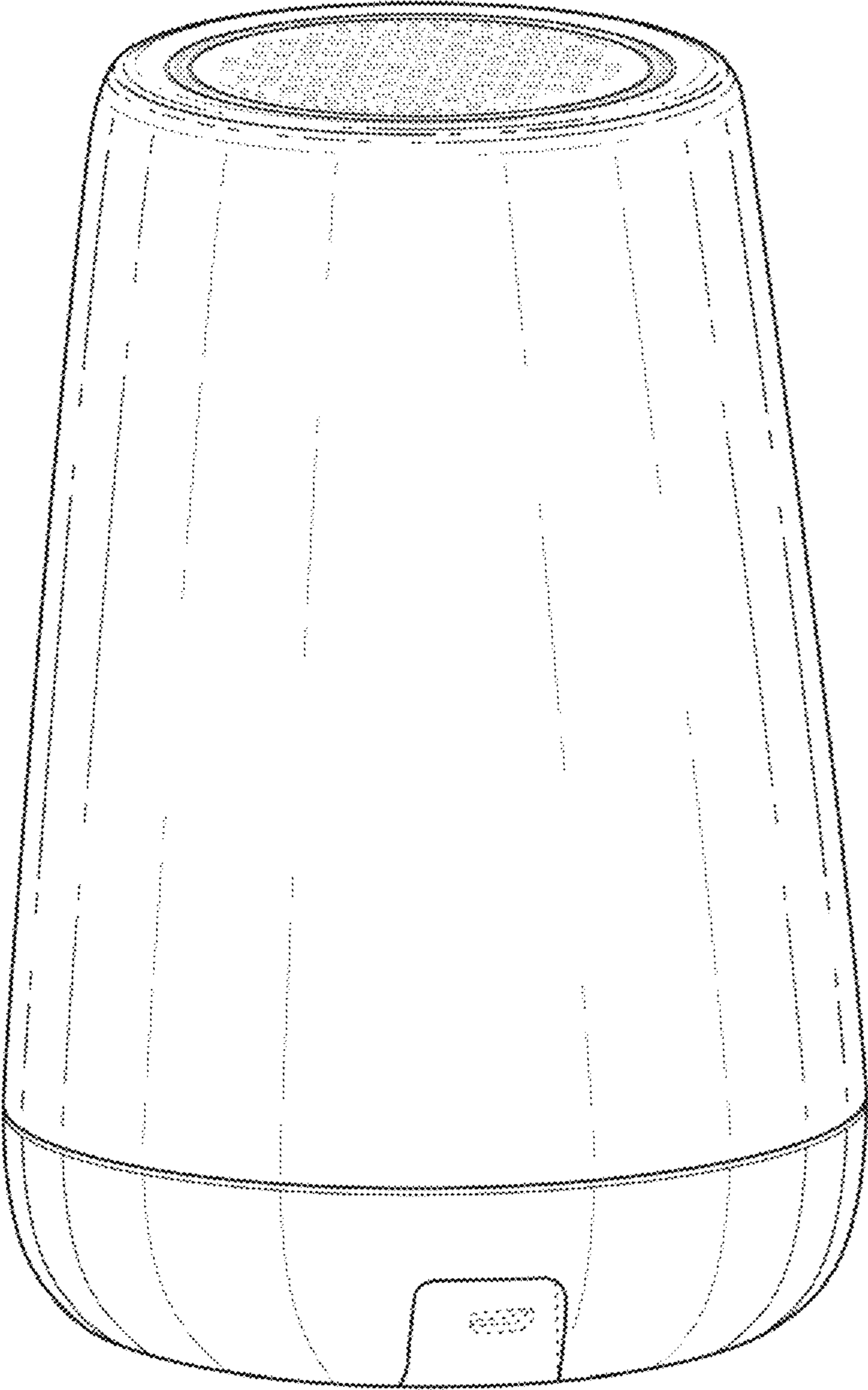

FIG. 1

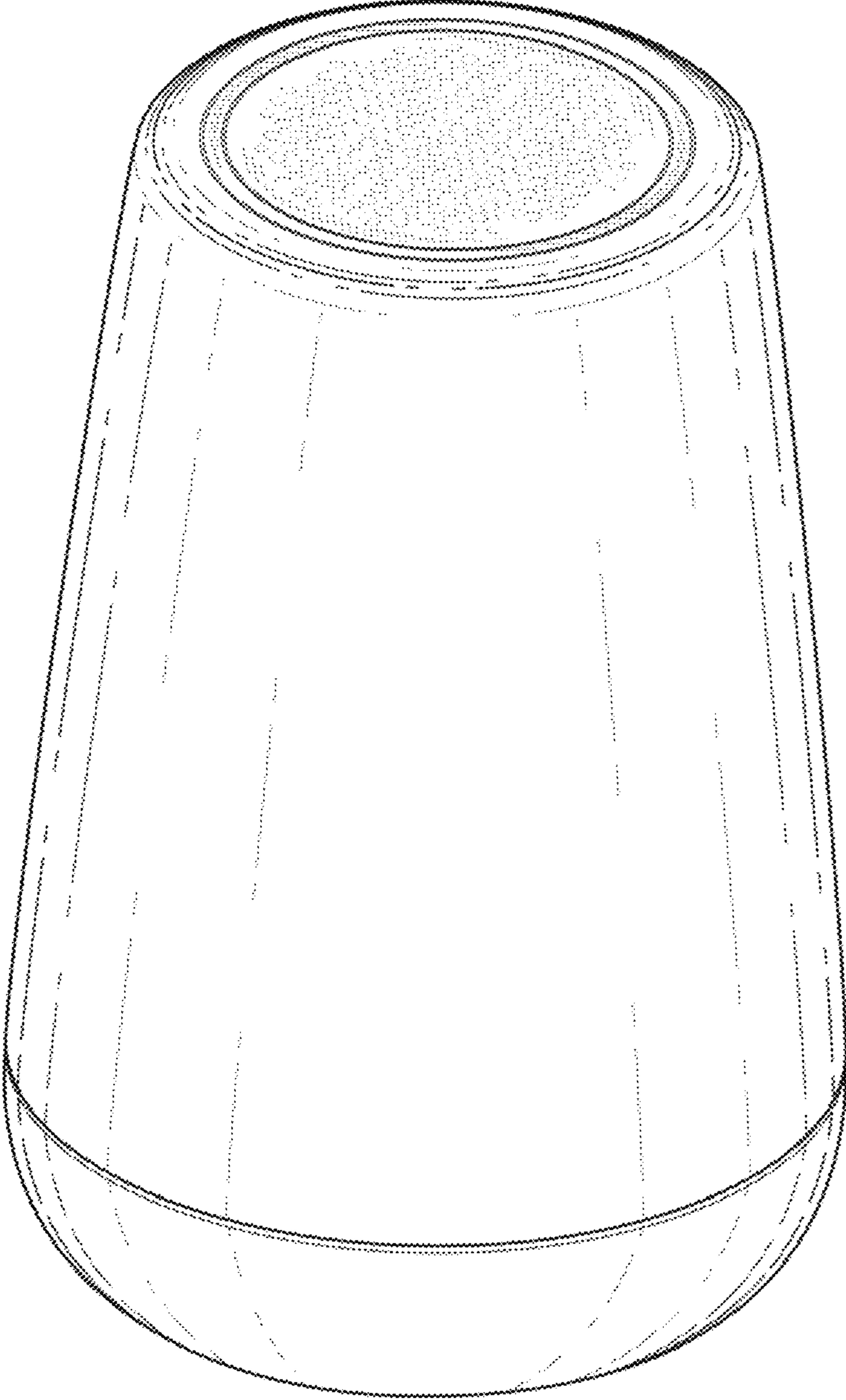

FIG. 2

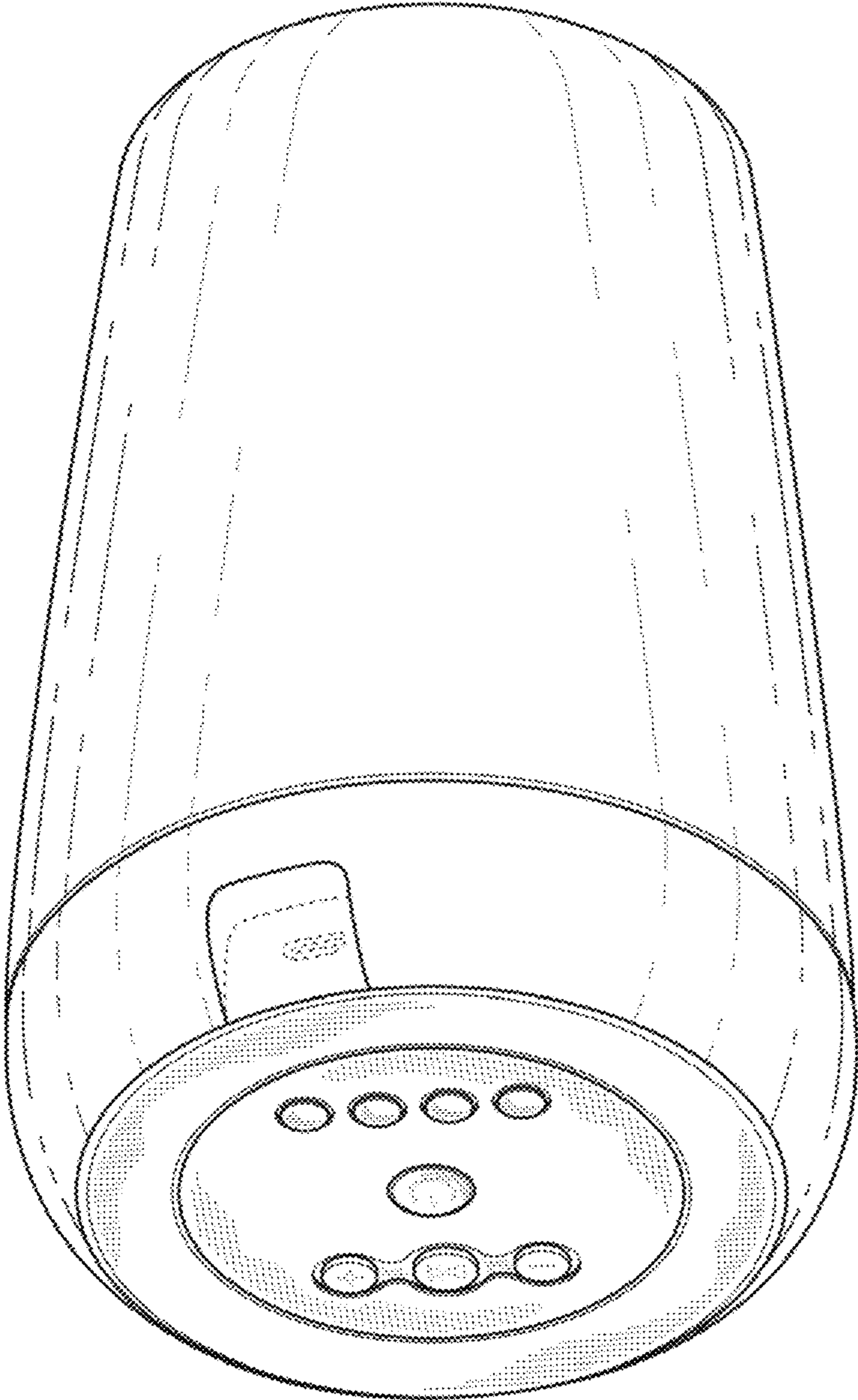

FIG. 3

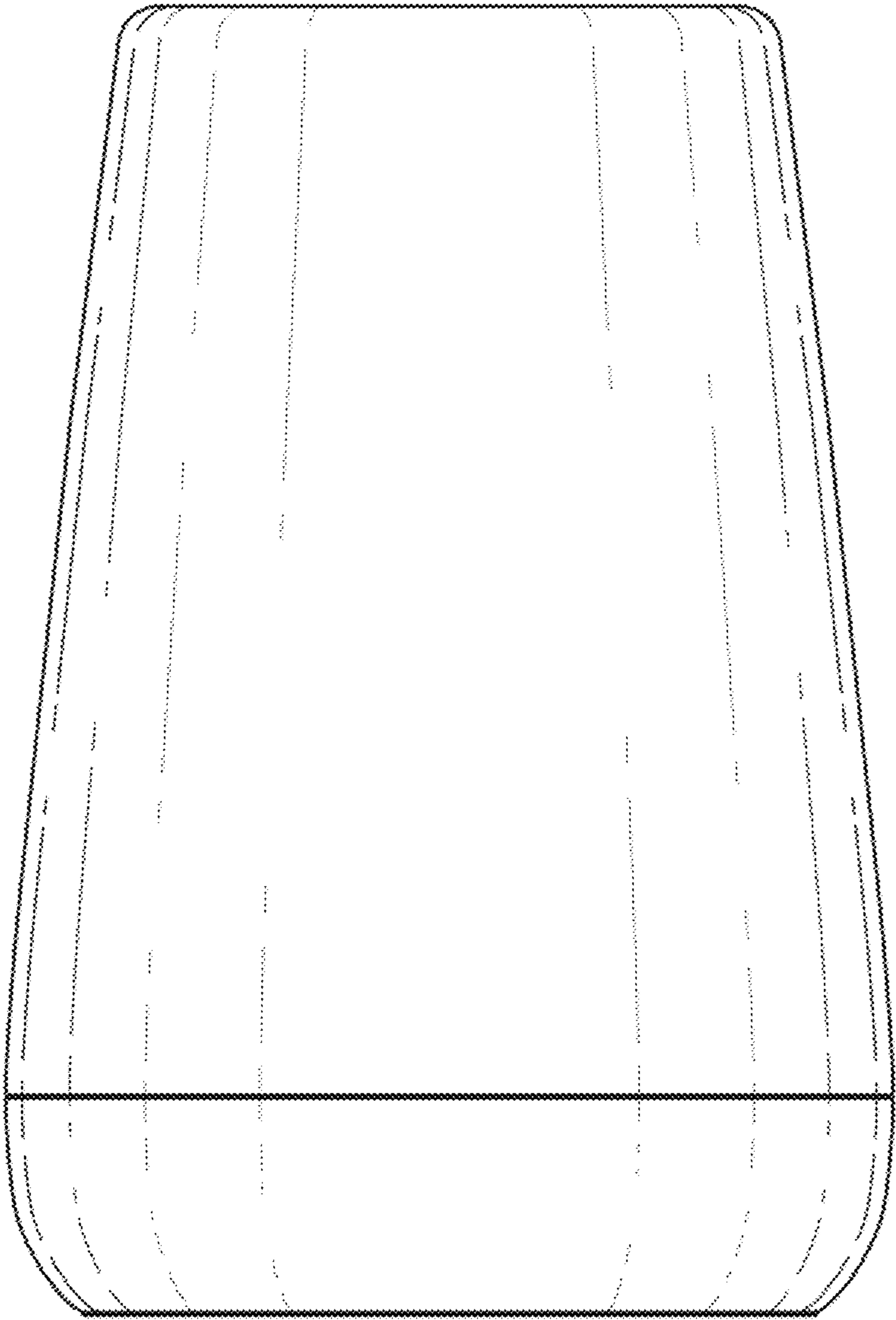

FIG. 4

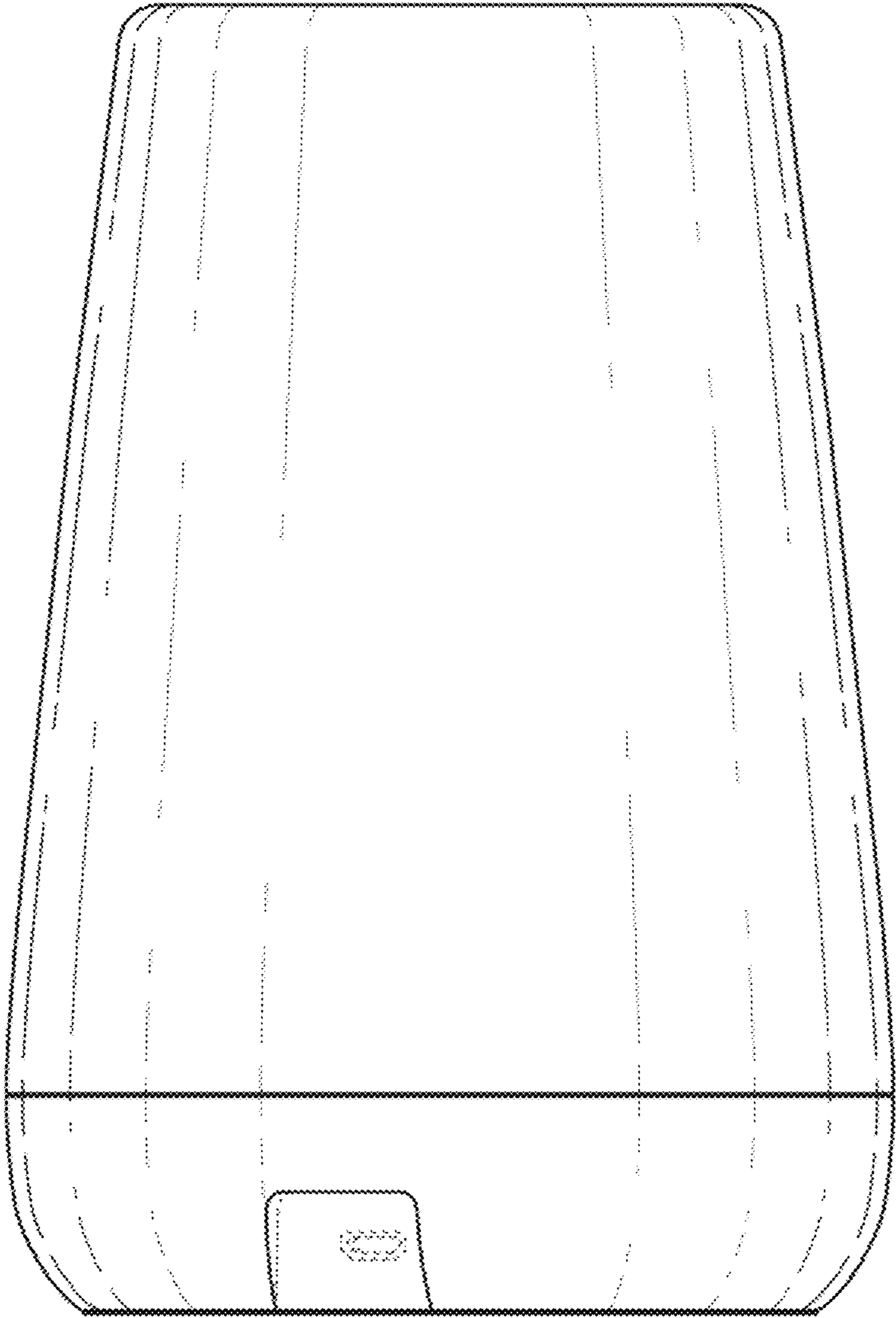

FIG. 5

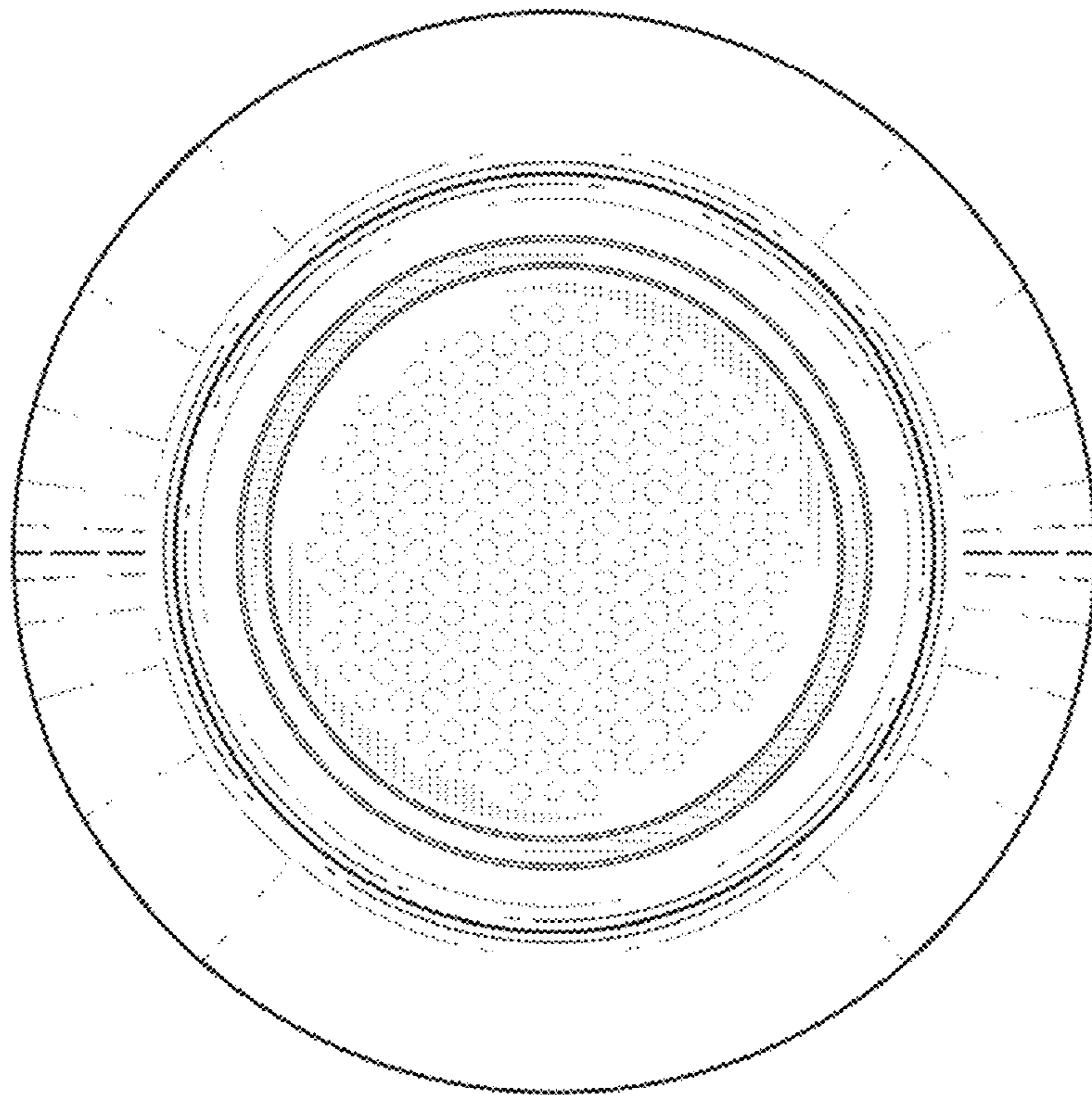

FIG. 6

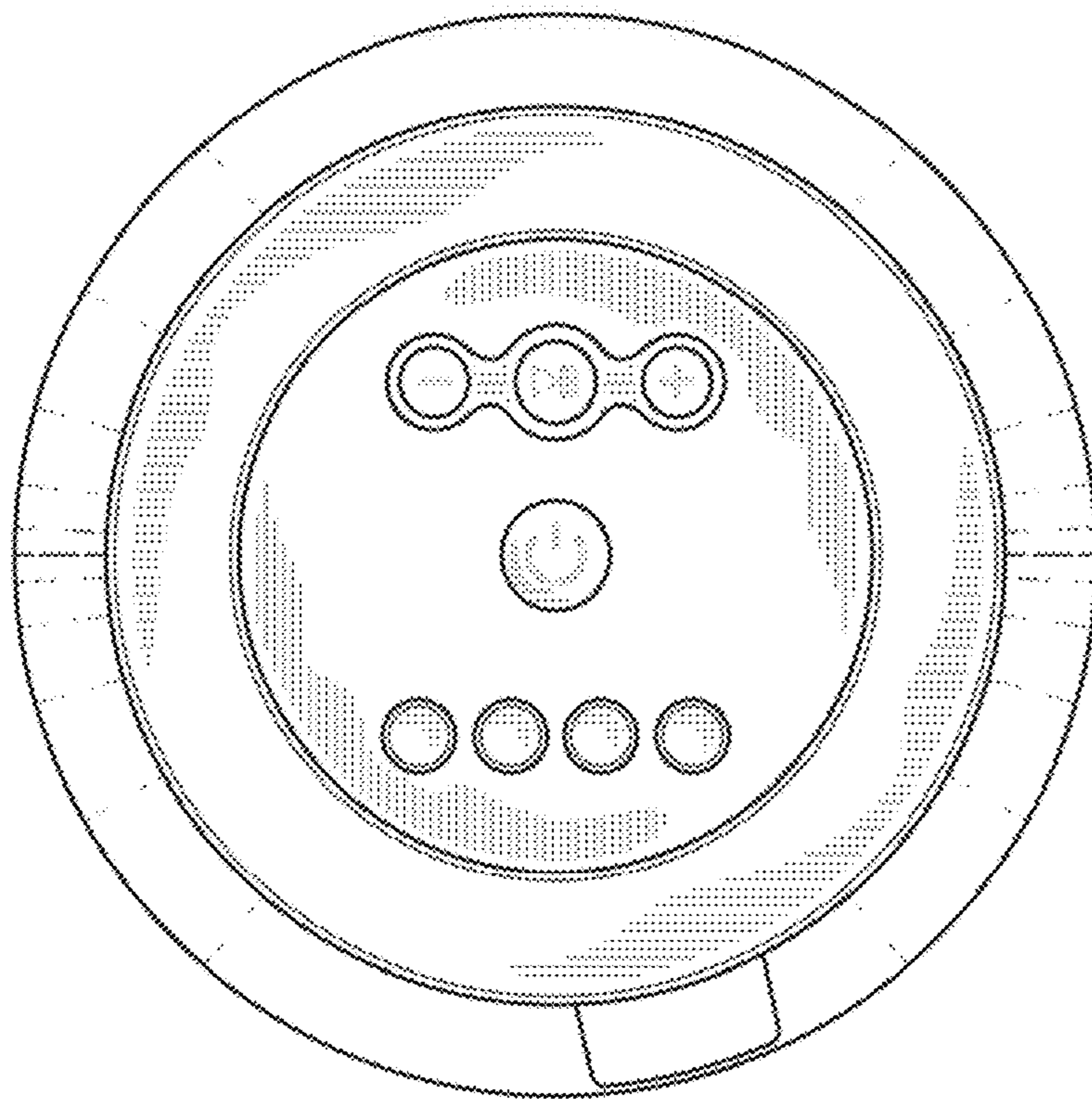

FIG. 7