



US00D835529S

(12) **United States Design Patent** (10) **Patent No.:** **US D835,529 S**
Logue (45) **Date of Patent:** **** Dec. 11, 2018**

(54) **MEASURING SCOOP**

(71) Applicant: **LOGUE AND CO. PTY LTD., AS TRUSTEE FOR A.T. & L.M. LOGUE FAMILY TRUST**, Yowie Bay, NSW (AU)

(72) Inventor: **Anthony Thomas Logue**, Yowie Bay (AU)

(73) Assignee: **LOGUE AND CO. PTY LTD.**, Yowie Bay, NSW (AU), AS TRUSTEE FOR A.T. & L.M. LOGUE FAMILY TRUST

(**) Term: **15 Years**

(21) Appl. No.: **29/564,452**

(22) Filed: **May 13, 2016**

(30) **Foreign Application Priority Data**

Nov. 15, 2015 (AU) 16133/2015
Nov. 15, 2015 (AU) 16134/2015
(Continued)

(51) **LOC (11) Cl.** **10-04**

(52) **U.S. Cl.**
USPC **D10/46.2; D9/447**

(58) **Field of Classification Search**
USPC D10/46.2, 46.3, 96, 101; D9/435, 436, D9/440, 447; D24/116; D7/392, 396.2,
(Continued)

(56) **References Cited**

U.S. PATENT DOCUMENTS

202,268 A * 4/1878 Keller B65D 41/26
141/381
535,125 A * 3/1895 Vincent B65D 41/26
141/381

(Continued)

Primary Examiner — Susan Bennett Hattan

Assistant Examiner — Brett Miller

(74) *Attorney, Agent, or Firm* — Sughrue Mion, PLLC

(57) **CLAIM**

The ornamental design for a measuring scoop, as shown and described.

DESCRIPTION

FIG. 1 is a front perspective view of a first embodiment of my design;

FIG. 2 is a front view thereof;

FIG. 3 is rear view thereof;

FIG. 4 is right side view thereof;

FIG. 5 is left side view thereof;

FIG. 6 is top view thereof;

FIG. 7 is bottom view thereof;

FIG. 8 is a front perspective view of a second embodiment of my design;

FIG. 9 is a front view thereof;

FIG. 10 is rear view thereof;

FIG. 11 is right side view thereof;

FIG. 12 is left side view thereof;

FIG. 13 is top view thereof;

FIG. 14 is bottom view thereof;

FIG. 15 is a front perspective view of a third embodiment of my design;

FIG. 16 is a front view thereof;

FIG. 17 is rear view thereof;

FIG. 18 is right side view thereof;

FIG. 19 is left side view thereof;

FIG. 20 is top view thereof;

FIG. 21 is bottom view thereof;

FIG. 22 is a front perspective view of a fourth embodiment of my design;

FIG. 23 is a front view thereof;

FIG. 24 is rear view thereof;

FIG. 25 is right side view thereof;

FIG. 26 is left side view thereof;

FIG. 27 is top view thereof;

FIG. 28 is bottom view thereof;

FIG. 29 is a front perspective view of a fifth embodiment of my design;

(Continued)

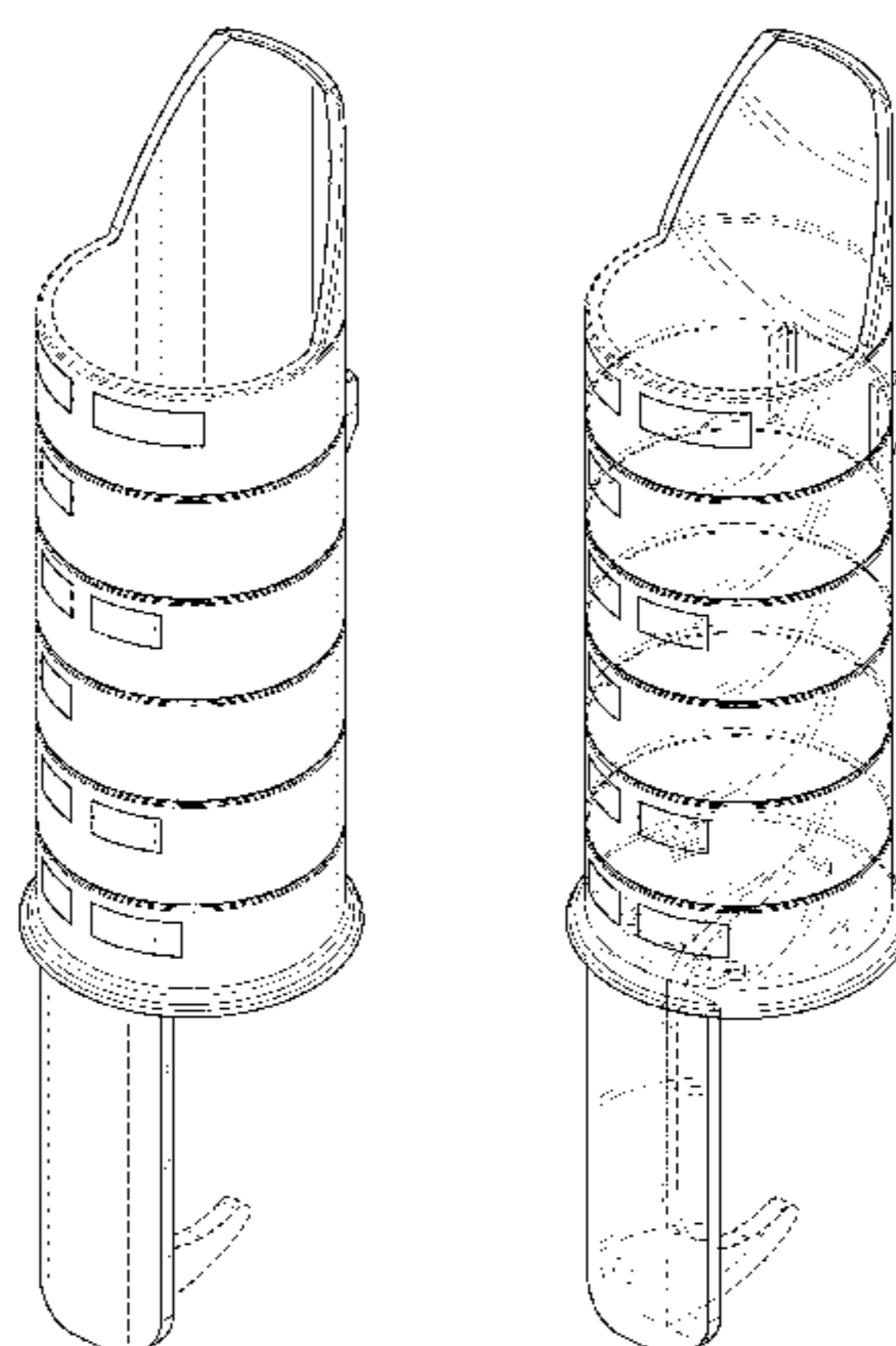

FIG. 30 is a front view thereof;
 FIG. 31 is rear view thereof;
 FIG. 32 is right side view thereof;
 FIG. 33 is left side view thereof;
 FIG. 34 is top view thereof;
 FIG. 35 is bottom view thereof;
 FIG. 36 is a front perspective view of a sixth embodiment of my design;
 FIG. 37 is a front view thereof;
 FIG. 38 is rear view thereof;
 FIG. 39 is right side view thereof;
 FIG. 40 is left side view thereof;
 FIG. 41 is top view thereof;
 FIG. 42 is bottom view thereof;
 FIG. 43 is a front perspective view of a seventh embodiment of my design;
 FIG. 44 is a front view thereof;
 FIG. 45 is rear view thereof;
 FIG. 46 is right side view thereof;
 FIG. 47 is left side view thereof;
 FIG. 48 is top view thereof;
 FIG. 49 is bottom view thereof;
 FIG. 50 is a front perspective view of an eighth embodiment of my design;
 FIG. 51 is a front view thereof;
 FIG. 52 is rear view thereof;
 FIG. 53 is right side view thereof;
 FIG. 54 is left side view thereof;
 FIG. 55 is top view thereof;
 FIG. 56 is bottom view thereof;
 FIG. 57 is a front perspective view of a ninth embodiment of my design;
 FIG. 58 is a front view thereof;
 FIG. 59 is rear view thereof;
 FIG. 60 is right side view thereof;
 FIG. 61 is left side view thereof;
 FIG. 62 is top view thereof;
 FIG. 63 is bottom view thereof;
 FIG. 64 is a front perspective view of a tenth embodiment of my design;
 FIG. 65 is a front view thereof;
 FIG. 66 is rear view thereof;
 FIG. 67 is right side view thereof;
 FIG. 68 is left side view thereof;
 FIG. 69 is top view thereof; and,
 FIG. 70 is bottom view thereof.

The broken lines shown in the drawings represent portions of the measuring scoop which form no part of the claimed design.

1 Claim, 40 Drawing Sheets

(30) **Foreign Application Priority Data**

Nov. 15, 2015 (AU) 16135/2015
 Nov. 15, 2015 (AU) 16136/2015
 Nov. 15, 2015 (AU) 16152/2015

(58) **Field of Classification Search**

USPC D7/397-398; 141/381; 222/566;
 220/717; 73/426, 427
 CPC B65D 41/26; B65D 47/06; G01F 19/00;
 G01F 19/002
 See application file for complete search history.

(56) **References Cited**

U.S. PATENT DOCUMENTS

1,419,580 A * 6/1922 Molinari G01F 19/00
 141/381
 1,648,512 A * 11/1927 Stock A47J 41/0083
 D9/447
 2,133,318 A * 10/1938 Arato A47G 19/2216
 220/717
 2,317,046 A * 4/1943 Fleming B65D 41/12
 220/717
 2,678,142 A * 5/1954 Creed B65D 47/06
 220/717
 3,045,723 A * 7/1962 Gainor B65D 51/247
 141/381
 D197,025 S * 12/1963 Marcus D10/46.2
 D252,371 S * 7/1979 Folli D10/46.2
 D276,555 S * 11/1984 Noble D10/46.2
 D332,577 S * 1/1993 Peterson D10/101
 5,377,879 A * 1/1995 Isaacs G01F 19/002
 D10/46.2
 D366,840 S * 2/1996 Schagerstrom D10/46.2
 D419,090 S * 1/2000 Folos D10/101
 D612,237 S * 3/2010 Richey D9/447
 D686,076 S * 7/2013 Traxler D9/447
 D720,241 S * 12/2014 Logue D10/46.2
 D777,031 S * 1/2017 Katopis D9/436
 D781,645 S * 3/2017 Lau D7/397
 2004/0140315 A1 * 7/2004 Reinoso B65D 47/06
 220/717
 2015/0284150 A1 * 10/2015 Doubles B65D 41/26
 222/1

* cited by examiner

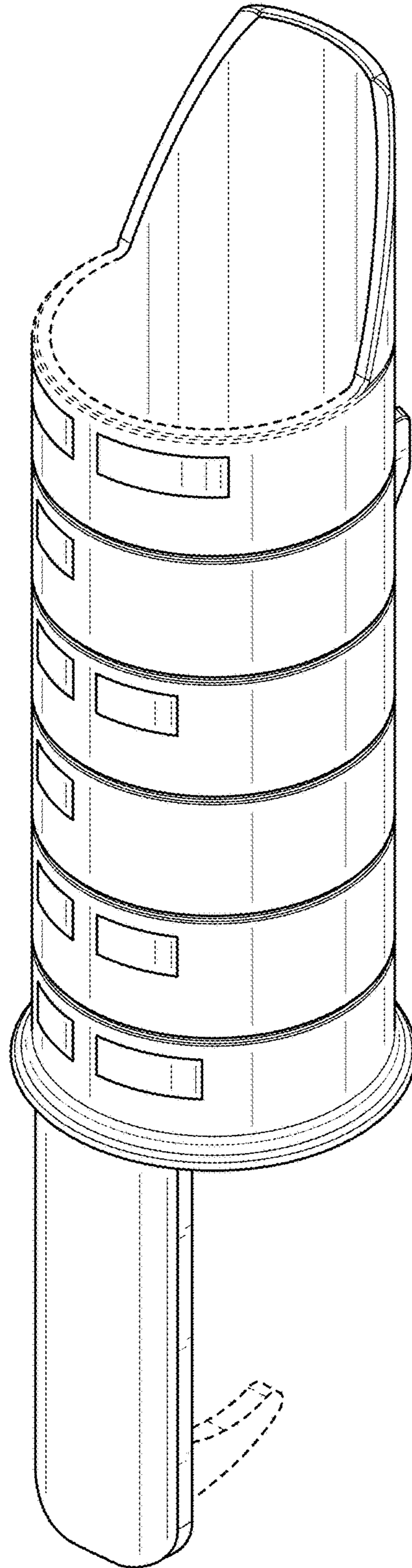

FIG. 1

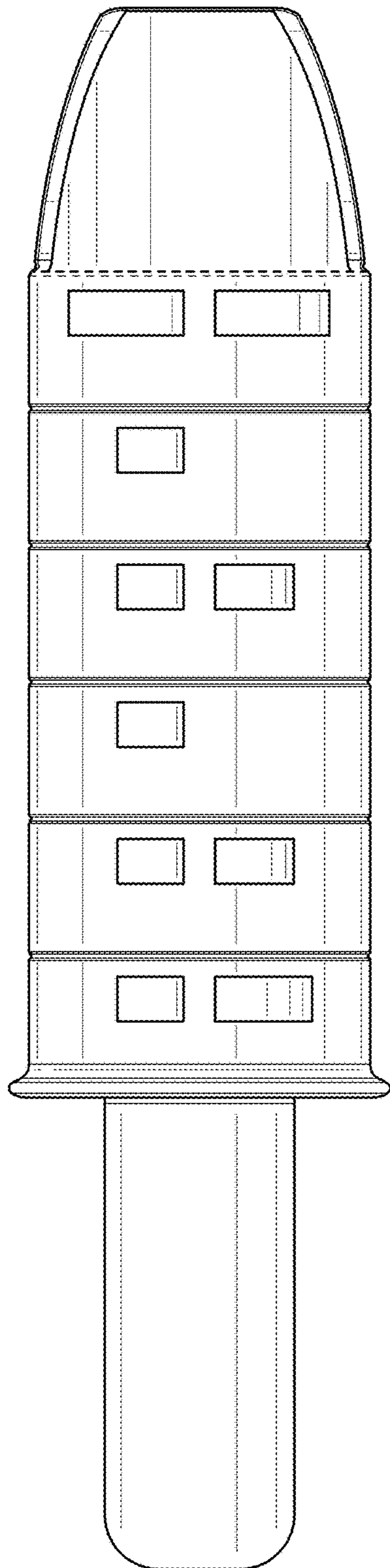

FIG. 2

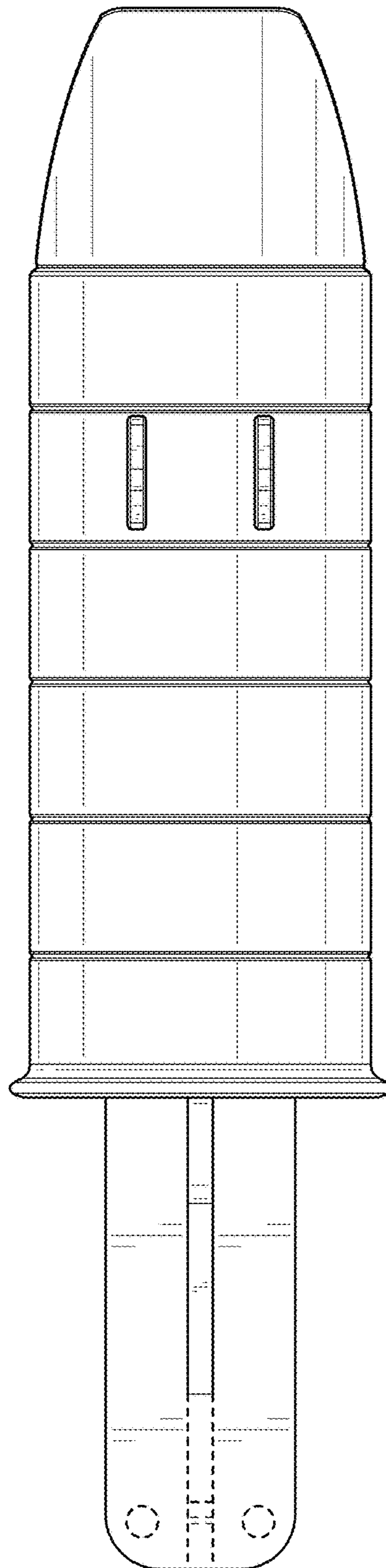

FIG. 3

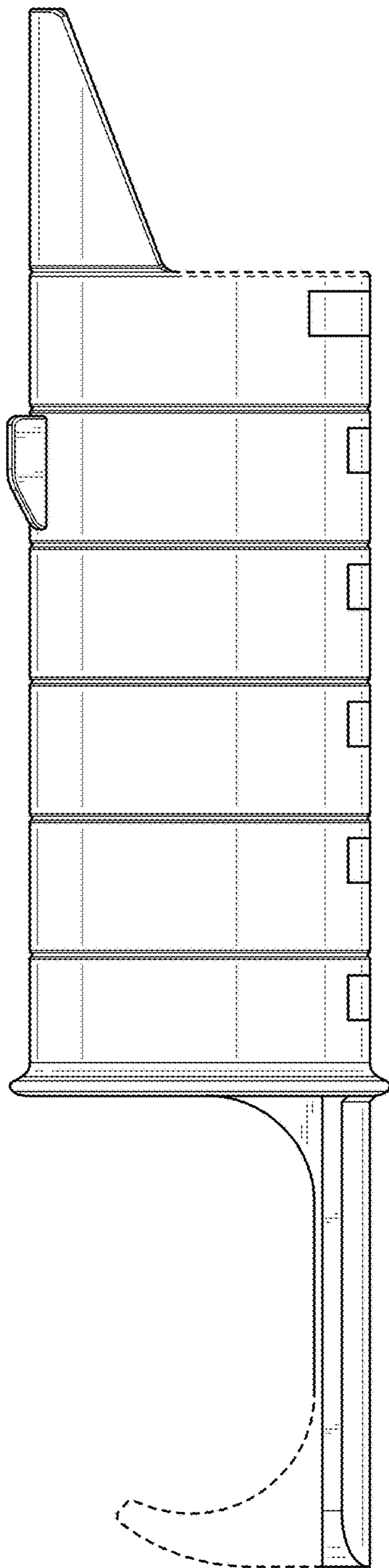

FIG. 4

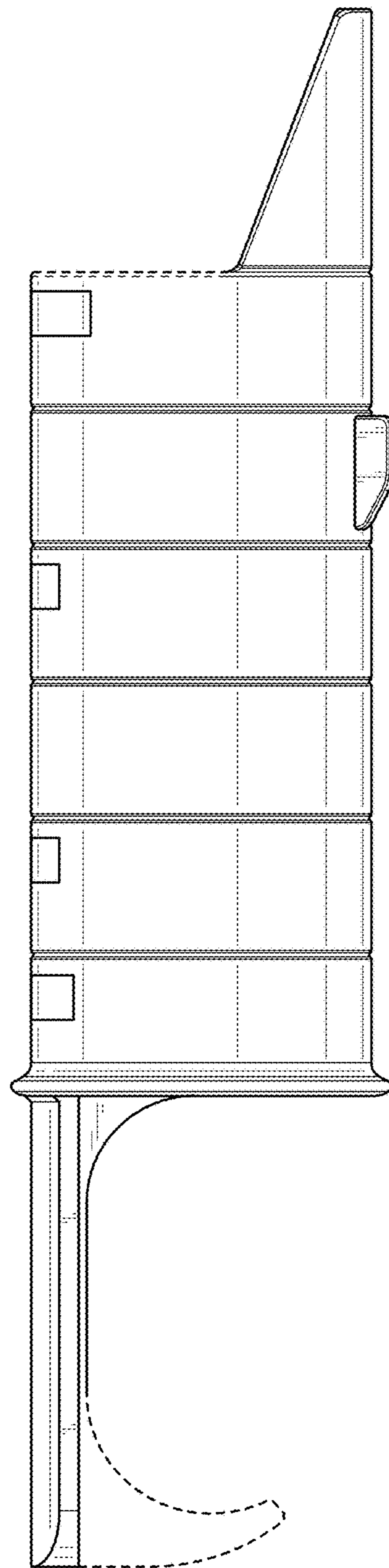

FIG. 5

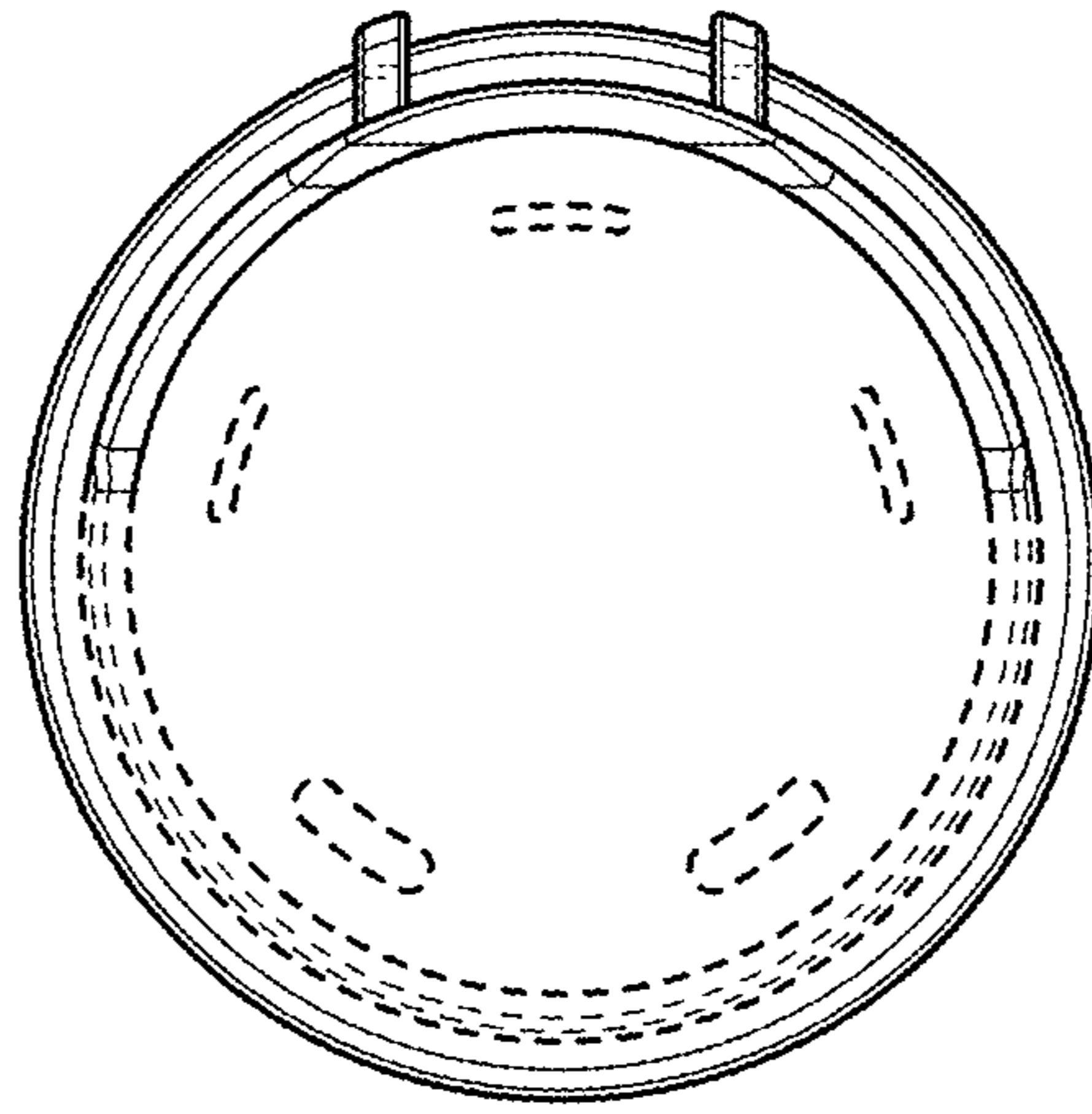

FIG. 6

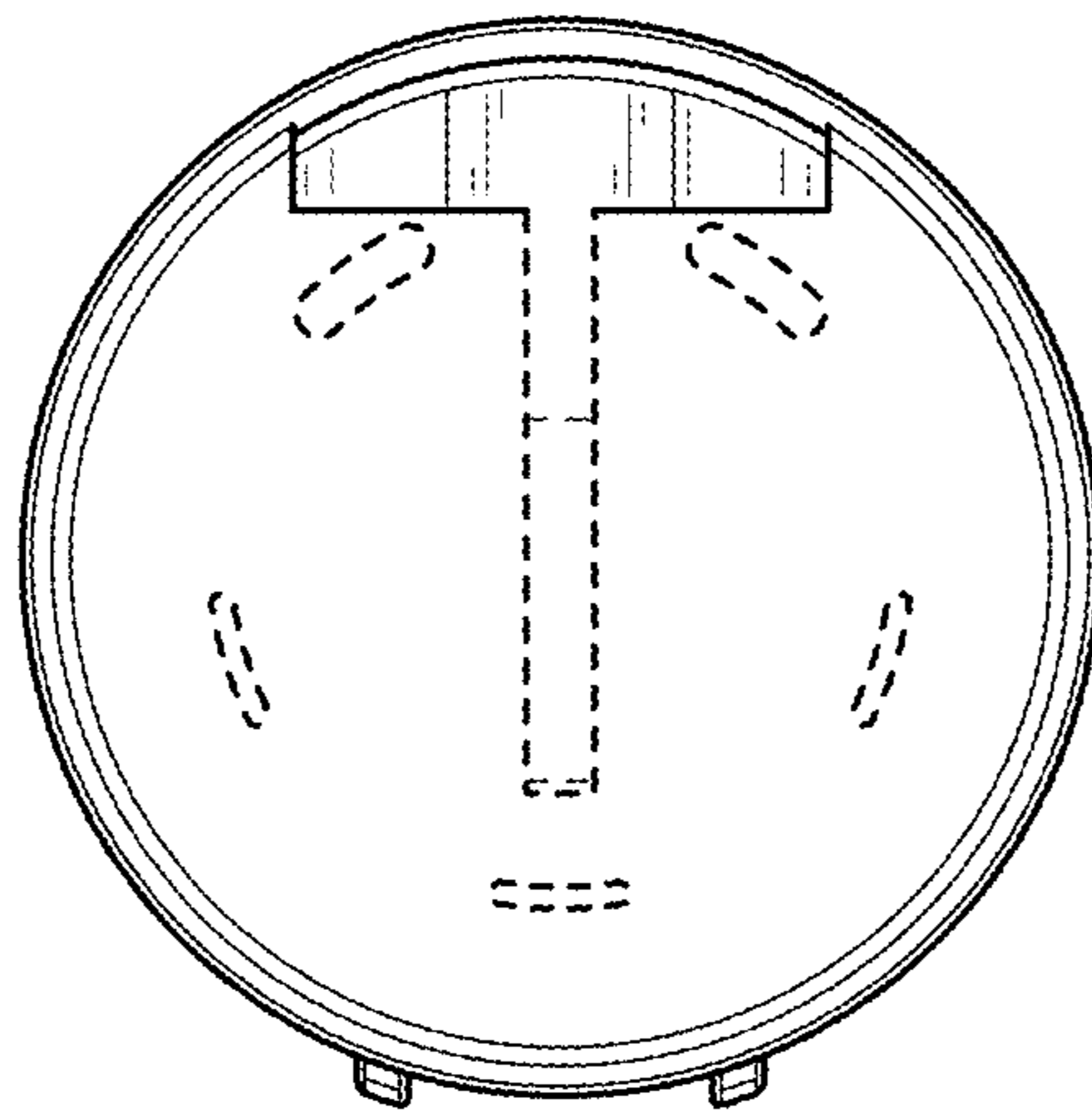

FIG. 7

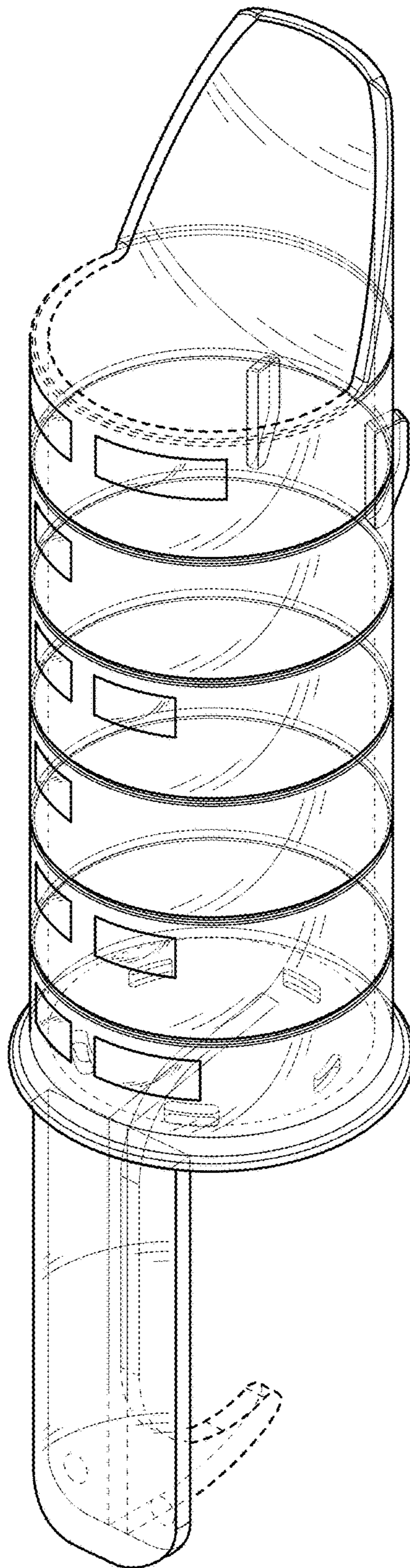

FIG. 8

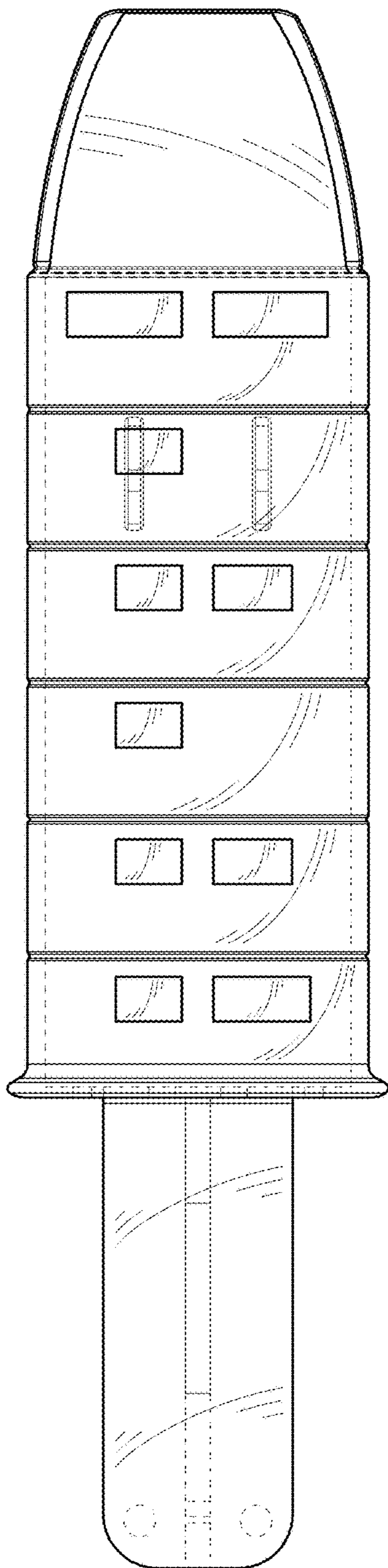

FIG. 9

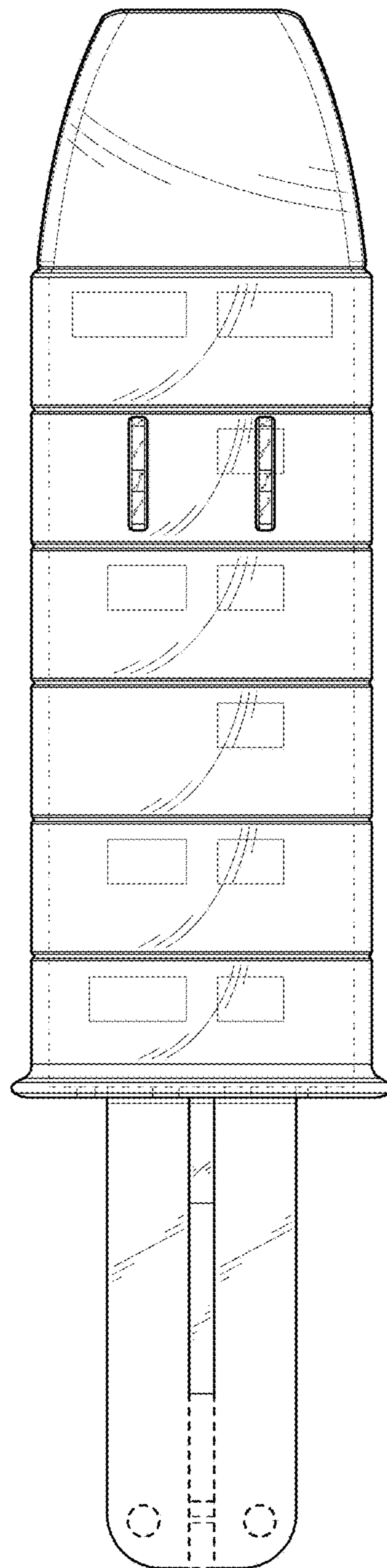

FIG. 10

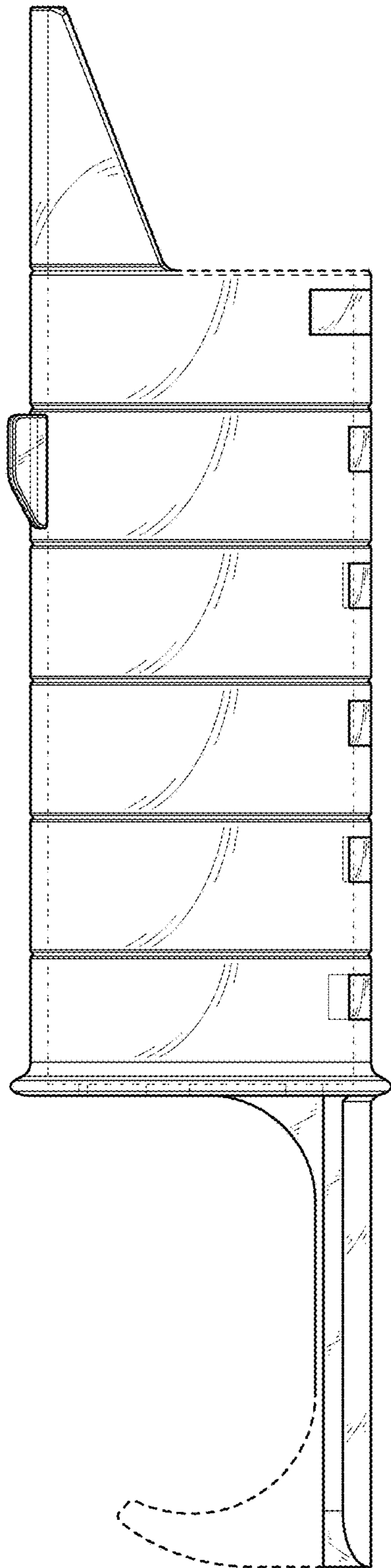

FIG. 11

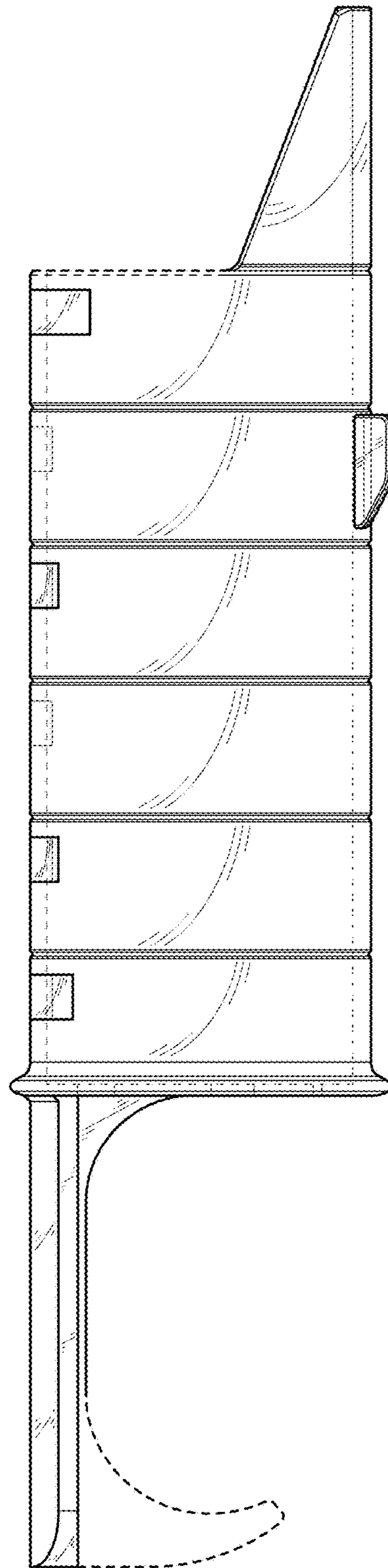

FIG. 12

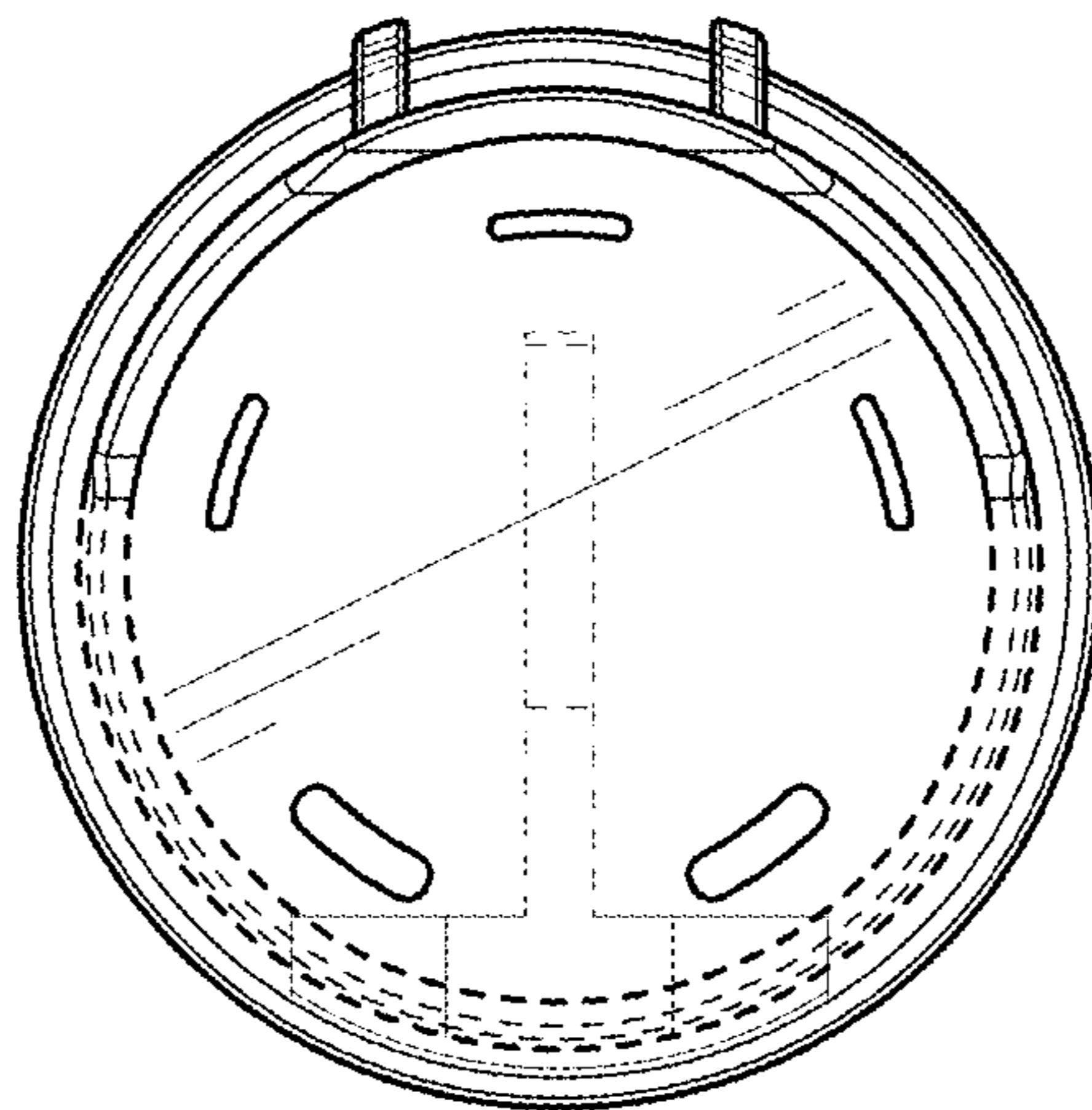

FIG. 13

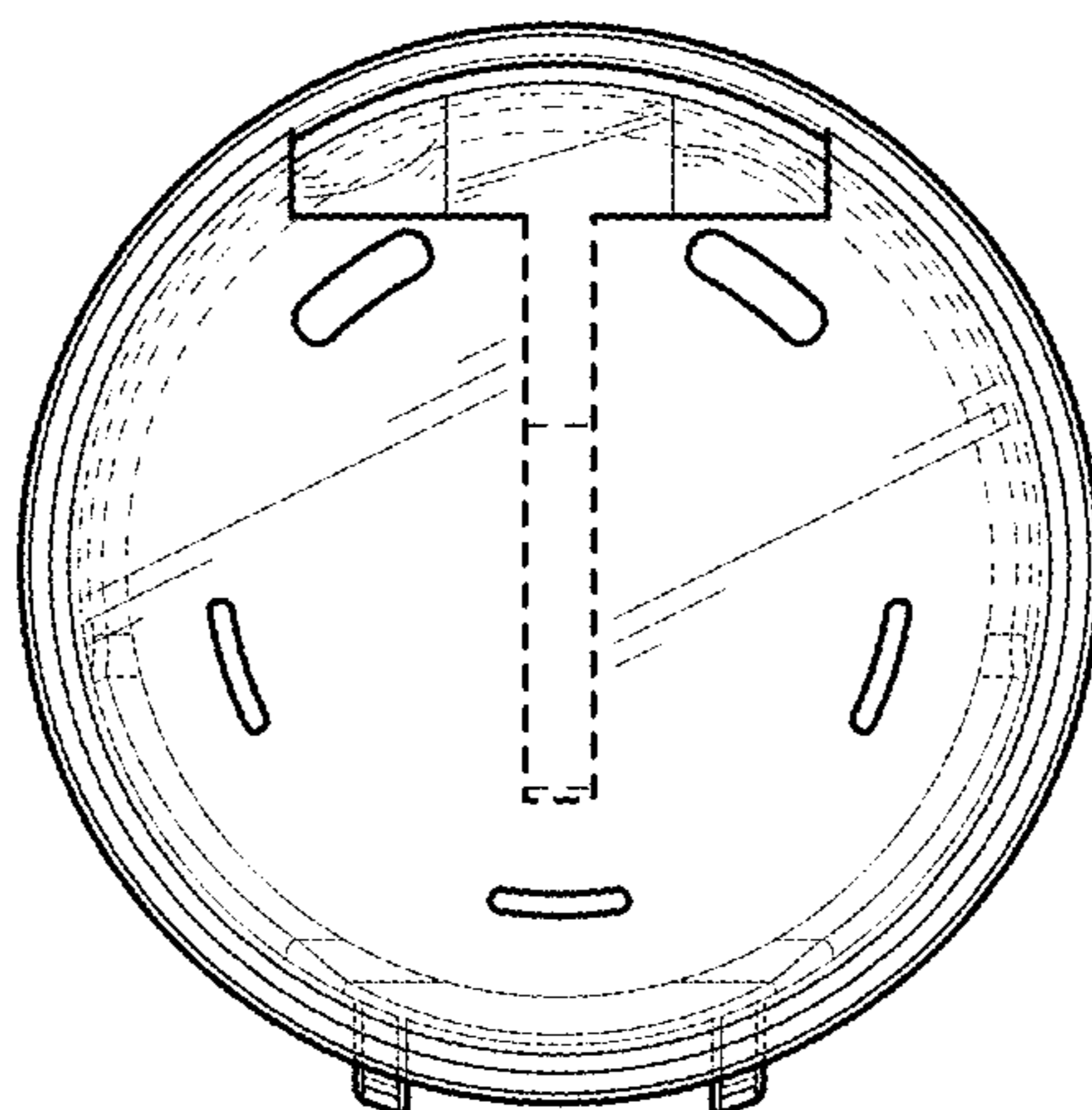

FIG. 14

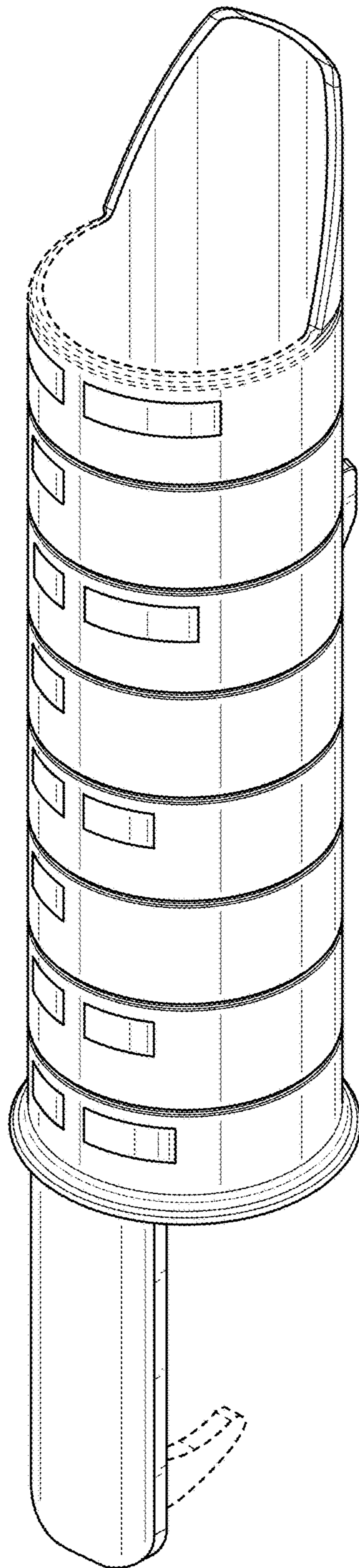

FIG. 15

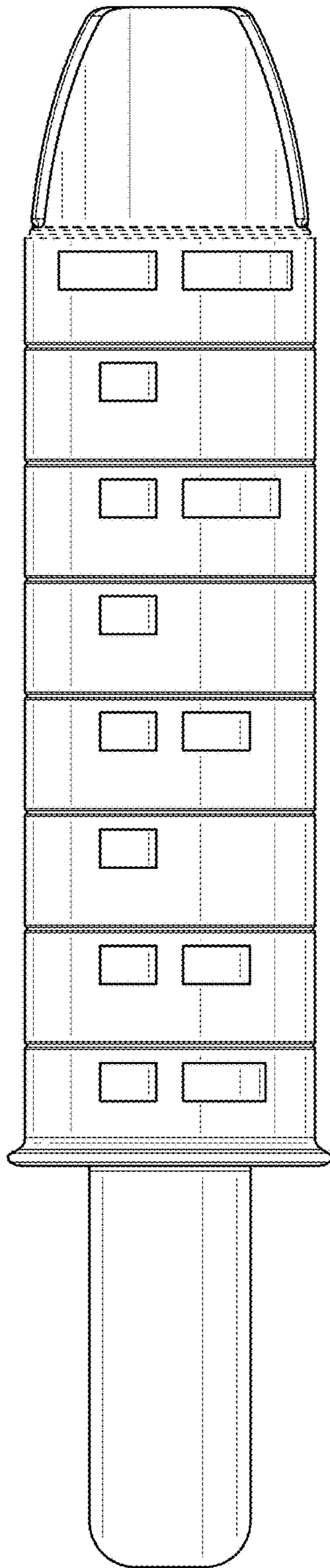

FIG. 16

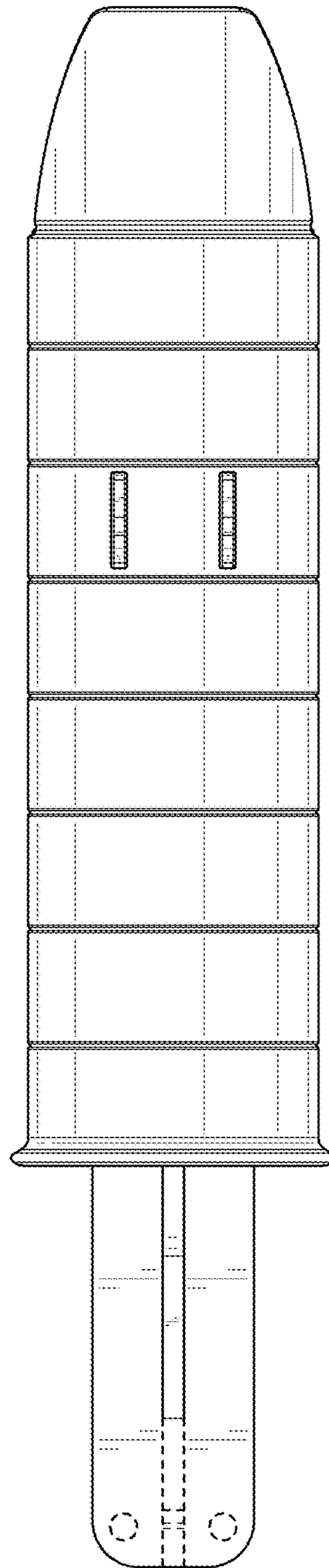

FIG. 17

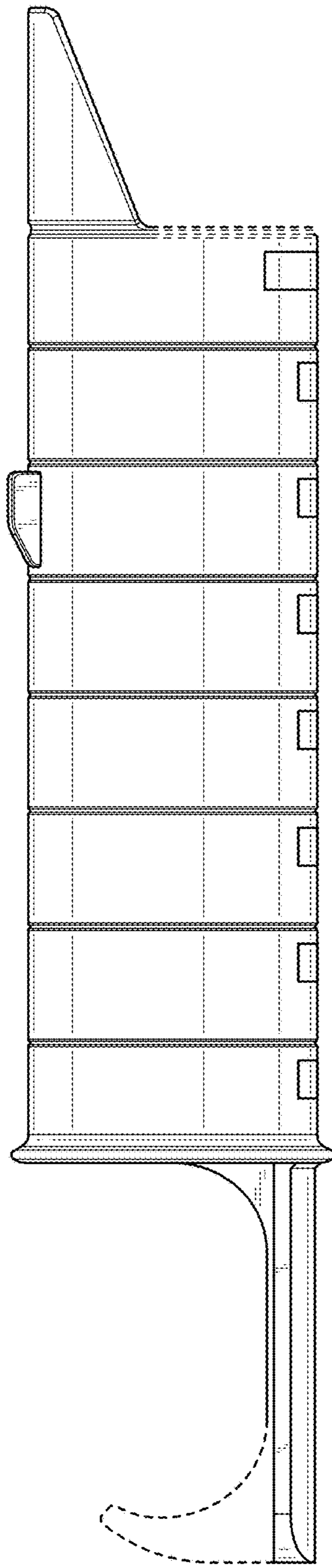

FIG. 18

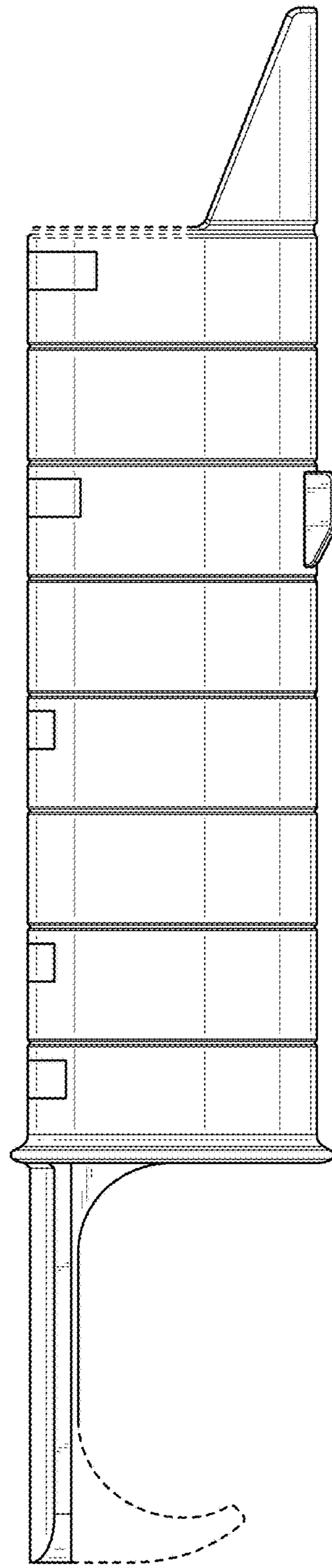

FIG. 19

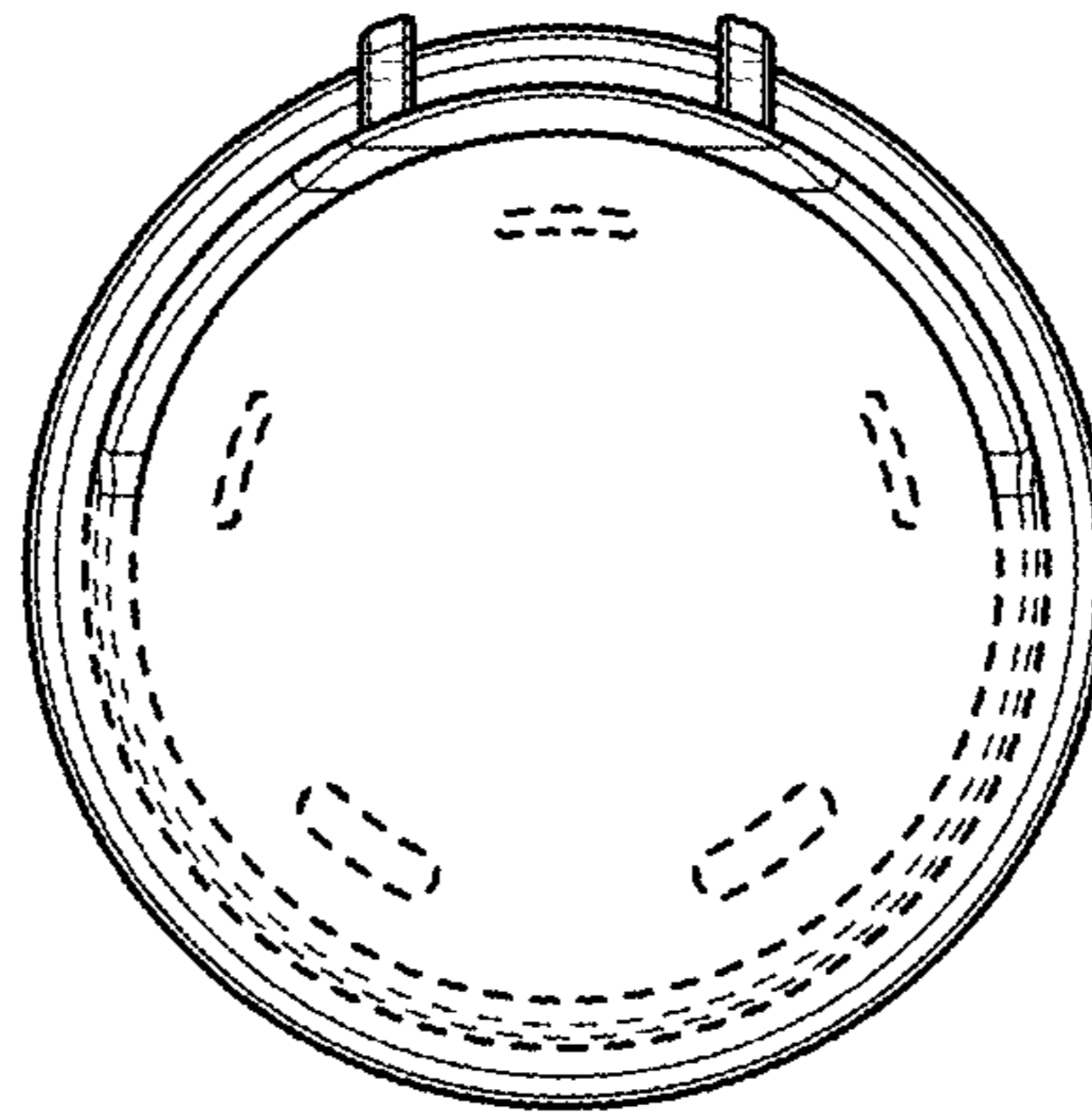

FIG. 20

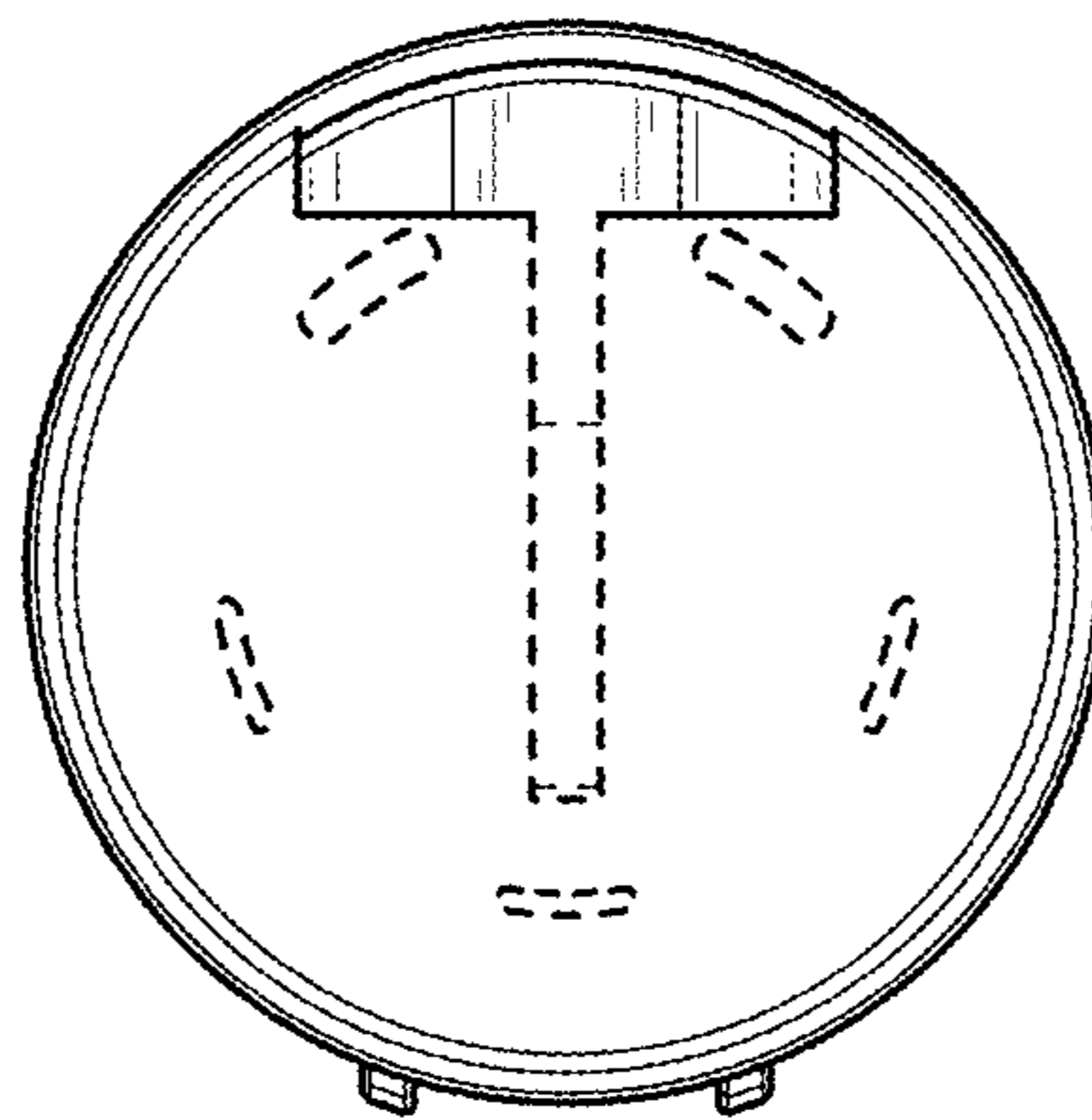

FIG. 21

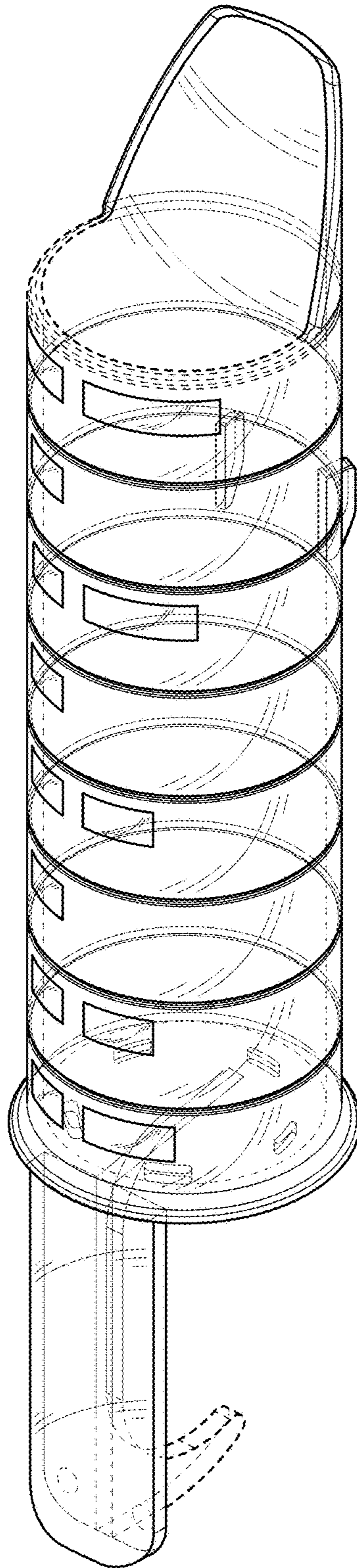

FIG. 22

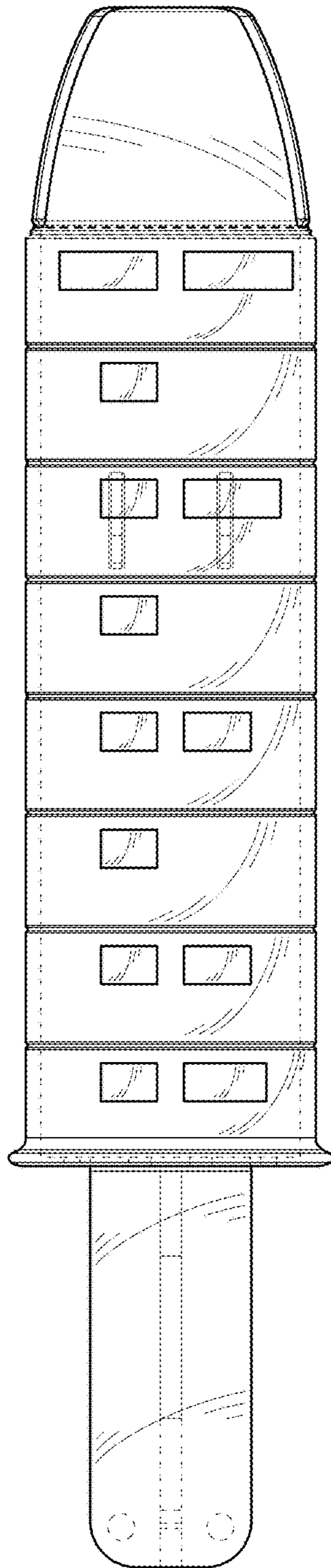

FIG. 23

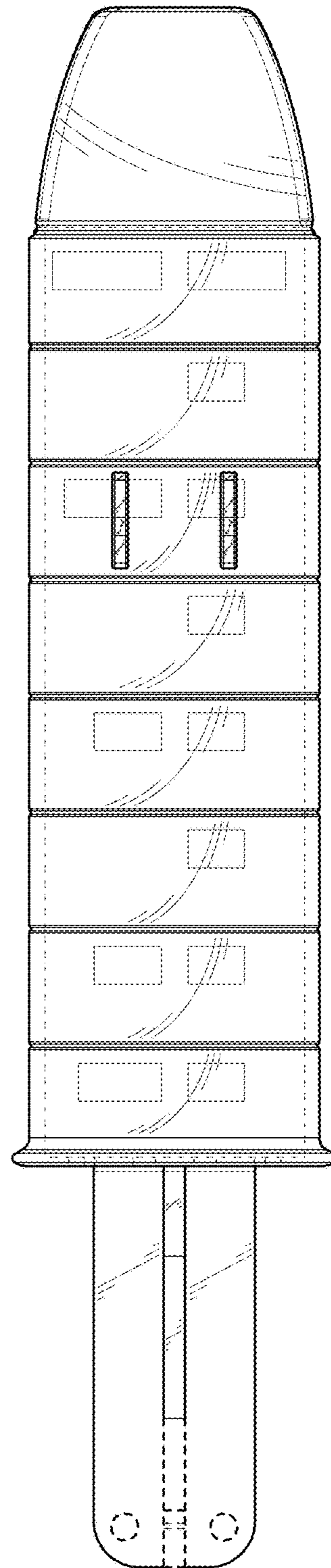

FIG. 24

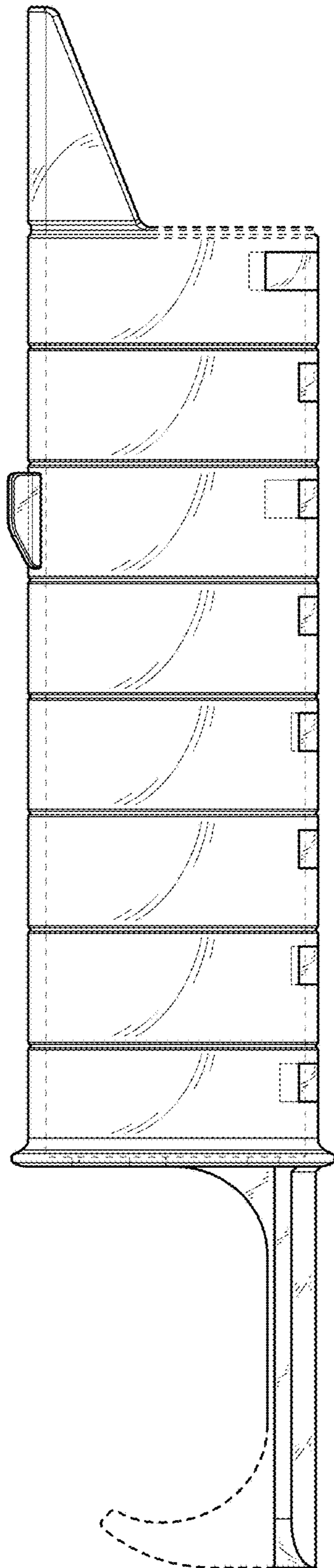

FIG. 25

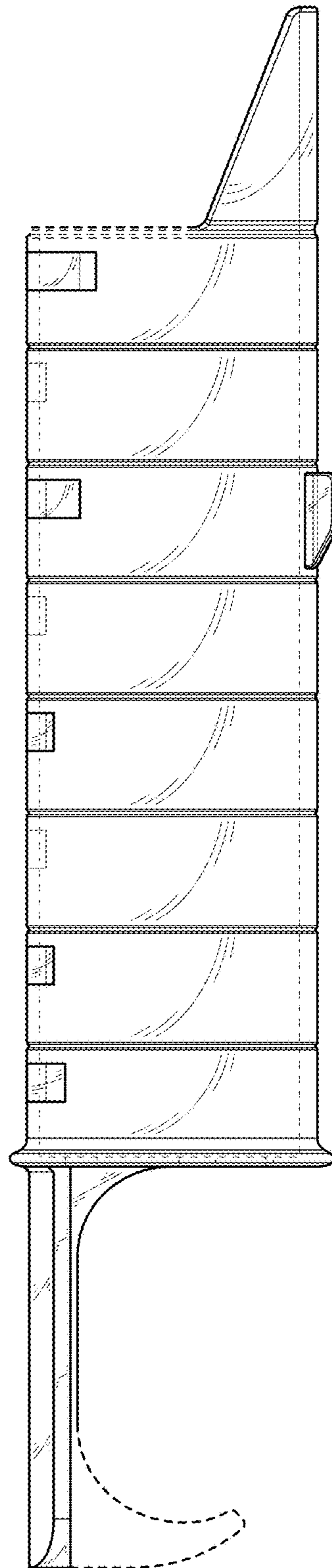

FIG. 26

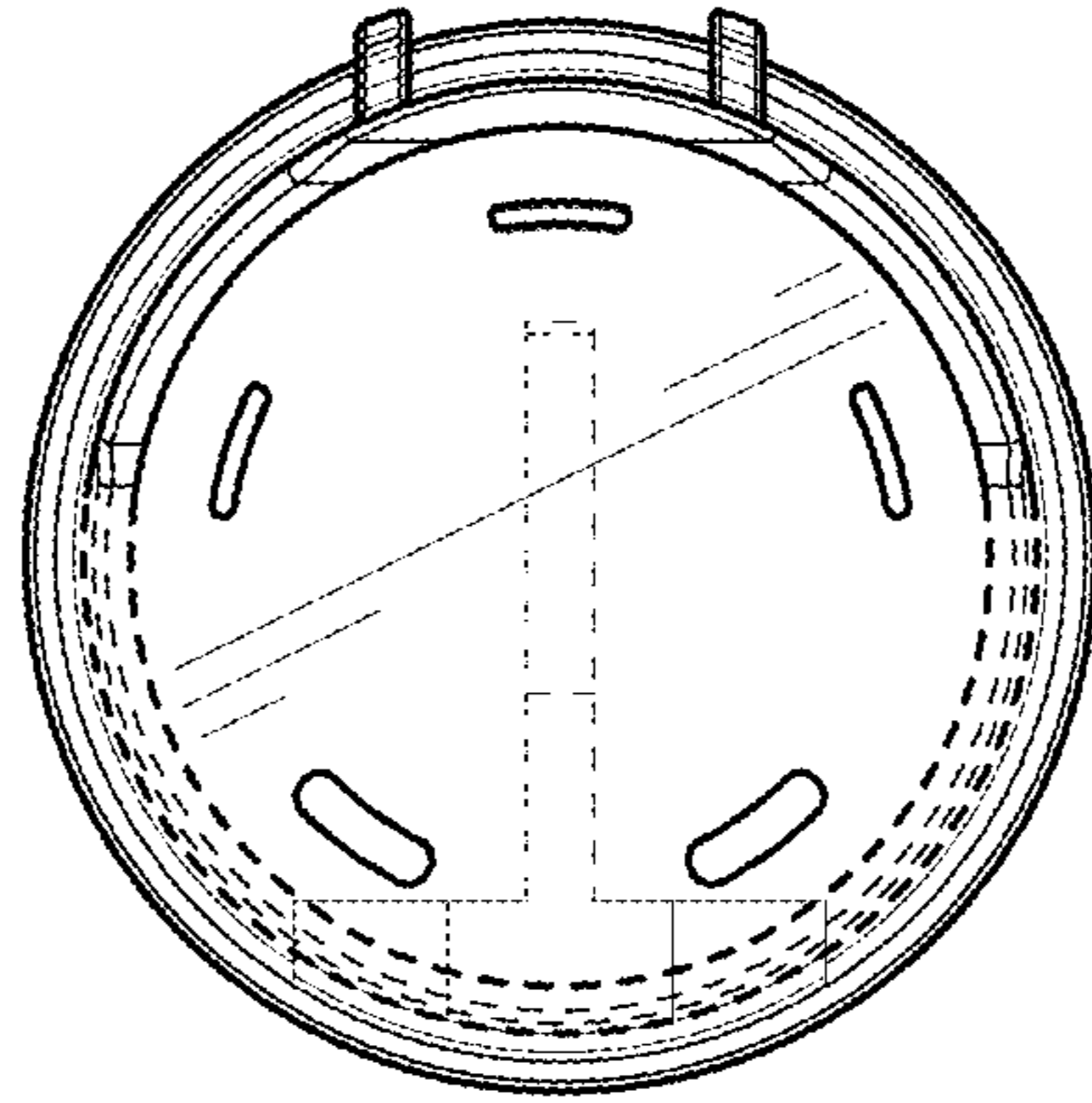

FIG. 27

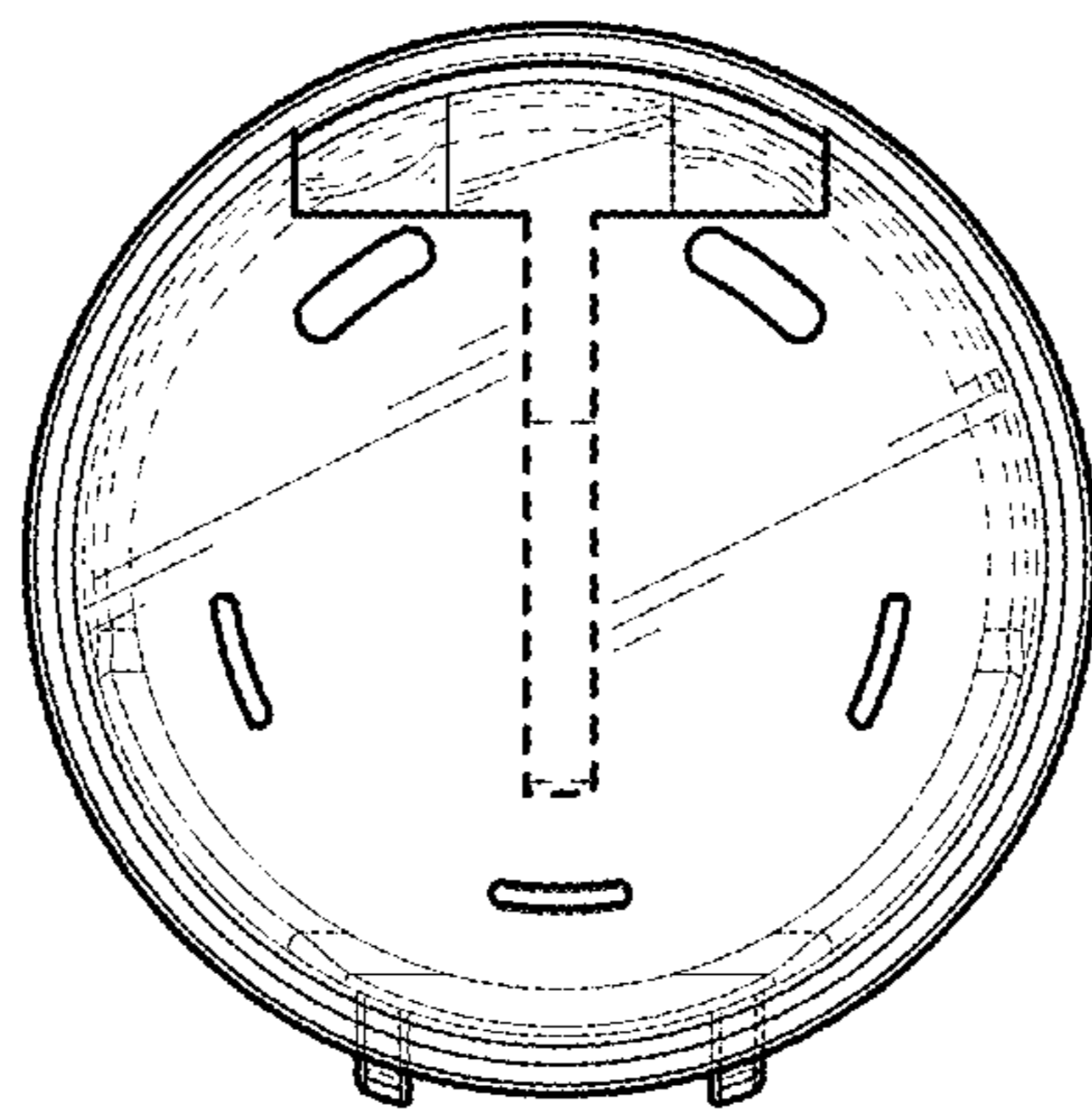

FIG. 28

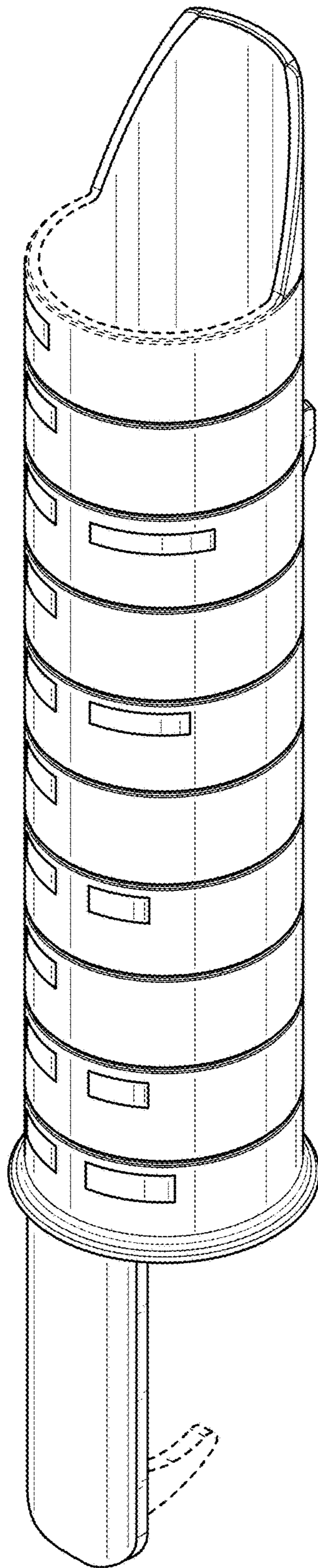

FIG. 29

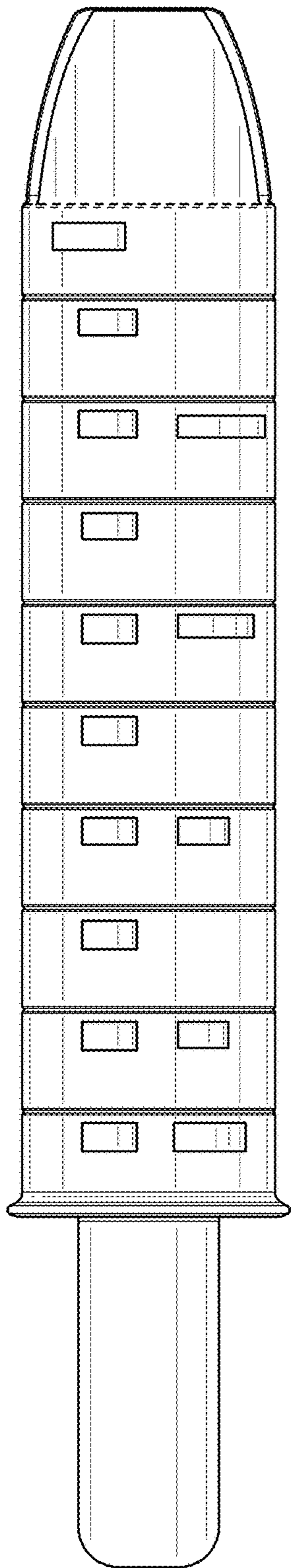

FIG. 30

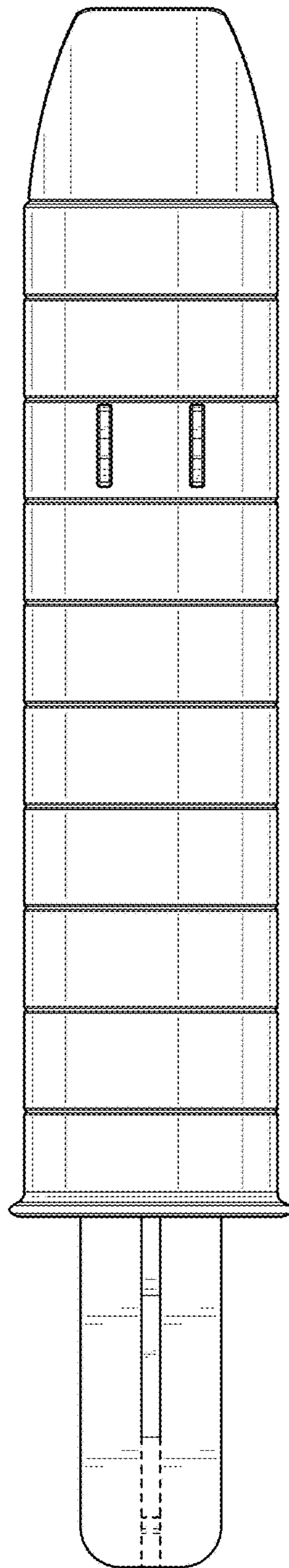

FIG. 31

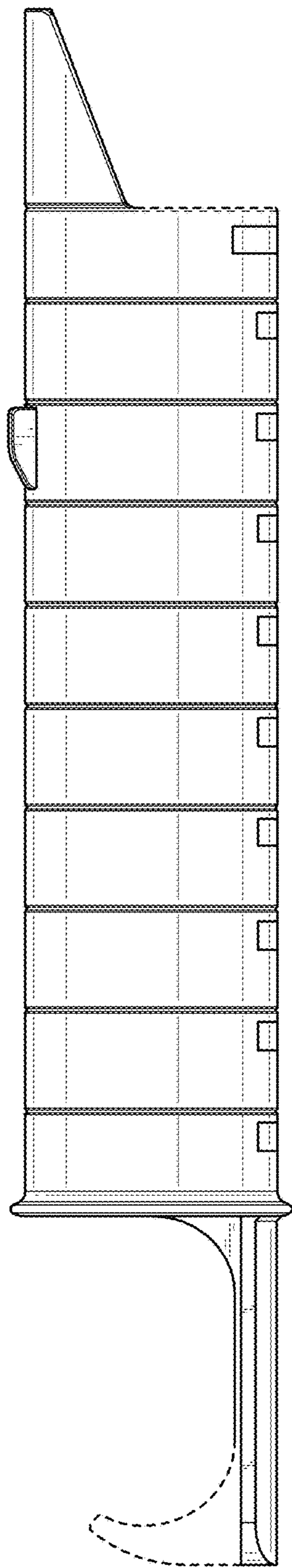

FIG. 32

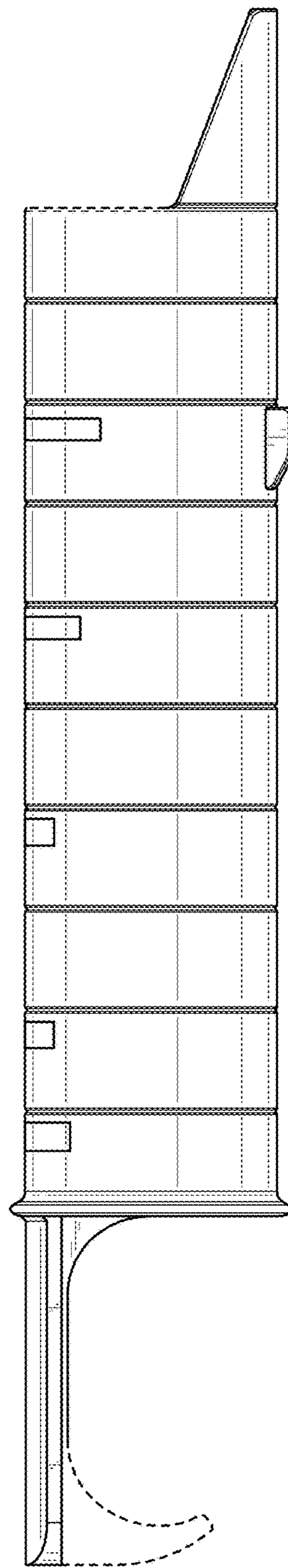

FIG. 33

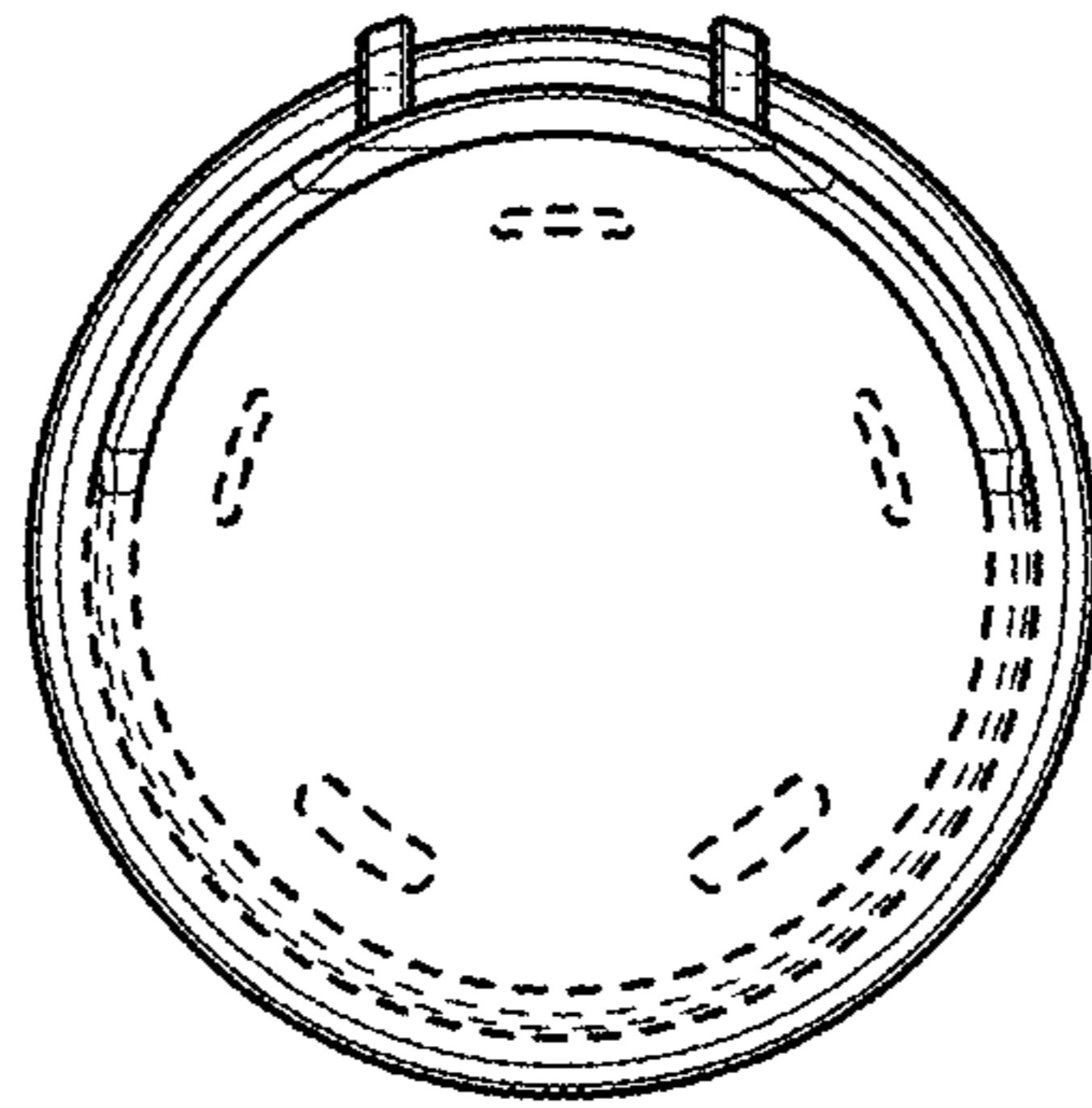

FIG. 34

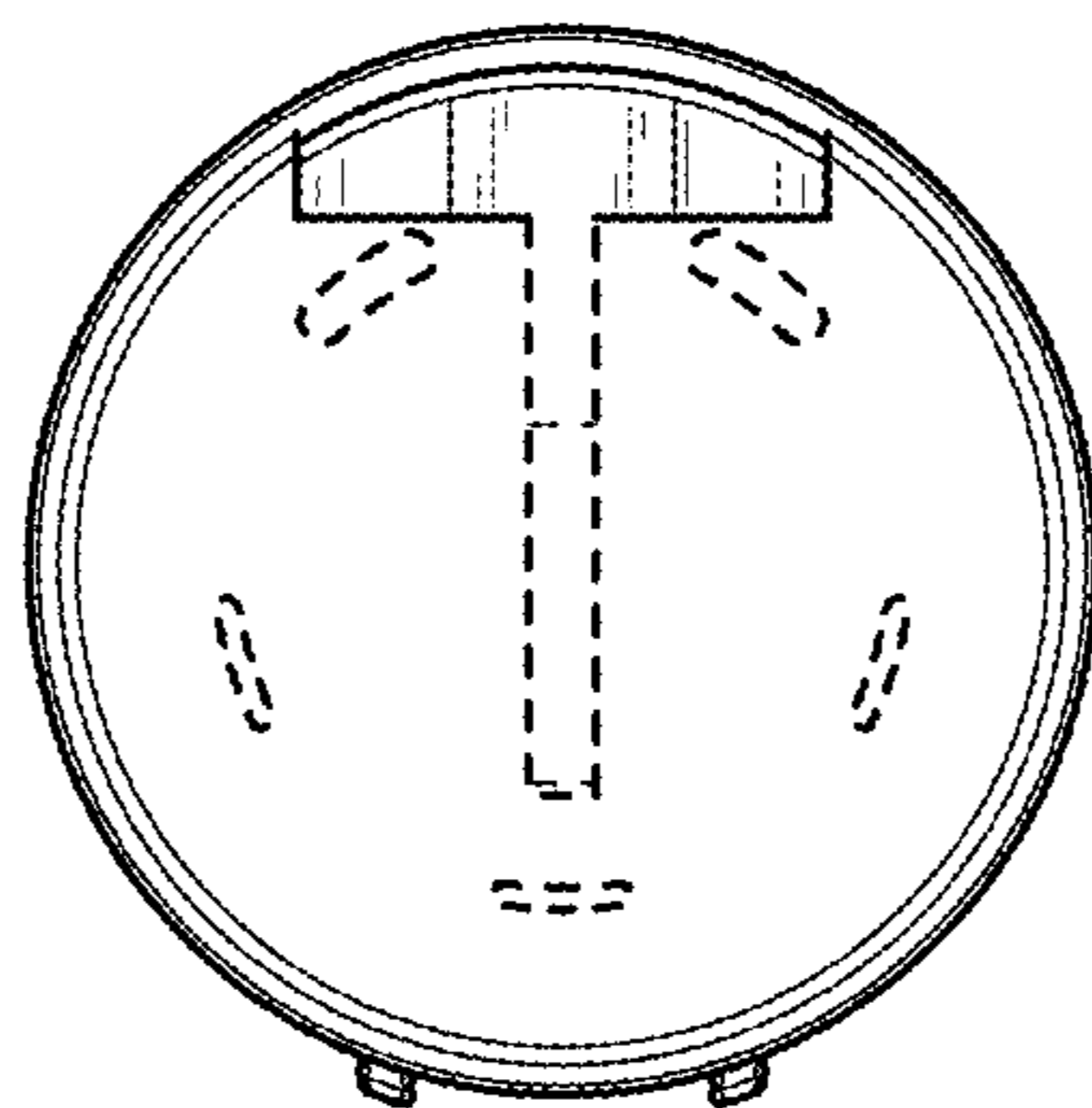

FIG. 35

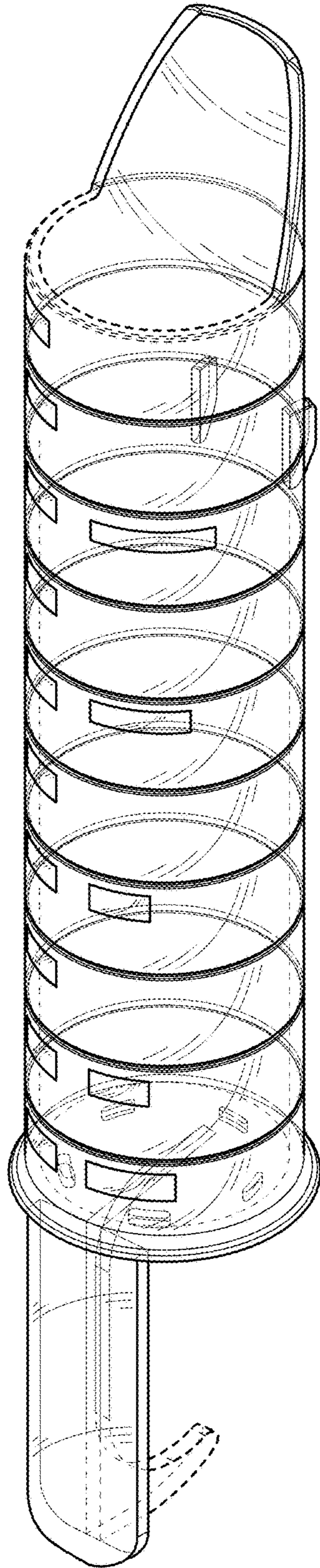

FIG. 36

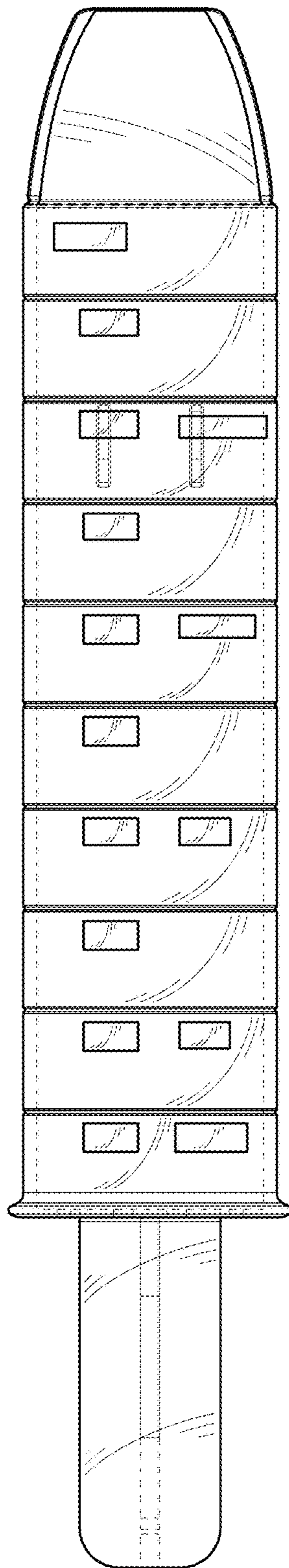

FIG. 37

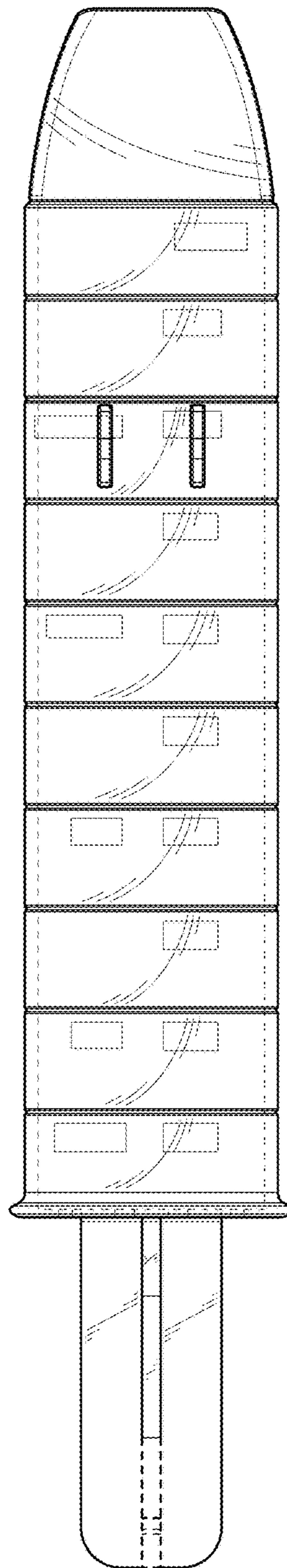

FIG. 38

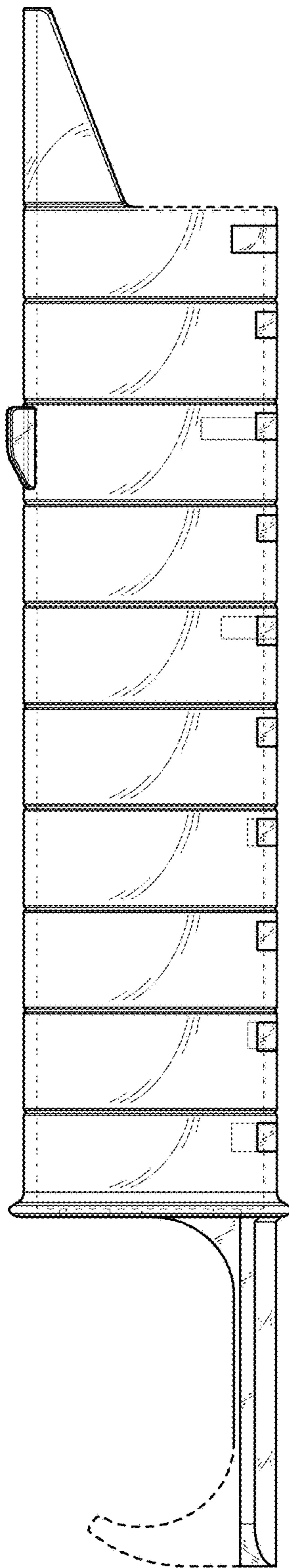

FIG. 39

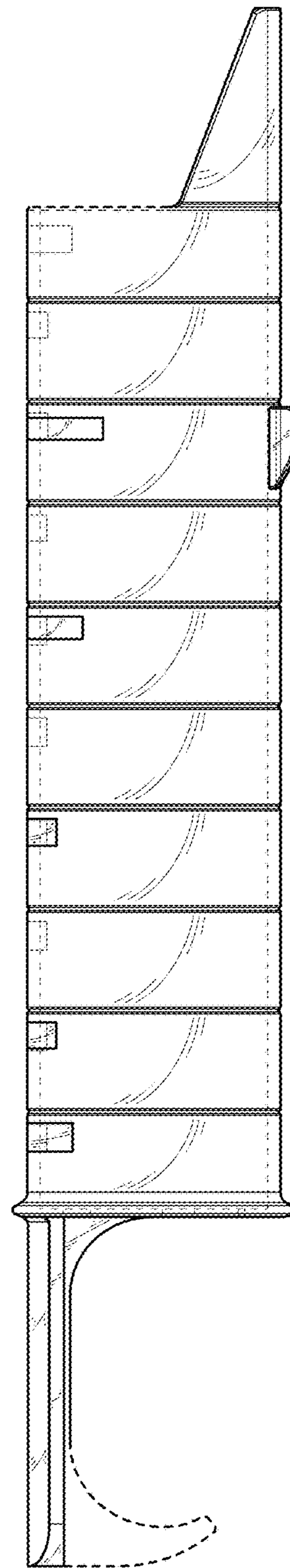

FIG. 40

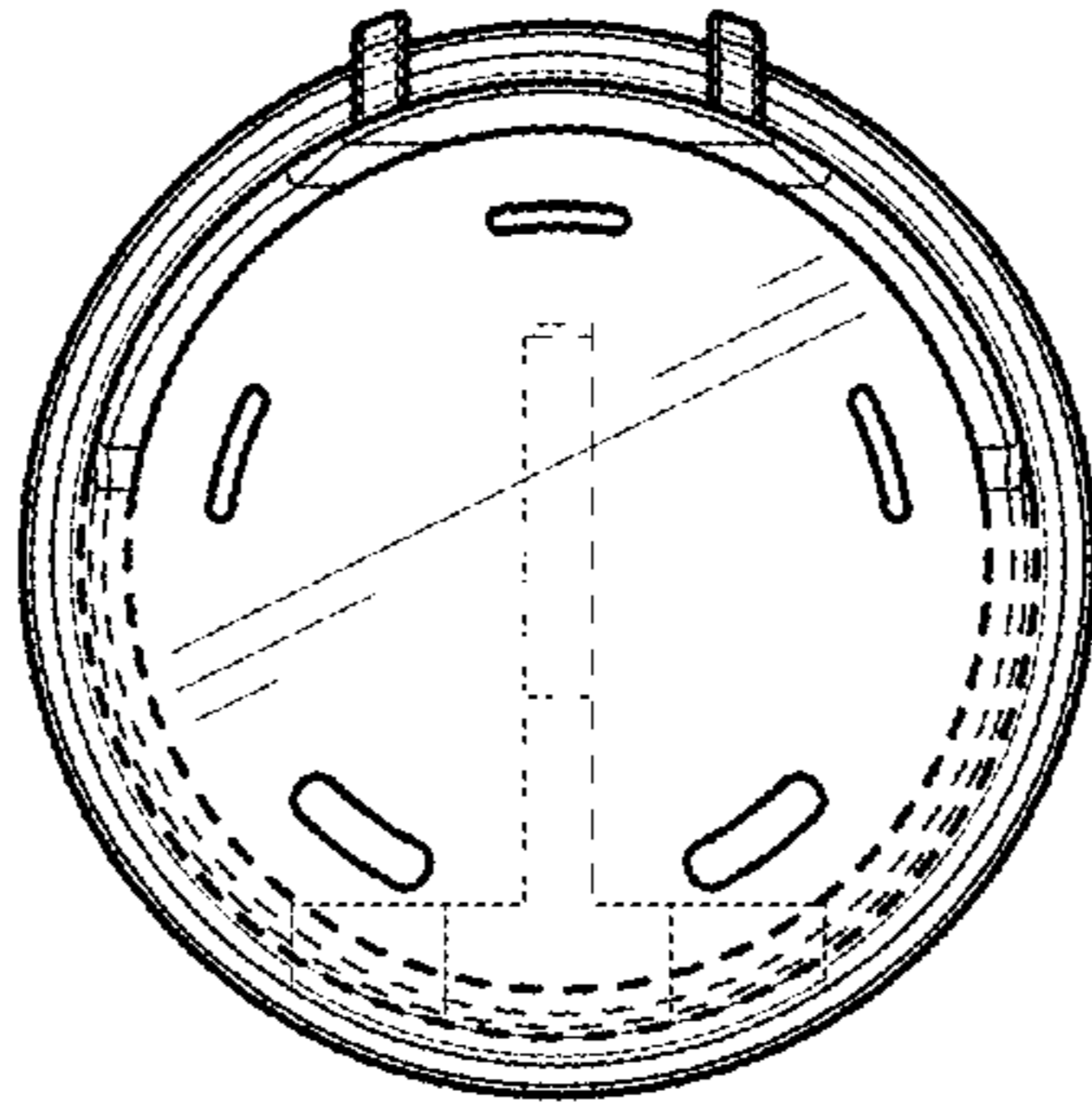

FIG. 41

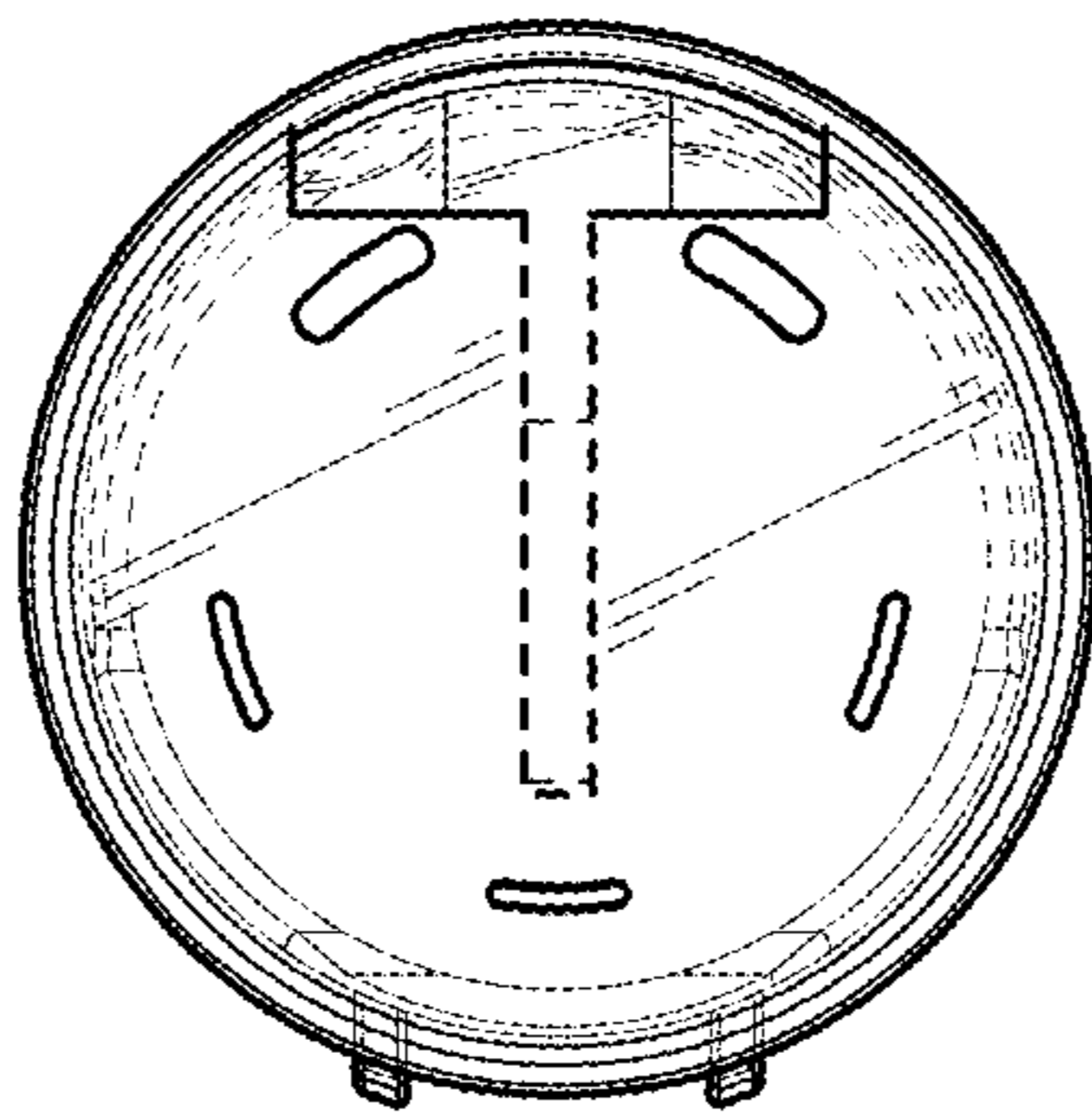

FIG. 42

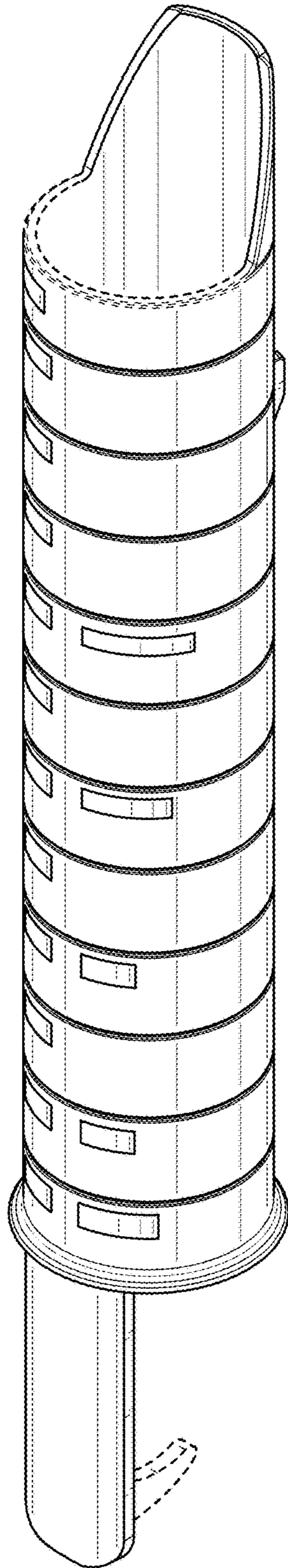

FIG. 43

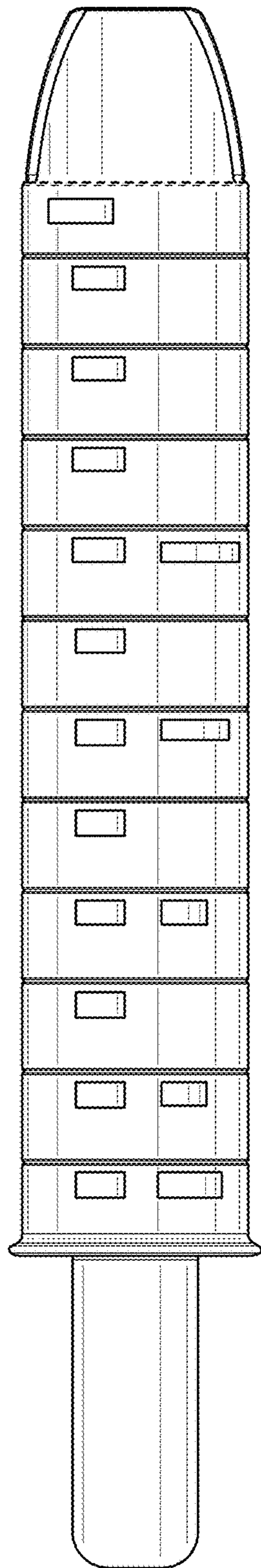

FIG. 44

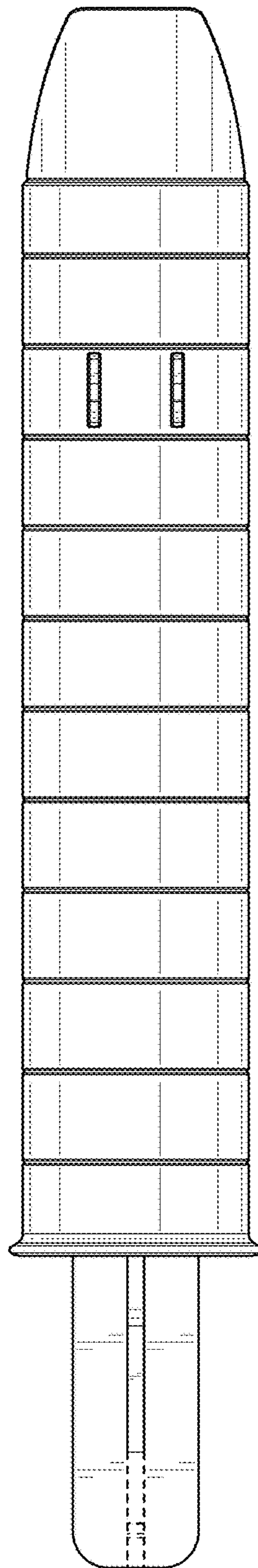

FIG. 45

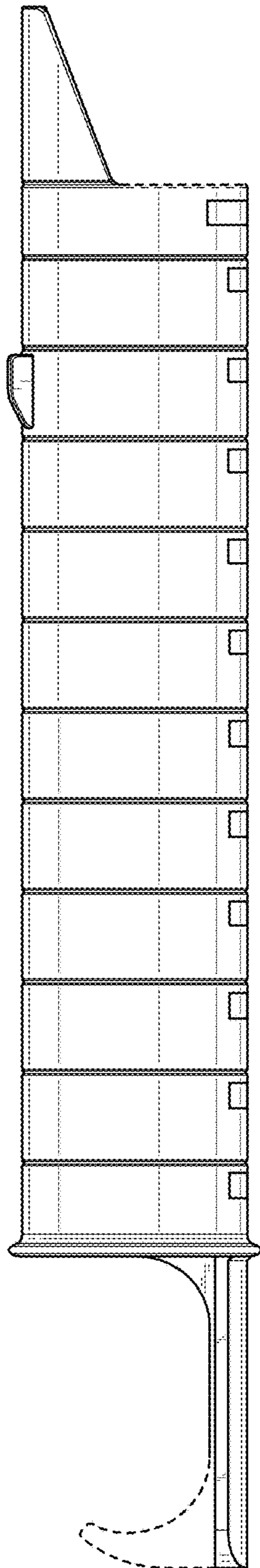

FIG. 46

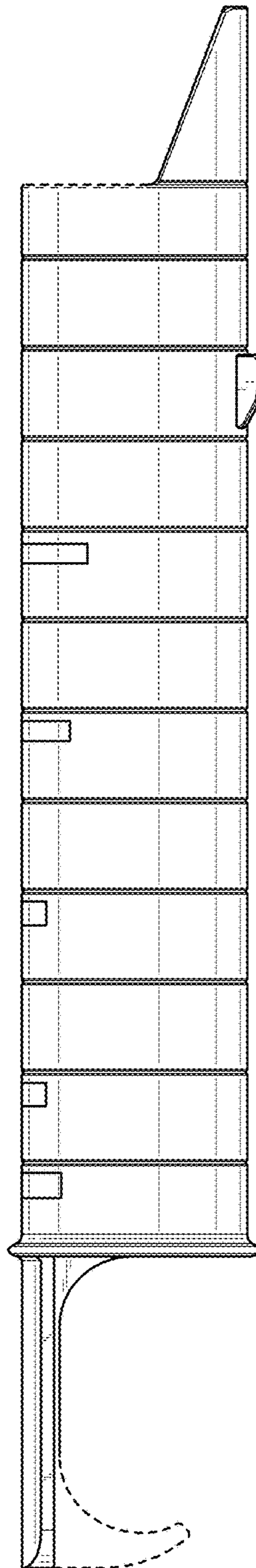

FIG. 47

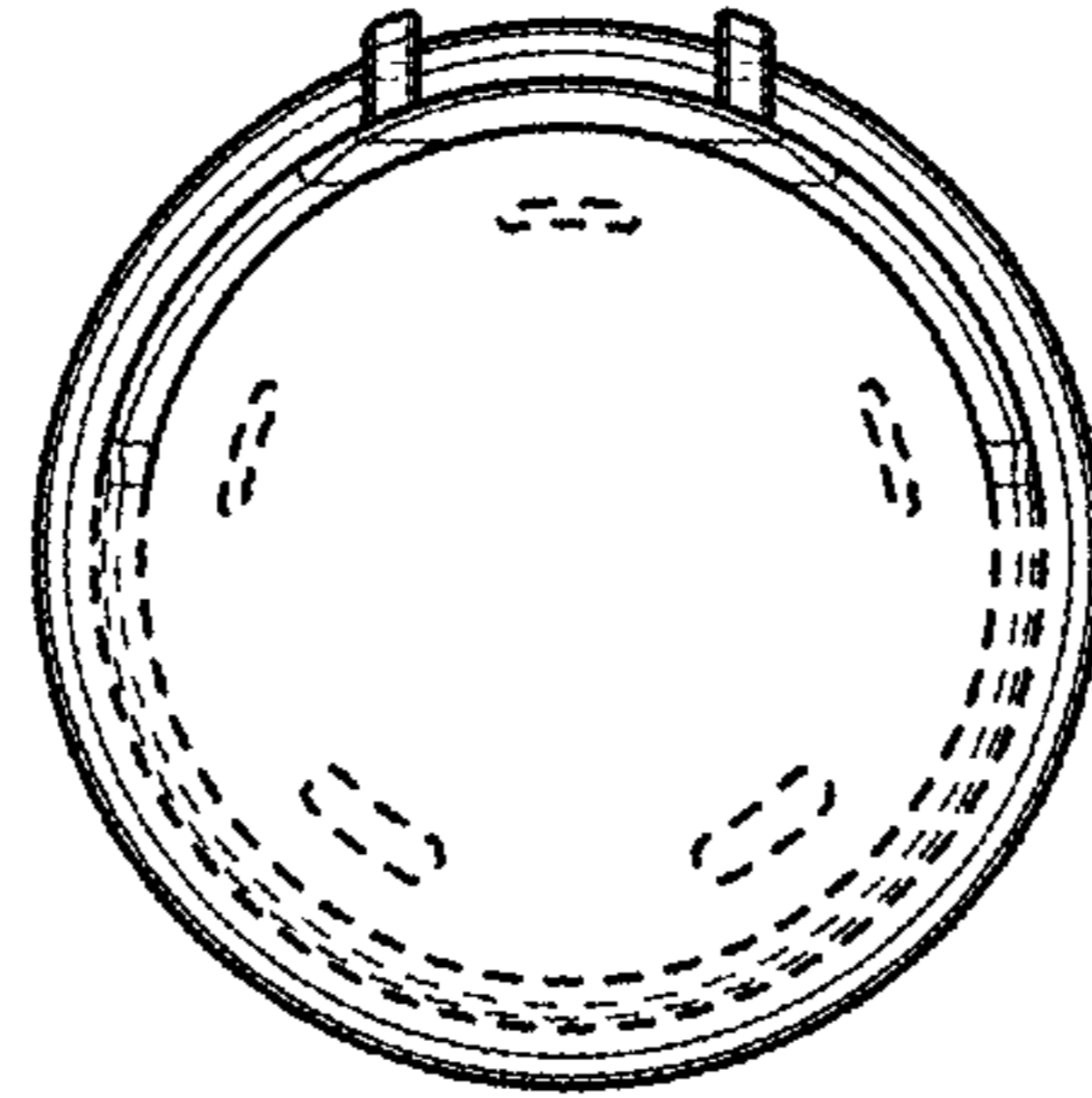

FIG. 48

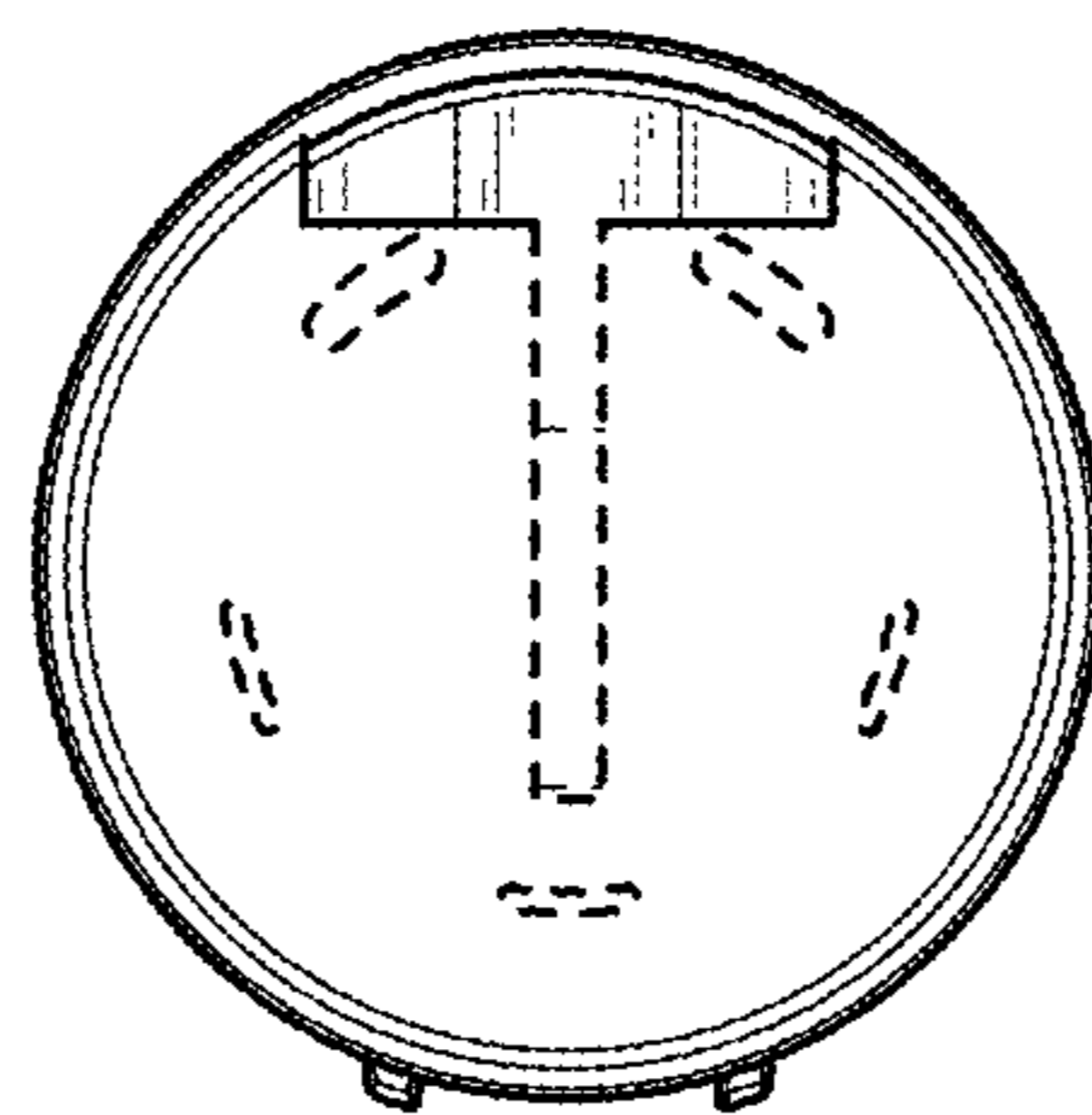

FIG. 49

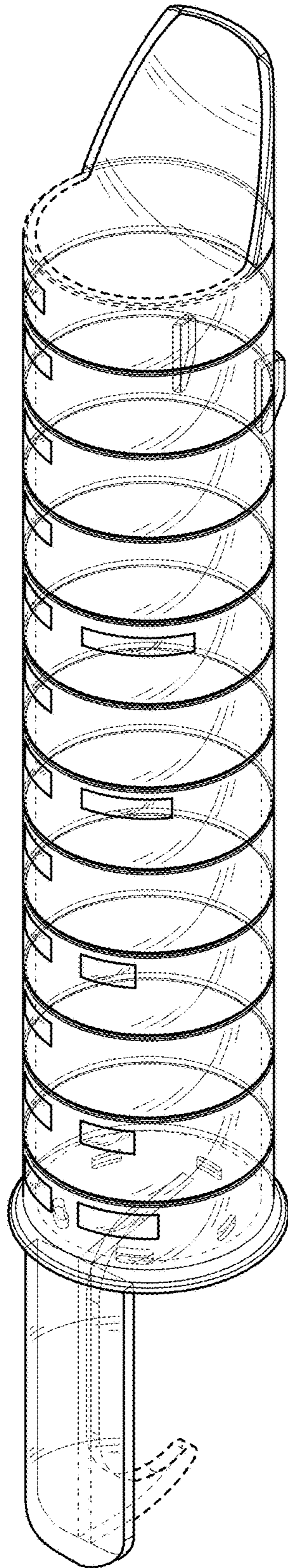

FIG. 50

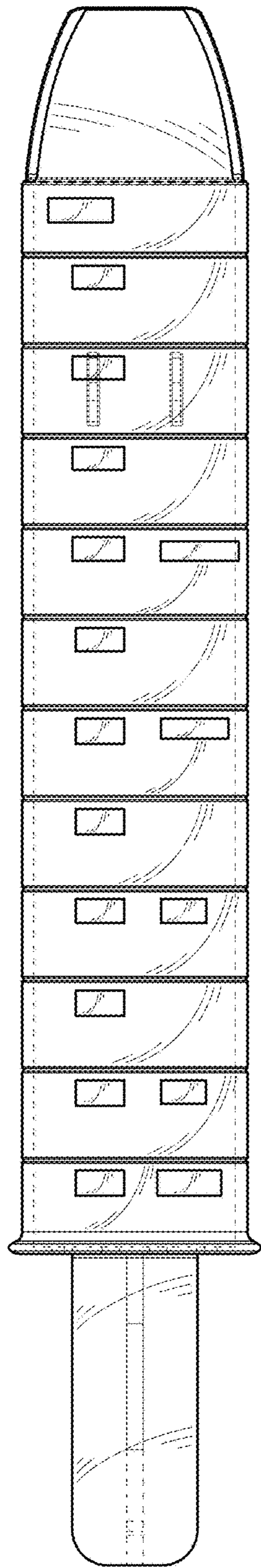

FIG. 51

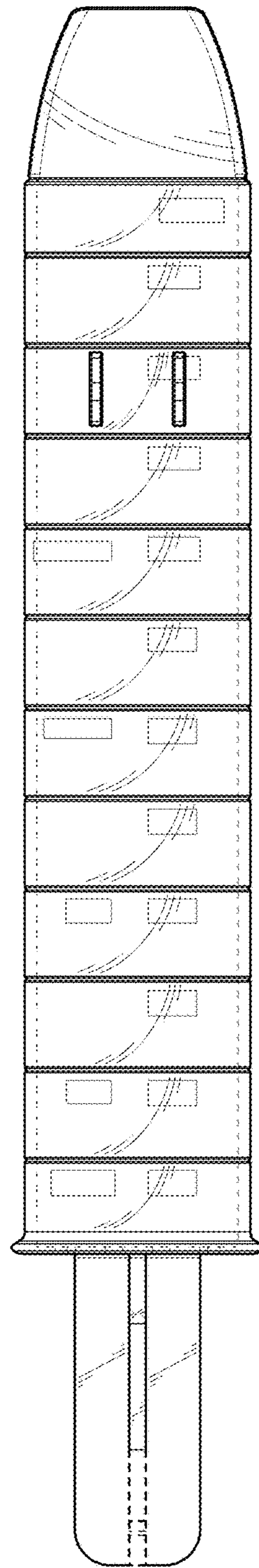

FIG. 52

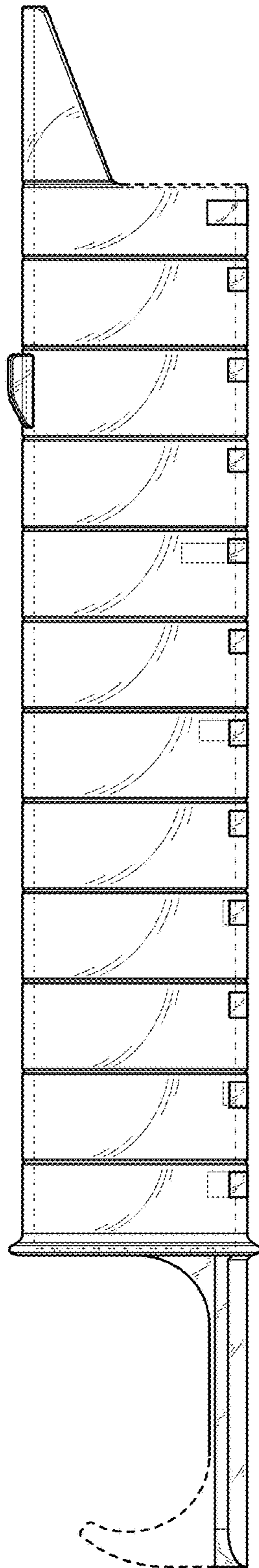

FIG. 53

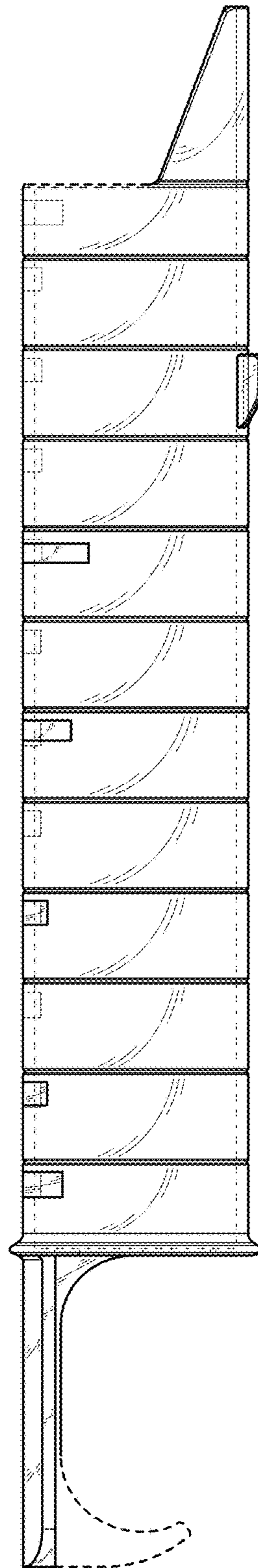

FIG. 54

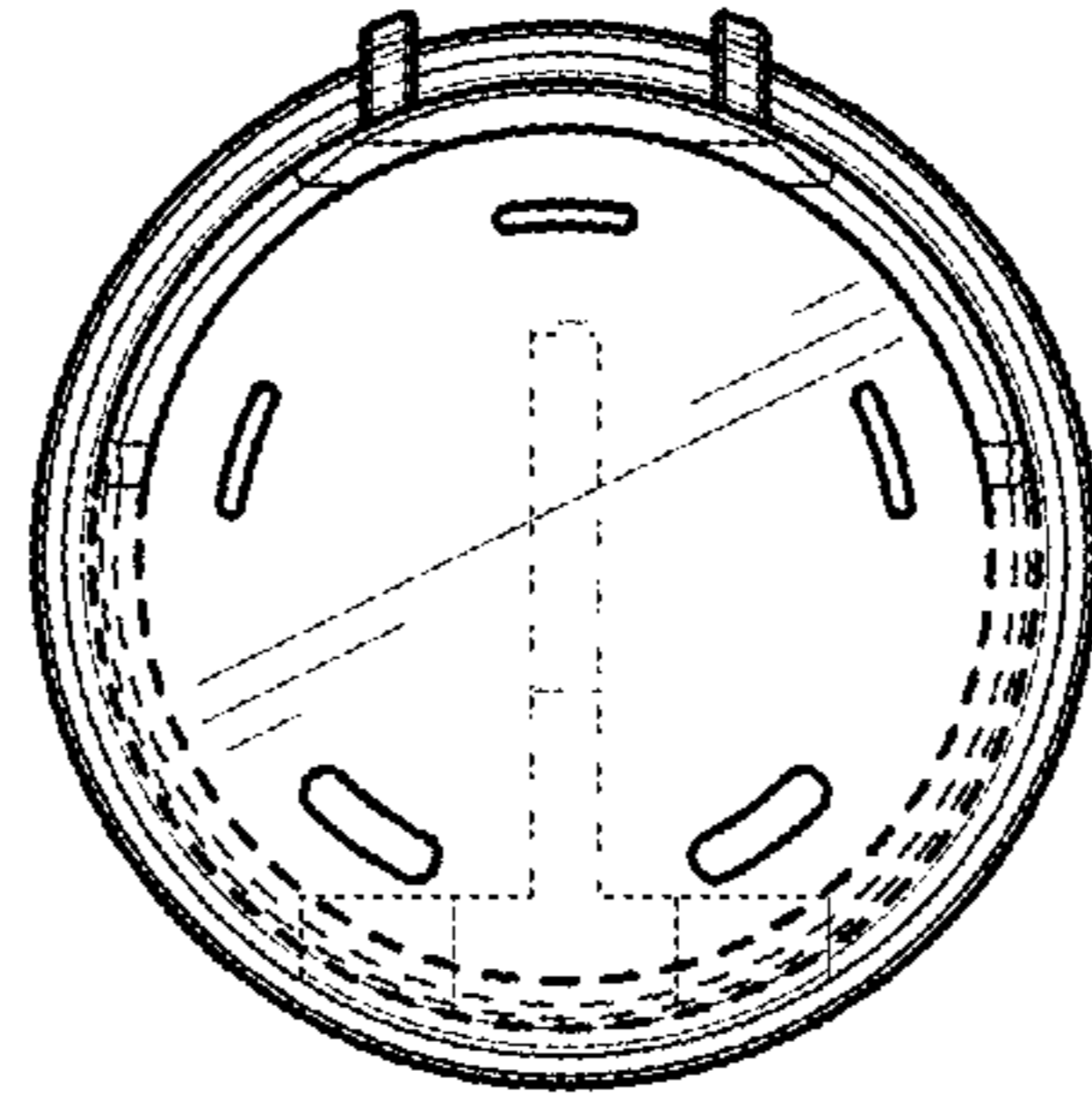

FIG. 55

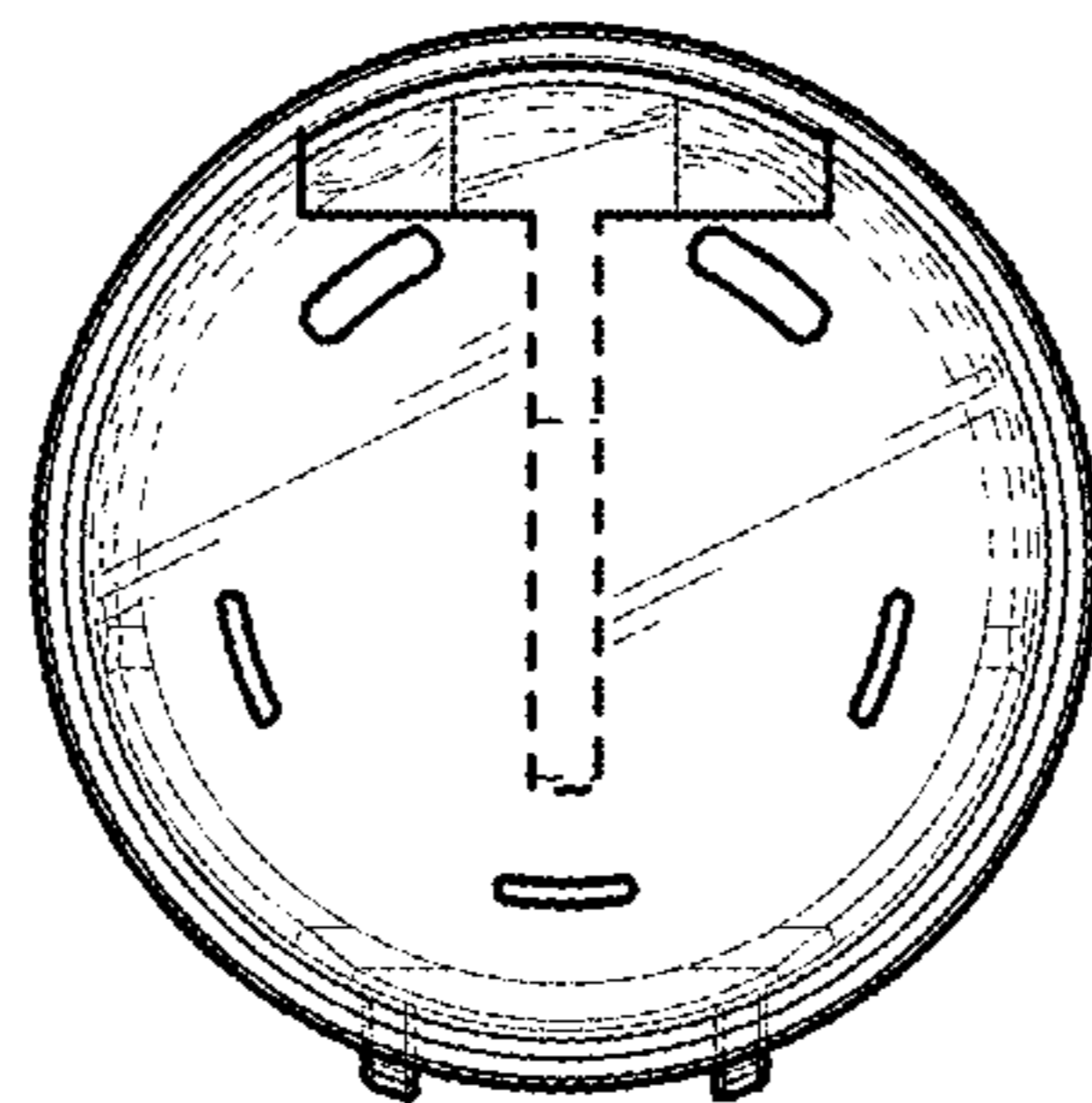

FIG. 56

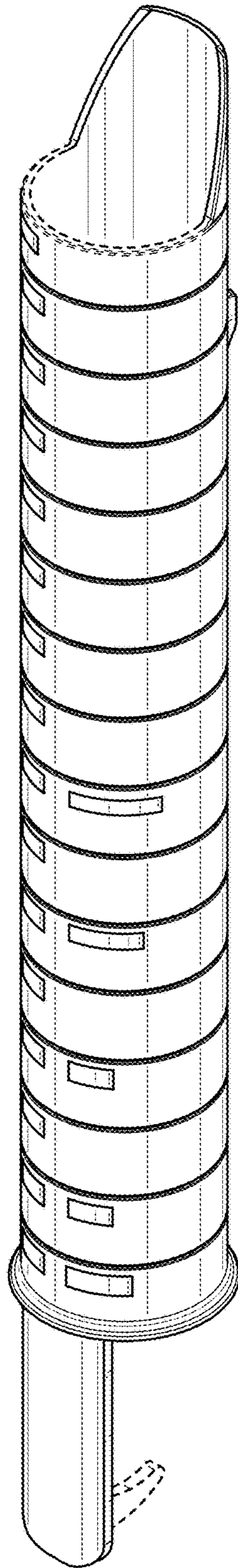

FIG. 57

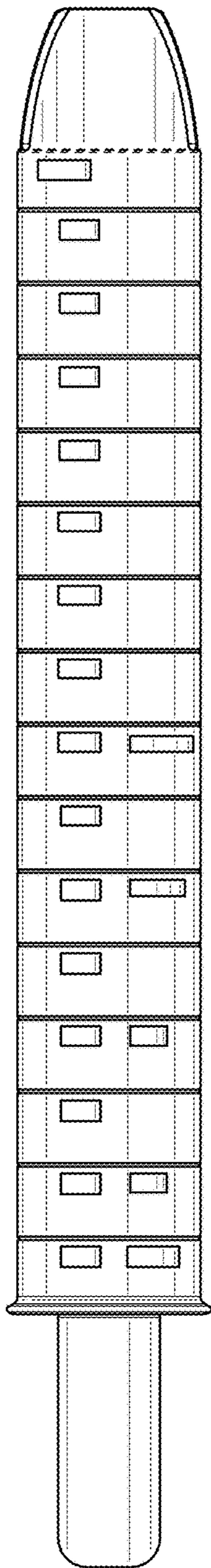

FIG. 58

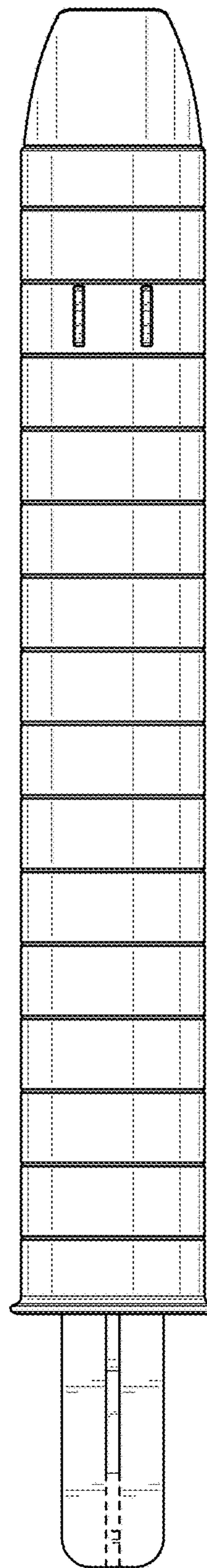

FIG. 59

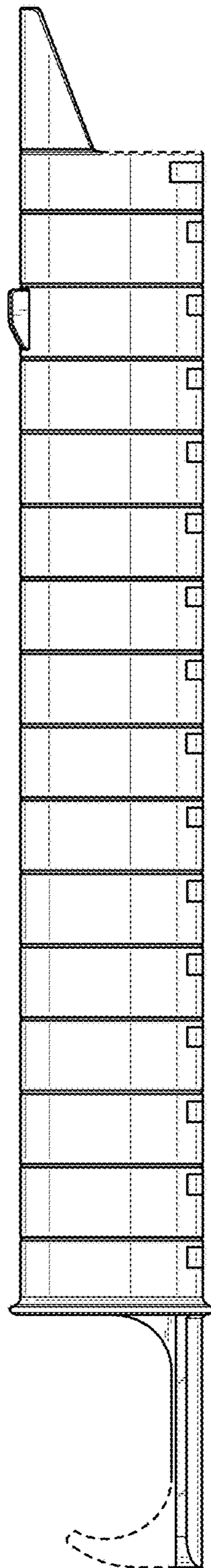

FIG. 60

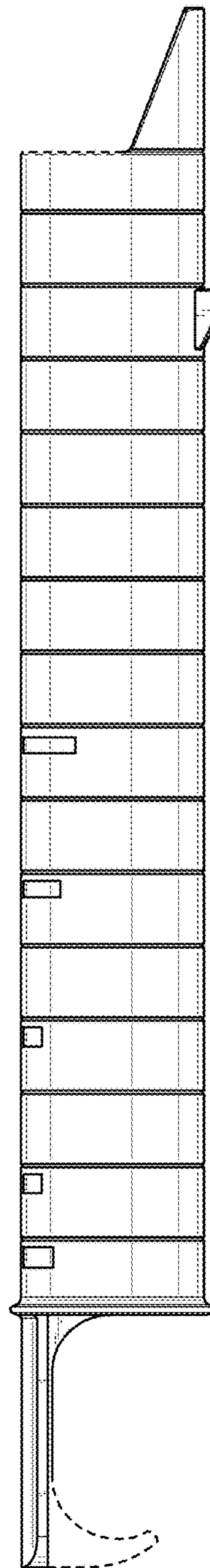

FIG. 61

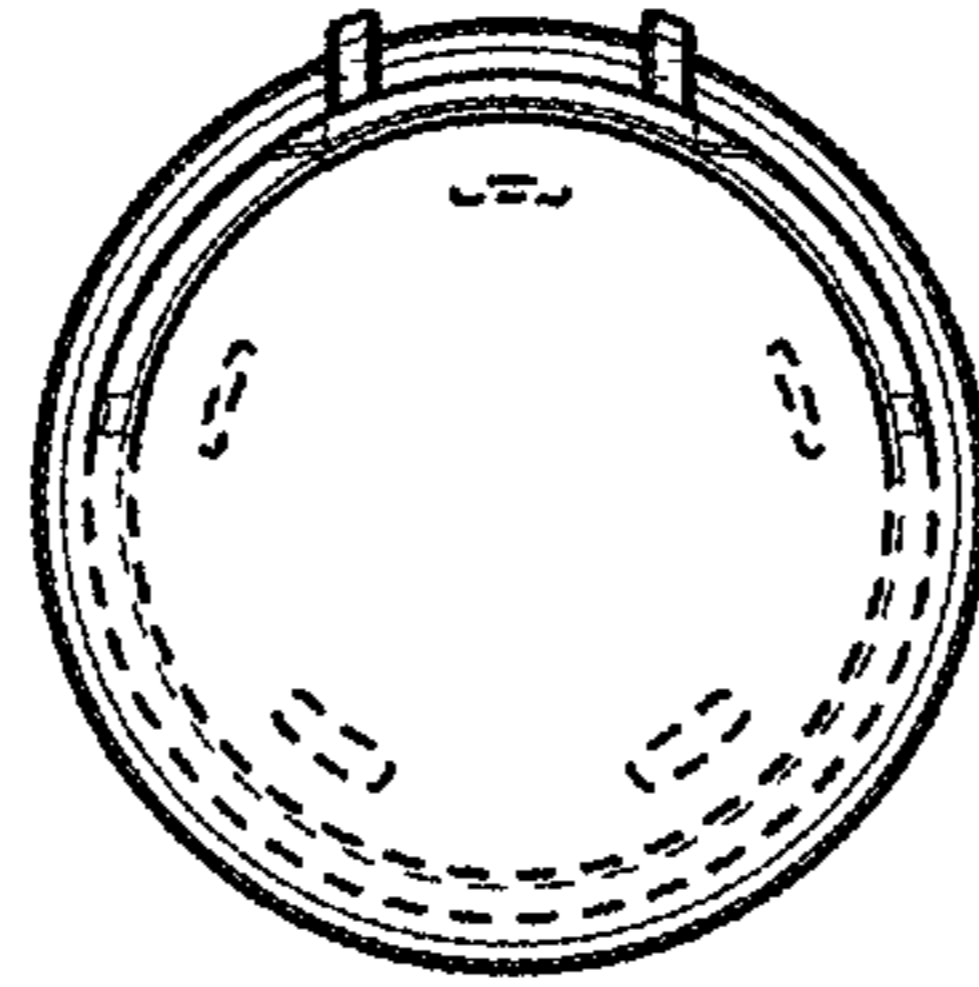

FIG. 62

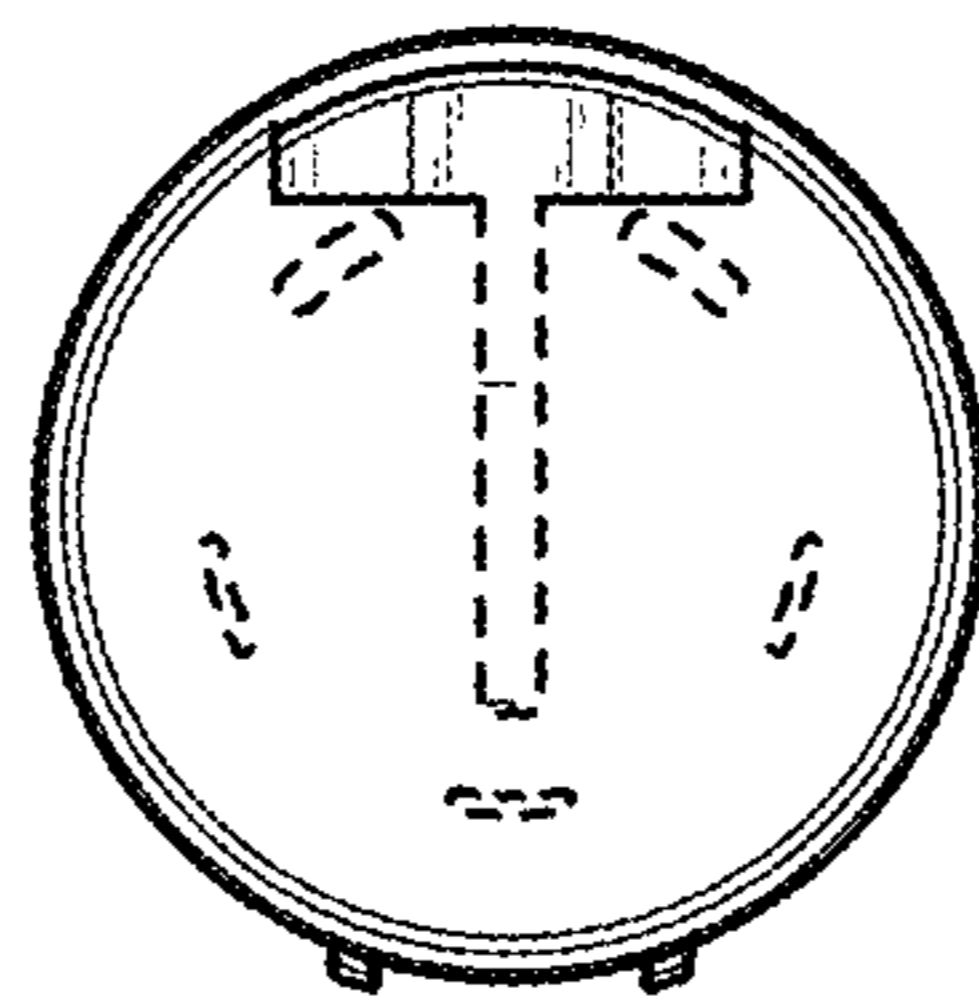

FIG. 63

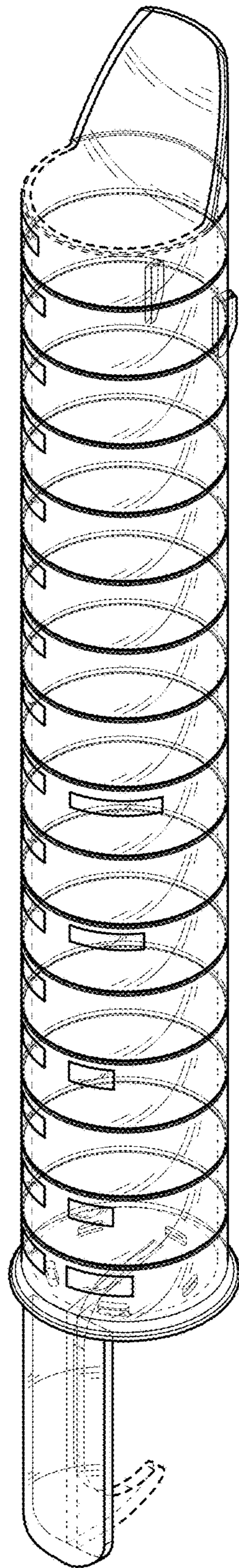

FIG. 64

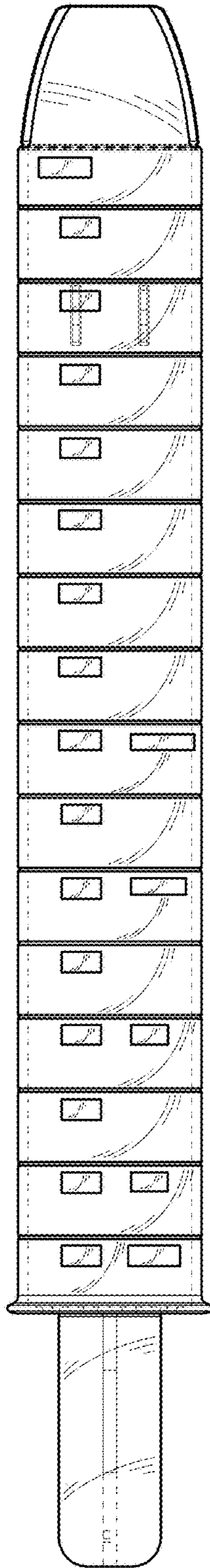

FIG. 65

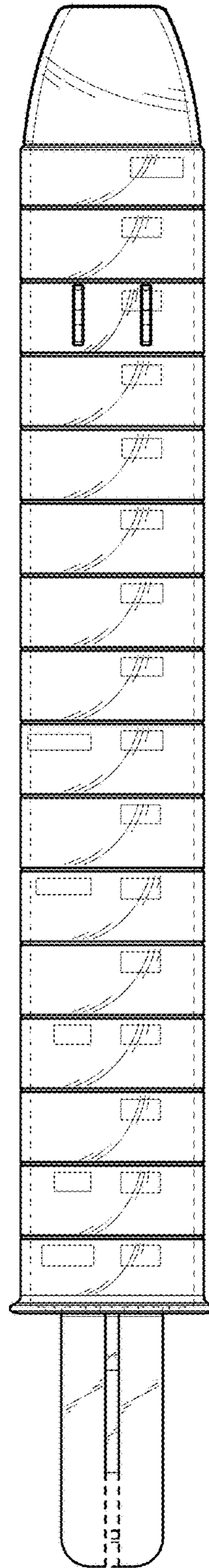

FIG. 66

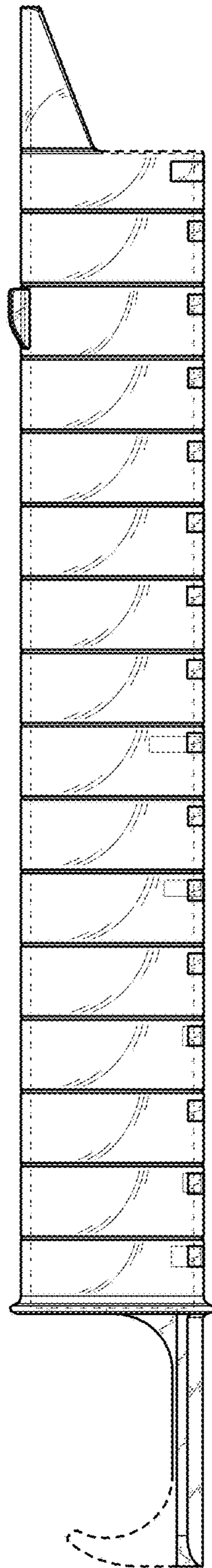

FIG. 67

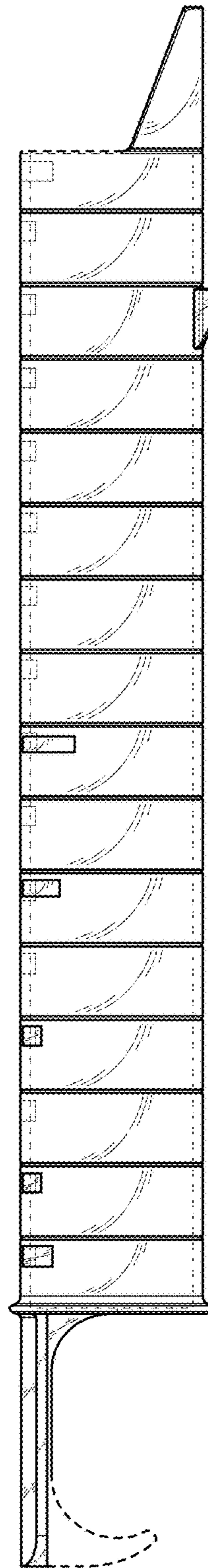

FIG. 68

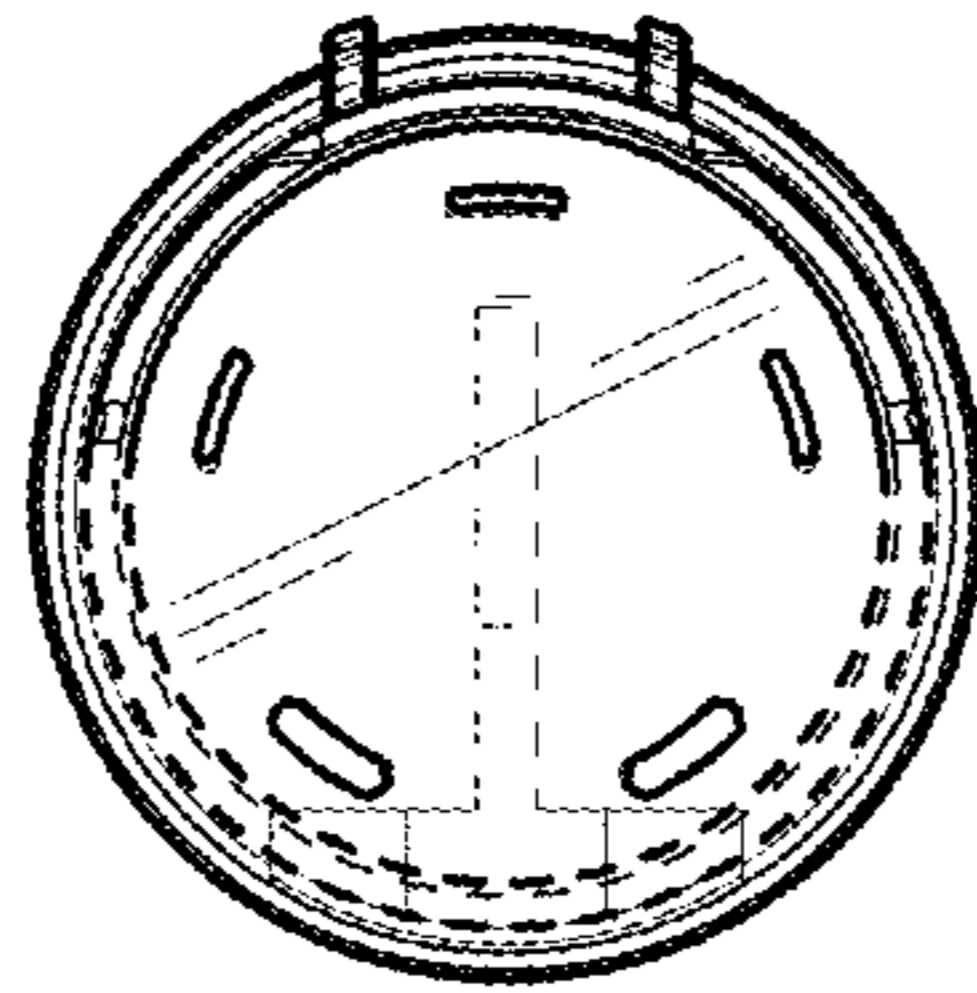

FIG. 69

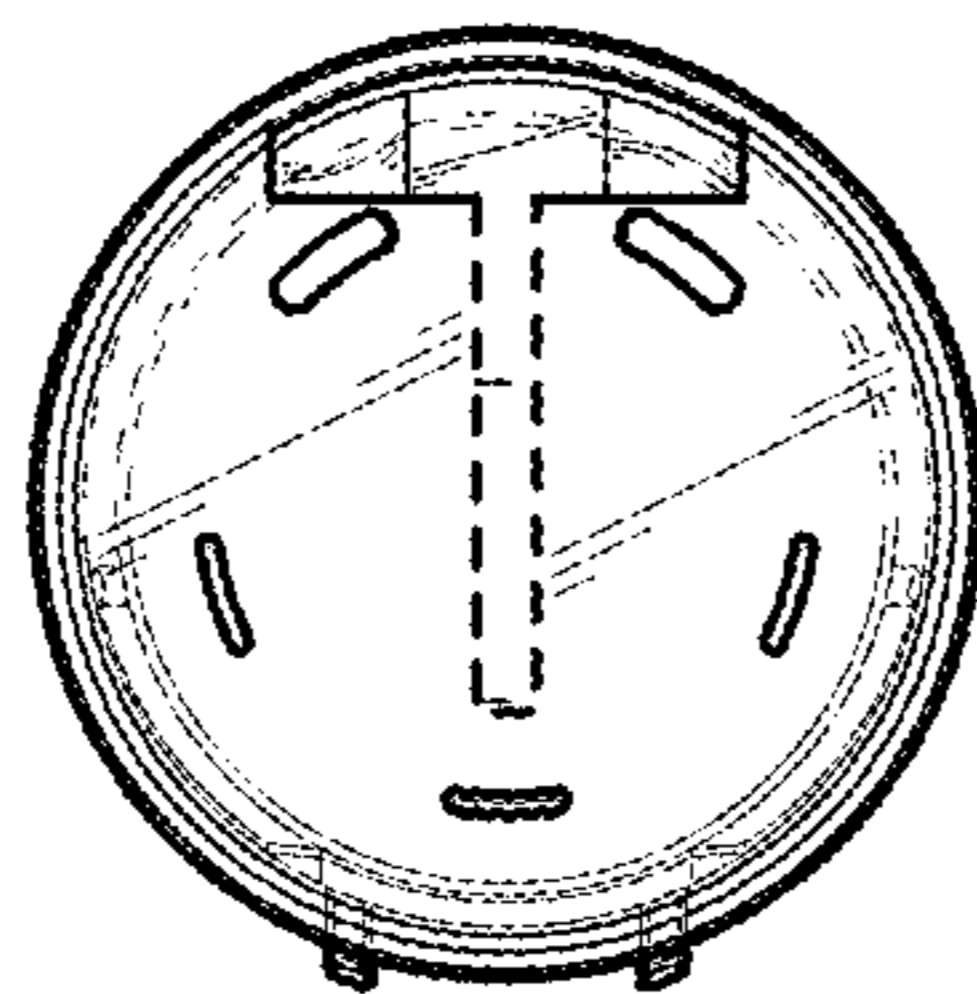

FIG. 70