



US00D835523S

(12) **United States Design Patent** (10) **Patent No.:** **US D835,523 S**  
**Pilot** (45) **Date of Patent:** **\*\* Dec. 11, 2018**

(54) **WATCH**  
(71) Applicant: **Montblanc-Simplo GmbH**, Hamburg (DE)  
(72) Inventor: **Eric Pillot**, Orchamps-Vennes (FR)  
(73) Assignee: **Montblanc-Simplo GmbH**, Hamburg (DE)  
(\*\*) Term: **15 Years**

D547,212 S \* 7/2007 Dias ..... D10/39  
D551,101 S \* 9/2007 Nataf ..... D10/38  
7,614,785 B2 \* 11/2009 Hiranuma ..... G04B 19/283  
368/294  
D649,890 S \* 12/2011 Favre ..... D10/38  
D712,754 S \* 9/2014 Loth ..... D10/32  
D723,408 S \* 3/2015 Ruffieux ..... D10/126  
D735,060 S \* 7/2015 Monachon ..... D10/32  
D736,656 S \* 8/2015 Ruffieux ..... D10/126  
D771,505 S \* 11/2016 Cerrato ..... D10/30  
D797,576 S \* 9/2017 Monachon ..... D10/30  
D801,832 S \* 11/2017 White ..... D10/30

(21) Appl. No.: **29/592,928**  
(22) Filed: **Feb. 3, 2017**  
(51) **LOC (11) Cl.** ..... **10-02**  
(52) **U.S. Cl.**  
USPC ..... **D10/39**  
(58) **Field of Classification Search**  
USPC ..... D10/1-2, 6-10, 14-15, 22, 30-39, 65,  
D10/70, 97-98, 122-126, 128; D14/344;  
D24/167, 186  
CPC ..... G04B 19/00; G04B 19/025; G04B 19/04;  
G04B 19/046; G04B 19/048; G04B  
19/06; G04B 19/08; G04B 19/085; G04B  
19/087; G04B 45/0069; G04B 45/0076;  
G04B 19/065; G04B 19/082; G04B  
19/10; G04B 19/103; G04B 19/106;  
G04B 19/12; G04B 19/16; G04B 19/163;  
G04B 19/166; G04B 19/18; G04B 19/22;  
G04B 19/223; G04B 19/225; G04B  
19/226; G04B 19/228; G04B 27/00;  
G04B 27/06  
See application file for complete search history.

**OTHER PUBLICATIONS**

Montblanc TimeWalker Date Automatic ref. 115079 | posted at forums.timezone.com Jan. 2016 © 2018 Bourne in Time Inc. [online][stie visited Mar. 9, 2018]. Available from Internet: <http://forums.timezone.com/index.php?t=tree&goto=7186777&rid=12189#msg\_7186777> (Year: 2016).\*

\* cited by examiner

*Primary Examiner* — Shannon W Morgan  
*Assistant Examiner* — Katherine Glennon  
(74) *Attorney, Agent, or Firm* — Taft Stettinius & Hollister LLP

(57) **CLAIM**

The ornamental design for a watch, as shown and described.

**DESCRIPTION**

FIG. 1 is a front elevational view of a watch showing my new design;  
FIG. 2 is a back elevational view thereof;  
FIG. 3 is a right side elevational view thereof;  
FIG. 4 is a left side elevational view thereof;  
FIG. 5 is a bottom plan view thereof;  
FIG. 6 is a top plan view thereof; and,  
FIG. 7 is a front, right side perspective view thereof.

**1 Claim, 7 Drawing Sheets**

(56) **References Cited**

**U.S. PATENT DOCUMENTS**

D357,636 S \* 4/1995 Riley ..... D10/30  
D449,005 S \* 10/2001 Ando ..... D10/30  
D509,150 S \* 9/2005 Bodino ..... D10/32  
D536,995 S \* 2/2007 Oshita ..... D10/31

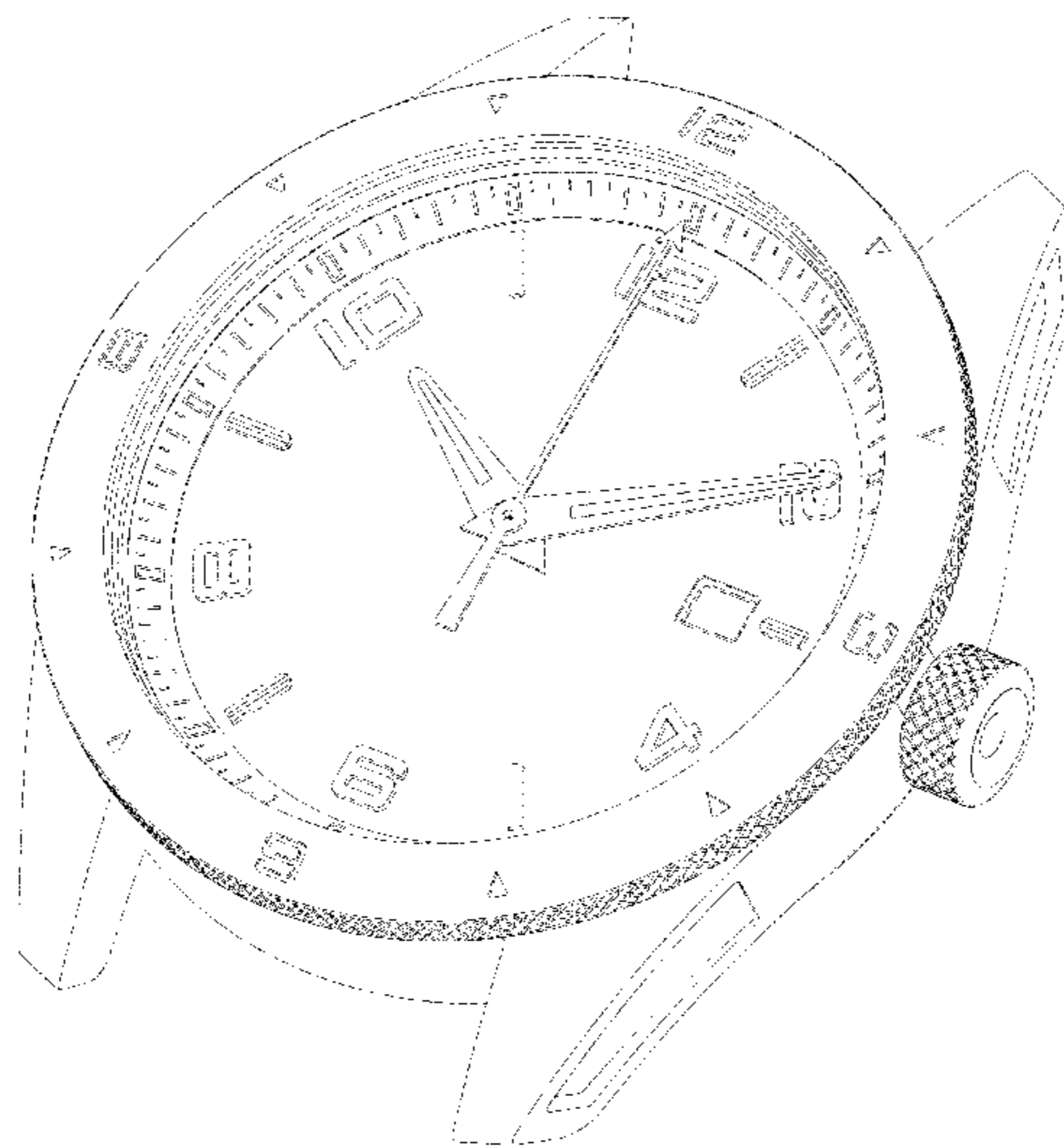

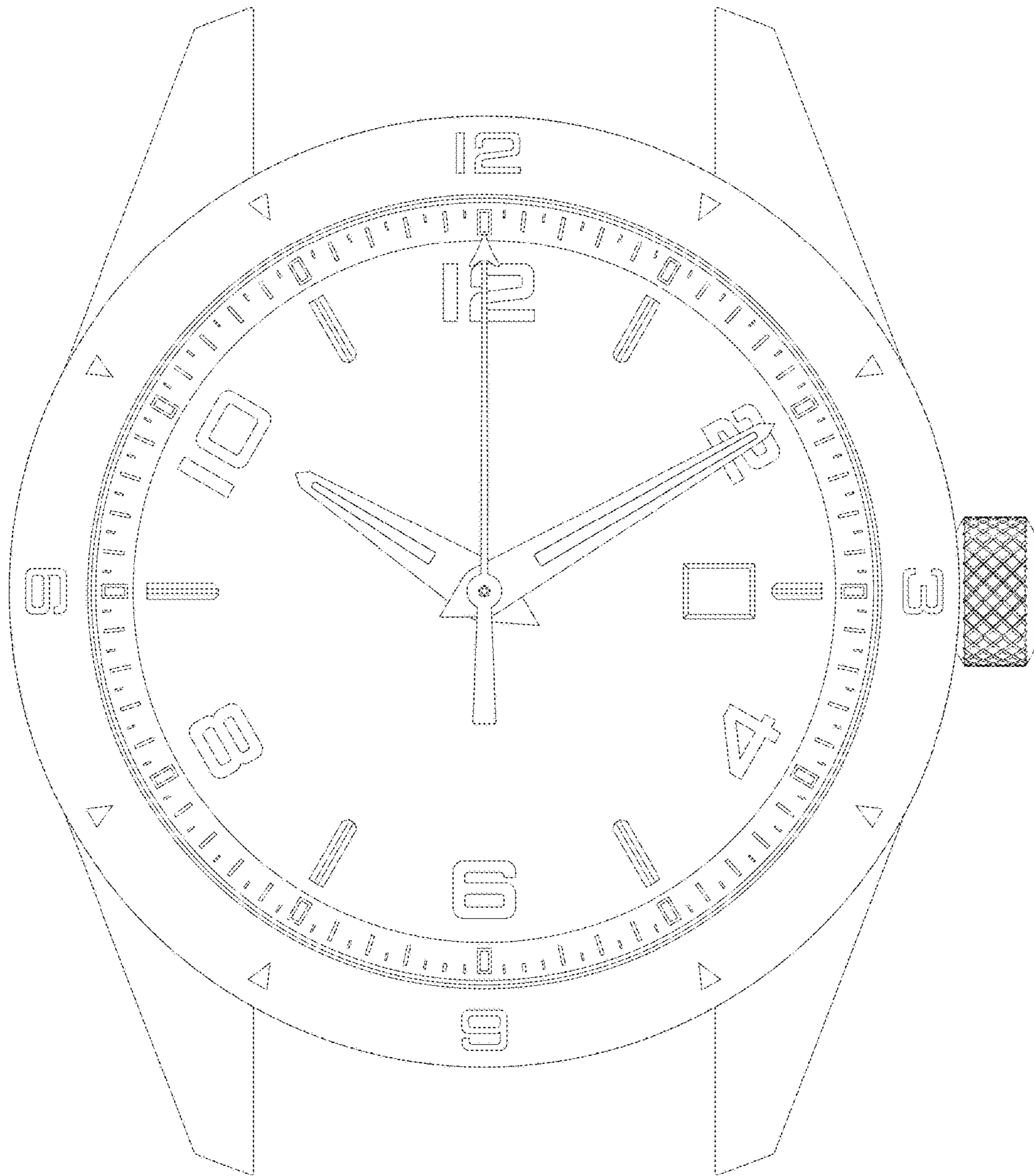

Fig. 1

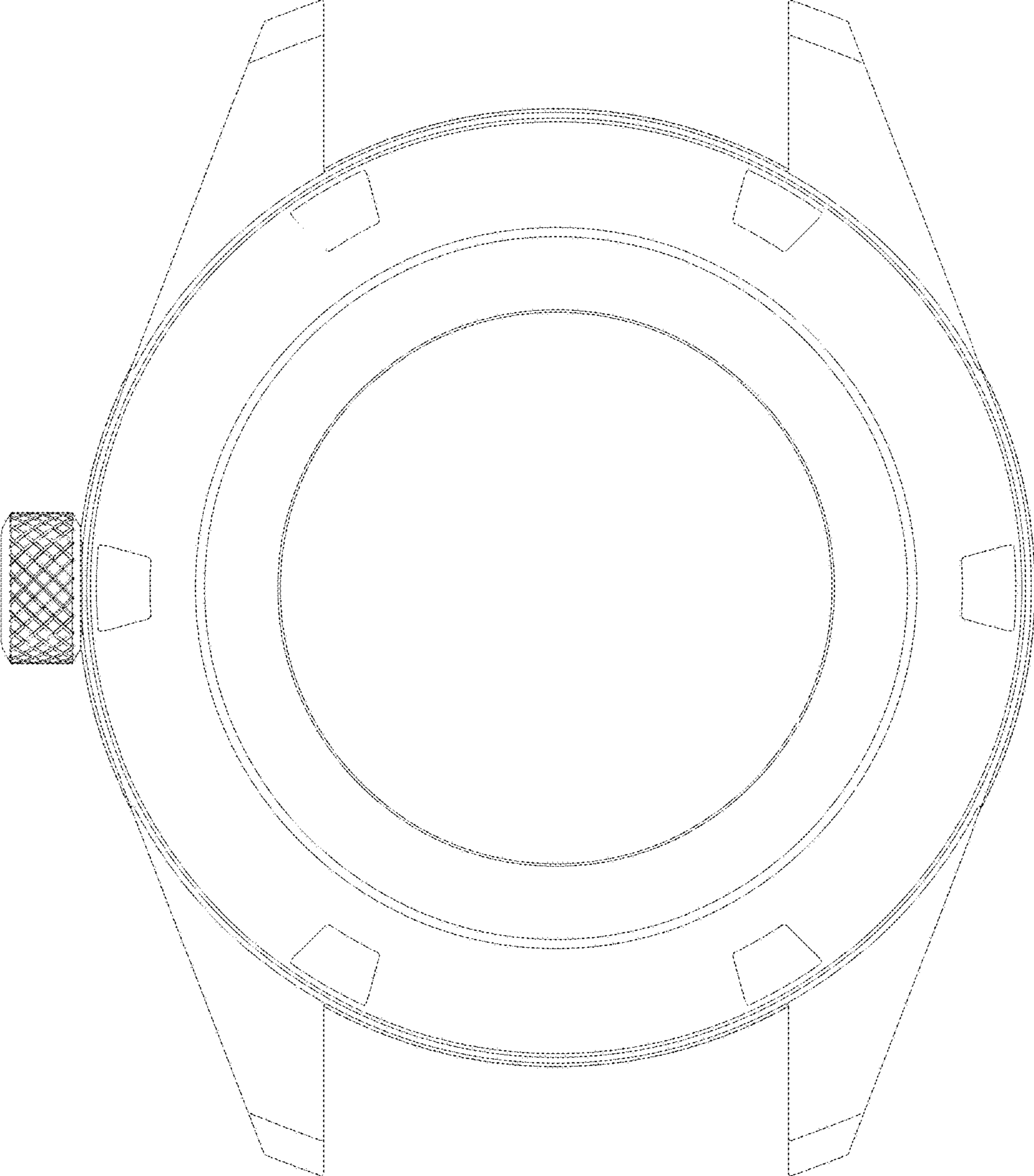

Fig. 2

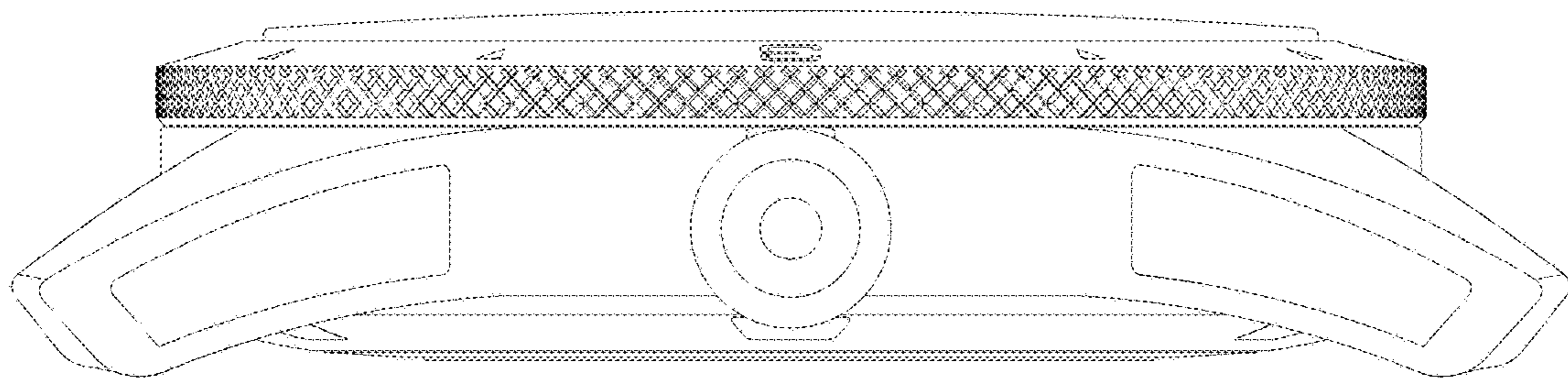

Fig. 3



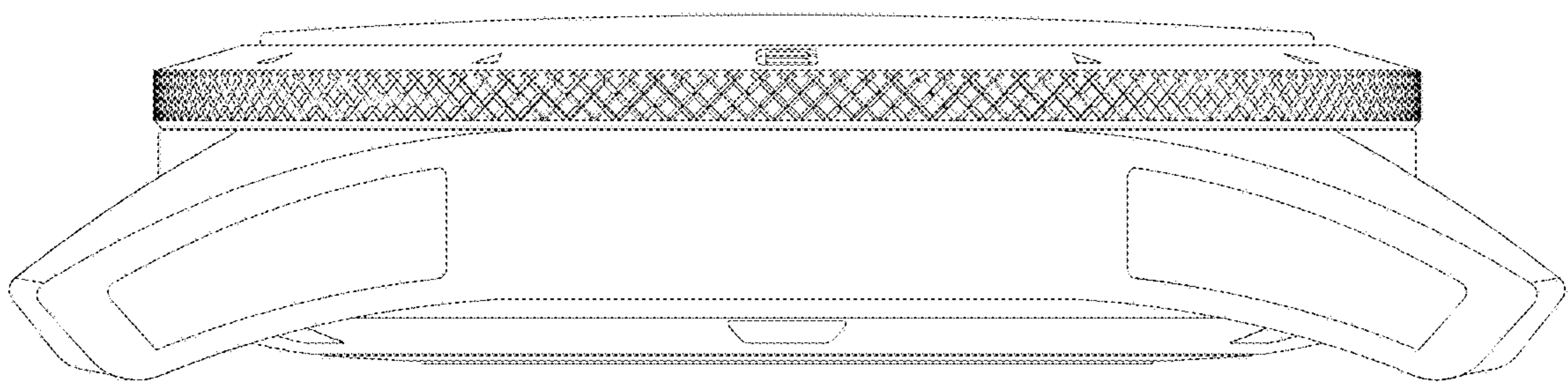

Fig. 4

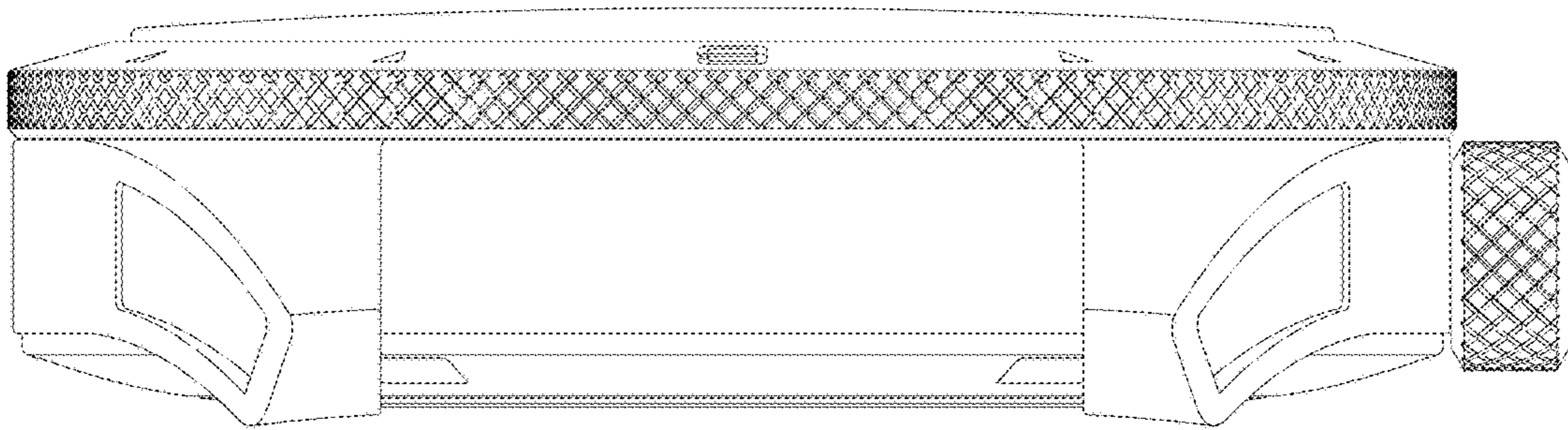

Fig. 5

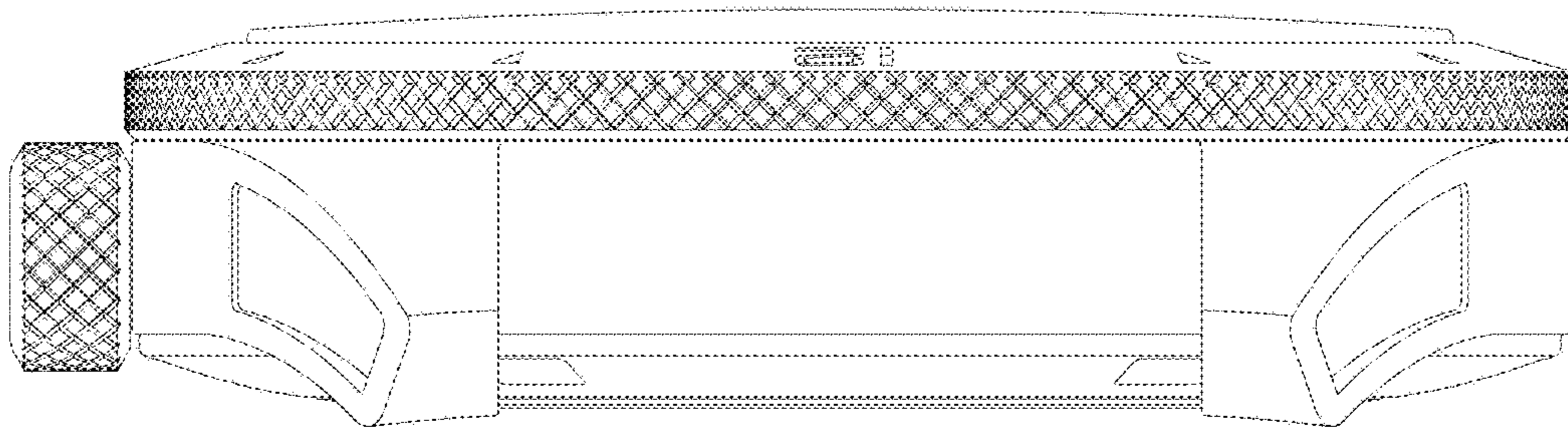

Fig. 6

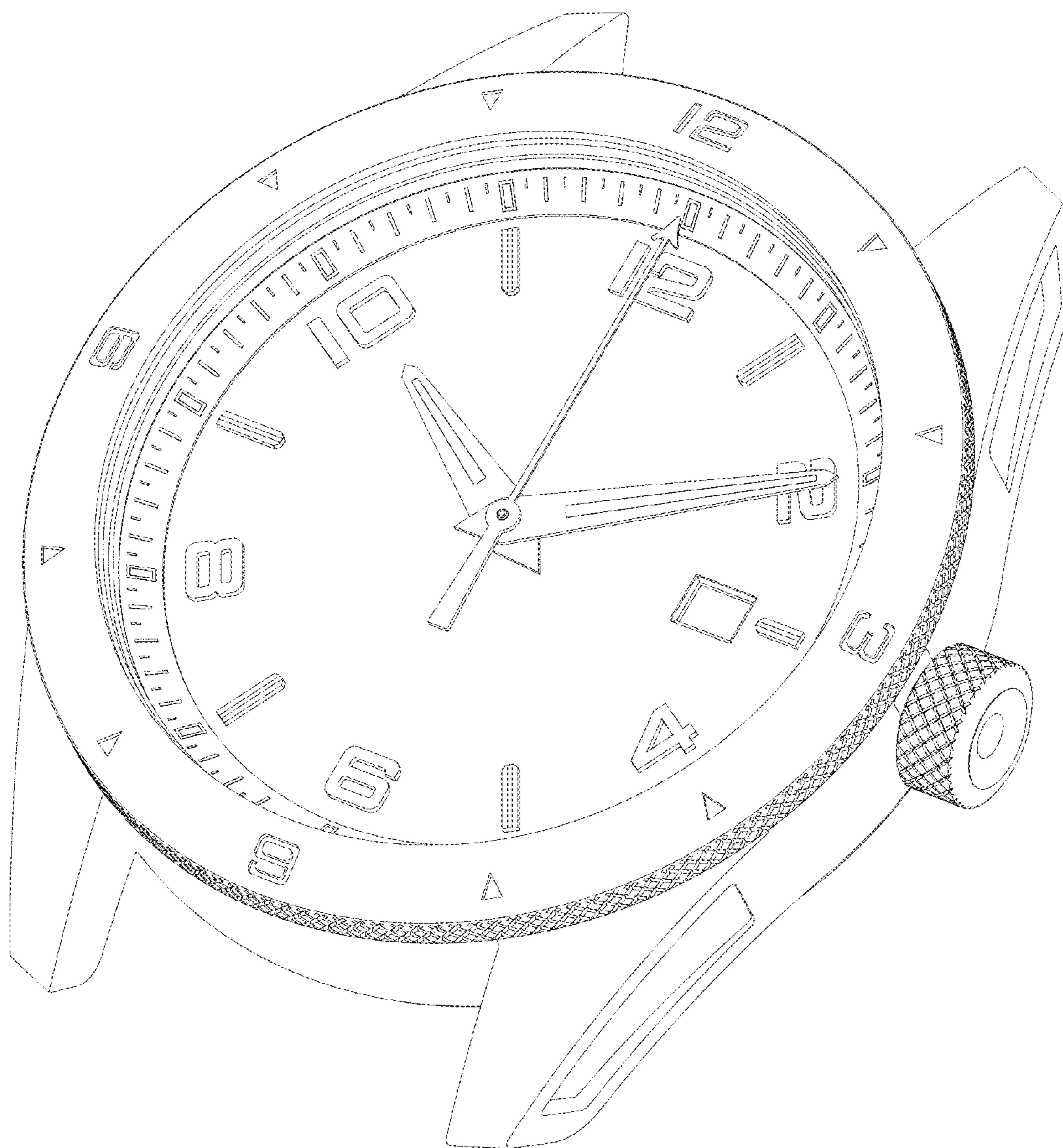

Fig. 7