



US00D835493S

(12) **United States Design Patent** (10) **Patent No.:** **US D835,493 S**
Chun (45) **Date of Patent:** **** Dec. 11, 2018**

(54) **ADJUSTABLE BALL STAND MOUNT**

(71) Applicant: **James Chun**, Bellevue, WA (US)

(72) Inventor: **James Chun**, Bellevue, WA (US)

(**) Term: **15 Years**

(21) Appl. No.: **29/568,423**

(22) Filed: **Jun. 17, 2016**

(51) **LOC (11) Cl.** **08-05**

(52) **U.S. Cl.**
USPC **D8/354**

(58) **Field of Classification Search**
USPC D8/349, 354, 382, 388, 499; D14/432,
D14/433, 217, 251, 253, 256
CPC ... F16C 11/06; F16C 11/0604; F16C 11/0619;
F16C 11/0685; Y10T 403/32631
See application file for complete search history.

(56) **References Cited**

U.S. PATENT DOCUMENTS

| | | | | |
|----------------|---------|-----------|-------|-----------------------|
| D376,805 S * | 12/1996 | Johansson | | D14/253 |
| D638,008 S * | 5/2011 | Richter | | D14/253 |
| D657,783 S * | 4/2012 | Mo | | D14/251 |
| D677,709 S * | 3/2013 | Skeoch | | D16/242 |
| 8,454,178 B2 * | 6/2013 | Carnevali | | G02B 7/182 248/481 |
| D744,817 S * | 12/2015 | Hyakutake | | D8/382 |
| 9,728,170 B2 * | 8/2017 | Slaton | | G10G 7/00 |
| D799,469 S * | 10/2017 | Esses | | D14/253 |

| | | | | |
|-------------------|--------|-----------|-------|---------------------------|
| 2011/0139947 A1 * | 6/2011 | Lee | | F16C 11/0619 248/122.1 |
| 2012/0049019 A1 * | 3/2012 | Chen | | F16B 2/185 248/206.2 |
| 2014/0034794 A1 * | 2/2014 | Carnevali | | F16M 11/041 248/205.3 |
| 2016/0229462 A1 * | 8/2016 | Nachbar | | B60C 7/001 |

* cited by examiner

Primary Examiner — Sandra S Snapp

Assistant Examiner — Ieisha N Price

(74) *Attorney, Agent, or Firm* — Dean Craine

(57) **CLAIM**

The ornamental design for an adjustable ball stand mount, as shown and described.

DESCRIPTION

FIG. 1 is a top perspective view of an adjustable ball stand mount.

FIG. 2 is a bottom perspective view of the invention.

FIG. 3 is a front elevational view of the invention.

FIG. 4 is a right side elevation view of the invention.

FIG. 5 is a rear elevational view of the invention.

FIG. 6 is a left side view of the invention.

FIG. 7 is a top plan view of the invention; and,

FIG. 8 is a bottom plan view of the invention.

The broken lines in the drawings illustrate portions of the adjustable ball stand mount and form no part of the claimed design.

1 Claim, 7 Drawing Sheets

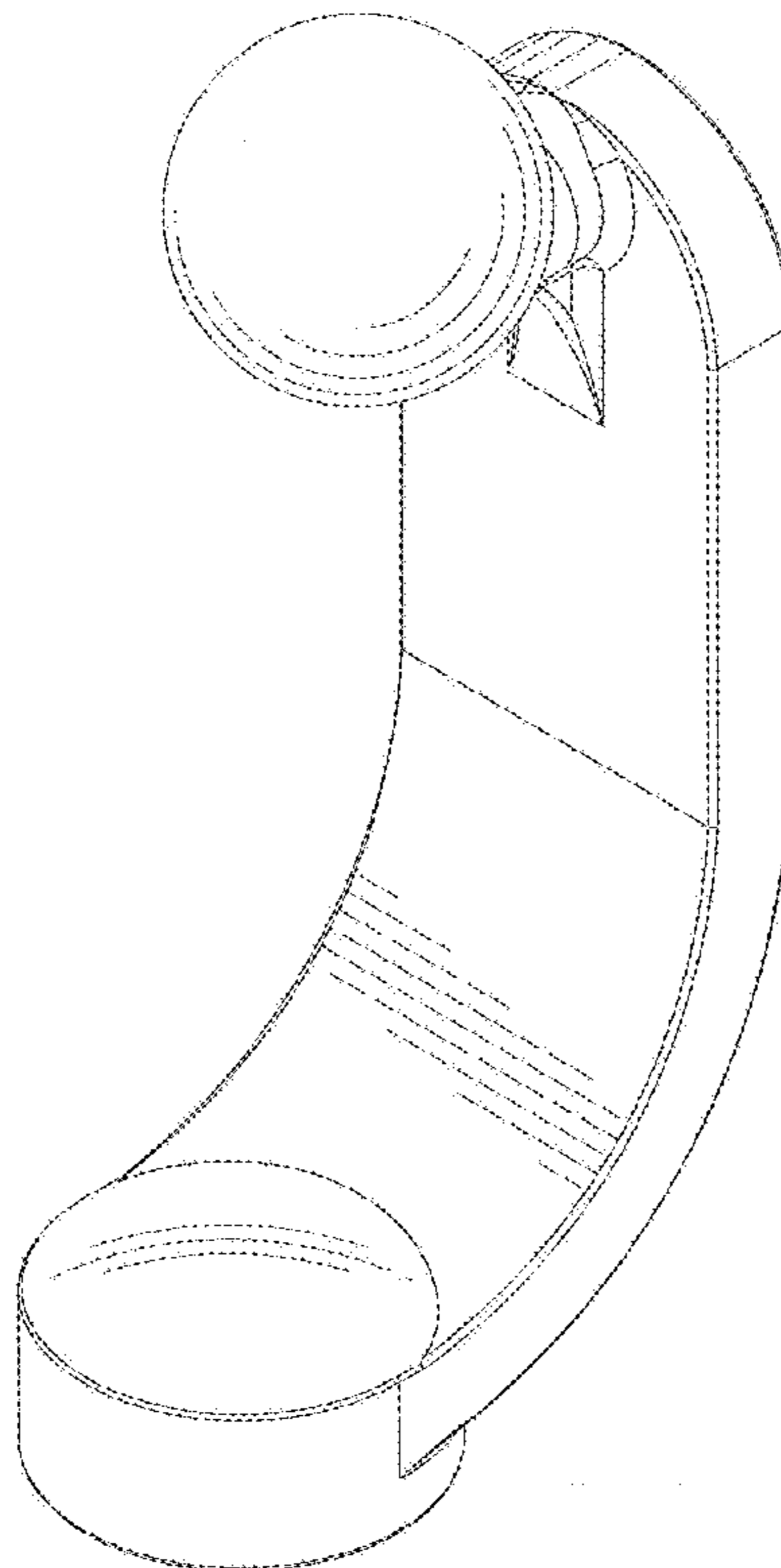

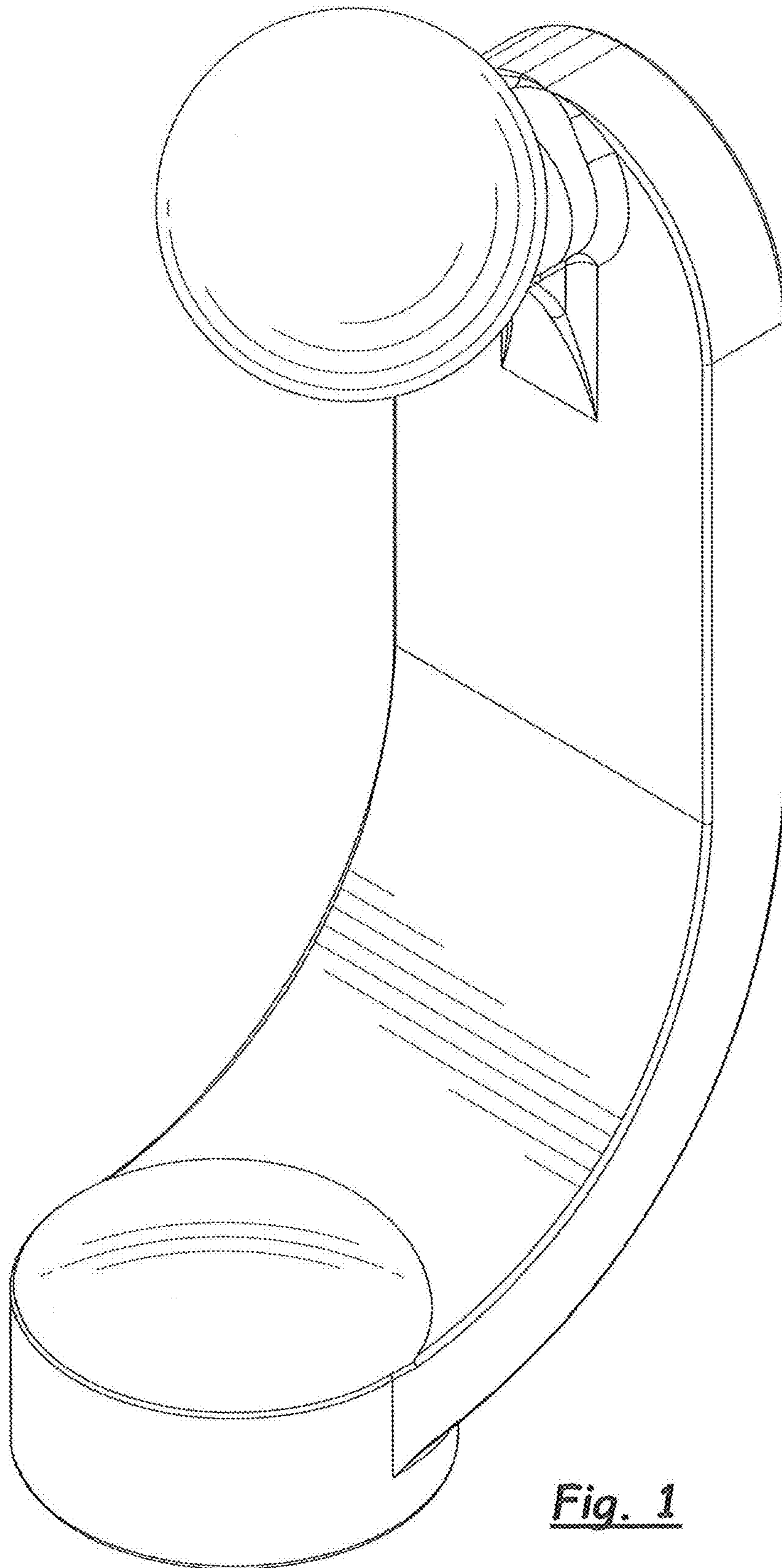

Fig. 1

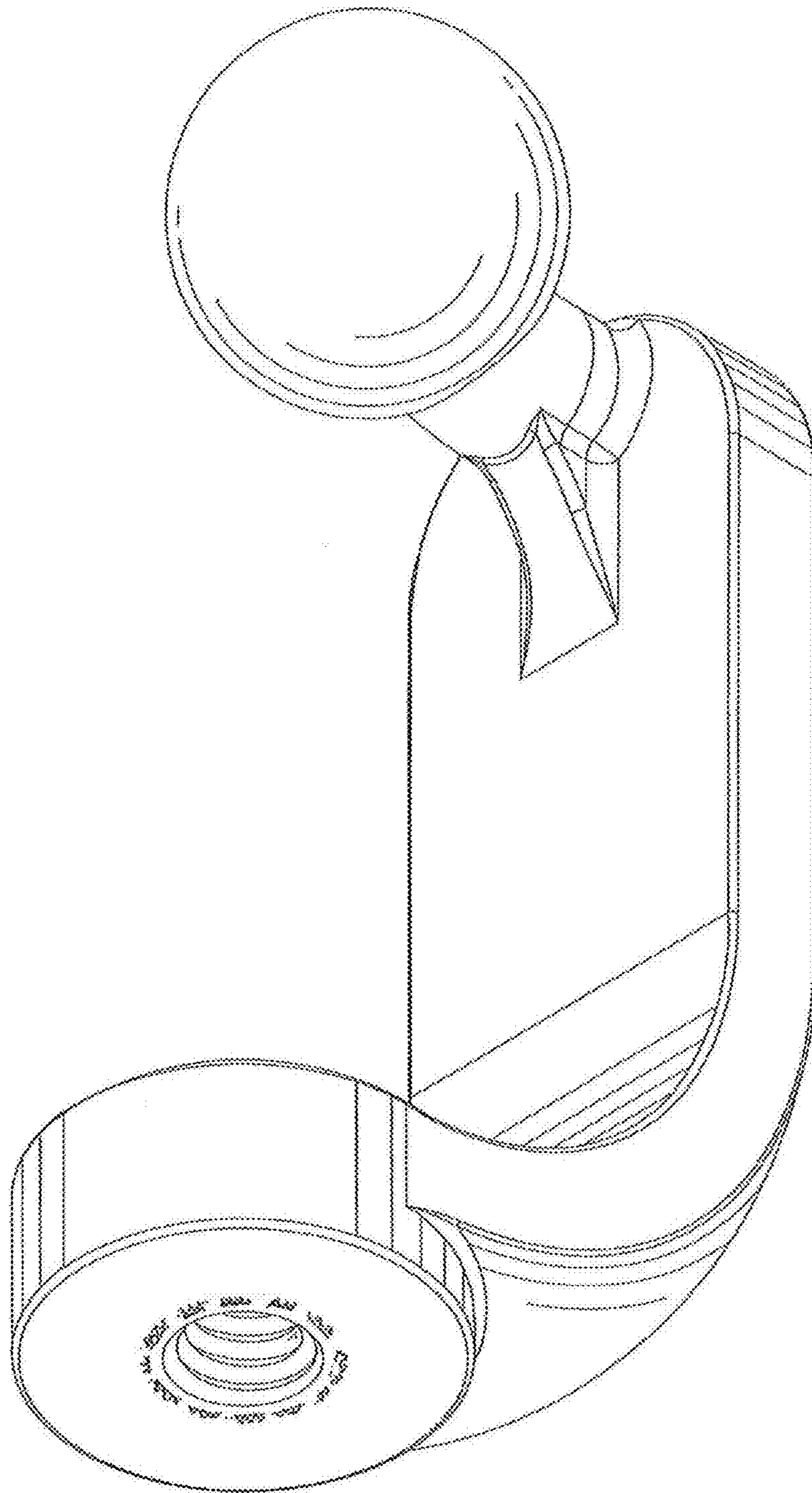

Fig. 2

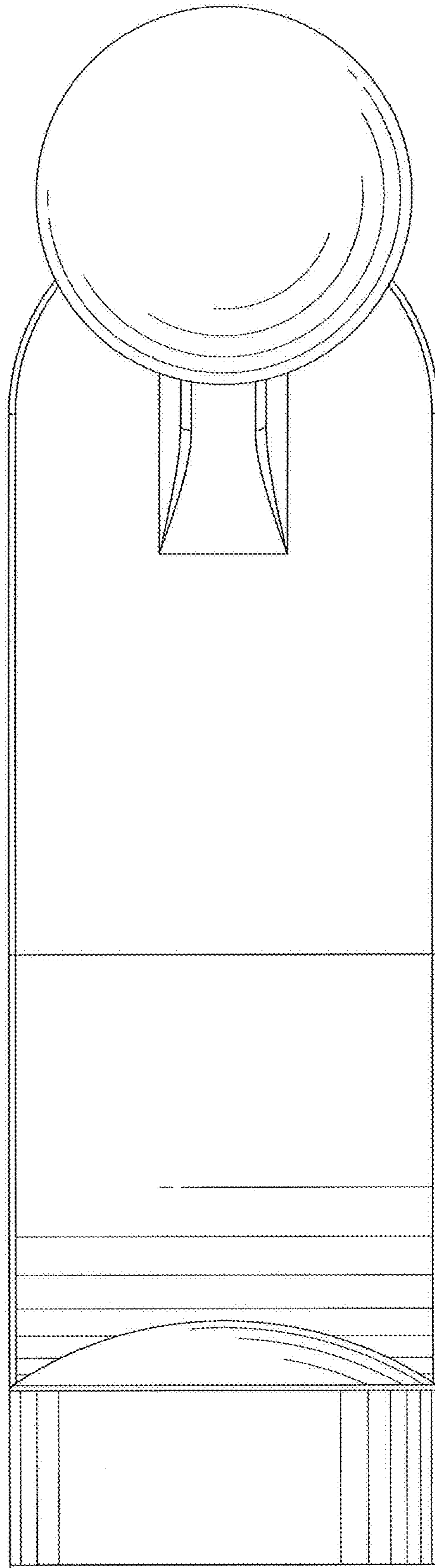

Fig. 3

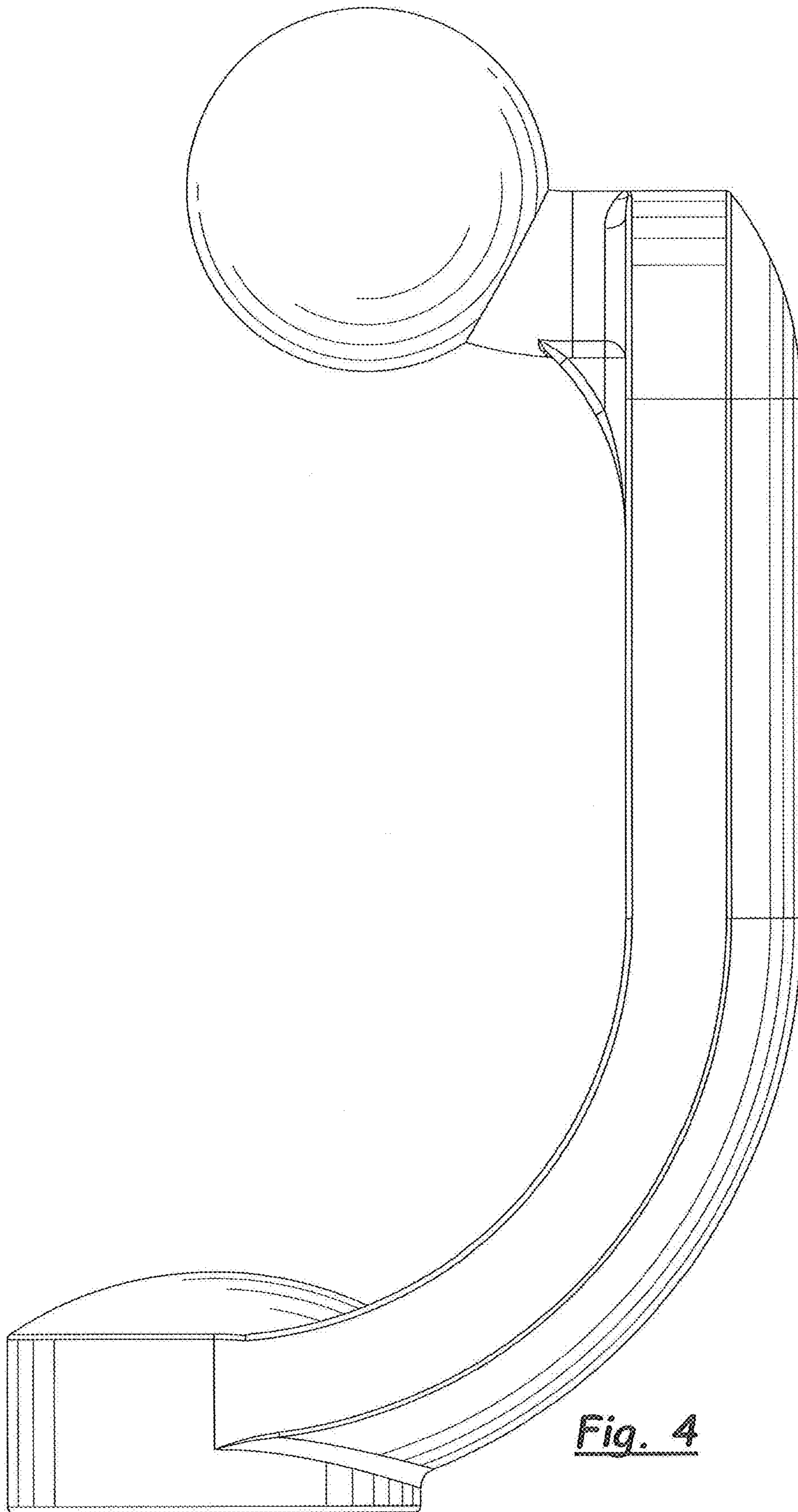

Fig. 4

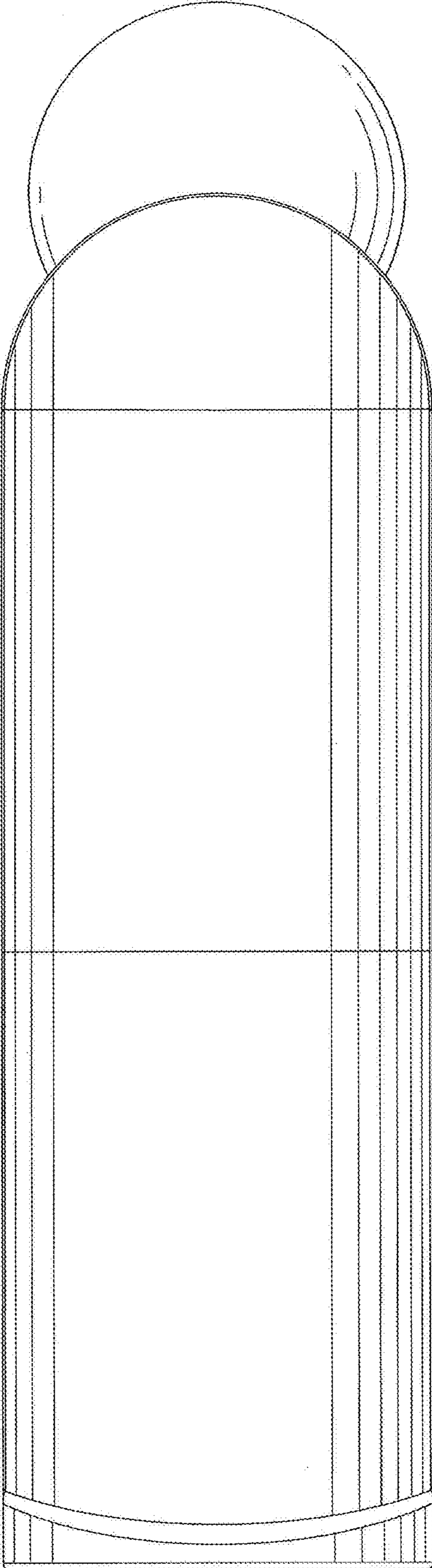

Fig. 5

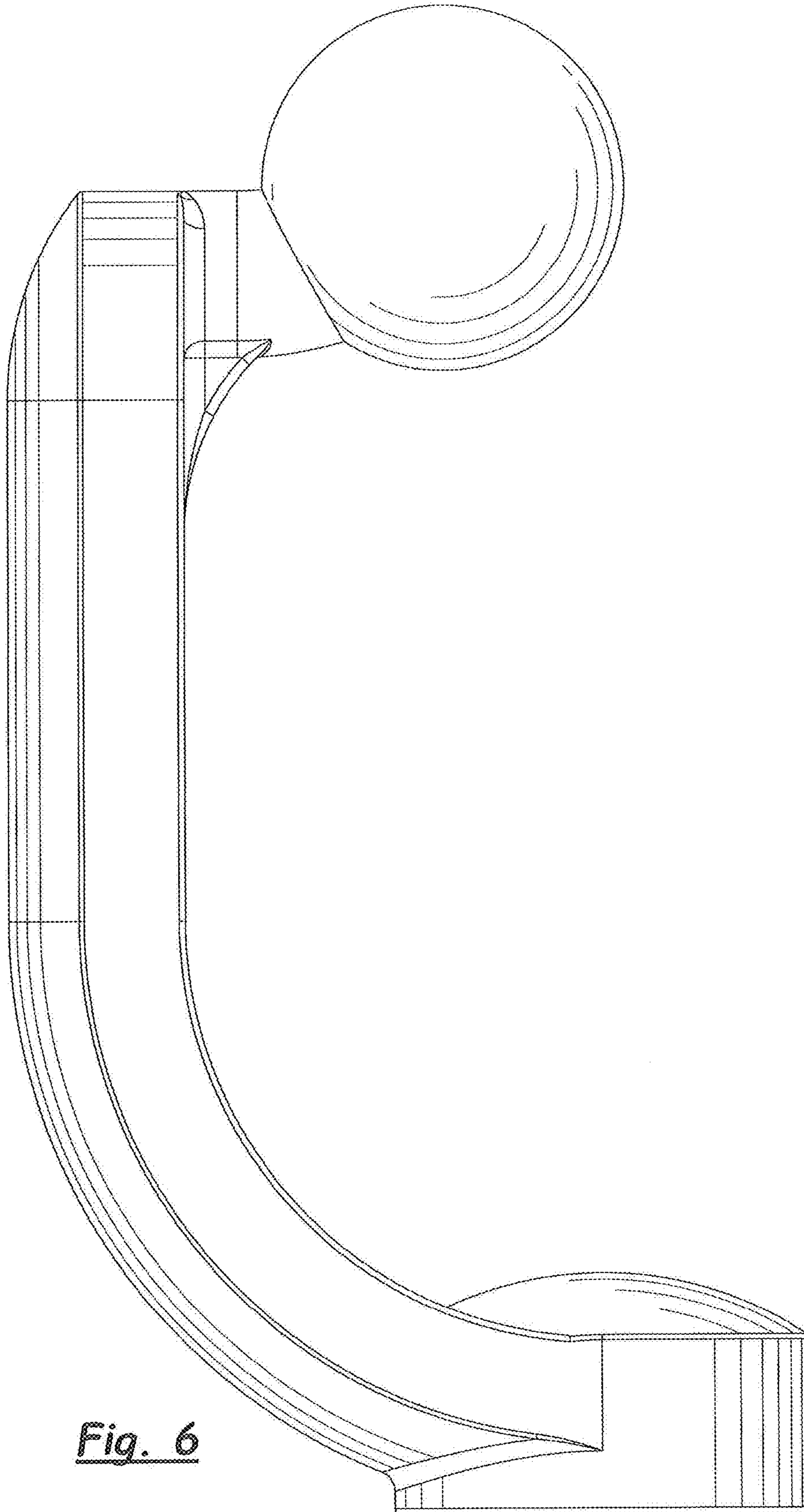

Fig. 6

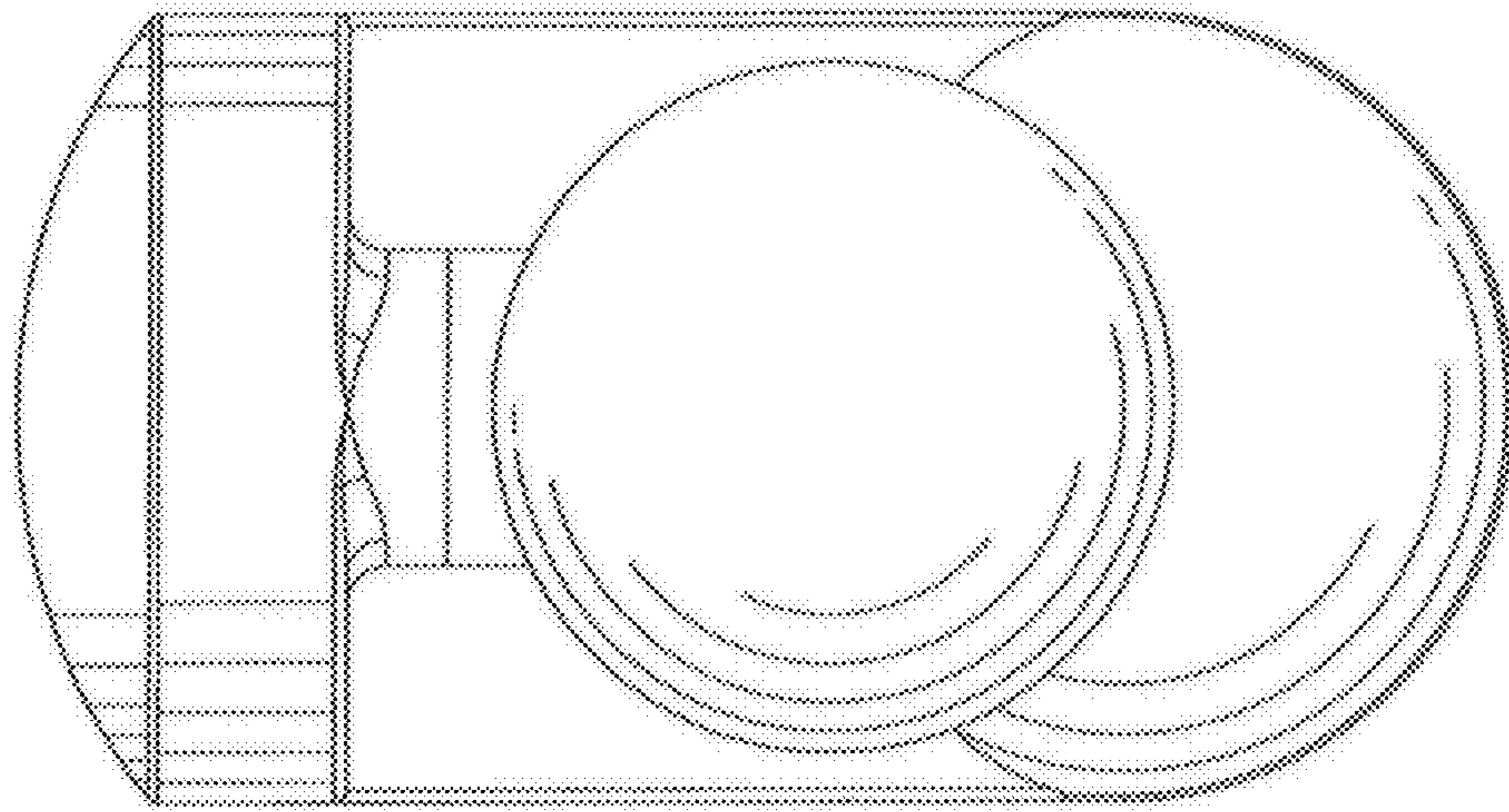

Fig. 7

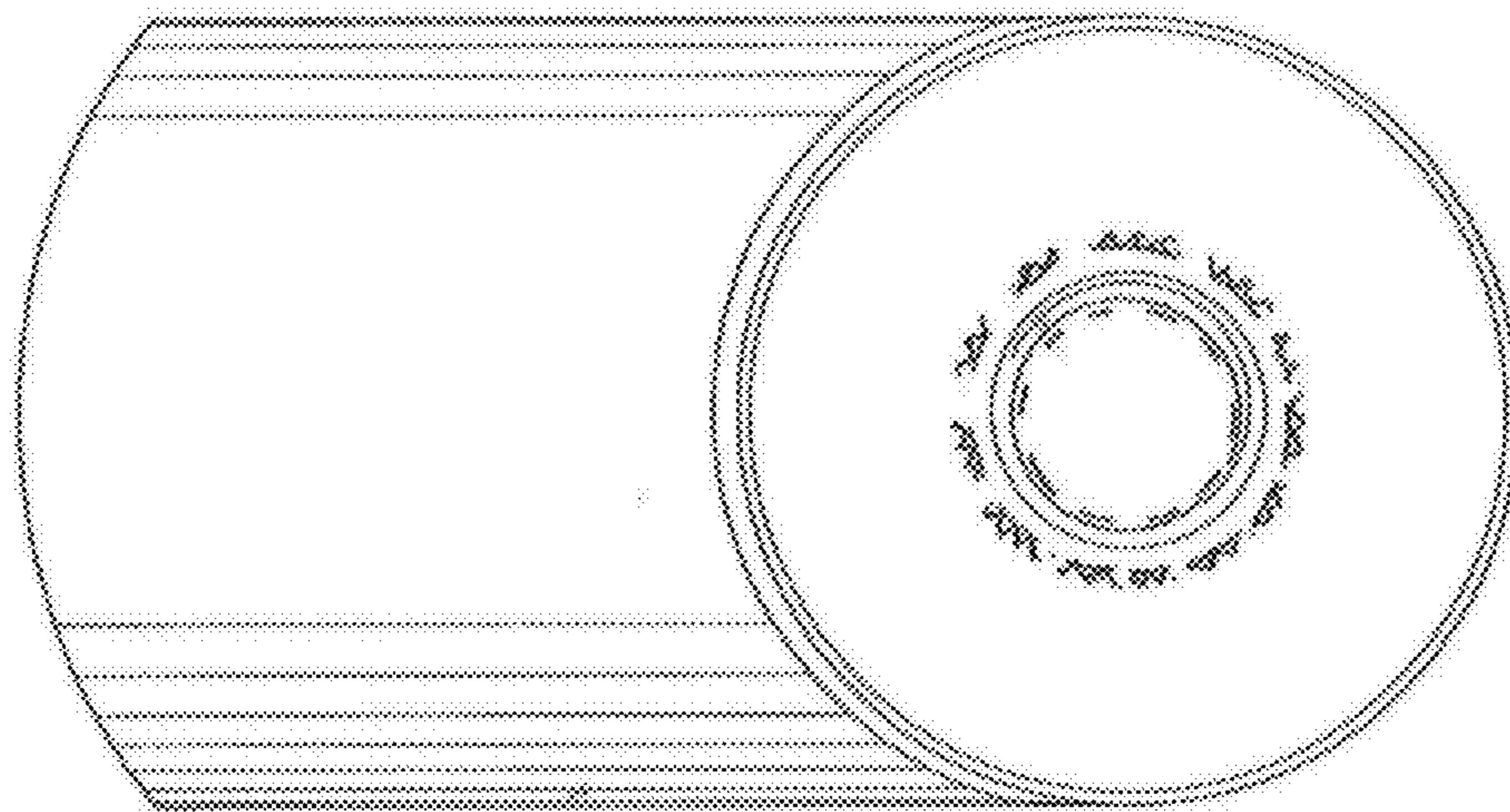

Fig. 8