



US00D835479S

(12) **United States Design Patent**
Kokubo

(10) **Patent No.:** **US D835,479 S**

(45) **Date of Patent:** **** Dec. 11, 2018**

(54) **SPIN COLANDER**

(71) Applicant: **KOKUBO & CO., LTD.**, Wakayama
(JP)

(72) Inventor: **Yoshiaki Kokubo**, Wakayama (JP)

(73) Assignee: **KOKUBO & CO., LTD.**, Wakayama
(JP)

(**) Term: **15 Years**

(21) Appl. No.: **29/625,343**

(22) Filed: **Nov. 8, 2017**

(51) **LOC (11) Cl.** **07-04**

(52) **U.S. Cl.**
USPC **D7/667**

(58) **Field of Classification Search**
USPC D7/665-668, 669, 368, 584, 586, 587
CPC .. A47J 27/16; A47J 31/06; A47J 43/22; A47J
43/24; A47J 43/00; A47J 42/28; A47J
42/286; A47J 36/20; A47J 36/22; B65D
21/086
See application file for complete search history.

(56) **References Cited**

U.S. PATENT DOCUMENTS

D259,535 S * 6/1981 Daenen D7/667
5,992,676 A * 11/1999 Tsai A47G 19/02
220/485

D503,313 S * 3/2005 Shmoon D7/667
D514,764 S * 2/2006 Kumagai D32/55
D584,112 S * 1/2009 Ehrenhaus D7/667
D764,242 S * 8/2016 Frank D7/667

* cited by examiner

Primary Examiner — Terry A Wallace

(74) *Attorney, Agent, or Firm* — Culpepper IP, LLLC;
Kerry S. Culpepper

(57) **CLAIM**

The ornamental design for a spin colander, as shown and described.

DESCRIPTION

FIG. 1 is a perspective view;
FIG. 2 is a front view;
FIG. 3 is a side view;
FIG. 4 is a top view;
FIG. 5 is a bottom view;
FIG. 6 is a front view with the spin colander completely open; and,
FIG. 7 is an exploded perspective view.
The left and right side views are identical.
The front and rear views are identical.

1 Claim, 6 Drawing Sheets

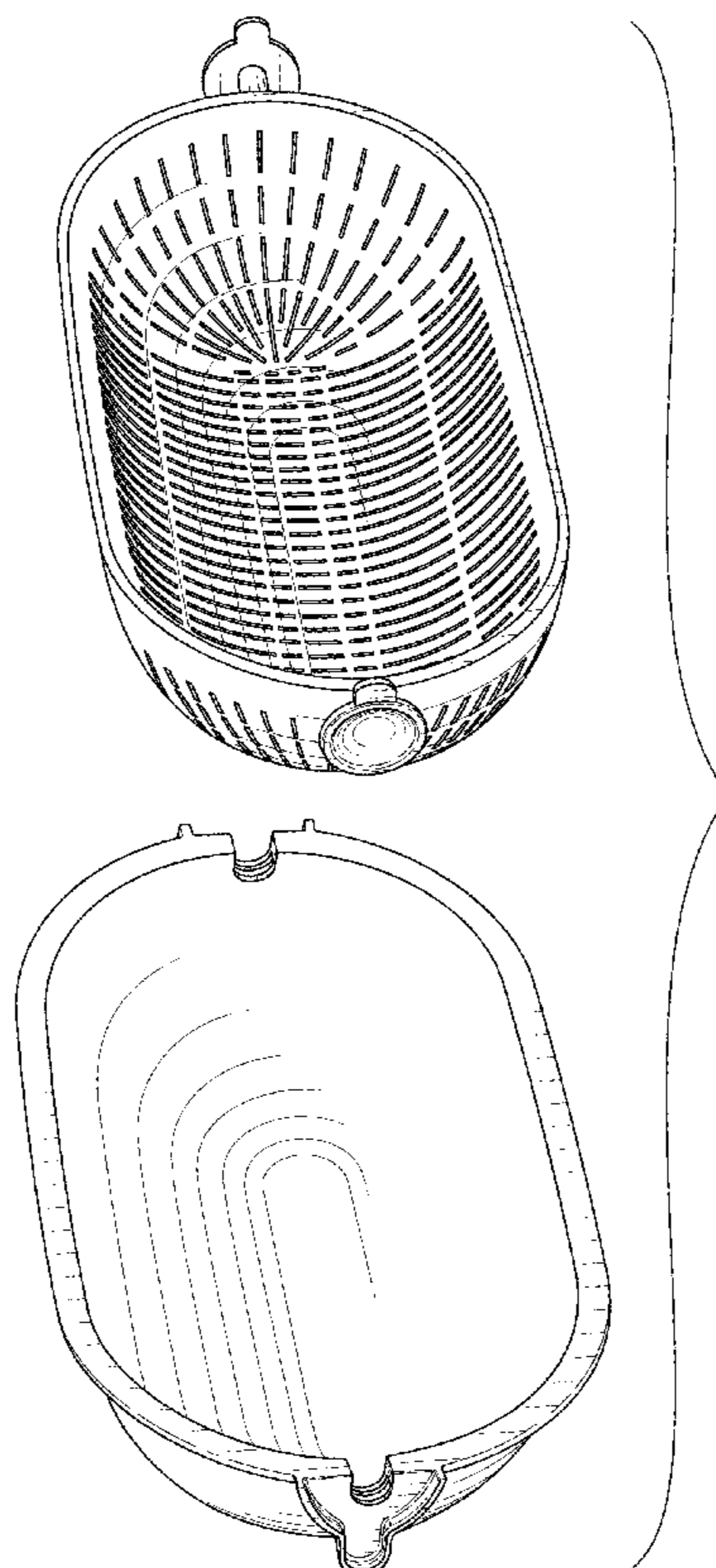

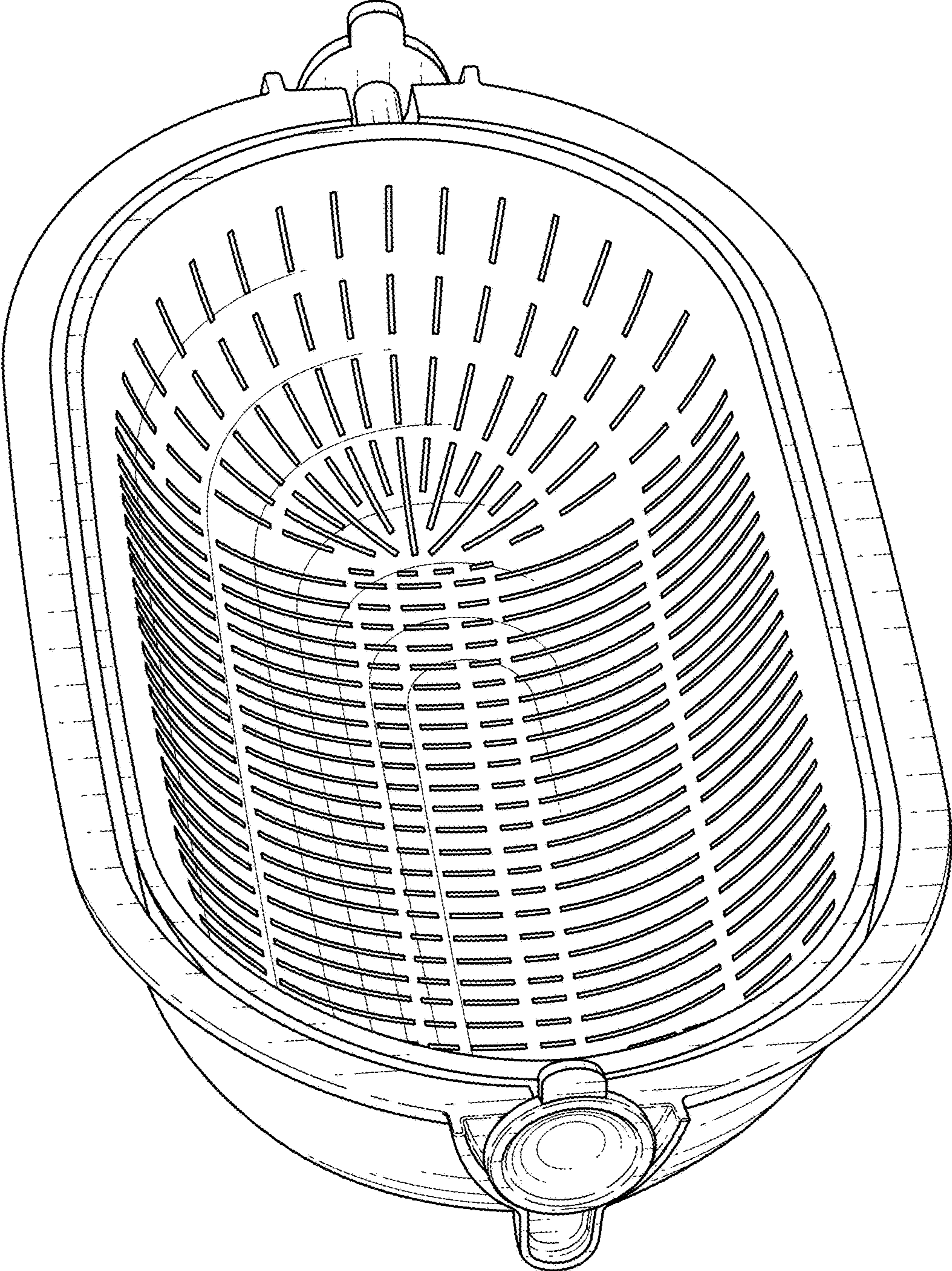

FIG. 1

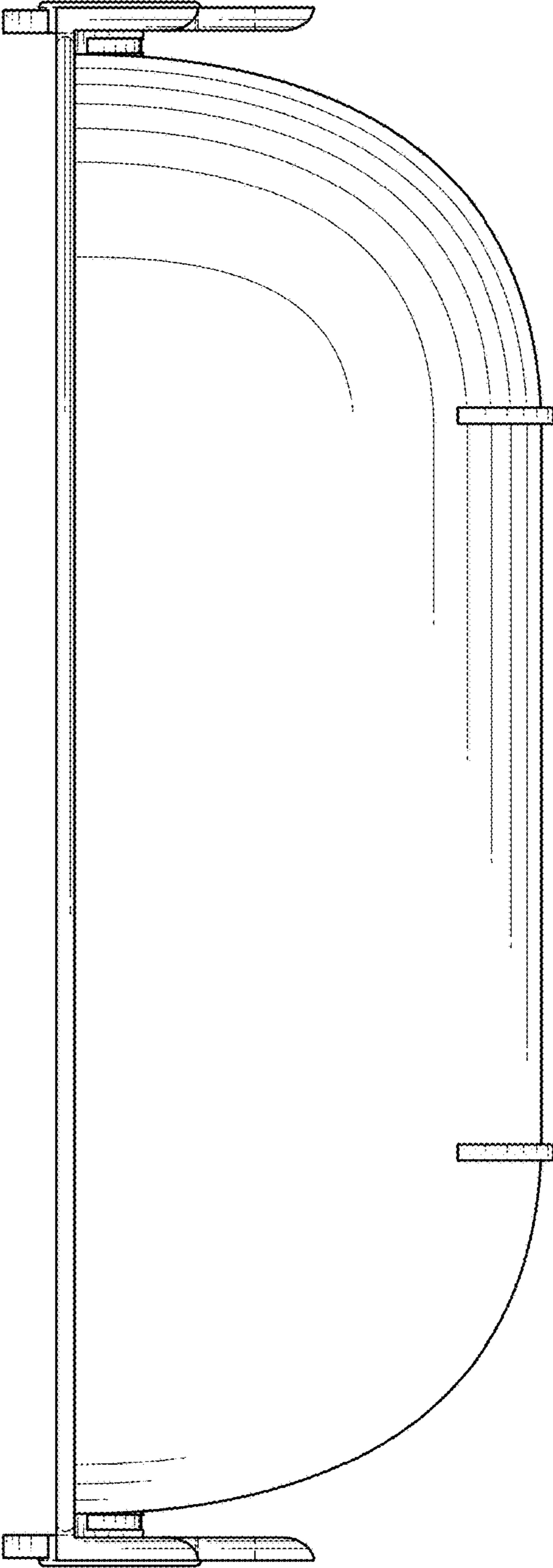

FIG. 2

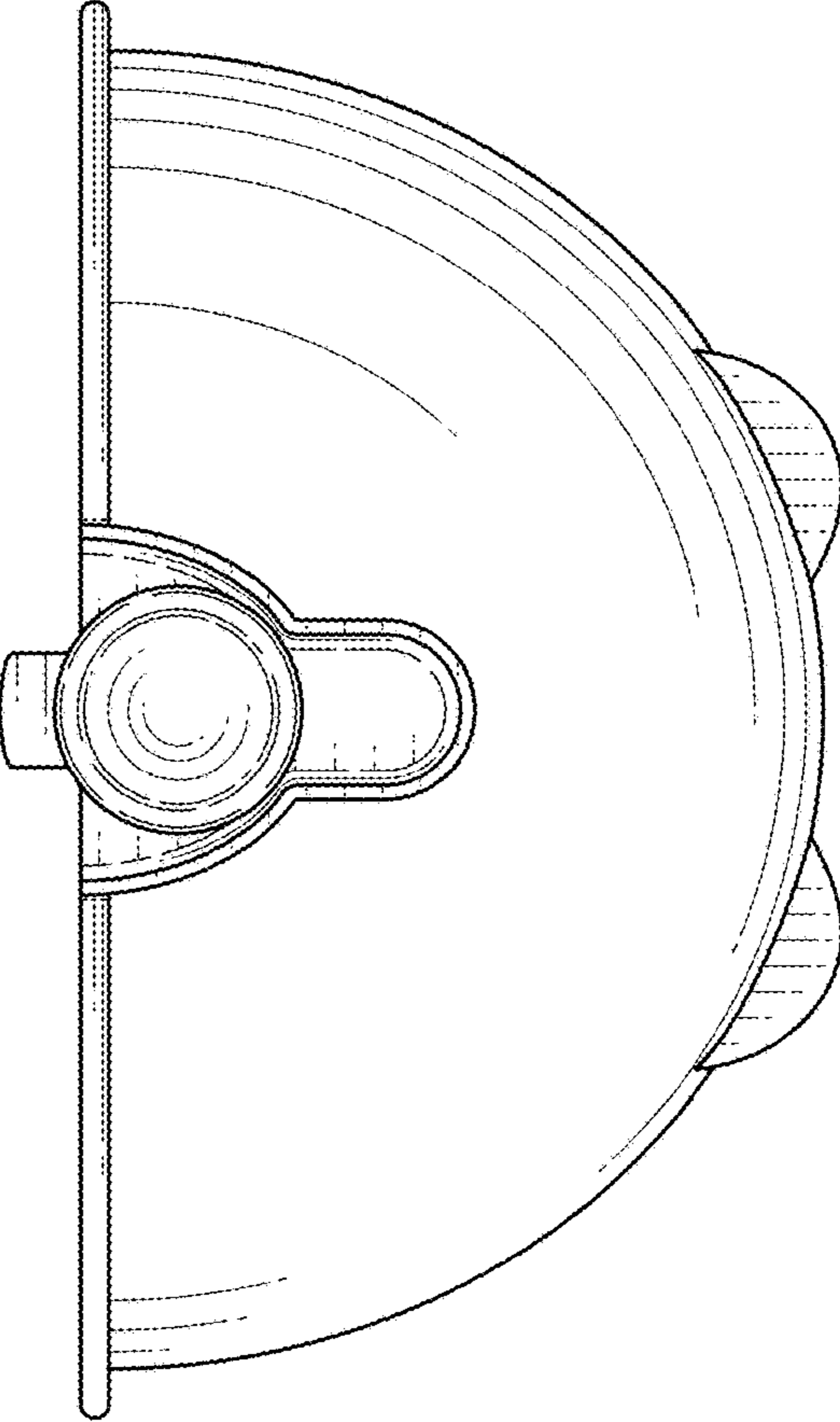

FIG. 3

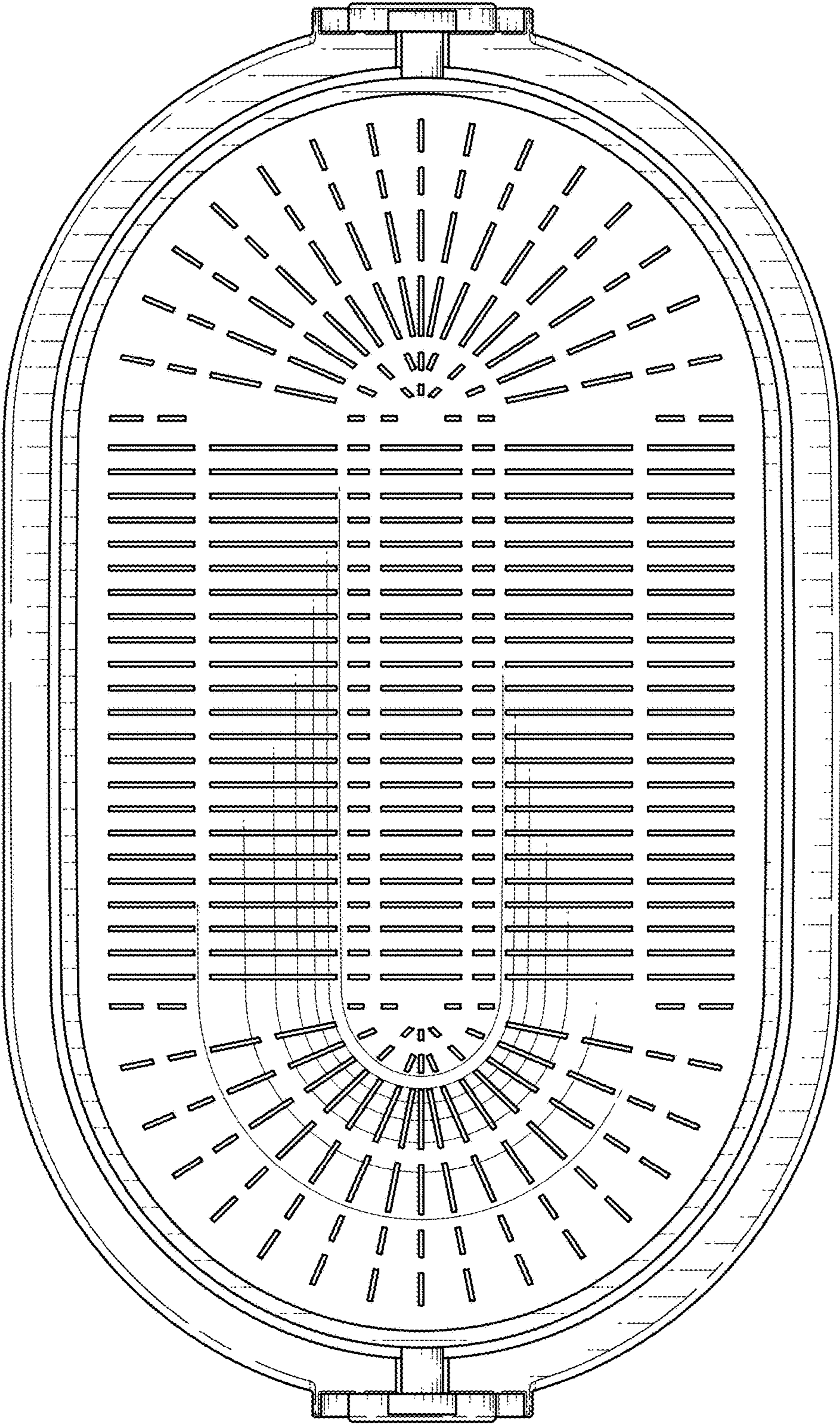

FIG. 4

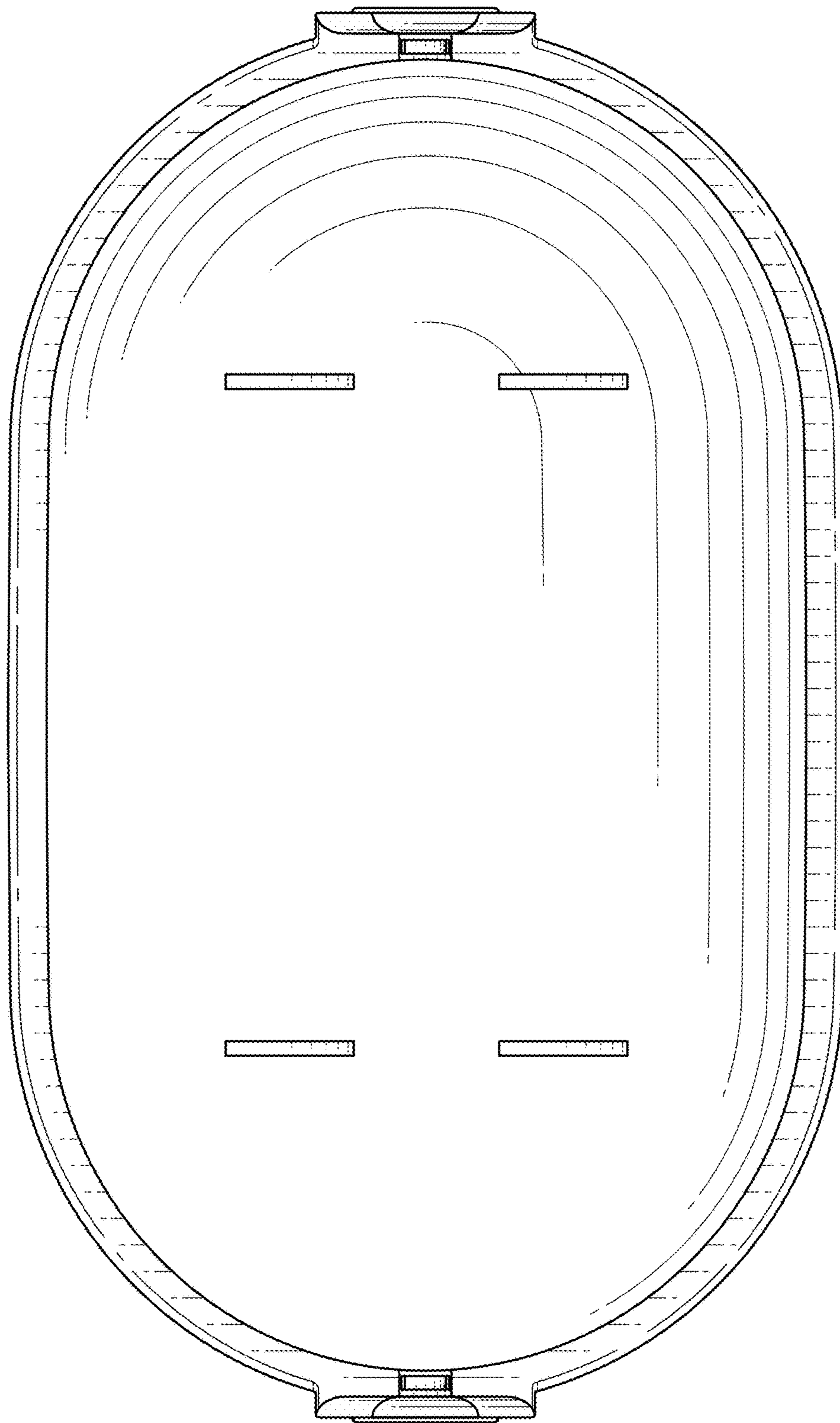

FIG. 5

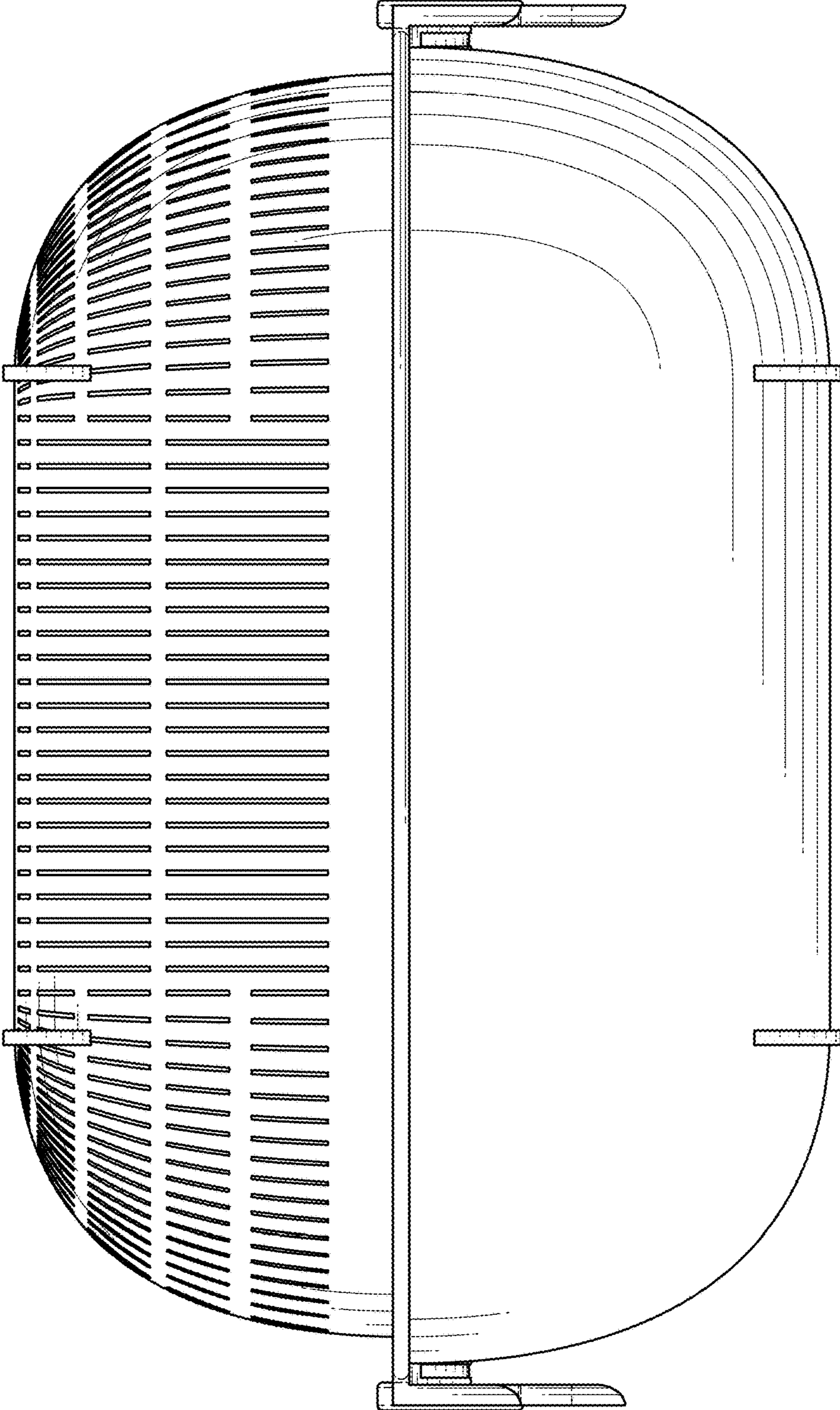

FIG. 6

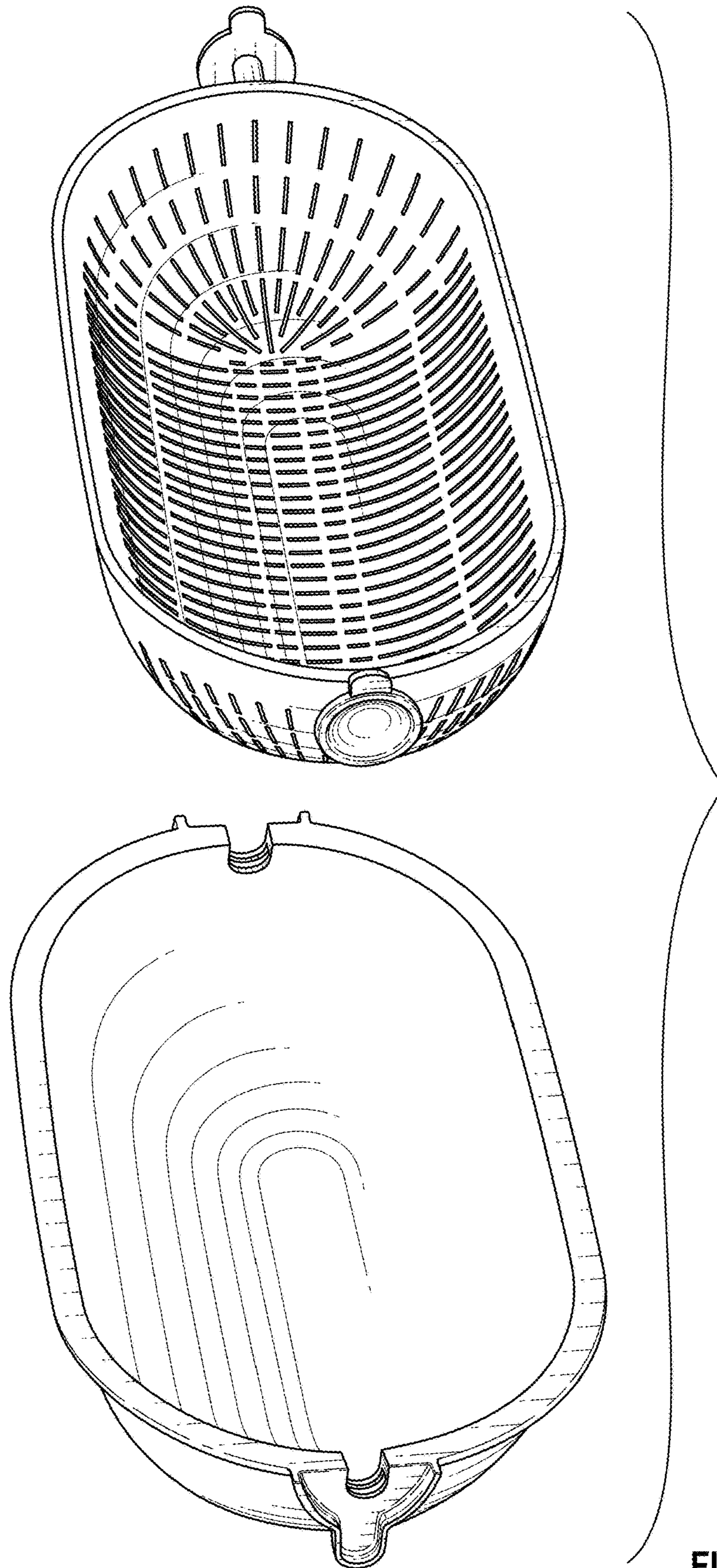

FIG. 7