



US00D835470S

(12) **United States Design Patent** (10) **Patent No.:** **US D835,470 S**
Seiders et al. (45) **Date of Patent:** **** Dec. 11, 2018**

(54) **CONTAINER**

(71) Applicant: **YETI Coolers, LLC**, Austin, TX (US)

(72) Inventors: **Roy Joseph Seiders**, Austin, TX (US);
James William Sonntag, Austin, TX
(US); **Christopher Mall Keller**, Austin,
TX (US); **Steve Charles Nichols**,
Austin, TX (US); **Martin Patrick**
Vespo, Austin, TX (US)

(73) Assignee: **YETI Coolers, LLC**, Austin, TX (US)

(**) Term: **15 Years**

(21) Appl. No.: **29/610,438**

(22) Filed: **Jul. 12, 2017**

(51) **LOC (11) Cl.** **07-01**

(52) **U.S. Cl.**
USPC **D7/605**

(58) **Field of Classification Search**
USPC D7/605-608, 629, 630; D3/272-274
CPC .. A45C 11/20; A45C 5/14; A45C 5/03; A45C
9/00; A47B 77/08; A47G 19/2288; B26B
3/003; F25B 19/00; F25D 3/08; F25D
3/12; F25D 3/02; F25D 3/14; F25D
2331/804; F25D 2400/08; F25D 31/005;
B65D 81/3858; B65D 81/3823; B65D
81/3813; B65D 81/3888; B65D 81/3816
See application file for complete search history.

(56) **References Cited**

U.S. PATENT DOCUMENTS

1,565,686	A	12/1925	Titus
2,070,488	A	2/1937	McIntosh
2,628,062	A	2/1953	Weber
3,111,014	A	11/1963	Herrick
3,439,835	A	4/1969	Reid
3,592,359	A	7/1971	Marraffino
3,863,673	A	2/1975	Sitton
3,923,949	A	12/1975	Kane et al.

D248,440	S	7/1978	Bryan et al.
4,162,029	A	7/1979	Gottsegen et al.
D253,369	S	11/1979	Koelble et al.
4,181,243	A	1/1980	Frahm
D261,391	S	10/1981	Ranua et al.
4,351,455	A	9/1982	Bond
4,367,572	A	1/1983	Zielenski
D270,704	S	9/1983	Ruxton et al.

(Continued)

FOREIGN PATENT DOCUMENTS

DE	10210055	A1	10/2003
DE	102004041583	A1	3/2006

(Continued)

OTHER PUBLICATIONS

Sep. 29, 2017—(PCT) ISR & Written Opinion—App PCT/US2017/
028288.

(Continued)

Primary Examiner — Terry A Wallace

(74) *Attorney, Agent, or Firm* — Banner & Witcoff, Ltd.

(57) **CLAIM**

The ornamental design for a container, as shown and
described.

DESCRIPTION

FIG. 1 is a top, front, right perspective view of a container
showing our new design;
FIG. 2 is a front view thereof;
FIG. 3 is a rear view thereof;
FIG. 4 is a left side view thereof;
FIG. 5 is a right side view thereof;
FIG. 6 is a top view thereof; and,
FIG. 7 is a bottom view thereof.
The broken lines showing the remainder of the container
represent unclaimed subject matter and form no part of the
claimed design.

1 Claim, 7 Drawing Sheets

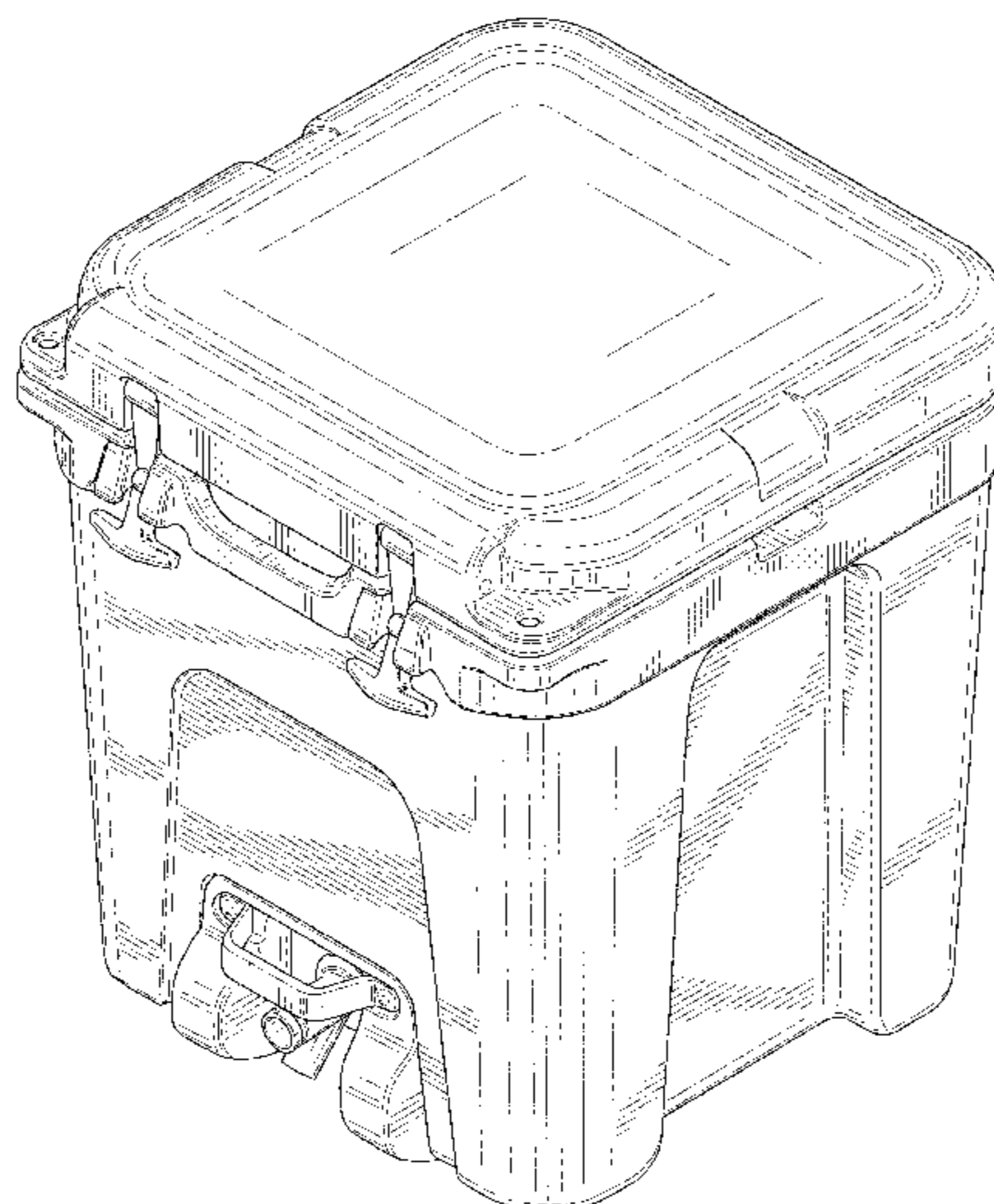

(56)

References Cited

U.S. PATENT DOCUMENTS

4,440,316 A 4/1984 Christine
D290,080 S * 6/1987 Carlson D7/605
4,742,851 A 5/1988 Lundblade
4,805,859 A 2/1989 Hudson
4,936,409 A 6/1990 Nix et al.
5,165,645 A 11/1992 Brown
5,222,631 A 6/1993 Hood
D365,747 S 1/1996 Grande
D368,129 S 3/1996 Peeples
5,535,883 A 7/1996 Henderson
5,607,084 A 3/1997 George
5,827,023 A 10/1998 Stull
5,860,281 A * 1/1999 Coffee A45C 11/20
312/298
5,913,448 A 6/1999 Mann et al.
5,971,218 A 10/1999 Le
6,059,143 A 5/2000 Weir
6,102,356 A 8/2000 Huntley et al.
6,105,844 A 8/2000 Walters et al.
6,126,046 A 10/2000 Baculy
6,126,124 A 10/2000 Wagner
6,176,562 B1 1/2001 Hart
6,302,051 B1 10/2001 Hemmingson
D451,765 S 12/2001 Israel et al.
6,386,557 B1 5/2002 Weldon
6,401,752 B1 6/2002 Blackbourn et al.
6,405,557 B1 6/2002 DeCastro et al.
6,427,886 B1 8/2002 Essex
D468,071 S 12/2002 Le et al.
6,491,189 B2 12/2002 Friedman
6,527,153 B1 3/2003 Manos
D472,762 S 4/2003 Song
6,564,893 B2 5/2003 Lipman
6,666,362 B1 12/2003 LeTrudet
6,755,428 B2 6/2004 Butler
6,845,786 B1 1/2005 Ophardt et al.
D504,713 S 5/2005 Py et al.
6,896,158 B2 5/2005 Leray et al.
D528,368 S * 9/2006 Maldonado D7/605
D546,119 S 7/2007 Dodge
7,269,969 B2 9/2007 Strickland et al.
7,311,229 B1 12/2007 Wrigley
7,328,818 B2 2/2008 Prabucki
7,331,559 B2 2/2008 Hirayu
D566,479 S 4/2008 Kabalin
D571,188 S 6/2008 Brassard
7,455,281 B2 11/2008 Craft
7,669,828 B2 3/2010 Hardy et al.
7,802,709 B1 9/2010 Lewis et al.
D626,406 S 11/2010 Tedesco et al.
7,841,635 B2 11/2010 Fuchs
D628,566 S 12/2010 Molter
D648,006 S 11/2011 Morishita
D651,860 S * 1/2012 Nie D7/605
8,123,236 B1 2/2012 Helenihi
D662,572 S 6/2012 Marquis-Martin
8,230,697 B2 7/2012 Lavallee
D674,245 S * 1/2013 Williams, Jr. D7/605
D693,220 S 11/2013 Luo
D695,568 S 12/2013 Hayes
8,746,498 B2 6/2014 Maldonado et al.
8,827,230 B2 9/2014 Nemoto
8,875,934 B2 * 11/2014 Deka B65D 81/3823
220/23.88
8,950,989 B1 2/2015 Rivera
9,057,552 B2 6/2015 Vanderberg et al.
D738,470 S 9/2015 Eaton et al.
9,126,747 B2 9/2015 Burgess et al.
9,150,163 B2 10/2015 Cronkright, II et al.
9,150,353 B2 10/2015 Jackson
D746,128 S 12/2015 Stanton
9,199,657 B2 12/2015 Martin
9,227,571 B1 1/2016 Wilkens
9,227,768 B2 1/2016 Quick et al.
D749,653 S 2/2016 Carnes

9,278,704 B2 3/2016 Cates
9,352,698 B2 5/2016 Romanelli
D767,973 S 10/2016 DeDios-Shirley et al.
D772,383 S 11/2016 Gill
D773,621 S 12/2016 Gill
D775,952 S 1/2017 Kim
9,533,814 B2 1/2017 Brooks
9,543,558 B2 1/2017 Templeman et al.
9,550,508 B1 1/2017 Parra
D782,620 S 3/2017 Becker et al.
D785,140 S 4/2017 Gross
D787,648 S 5/2017 Smith
9,750,371 B2 9/2017 Bungard et al.
9,878,841 B2 1/2018 Holderness et al.
2002/0038745 A1 4/2002 Lamming
2004/0232637 A1 11/2004 Butler
2004/0251444 A1 12/2004 Levey et al.
2005/0127081 A1 * 6/2005 Leba F25D 3/08
220/761
2006/0260327 A1 11/2006 Kanamori et al.
2006/0261088 A1 11/2006 Chin
2006/0261111 A1 11/2006 McCoy et al.
2007/0045368 A1 3/2007 Lavelle
2007/0095998 A1 5/2007 Gray
2007/0152002 A1 7/2007 Dollar
2007/0152003 A1 7/2007 Dollar
2007/0181615 A1 8/2007 Allanson et al.
2007/0187435 A1 8/2007 Quirk
2008/0178629 A1 7/2008 Meether
2009/0241584 A1 10/2009 Hayes et al.
2010/0212351 A1 8/2010 Chapin et al.
2010/0215455 A1 8/2010 Burris
2011/0062156 A1 3/2011 Smeaton
2011/0240684 A1 10/2011 McSavaney
2012/0111892 A1 5/2012 Leith, Sr. et al.
2014/0252010 A1 9/2014 Miller
2015/0048118 A1 2/2015 English et al.
2015/0182012 A1 7/2015 Thornton et al.
2015/0375918 A1 * 12/2015 Holderness B67D 3/0067
222/566
2016/0114347 A1 4/2016 Kosarnig
2016/0220925 A1 8/2016 Savoy et al.
2016/0340217 A1 11/2016 Kuennen et al.
2017/0203308 A1 7/2017 Huang

FOREIGN PATENT DOCUMENTS

EP 2873626 A1 5/2015
GB 484091 A 4/1938
WO 10044074 A1 4/2010

OTHER PUBLICATIONS

MVP 7812 package—3 Burner Grill, Tailgate Transport & Ice Chest Tray [online], [retrieved Oct. 12, 2017], Retrieved from the Internet, URL: <<http://partykinggrills.com/shop/mvp-grill-tailgate-transport-ice-chest-tray/>>; 5 color pages, published date unknown, but for purposes of patent prosecution presumably more than a year prior to the filing date of the present application.
Great Day Hitch-N-Ride Cargo Carriers—HNR100TF [online], [retrieved Oct. 12, 2017], Retrieved from the Internet, URL: <<http://www.autoanything.com/roof-racks/77A7418A4464928.aspx>>; 3 color pages, published date unknown, but for purposes of patent prosecution presumably more than a year prior to the filing date of the present application.
Rubbermaid FG9F1900BLA ProServe Black Dolly with Retention Strap for 9F12, 9F13, 9F14, 9F15, and 9F16 Insulated Food Pan Carrier [online], [retrieved Oct. 12, 2017], Retrieved from the Internet, URL: <<https://www.webstaurantstore.com/rubbermaid-9f19-proserve-black-dolly-with-retention-strap-for-9f12-9f13-9f14-9f15-and-9f16-insulated-food-pan-carrier-fg9f1900bla-6909F19.html>>; 4 color pages, published date unknown, but for purposes of patent prosecution presumably more than a year prior to the filing date of the present application.

(56)

References Cited

OTHER PUBLICATIONS

Yeti Cooler Mounted in Baja Basket—Photo 08 [online], [retrieved Oct. 12, 2017], Retrieved from the Internet, URL: <<http://www.fourwheeler.com/how-to/body-chassis/1503-adding-synergy-manufacturings-baja-basket-storage-solution/photo-08.html>>; 6 color pages, published date unknown, but for purposes of patent prosecution presumably more than a year prior to the filing date of the present application.

Now Selling Cooler Commander (7 Pictures) [online], [retrieved Oct. 12, 2017], Retrieved from the Internet, URL: <<http://www.rzrforums.net/utv-family/304697-now-selling-cooler-commander-7-pictures.html>>; 7 color pages, published date unknown, but for purposes of patent prosecution presumably more than a year prior to the filing date of the present application.

Engel USA Cooler Tie-Down Strap Kit [online], [retrieved Oct. 12, 2017], Retrieved from the Internet, URL: <<https://www.amazon.com/Engel-USA-Cooler-Tie-Down-Strap/dp/B0078T3MWY>>; 6 color pages, published date unknown, but for purposes of patent prosecution presumably more than a year prior to the filing date of the present application.

Yeti Cooler Slide Out Mounting Kit [online], [retrieved Oct. 12, 2017], Retrieved from the Internet, URL: <<http://archive.constantcontact.com/fs085/1102686599059/archive/1108110340931.html>>; 5 color pages, published date unknown, but for purposes of patent prosecution presumably more than a year prior to the filing date of the present application.

ARB [online], [retrieved Oct. 12, 2017], Retrieved from the Internet, URL: <https://www.streetsideauto.com/p/arb-10900010/?utm_source=googlepepla&utm_medium=adword&gclid=CPT3omE69MCFRtYDQodyVIBUg>; 2 color pages, published date unknown, but for purposes of patent prosecution presumably more than a year prior to the filing date of the present application.

* cited by examiner



FIG. 1

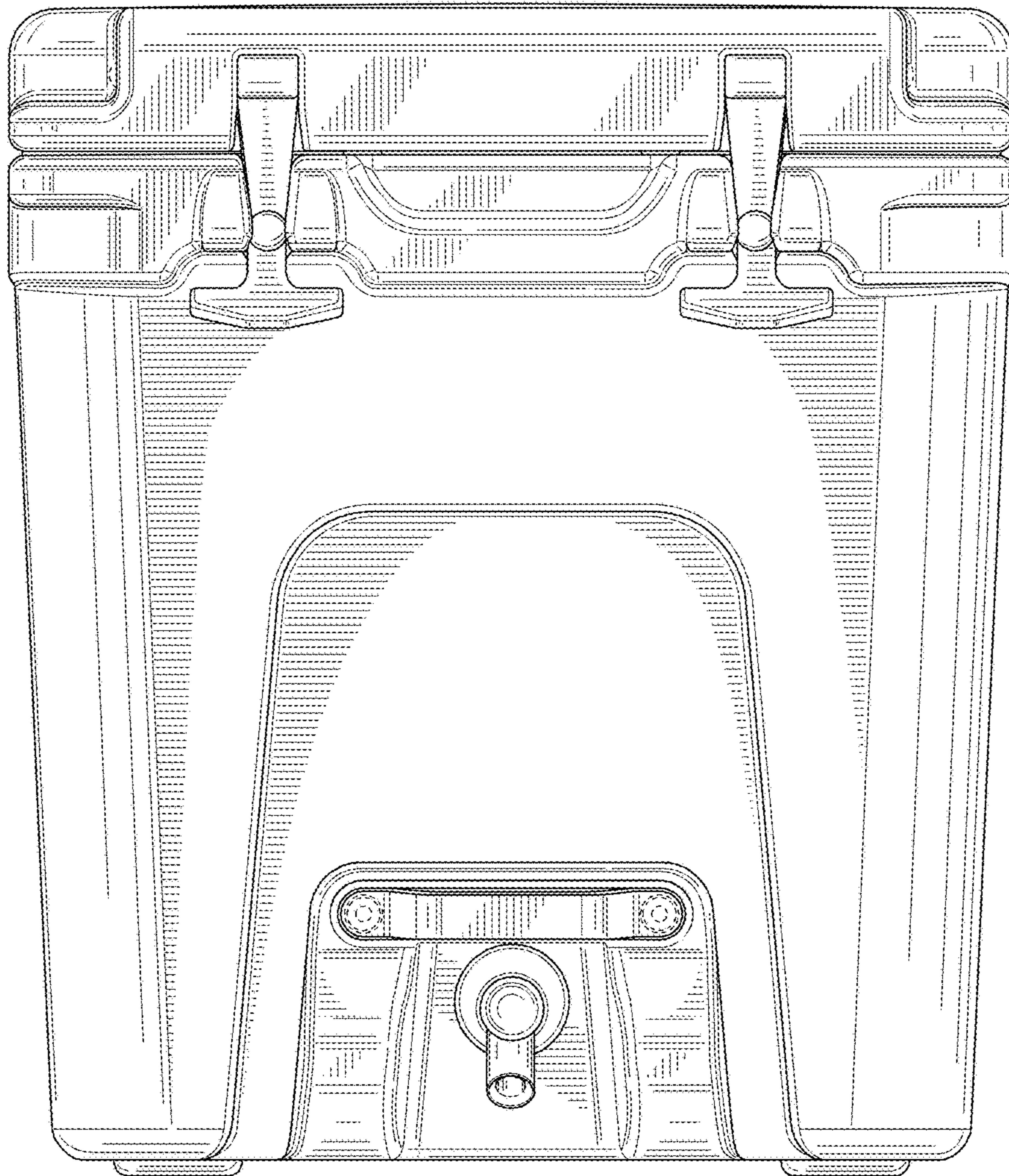

FIG. 2

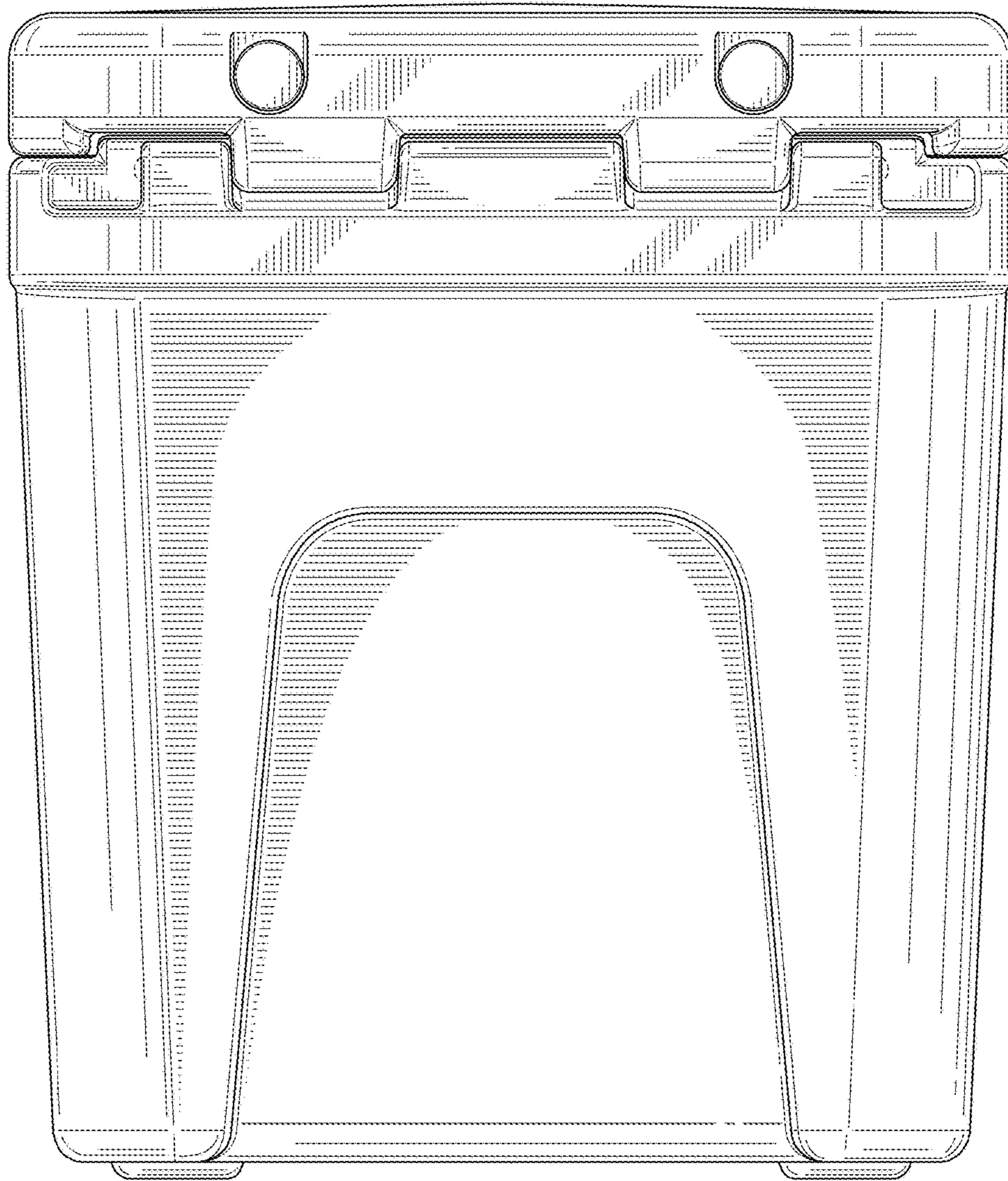

FIG. 3

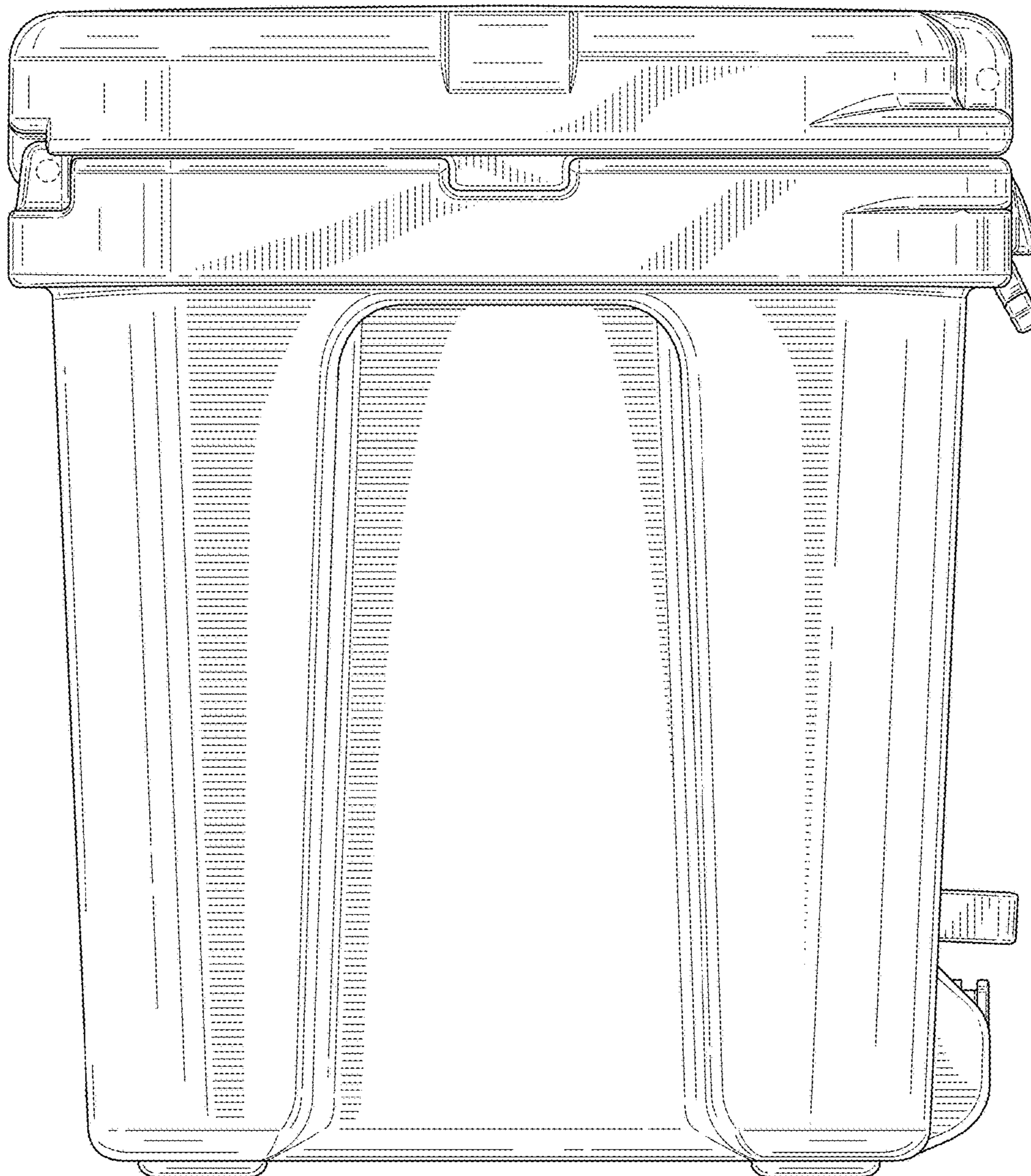

FIG. 4

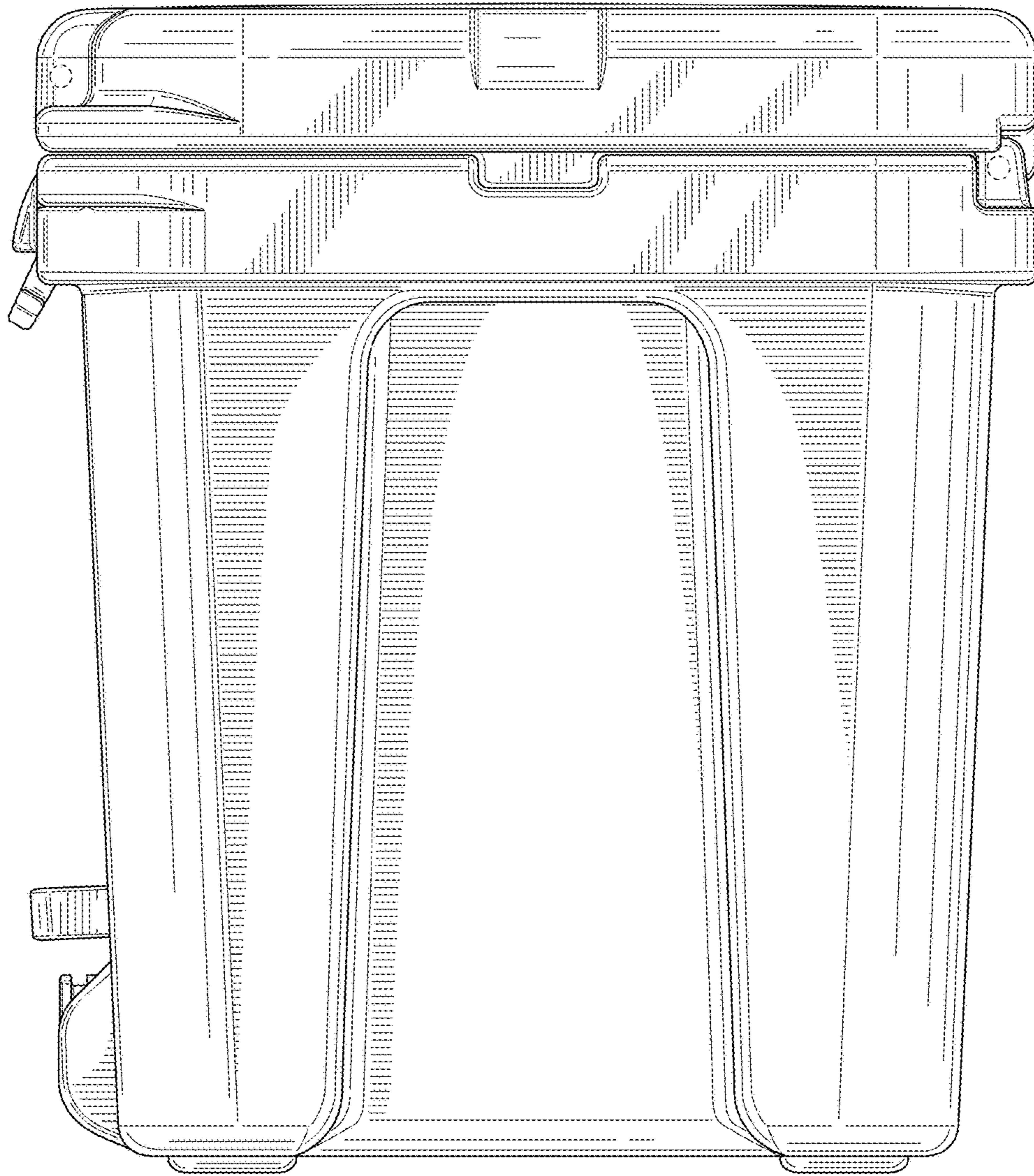

FIG. 5

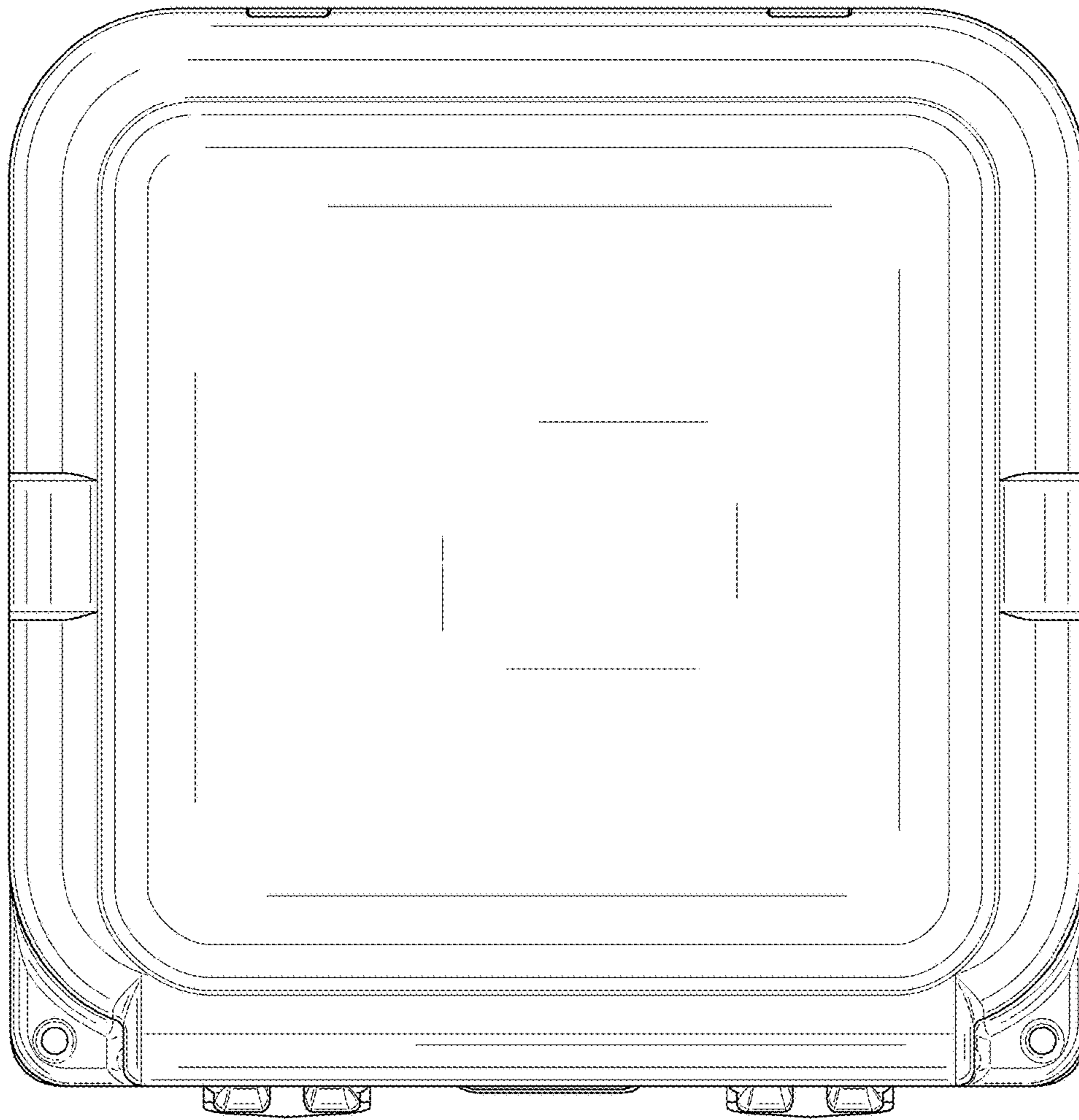

FIG. 6

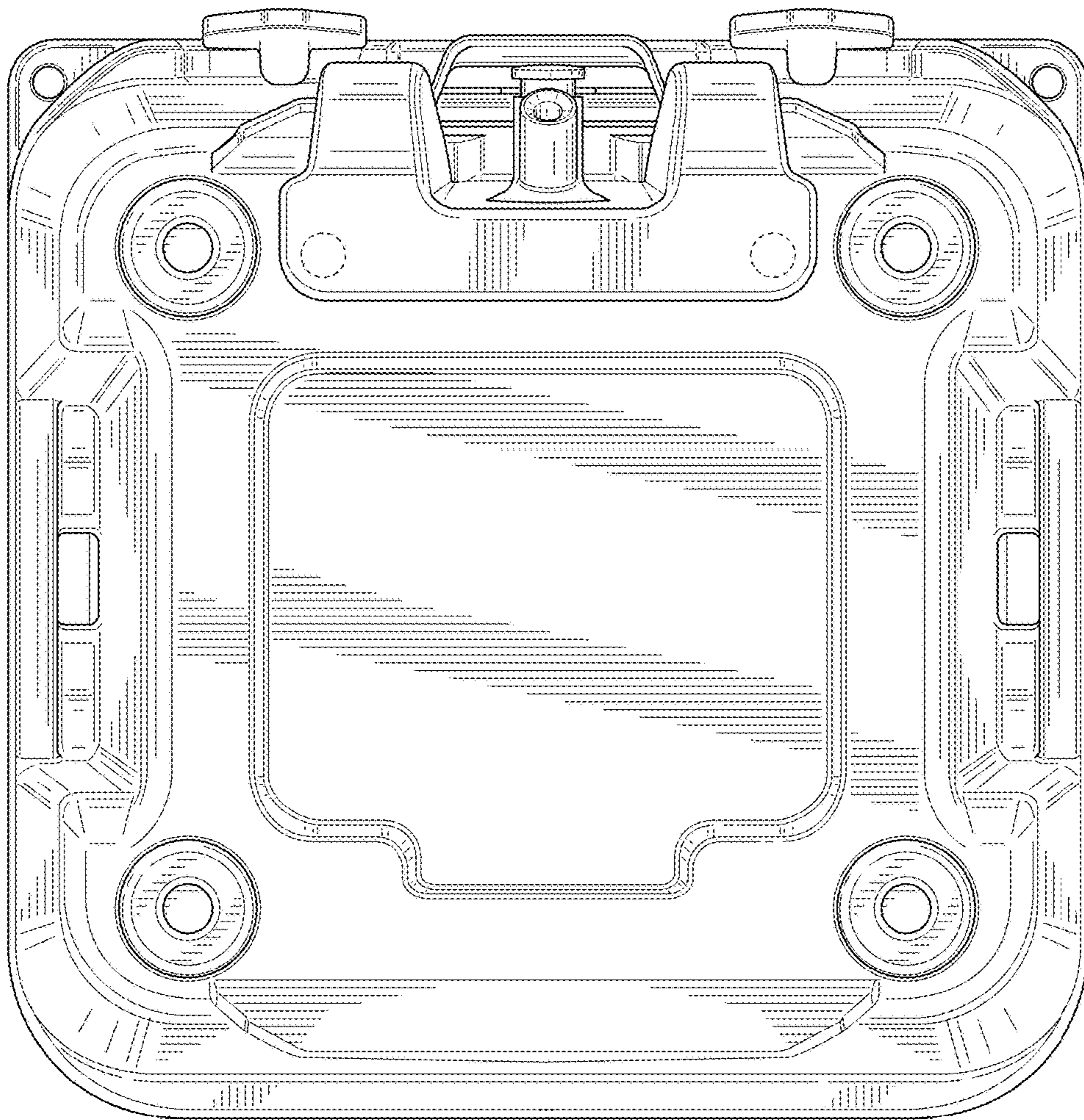

FIG. 7