



US00D835416S

(12) **United States Design Patent**  
**Oshima**

(10) **Patent No.:** **US D835,416 S**

(45) **Date of Patent:** **\*\* Dec. 11, 2018**

(54) **PAIR OF CARRYING HANDLES FOR A SUITCASE**

(71) Applicant: **SIFFLER Inc.**, Koshigaya-shi, Saitama (JP)

(72) Inventor: **Naoyuki Oshima**, Koshigaya (JP)

(73) Assignee: **SIFFLER INC.**, Koshigaya-Shi, Saitama (JP)

(\*\*) Term: **15 Years**

(21) Appl. No.: **29/572,570**

(22) Filed: **Jul. 28, 2016**

(30) **Foreign Application Priority Data**

Jan. 29, 2016 (JP) ..... 2016-001874

(51) **LOC (11) Cl.** ..... **03-01**

(52) **U.S. Cl.**  
USPC ..... **D3/328**

(58) **Field of Classification Search**

USPC ..... D3/221, 229, 232-246, 254, 255, 273,  
D3/281, 294, 300, 315, 318, 319, 320,  
D3/321, 322, 323, 324, 327, 328, 328.1,  
D3/329, 902-905

CPC ... A63B 47/001; A63B 57/0037; A63B 57/20;  
A63B 57/203

See application file for complete search history.

(56) **References Cited**

**U.S. PATENT DOCUMENTS**

D353,488 S \* 12/1994 Lin ..... D3/276  
D373,248 S \* 9/1996 Wang ..... D3/318  
D417,338 S \* 12/1999 Main ..... D3/276  
D422,450 S \* 4/2000 Conti ..... 16/110.1  
D446,935 S \* 8/2001 Huang ..... 3/281  
D491,367 S \* 6/2004 Moon ..... D3/318  
D504,773 S \* 5/2005 Lu ..... D3/318  
D554,372 S \* 11/2007 Scicluna ..... D3/318

D609,474 S \* 2/2010 Chu ..... D3/318  
D634,544 S \* 3/2011 Scicluna ..... D3/318  
D637,398 S \* 5/2011 Jiang ..... D3/318  
D639,556 S \* 6/2011 Sosnovsky ..... D3/281

(Continued)

**OTHER PUBLICATIONS**

Carbon Fiber Briefcase by THoke, posted at Coroflot.com, posting date Jan. 15, 2015, [online], [site visited Aug. 9, 2017]. Available from Internet, <URL:http://www.coroflot.com/THoke/Carbon-Fiber-Briefcase (Year: 2015).\*

*Primary Examiner* — Susan E Krakower

*Assistant Examiner* — L. A. Grabenstetter

(74) *Attorney, Agent, or Firm* — Birch, Stewart, Kolasch & Birch, LLP

(57) **CLAIM**

The ornamental design for a pair of carrying handles for a suitcase, as shown and described.

**DESCRIPTION**

FIG. 1 is a front, right perspective view of a pair of carrying handles for a suitcase, showing my new design, with the handle shown rotated upright;

FIG. 2 is a front elevation view thereof;

FIG. 3 is a top plan view thereof;

FIG. 4 is a bottom plan view thereof;

FIG. 5 is a bottom perspective view thereof;

FIG. 6 is a second front perspective view thereof, with the handle shown rotated upright;

FIG. 7 is an enlarged perspective view thereof, with the handle shown rotated upright; and,

FIG. 8 is a second enlarged perspective view thereof, with the handle shown rotated down.

The broken lines shown in the drawings illustrate portions of the suitcase that are environmental structures and form no part of the claimed design.

**1 Claim, 8 Drawing Sheets**

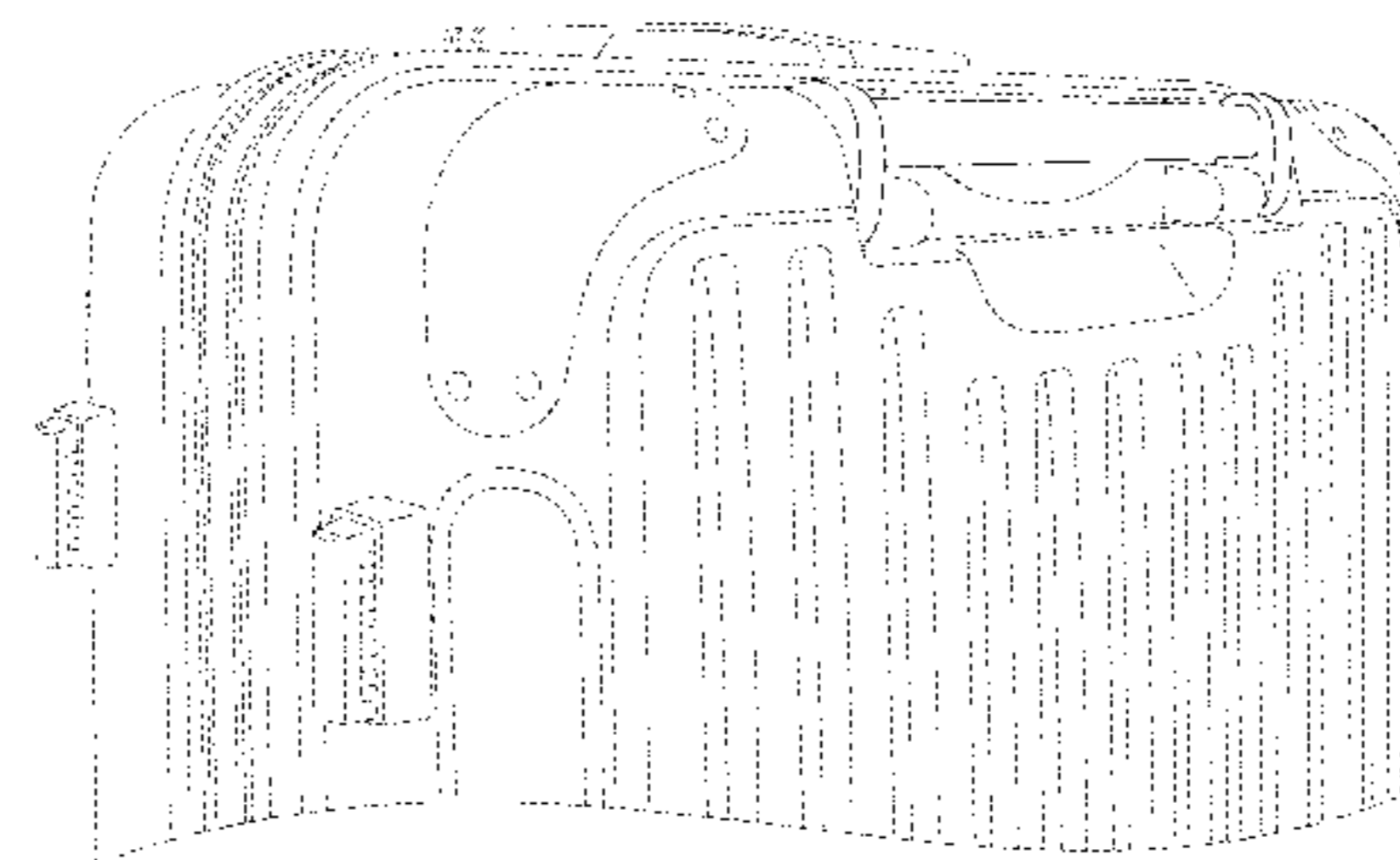

(56)

**References Cited**

U.S. PATENT DOCUMENTS

D710,610 S *	8/2014	Sijmons .....	D3/279
D711,105 S *	8/2014	Brunner .....	D3/281
D714,063 S *	9/2014	Ke .....	D3/318
D741,600 S *	10/2015	Della Vecchia .....	D3/318
D744,238 S *	12/2015	Lai .....	D3/318
D752,862 S *	4/2016	Riddiford .....	D3/272
D762,983 S *	8/2016	Szyf .....	D3/318
D771,950 S *	11/2016	Lai .....	D3/321
D773,819 S *	12/2016	Sener .....	D3/318
D774,304 S *	12/2016	Wang .....	D3/318

\* cited by examiner

FIG. 1

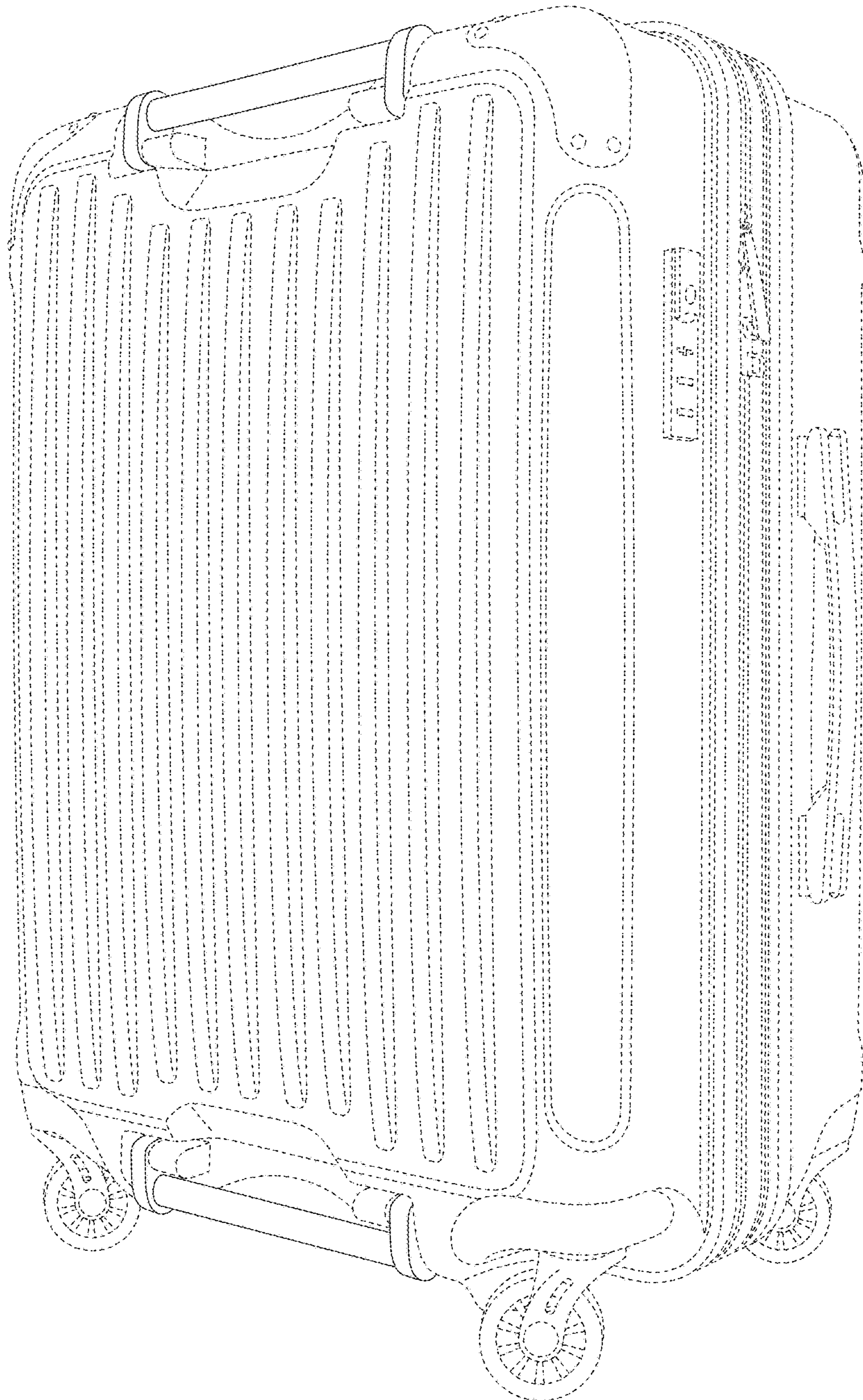

FIG. 2

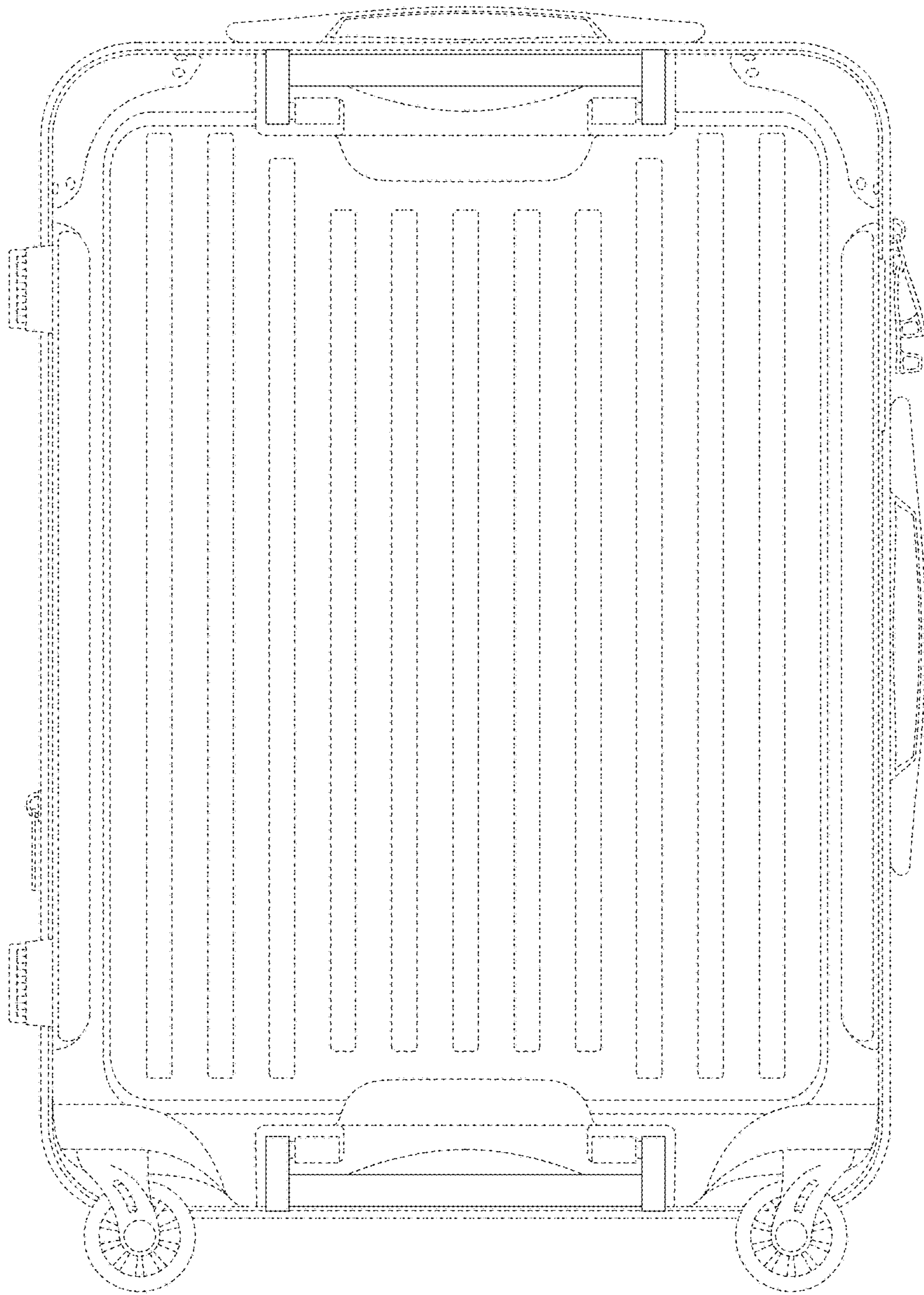

FIG. 3

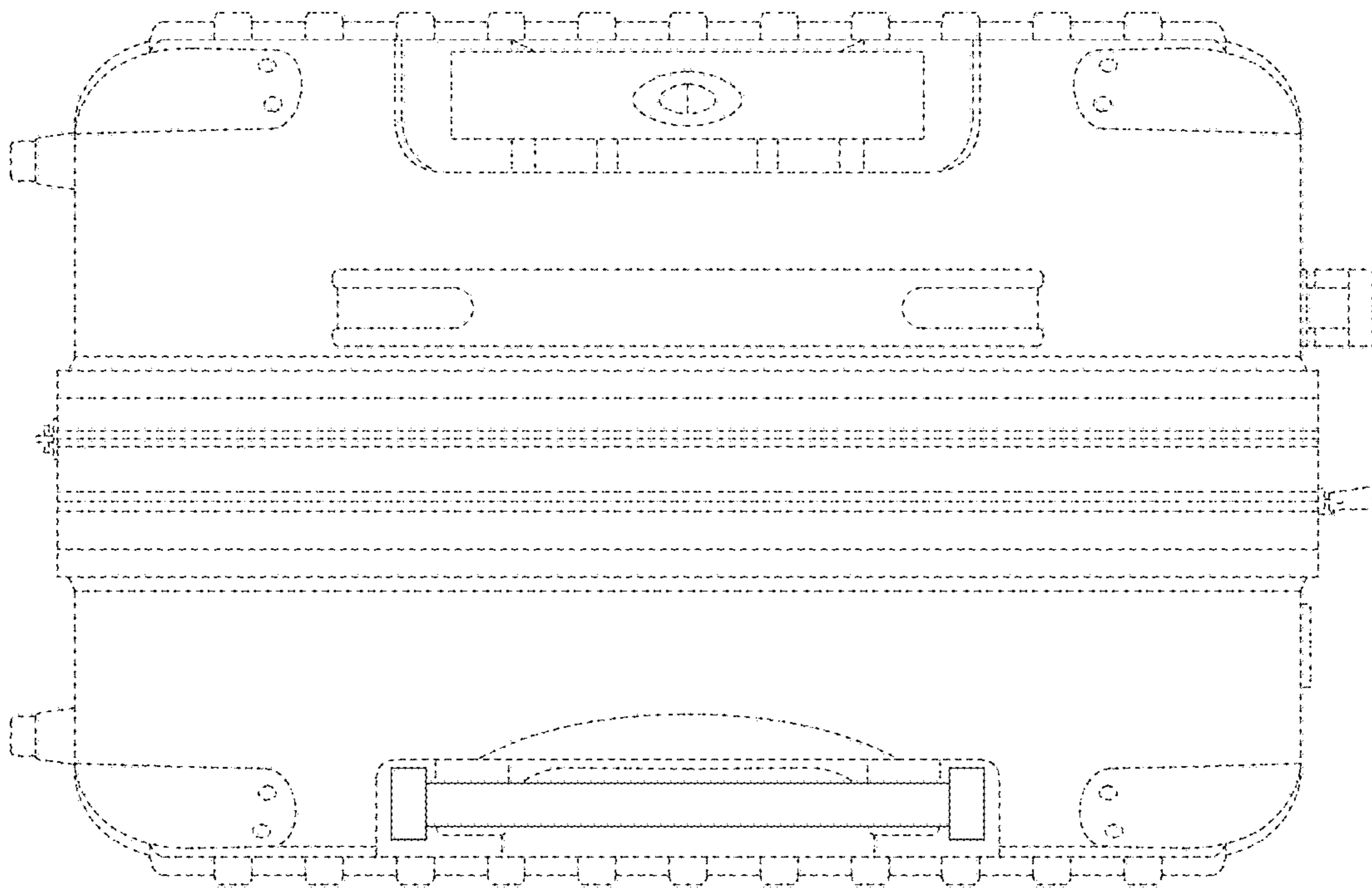

FIG. 4

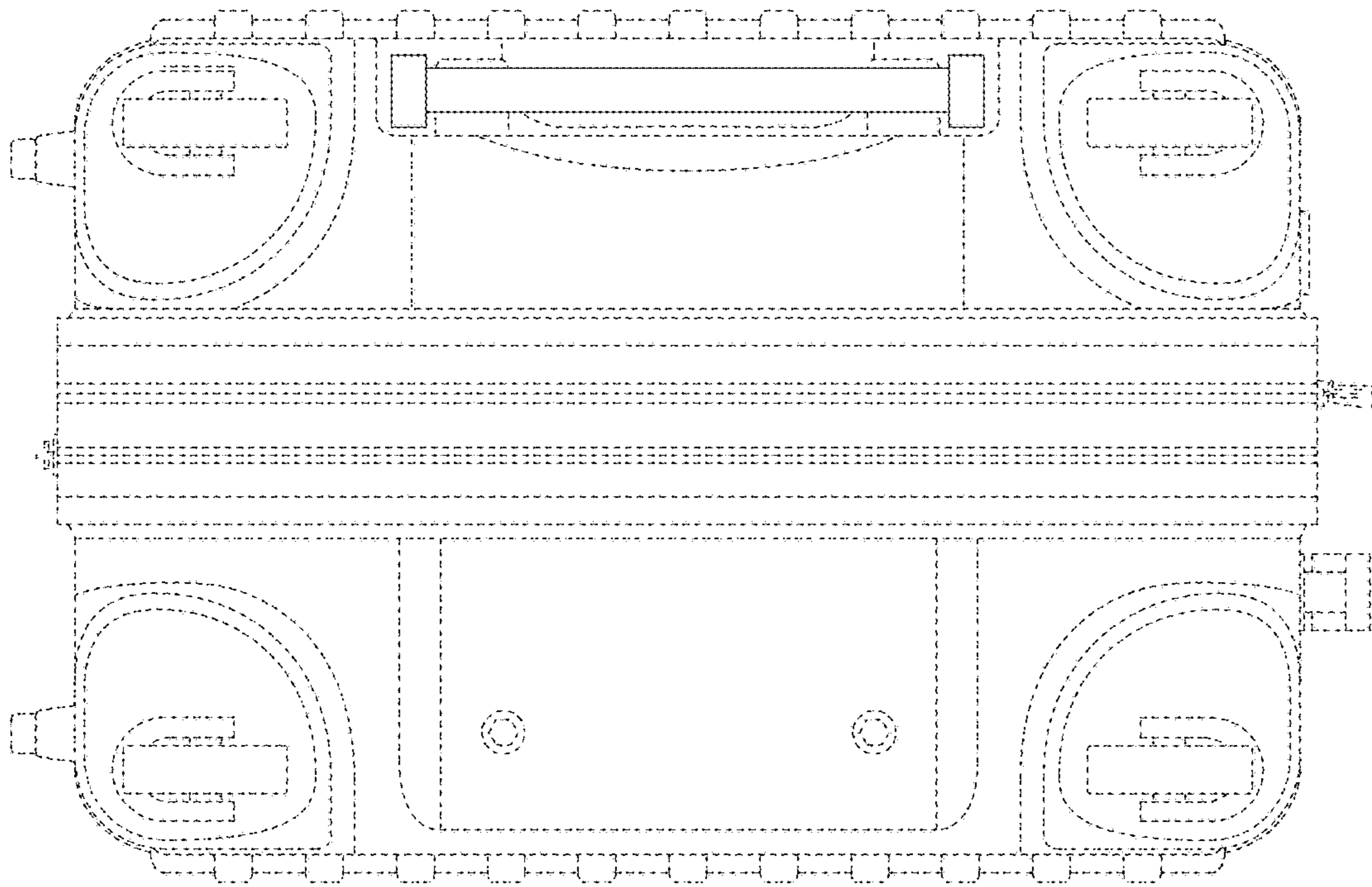

FIG. 5

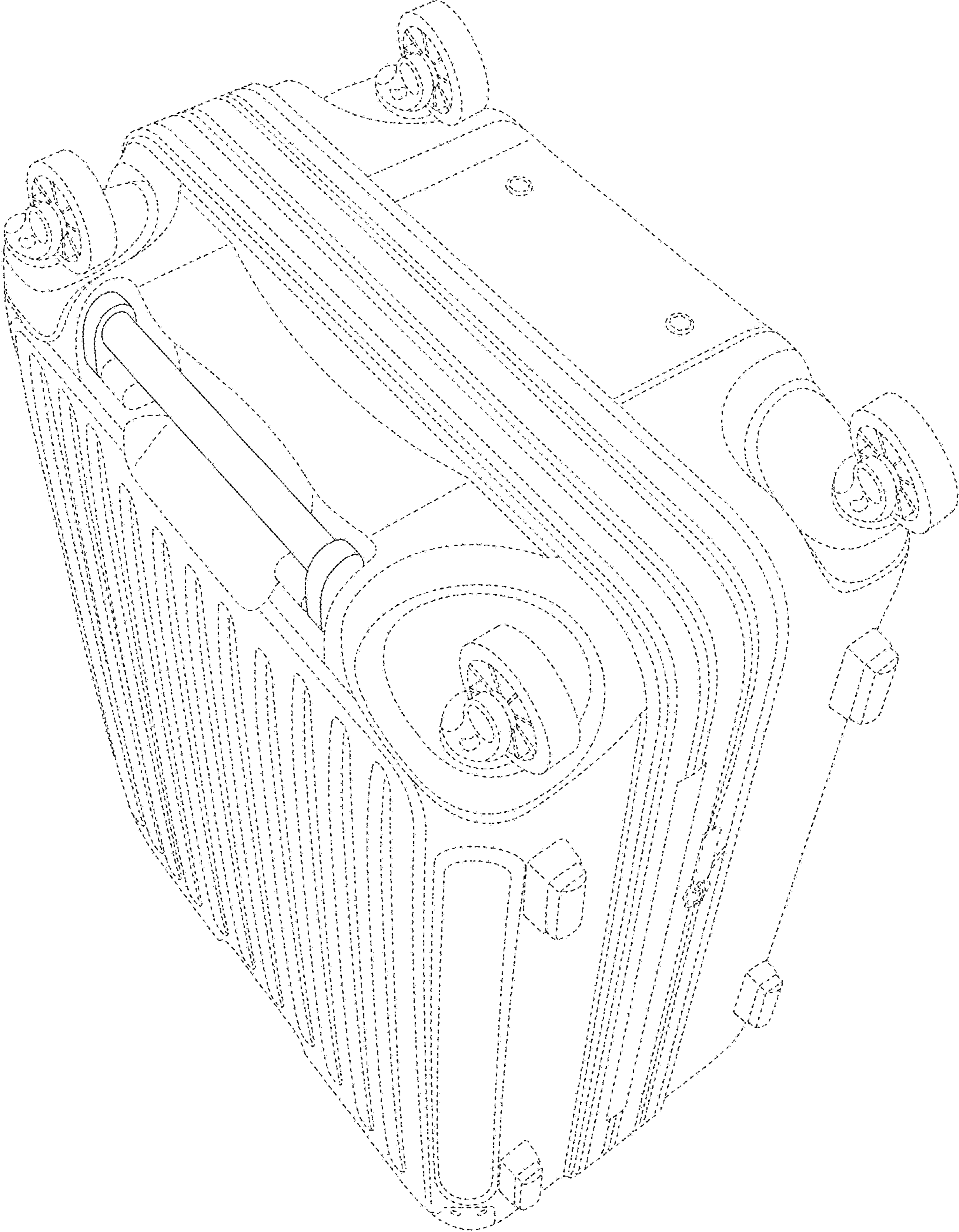

FIG. 6

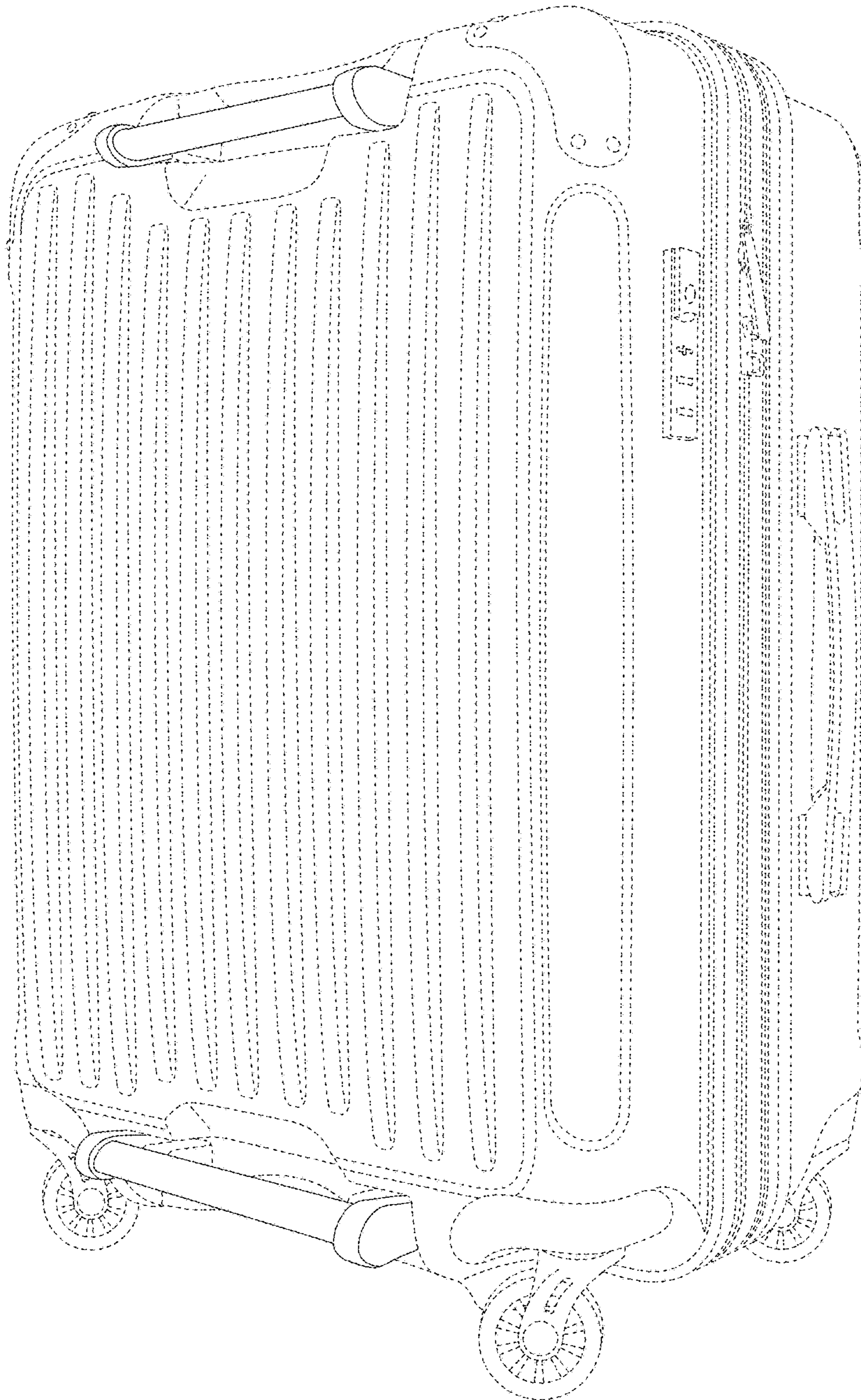



FIG. 7

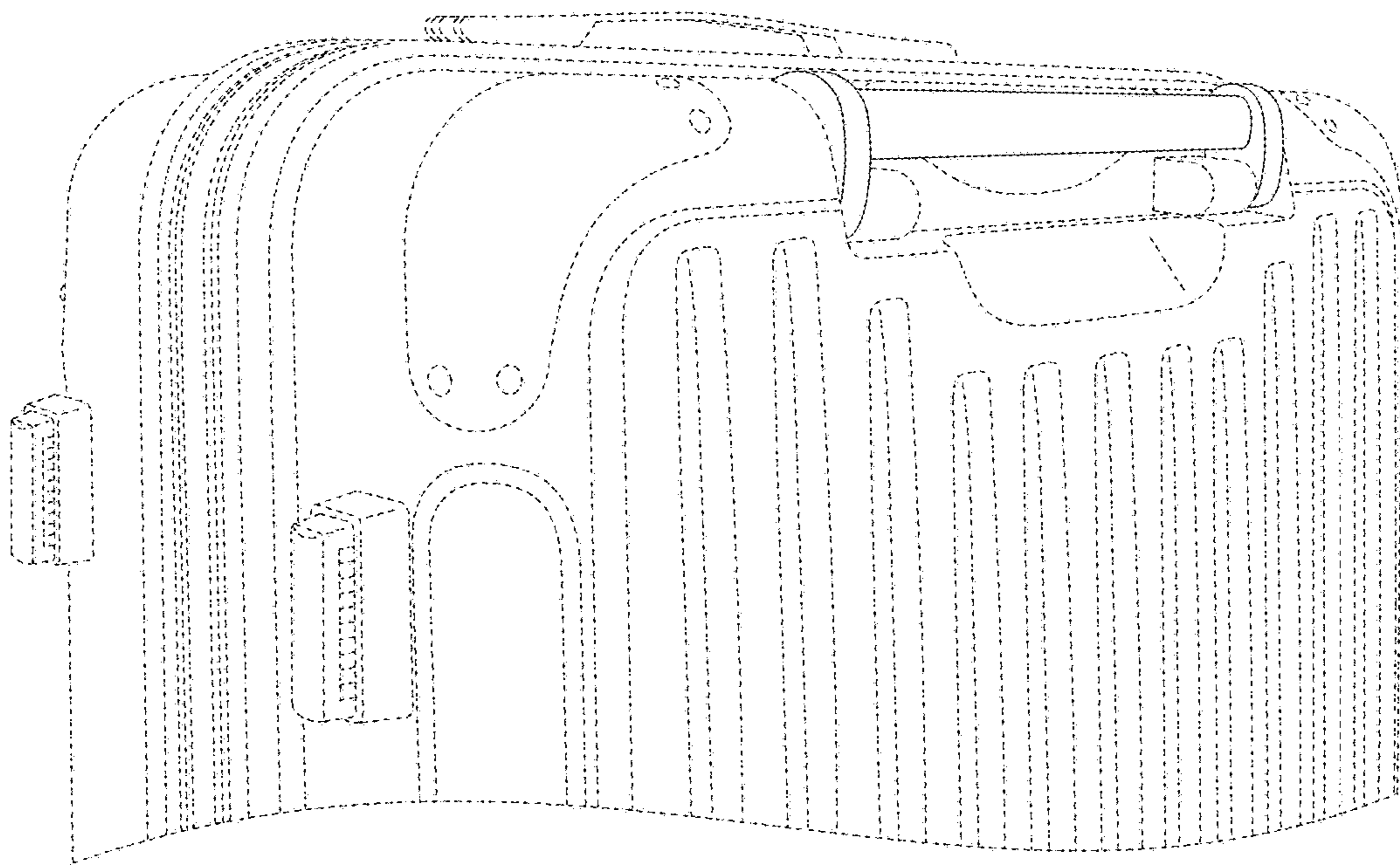

FIG. 8

