



US00D835408S

(12) **United States Design Patent** (10) **Patent No.:** **US D835,408 S**
Justiss (45) **Date of Patent:** **** Dec. 11, 2018**

(54) **SLEEVE WALLET WITH PULL TAB**

D741,598 S * 10/2015 Calero D3/303
D745,278 S * 12/2015 Gluck D3/300
D776,426 S * 1/2017 Smith D3/247

(71) Applicant: **Nate Justiss**, Charleston, SC (US)

* cited by examiner

(72) Inventor: **Nate Justiss**, Charleston, SC (US)

Primary Examiner — Holly H Baynham

(73) Assignee: **Distil Union, LLC**, Charleston, SC (US)

(74) *Attorney, Agent, or Firm* — Gregory Finch; Finch Paolino, LLC

(**) Term: **15 Years**

(57) **CLAIM**

The ornamental design for a sleeve wallet with pull tab, as shown and described.

(21) Appl. No.: **29/594,603**

DESCRIPTION

(22) Filed: **Feb. 21, 2017**

(51) **LOC (11) Cl.** **03-01**

(52) **U.S. Cl.**
USPC **D3/247; D3/300**

(58) **Field of Classification Search**
USPC D3/300, 303, 247, 249–253
CPC .. A45C 1/06; A45C 3/08; A45C 11/18; A45C 11/182

See application file for complete search history.

FIG. 1 is a front view of the sleeve wallet with pull tab embodying the present ornamental design with a representation of a contents in a front storage pocket;
FIG. 2 is front view thereof without contents in the front storage pocket;
FIG. 3 is a rear view thereof in a closed configuration;
FIG. 4 is rear view thereof with the pull tab deployed with a representation of a contents in a primary storage pocket;
FIG. 5 is a side view thereof;
FIG. 6 is an isometric top down view thereof with the spring steel opening of the primary storage compartment engaged in an open configuration;
FIG. 7 is a top down view thereof in a closed configuration; and,
FIG. 8 is a bottom up view thereof in a closed configuration. The dashed lines in FIGS. 1, 4, and 6 illustrate the contents of the storage compartments and form no part of the claimed design. The broken lines around the perimeter of the wallet in FIGS. 1-4 and 6 represent stitching, and are incorporated as part of the claimed design.

(56) **References Cited**

U.S. PATENT DOCUMENTS

D314,865 S * 2/1991 Tuisku D3/247
D411,765 S * 7/1999 Holihan D3/201
D431,719 S * 10/2000 Mucarquer D3/247
7,175,084 B2 * 2/2007 Mennecart A45C 11/182
235/380
8,181,789 B1 * 5/2012 Casella A45C 11/182
206/39.7
D739,143 S * 9/2015 Eskandry D3/303

1 Claim, 8 Drawing Sheets

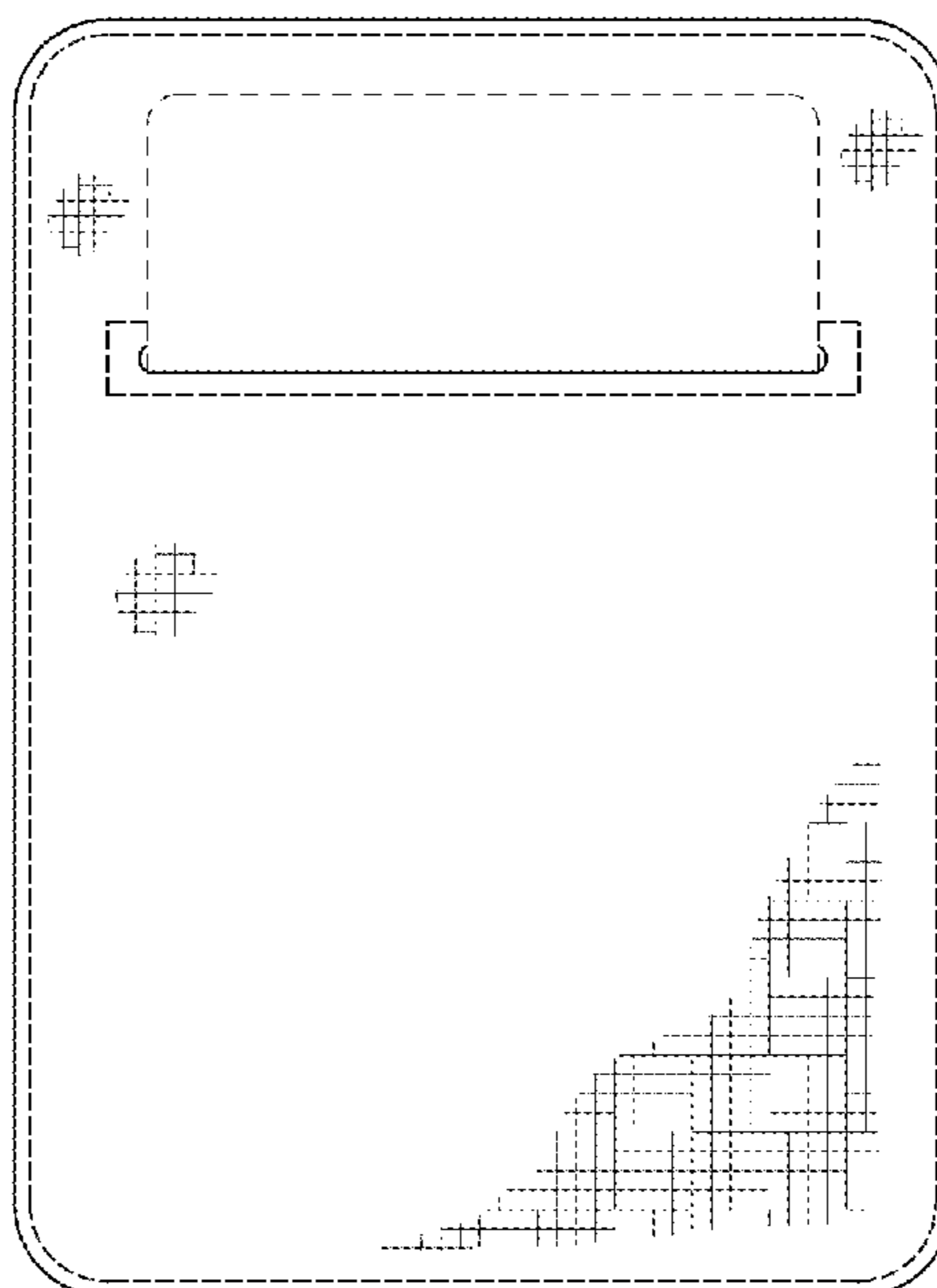

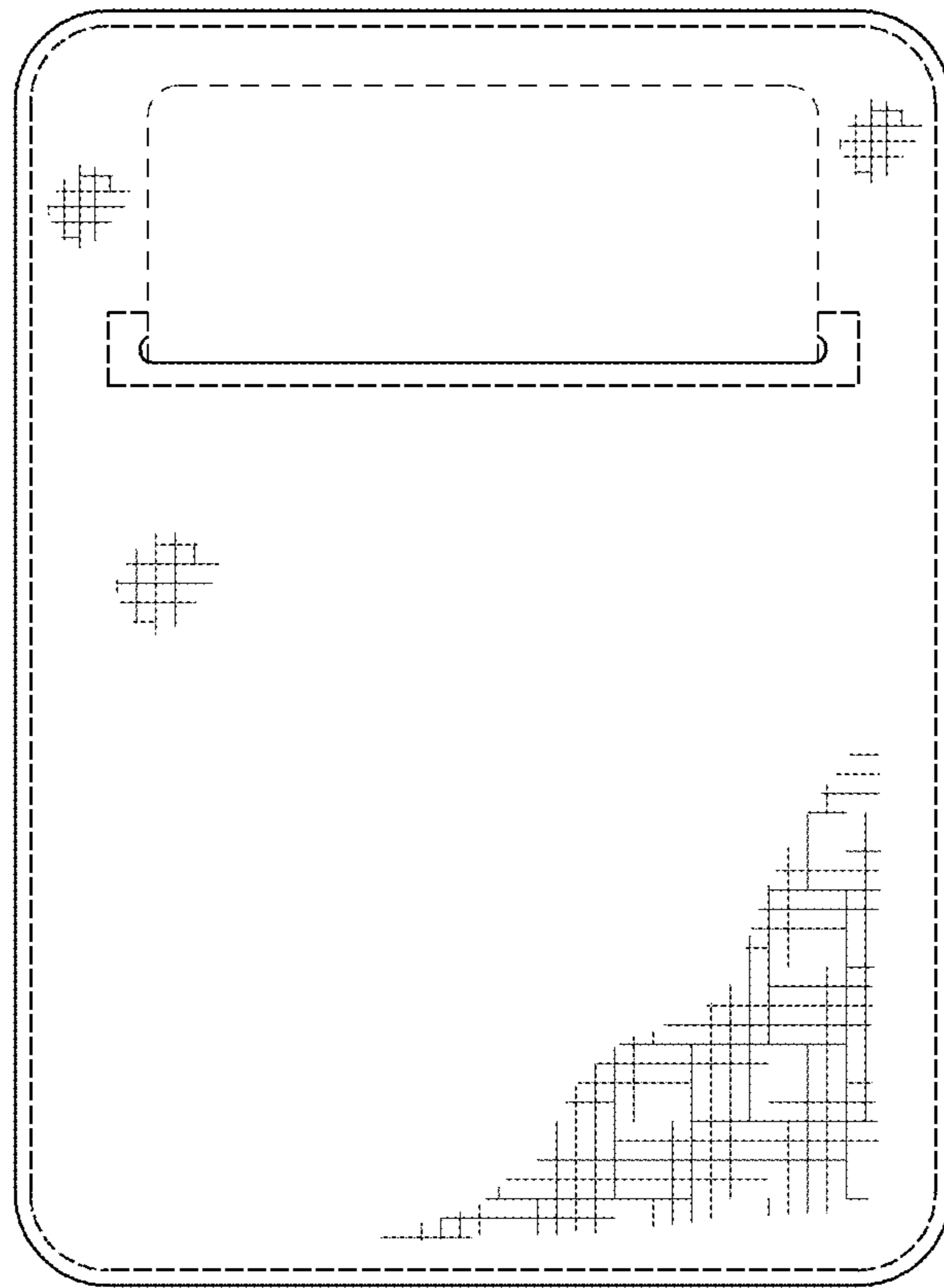

FIG. 1

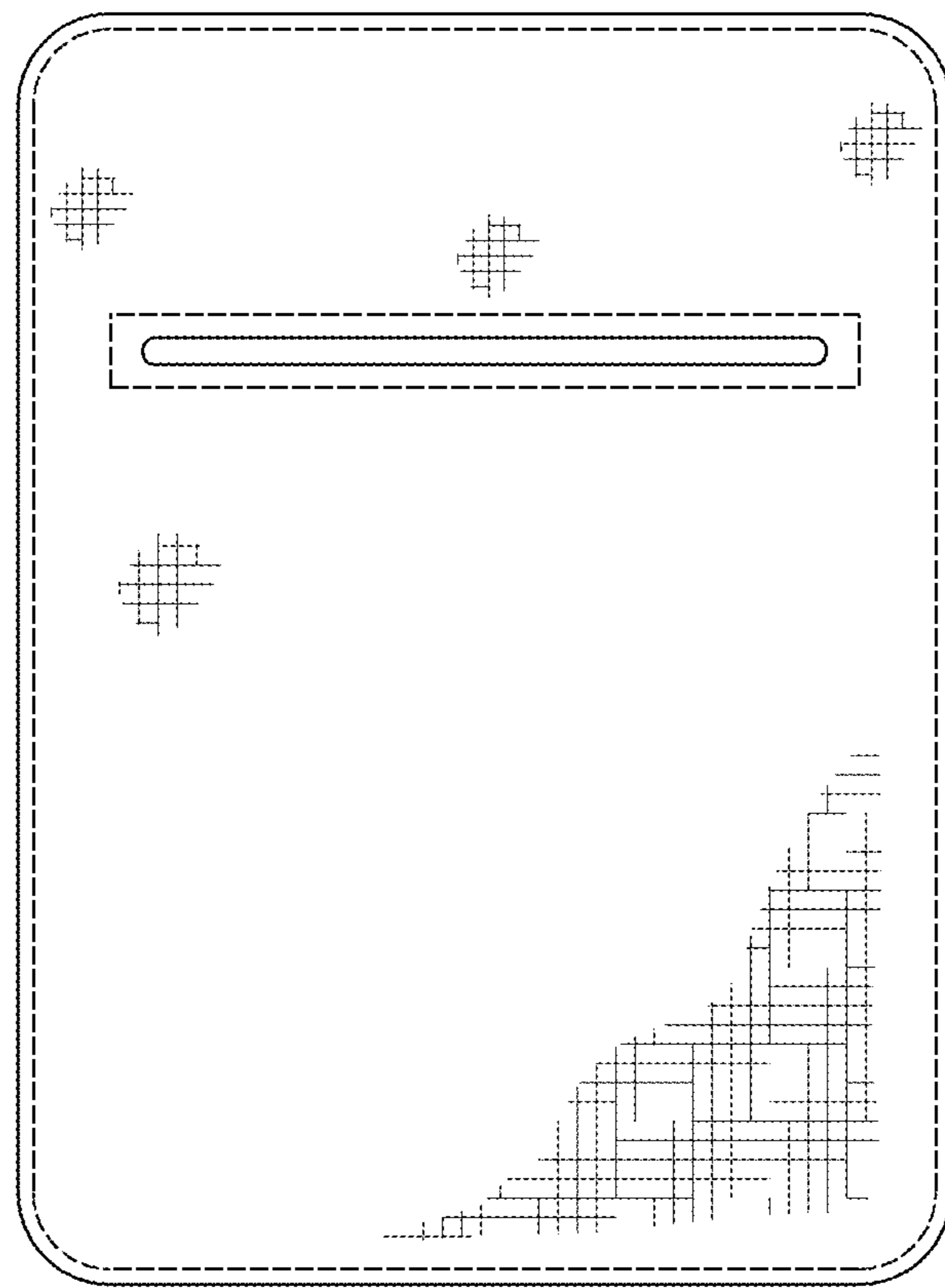

FIG. 2

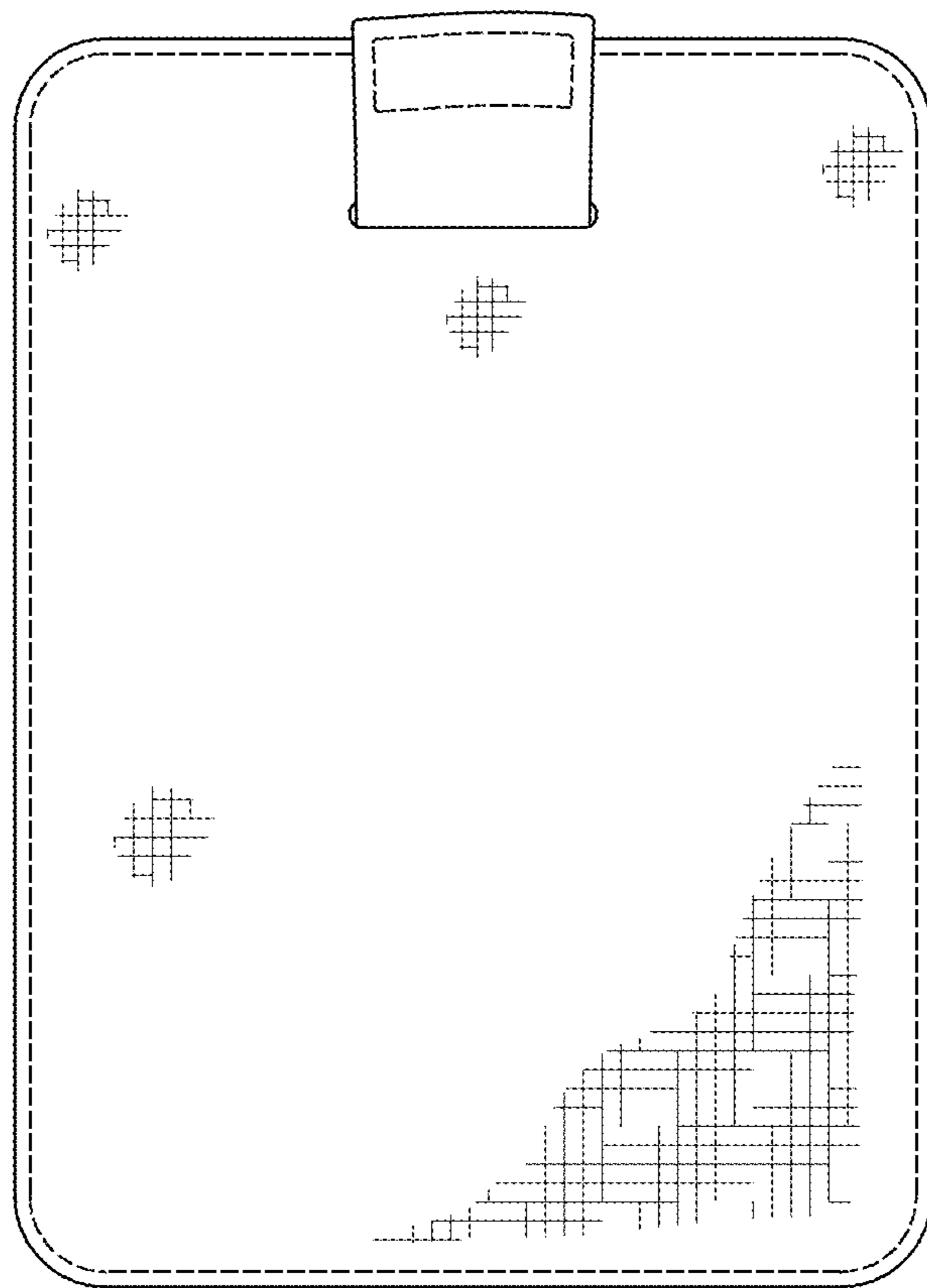

FIG. 3

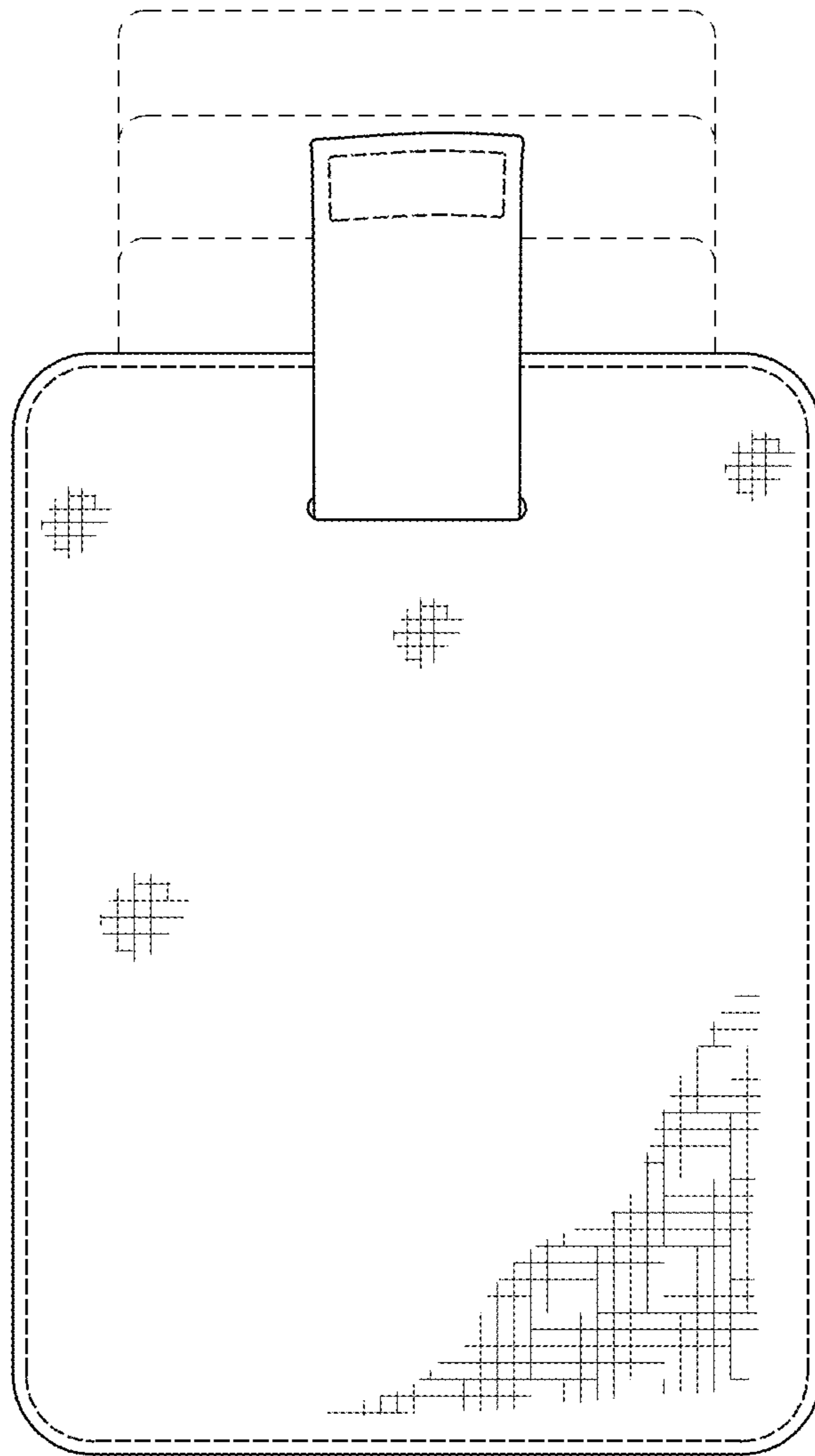

FIG. 4

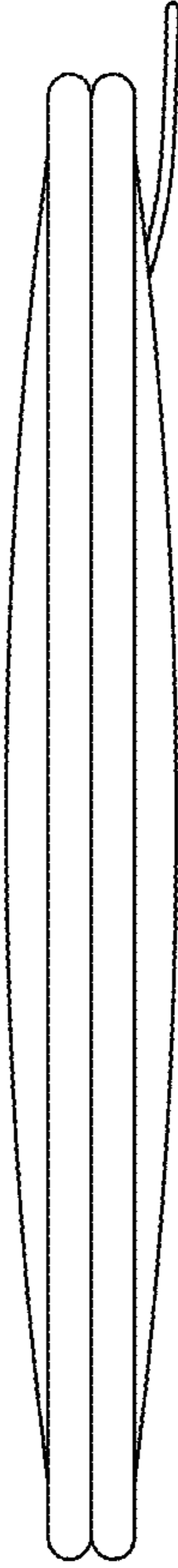

FIG. 5

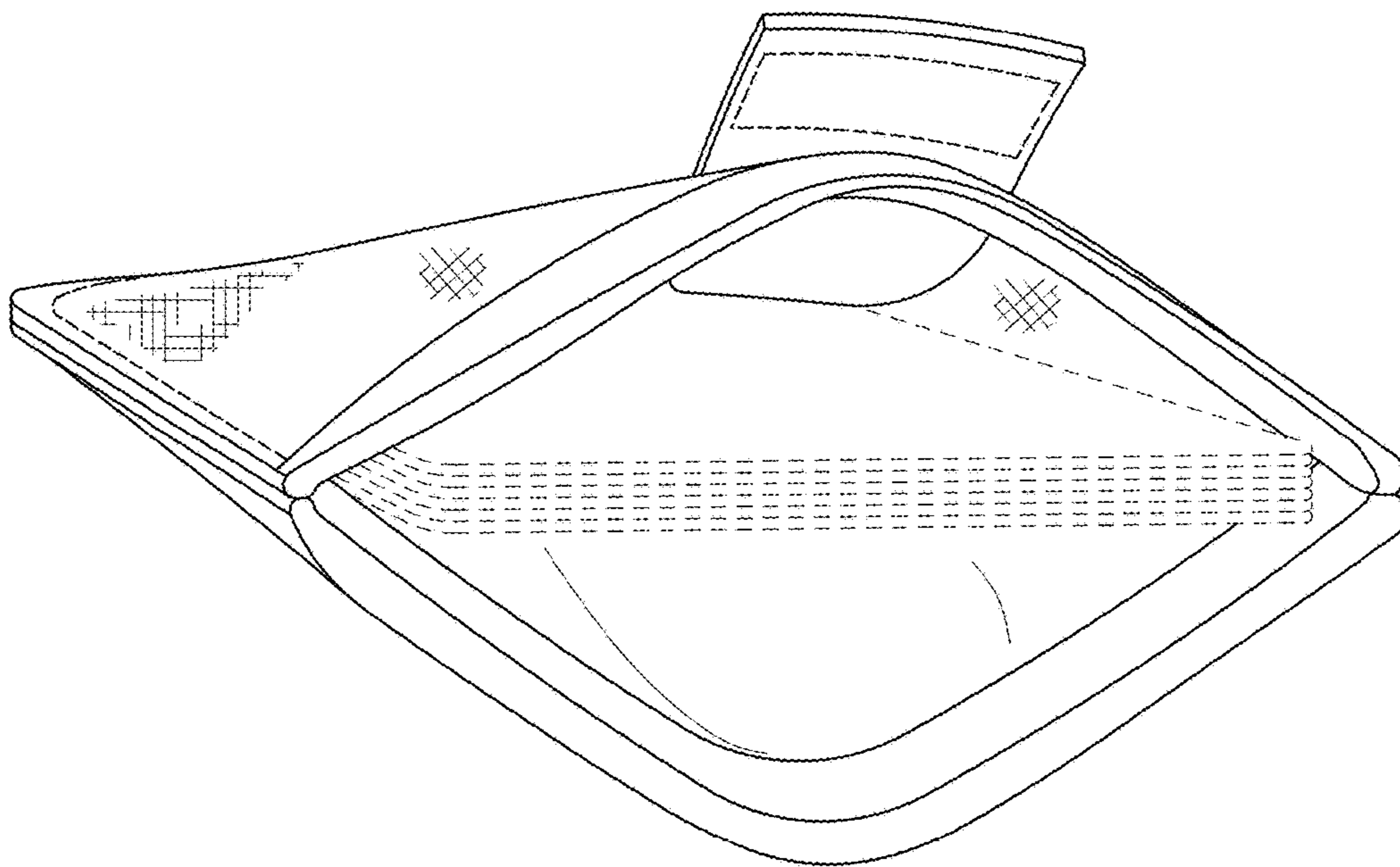

FIG. 6

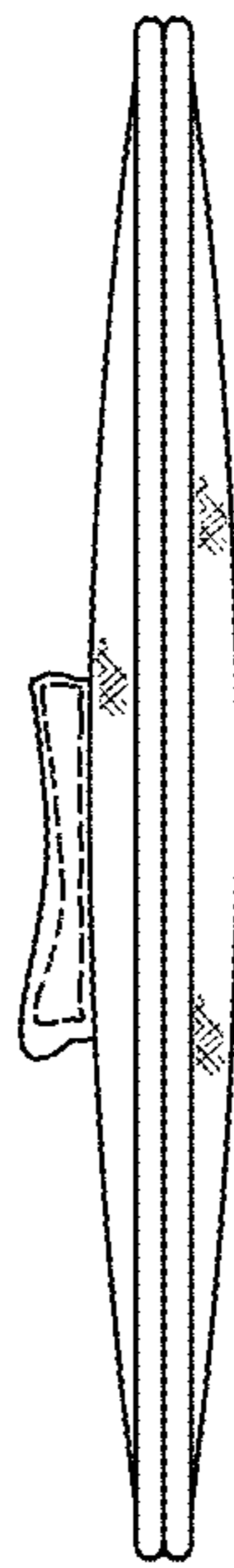

FIG. 7

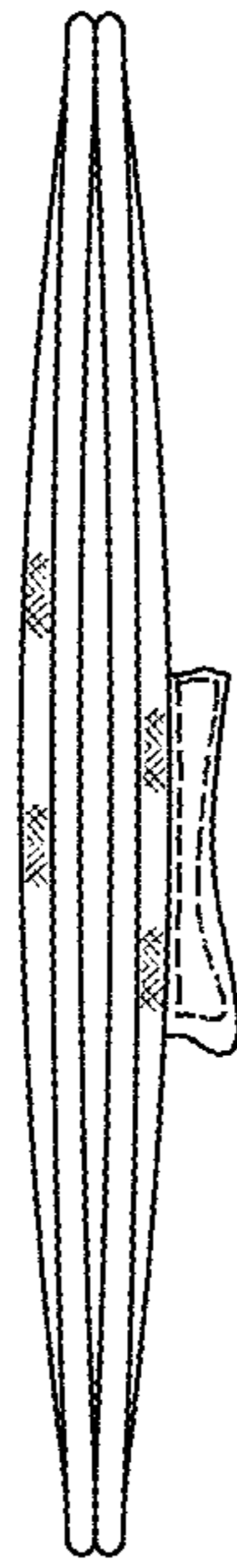

FIG. 8