



US00D835401S

(12) **United States Design Patent**
Greenberg

(10) **Patent No.:** **US D835,401 S**

(45) **Date of Patent:** **** Dec. 11, 2018**

(54) **DETACHABLE BAG**

(71) Applicant: **Miriam Greenberg**, Simsbury, CT
(US)

(72) Inventor: **Miriam Greenberg**, Simsbury, CT
(US)

(**) Term: **15 Years**

(21) Appl. No.: **29/596,933**

(22) Filed: **Mar. 13, 2017**

(51) **LOC (11) Cl.** **03-01**

(52) **U.S. Cl.**
USPC **D3/226**

(58) **Field of Classification Search**
USPC D3/203.1, 215, 217, 226, 233, 232, 273,
D3/274, 276, 283, 285, 289, 304, 305,
D3/902; D12/133

(Continued)

(56) **References Cited**

U.S. PATENT DOCUMENTS

D352,260 S * 11/1994 Adamo D12/133
D373,750 S * 9/1996 Gunderson D12/133

(Continued)

OTHER PUBLICATIONS

Amazon, "MINI Walker Bag for Cell Phone", Earliest review on
May 31, 2014. (<https://www.amazon.com/Walker-Phone-Senior-Accessory-Green/dp/B00H39HACW?th=1>).*

(Continued)

Primary Examiner — Jennifer Rivard

Assistant Examiner — April Rivas

(74) *Attorney, Agent, or Firm* — Cantor Colburn LLP

(57) **CLAIM**

I claim, the ornamental design for a detachable bag, as
shown and described.

DESCRIPTION

FIG. 1 is a front perspective view of a first embodiment of
a detachable bag, showing my new design;

FIG. 2 is a rear perspective view of the embodiment shown
in FIG. 1;

FIG. 3 is a front plan view of the embodiment shown in FIG.
1;

FIG. 4 is a rear plan view of the embodiment shown in FIG.
1;

FIG. 5 is a right side elevation view of the embodiment
shown in FIG. 1;

FIG. 6 is a left side elevation view of the embodiment shown
in FIG. 1;

FIG. 7 is a bottom side elevation view of the embodiment
shown in FIG. 1;

FIG. 8 is a top side elevation view of the embodiment shown
in FIG. 1

FIG. 9 is a front perspective view of the embodiment shown
in FIG. 1, as positioned in another configuration;

FIG. 10 is a front plan view of the configuration shown in
FIG. 9;

FIG. 11 is a right side elevation view of the configuration
shown in FIG. 9;

FIG. 12 is a front perspective view of a second embodiment
of a detachable bag, showing my new design;

FIG. 13 is a rear perspective view of the embodiment shown
in FIG. 12;

FIG. 14 is a front side plan view of the embodiment shown
in FIG. 12;

FIG. 15 is a rear side plan view of the embodiment shown
in FIG. 12;

FIG. 16 is a right side elevation view of the embodiment
shown in FIG. 12;

FIG. 17 is a left side elevation view of the embodiment
shown in FIG. 12;

FIG. 18 is a bottom side elevation view of the embodiment
shown in FIG. 12;

FIG. 19 is a top side elevation view of the embodiment
shown in FIG. 12;

FIG. 20 is a front perspective view of the embodiment shown
in FIG. 12, as positioned in another configuration;

FIG. 21 is a front plan view of the configuration shown in
FIG. 20; and,

FIG. 22 is a right side elevation view of the configuration
shown in FIG. 20.

The dash-dot lines illustrate a boundary and form no part of
the claimed design.

(Continued)

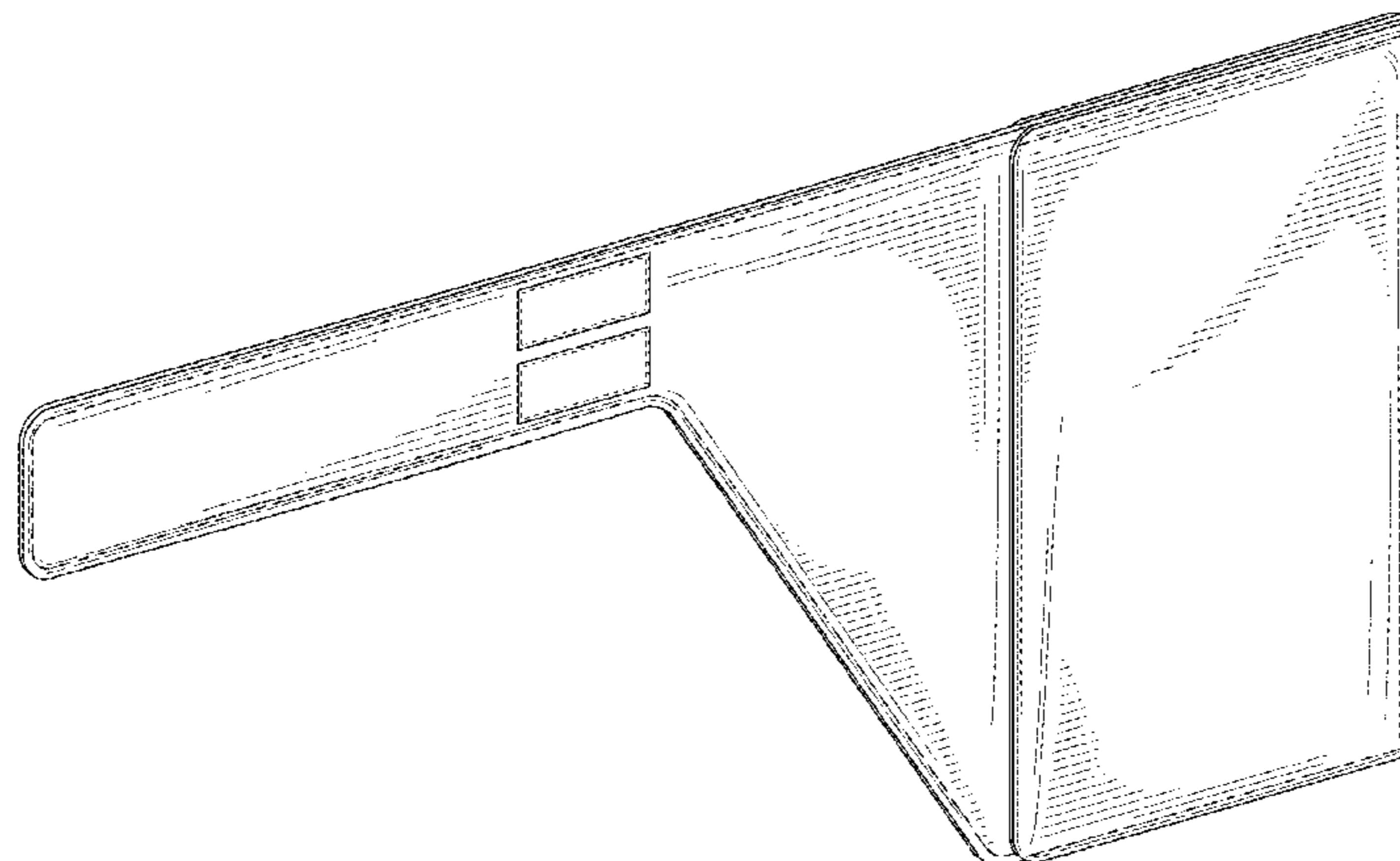

The broken lines illustrate portions of the detachable bag and form no part of the claimed design.

1 Claim, 18 Drawing Sheets

(58) **Field of Classification Search**

CPC B65D 21/084; A45C 7/009; A45C 7/0036;
A45C 7/0081; A45C 2003/008; A45C
3/00; A45C 5/005; A45C 7/0059

See application file for complete search history.

(56)

References Cited

U.S. PATENT DOCUMENTS

D391,075 S * 2/1998 Jackson D3/215
D459,875 S * 7/2002 Mack D3/226

D477,256 S * 7/2003 Mills D12/133
D622,058 S * 8/2010 Wagner, II D3/226
D623,852 S * 9/2010 Kroll D3/226
D656,071 S * 3/2012 Treon D12/133
D721,227 S * 1/2015 Milligan D3/221
D726,406 S * 4/2015 Orthwein D3/226
D732,818 S * 6/2015 Pineda D3/215
D790,722 S * 6/2017 Tyler D24/207
D791,474 S * 7/2017 Willis D3/226
D793,714 S * 8/2017 Zhou D3/203.1
D797,441 S * 9/2017 Sokolowski D3/215
D802,915 S * 11/2017 Willows D3/226

OTHER PUBLICATIONS

Etsy, "Wheelchair Arm Rest Cell Phone Holder Pocket . . ." by user WarriorAngelCreation, Accessed Dec. 20, 2017. (<https://www.etsy.com/listing/494258380/wheelchair-arm-rest-cell-phone-holder>).*

* cited by examiner

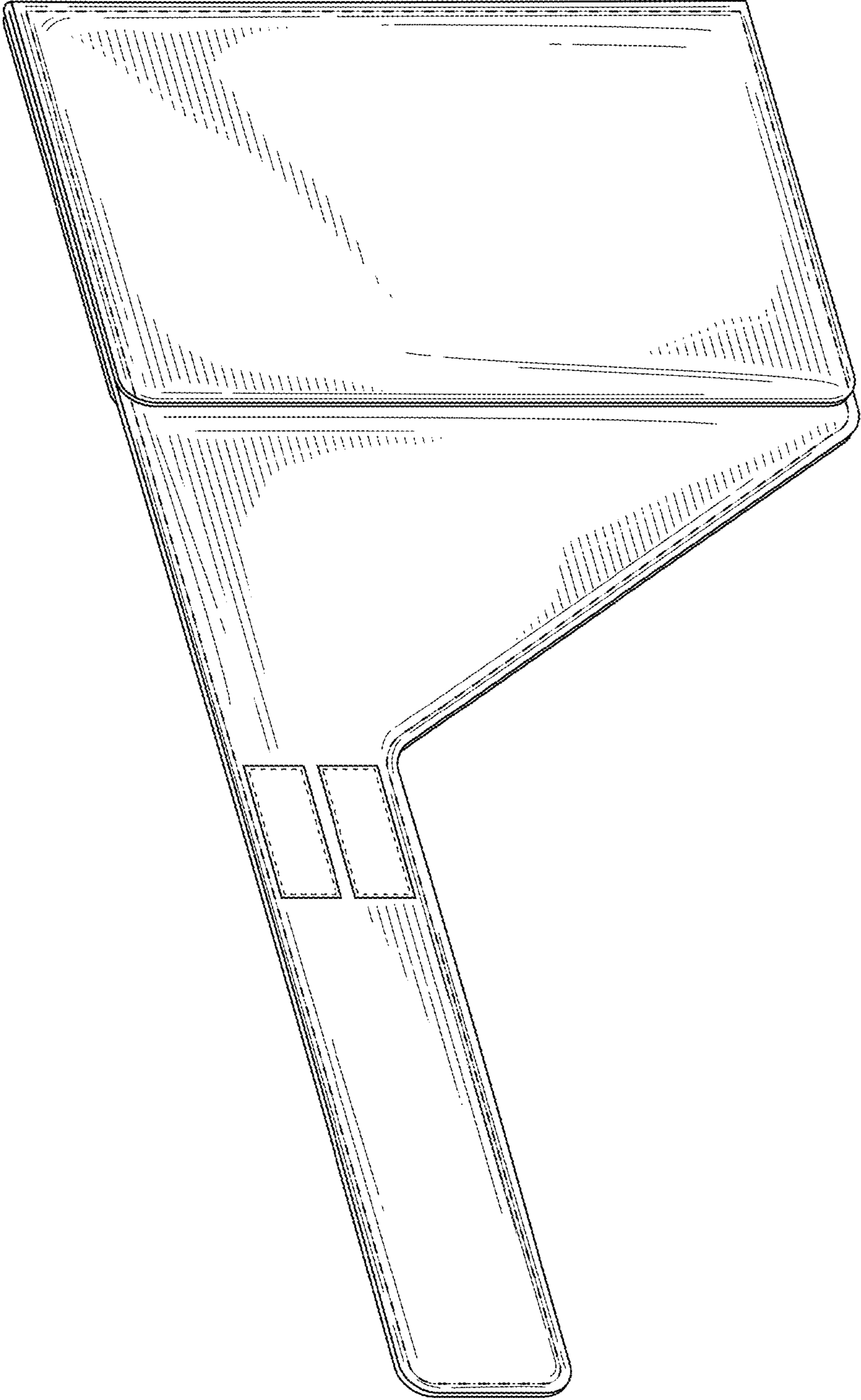

FIG. 1

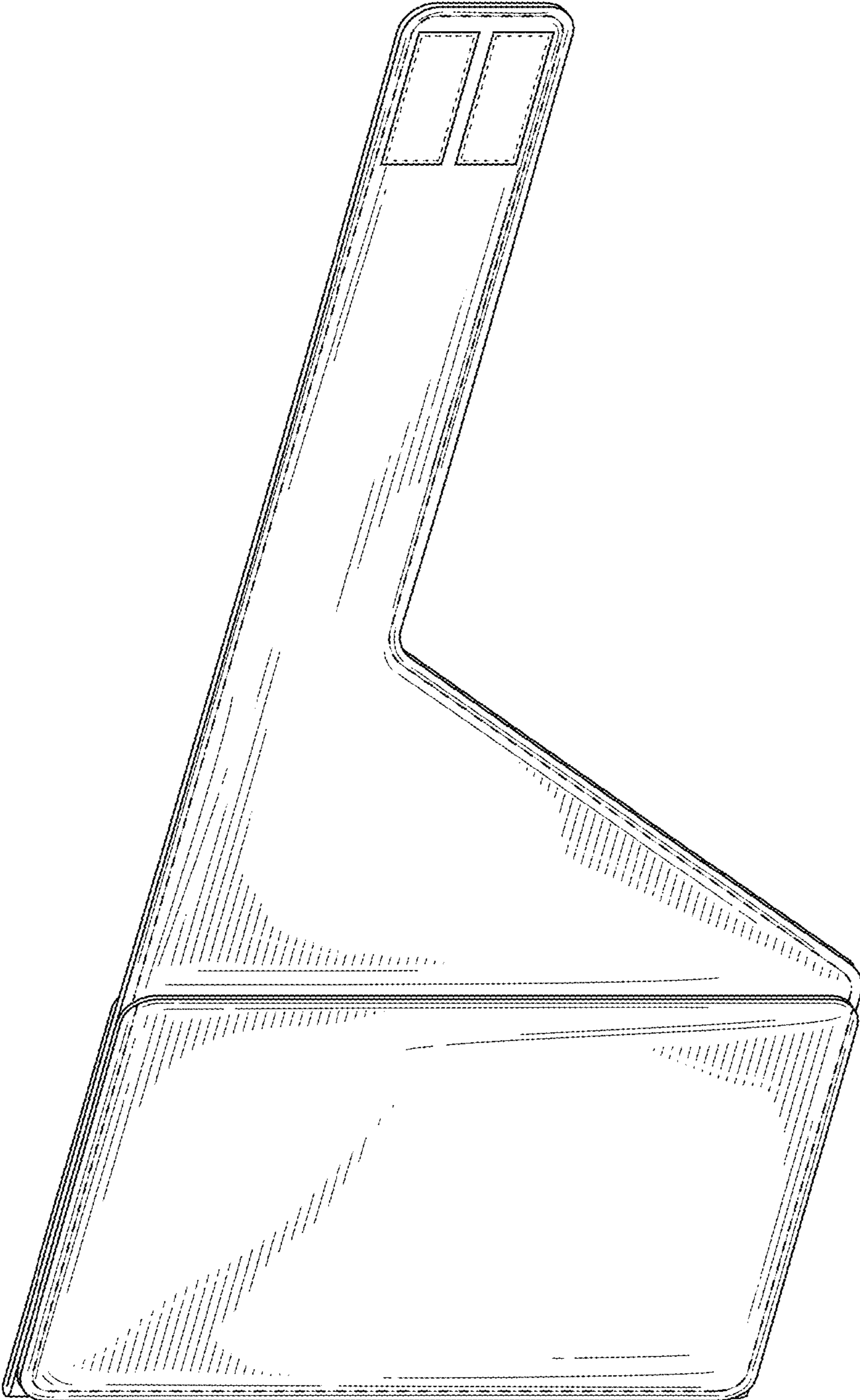

FIG. 2

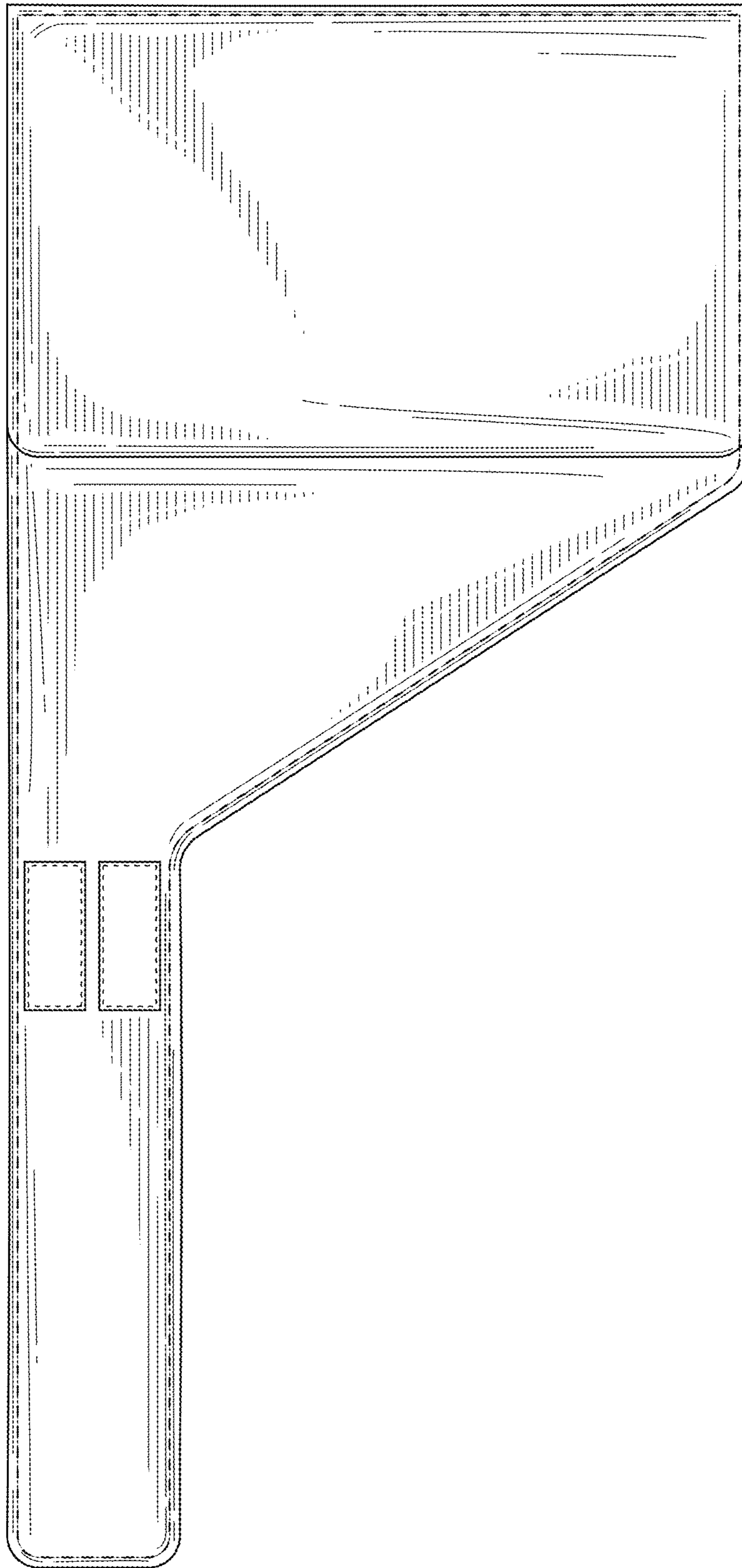

FIG. 3

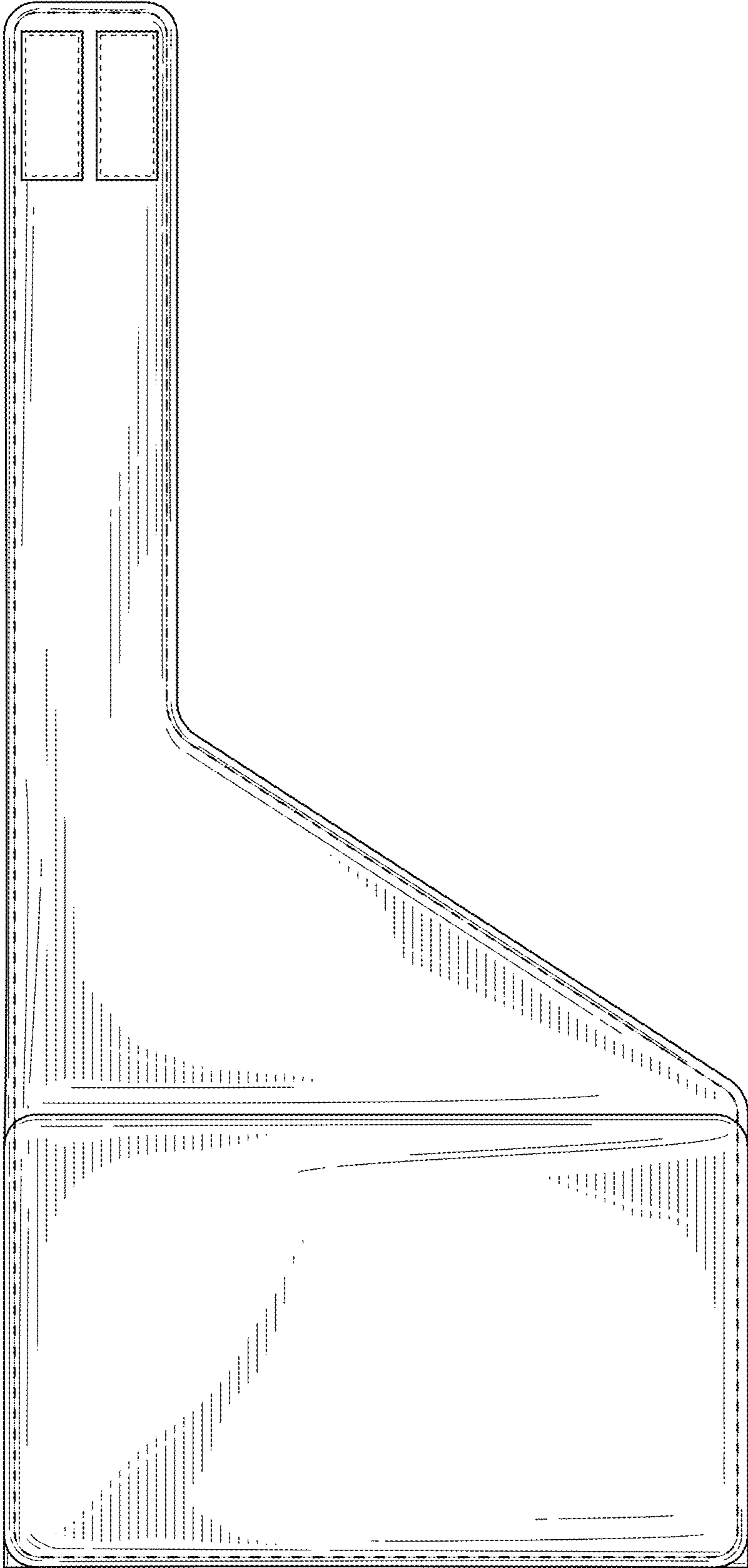

FIG. 4

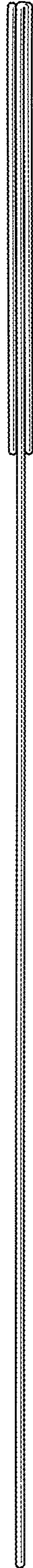

FIG. 5



FIG. 6

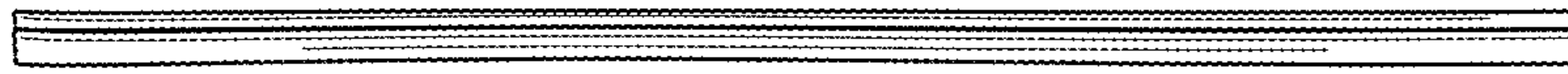

FIG. 8

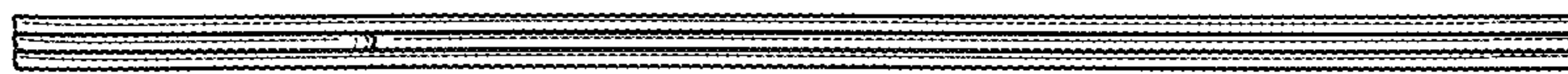

FIG. 7

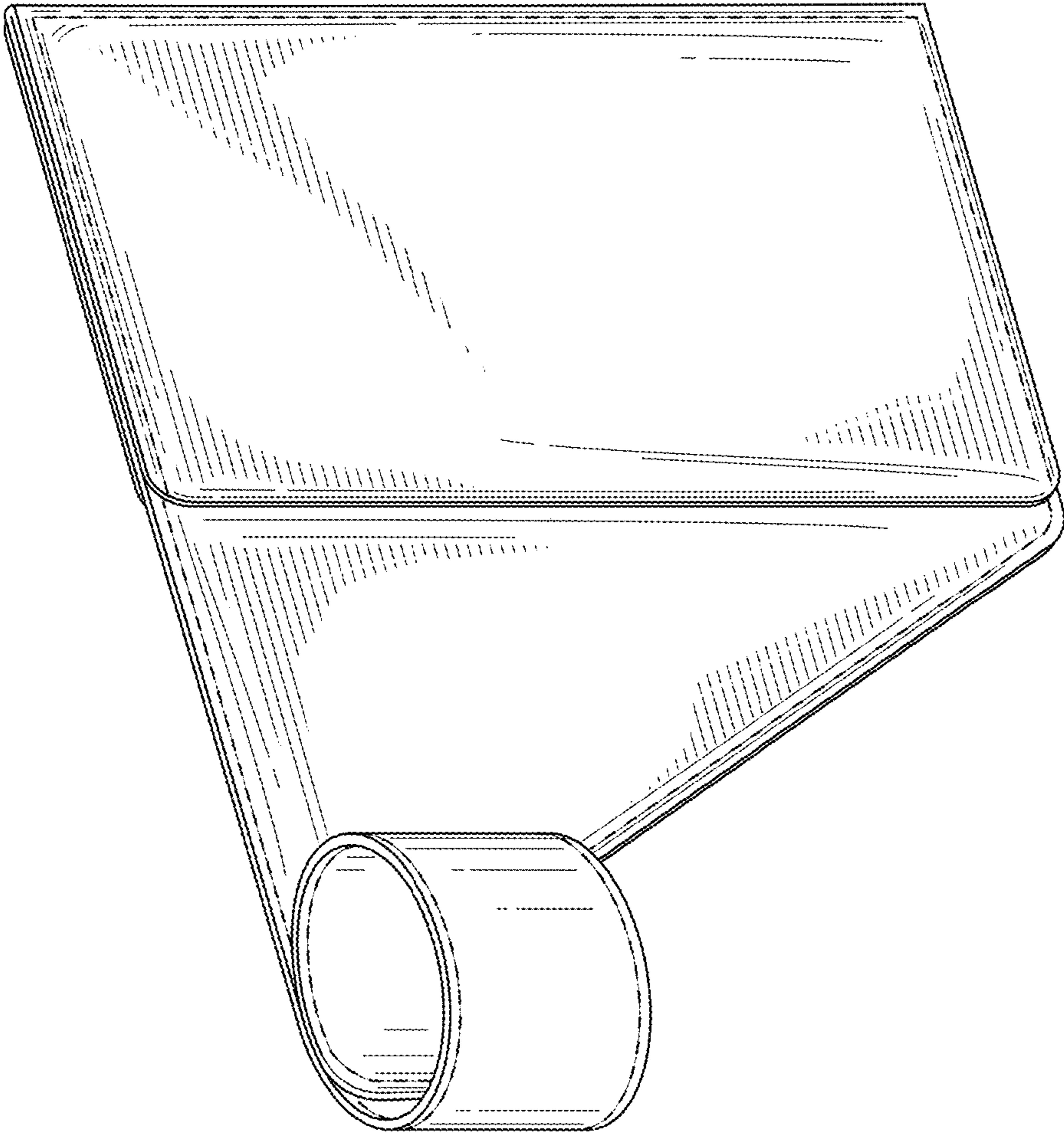

FIG. 9

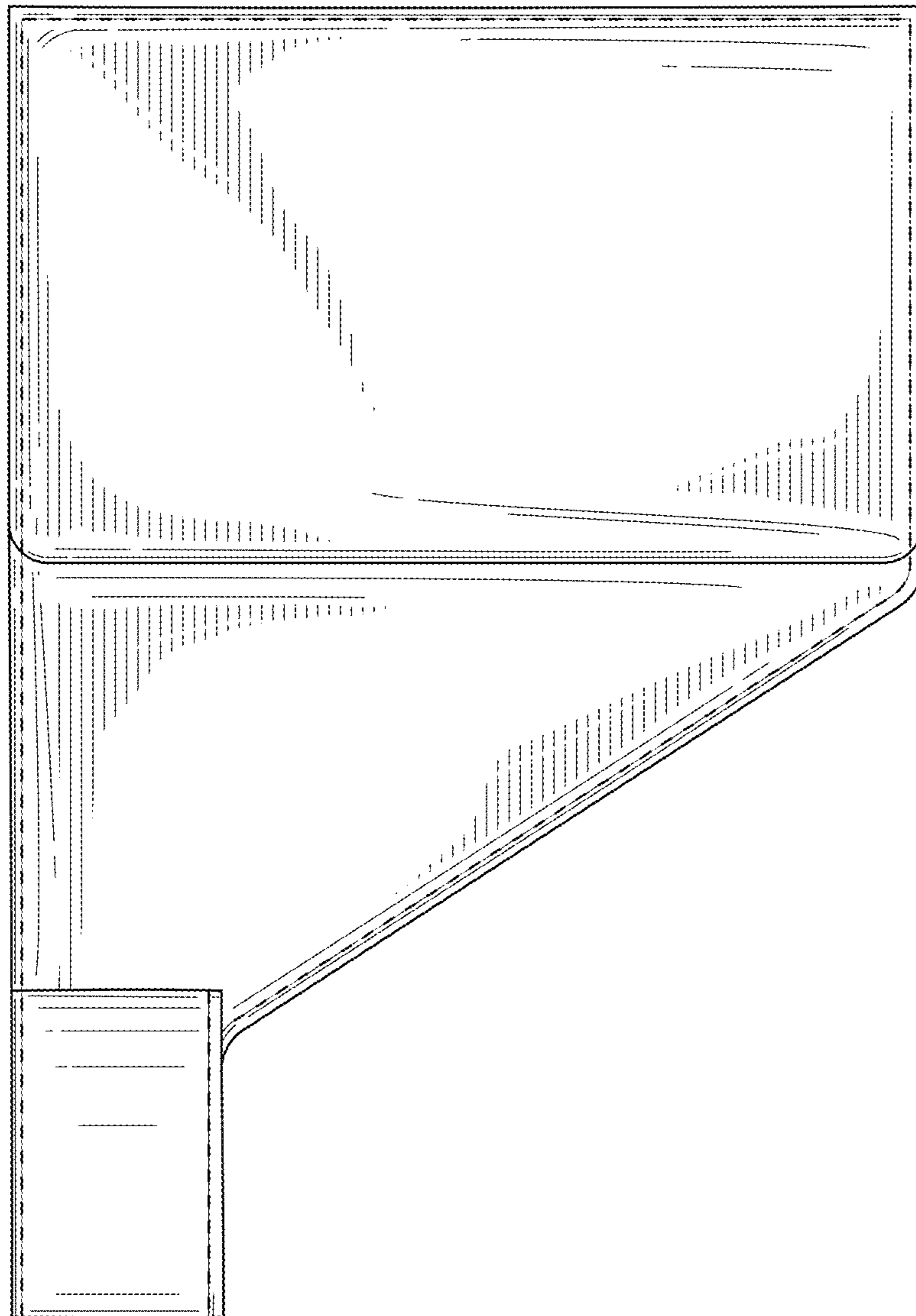

FIG. 10

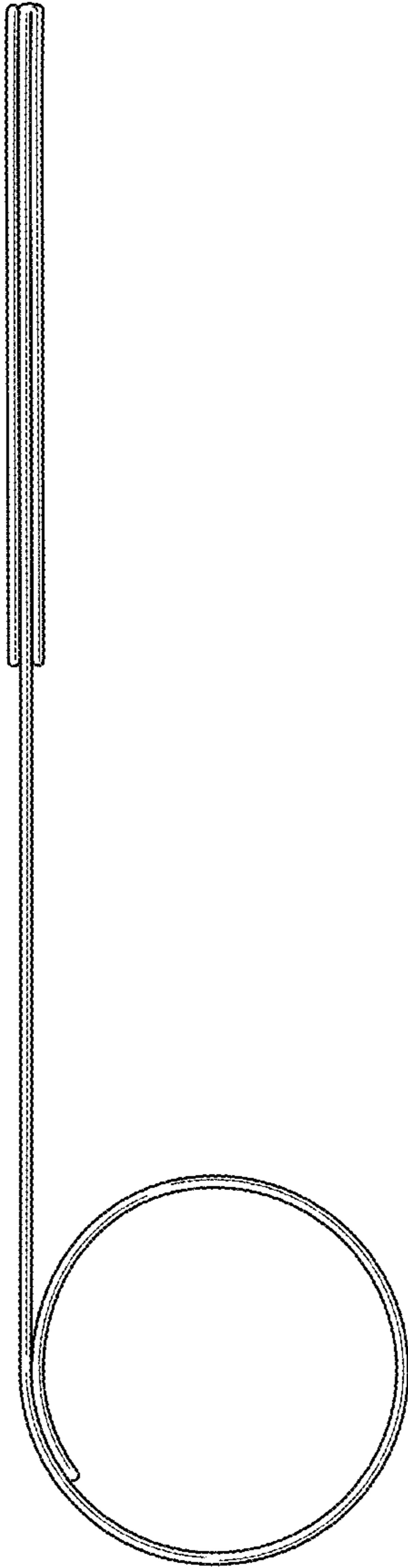

FIG. 11

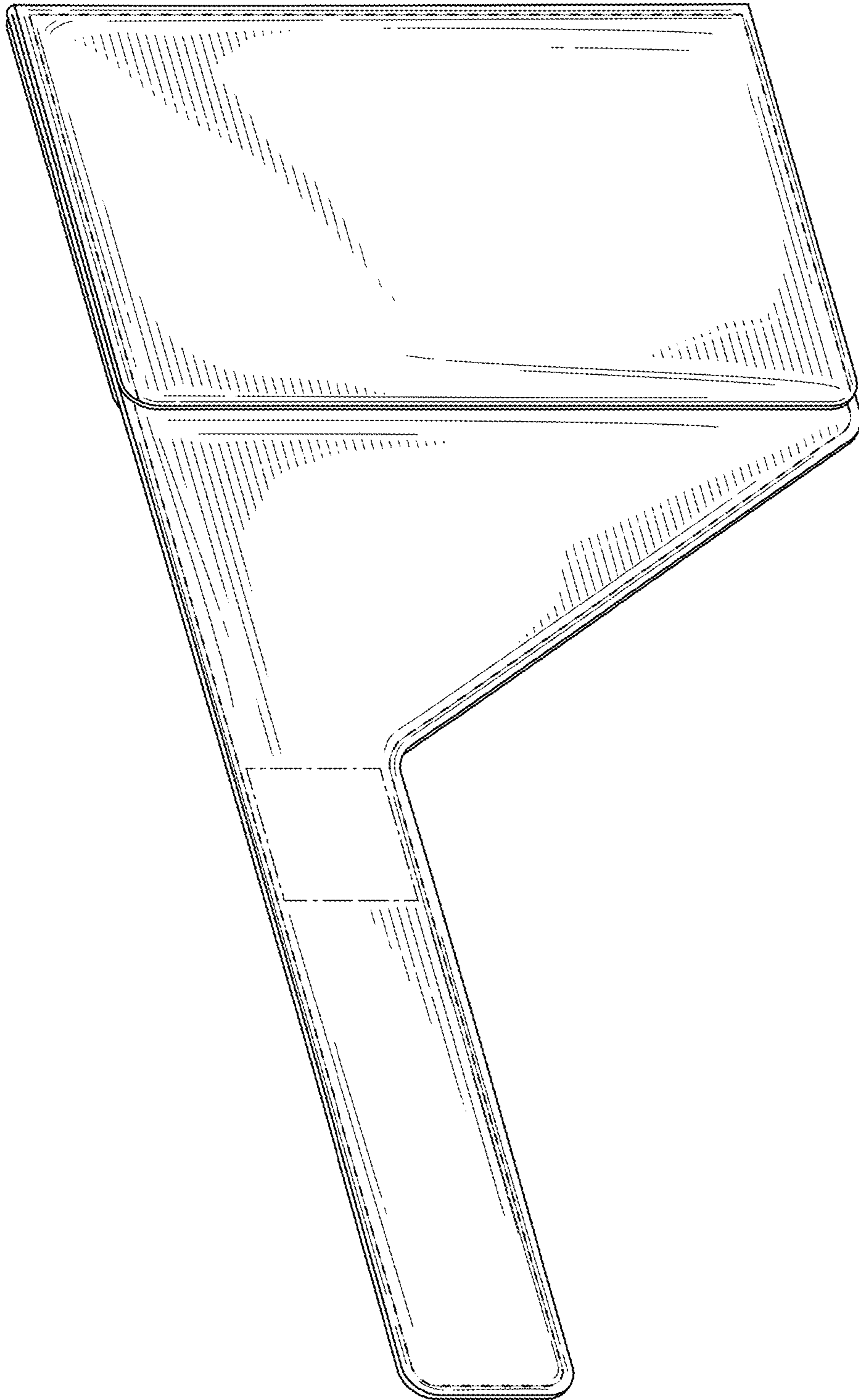

FIG. 12

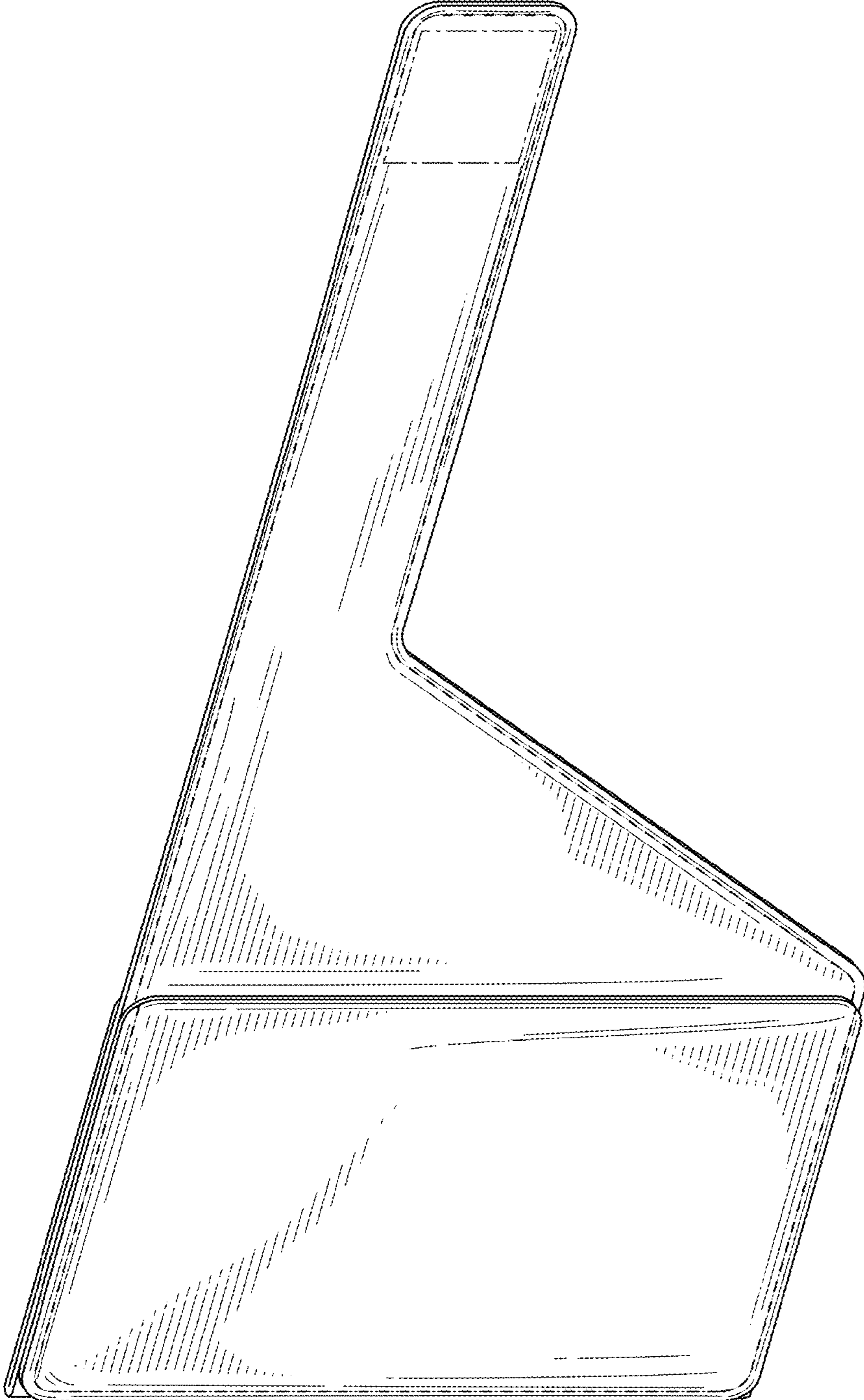

FIG. 13

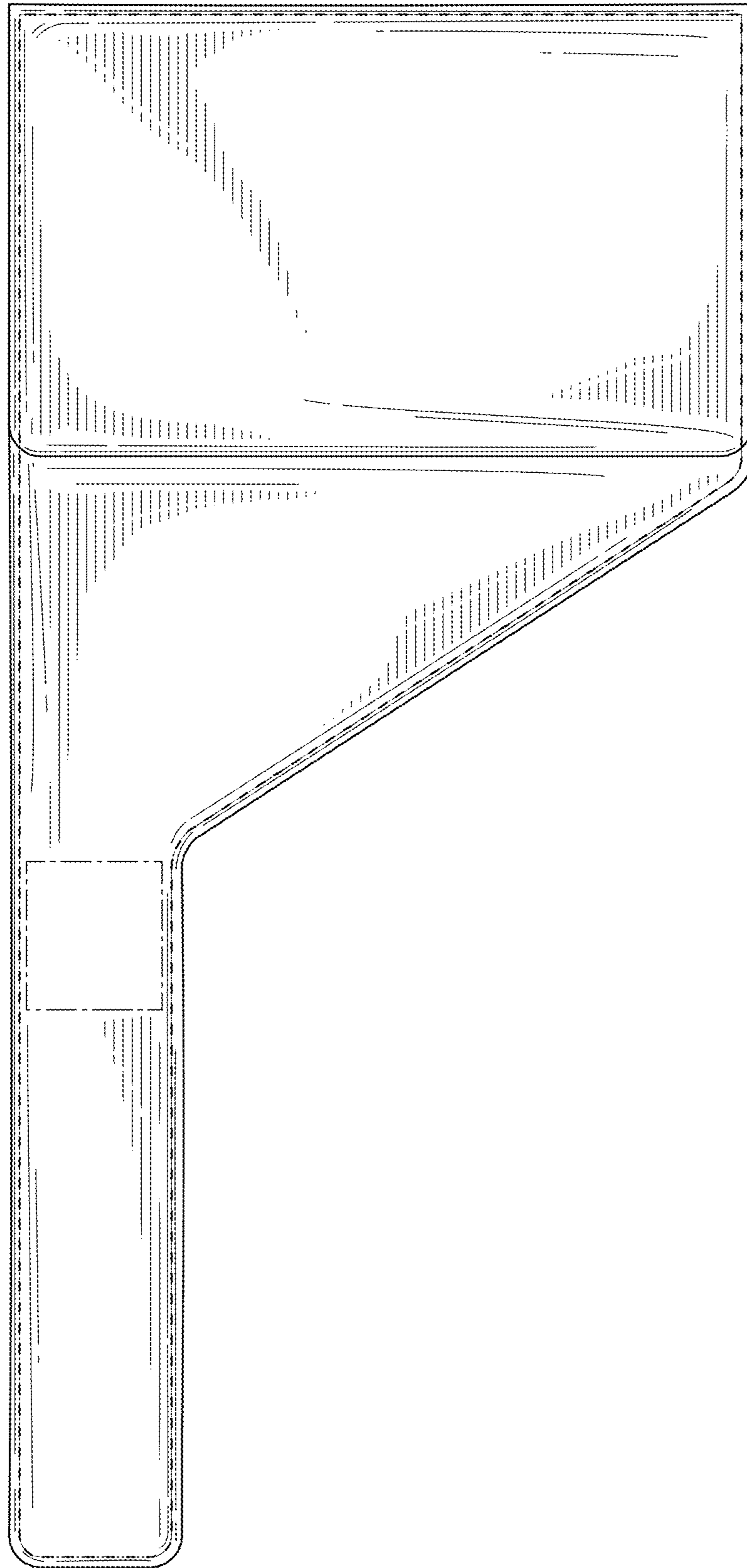

FIG. 14

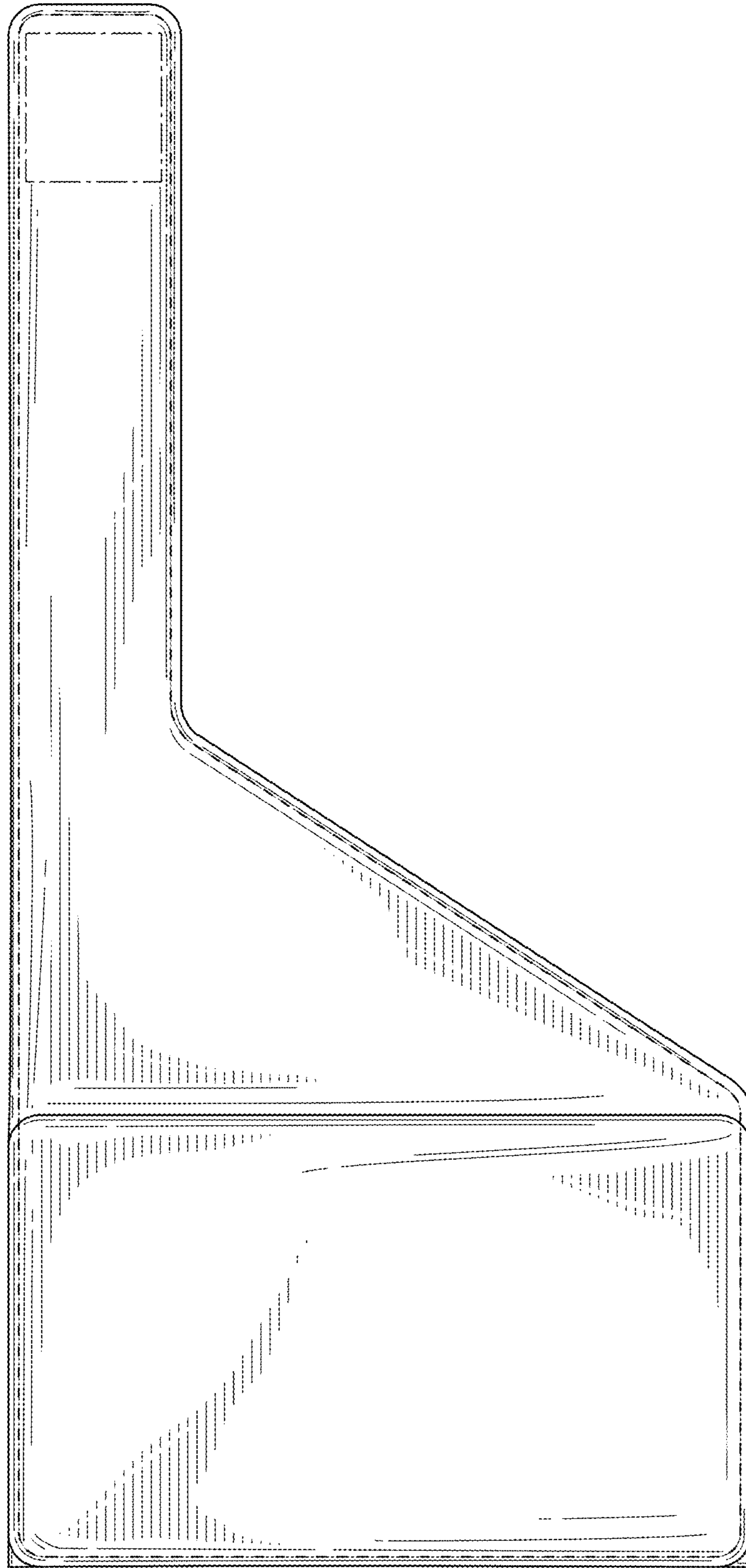

FIG. 15

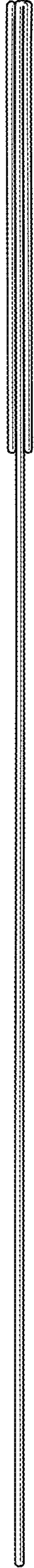

FIG. 16

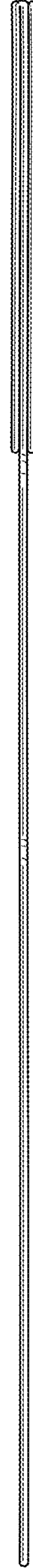

FIG. 17

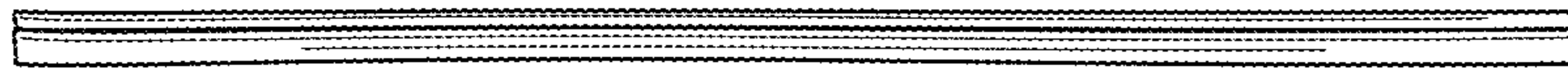

FIG. 79

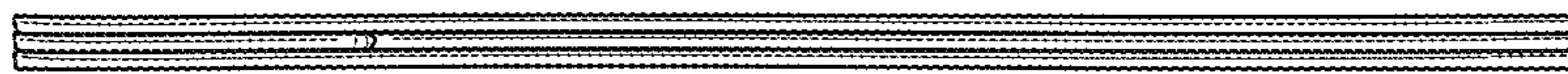

FIG. 78

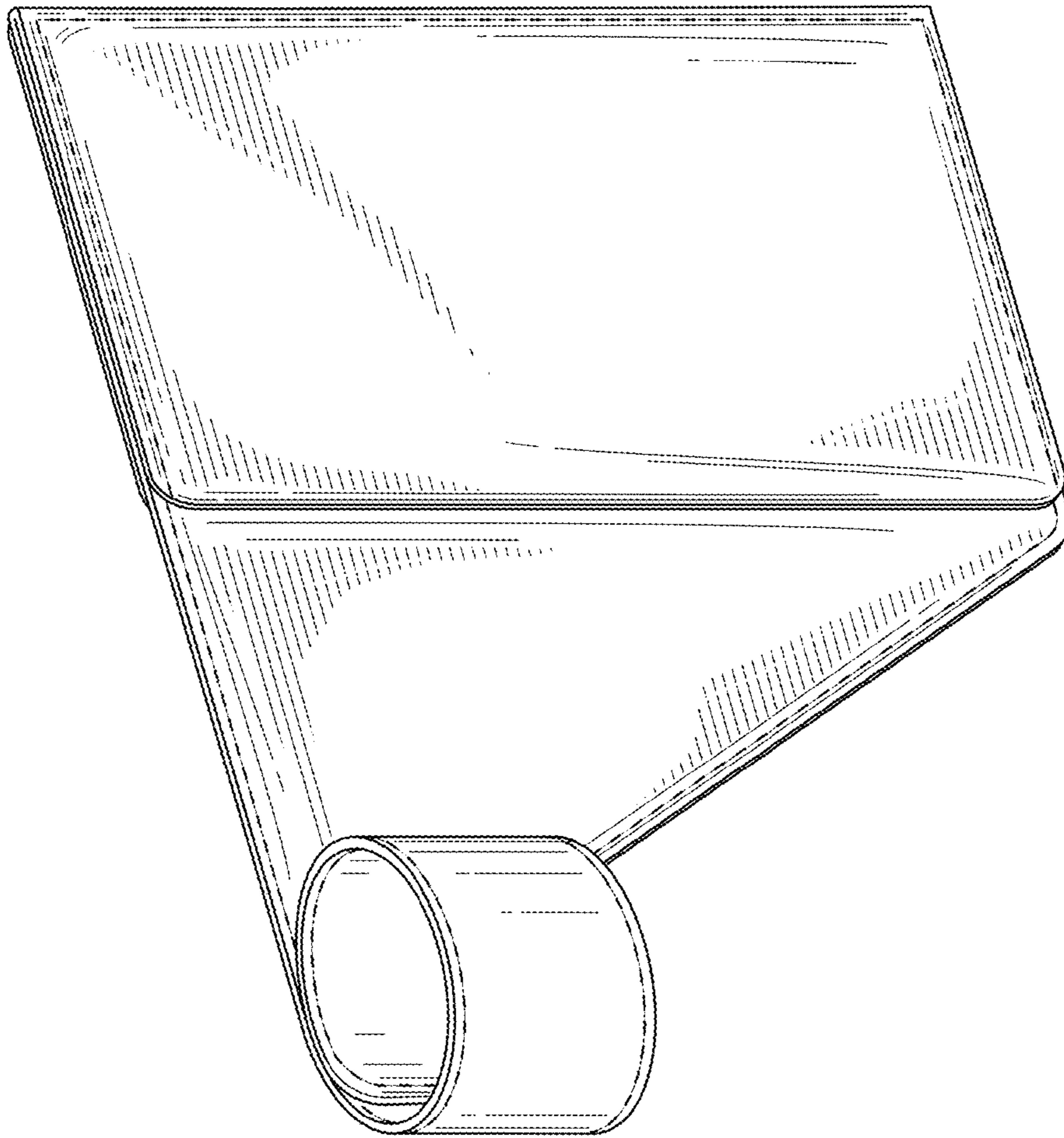

FIG. 20

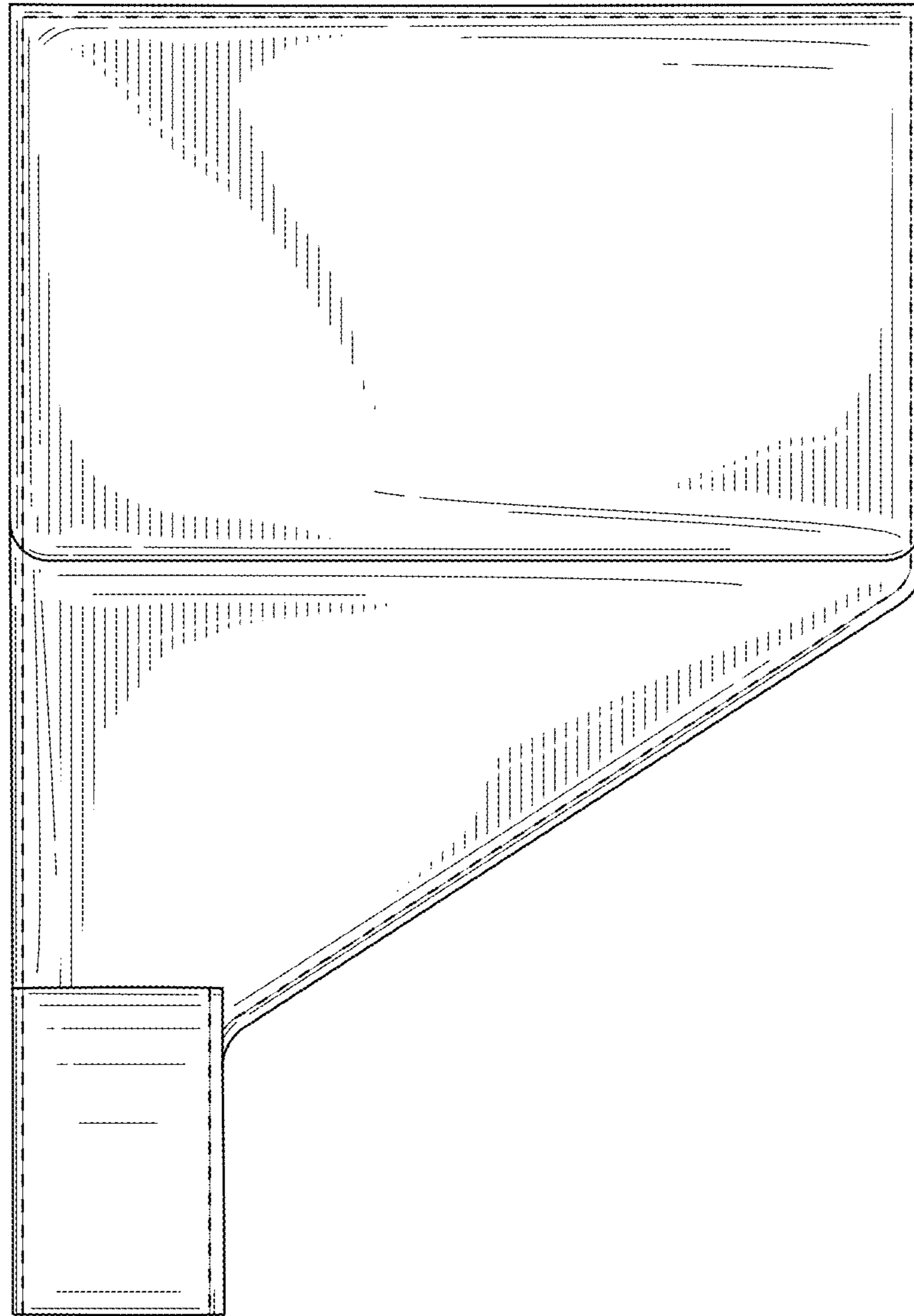

FIG. 21

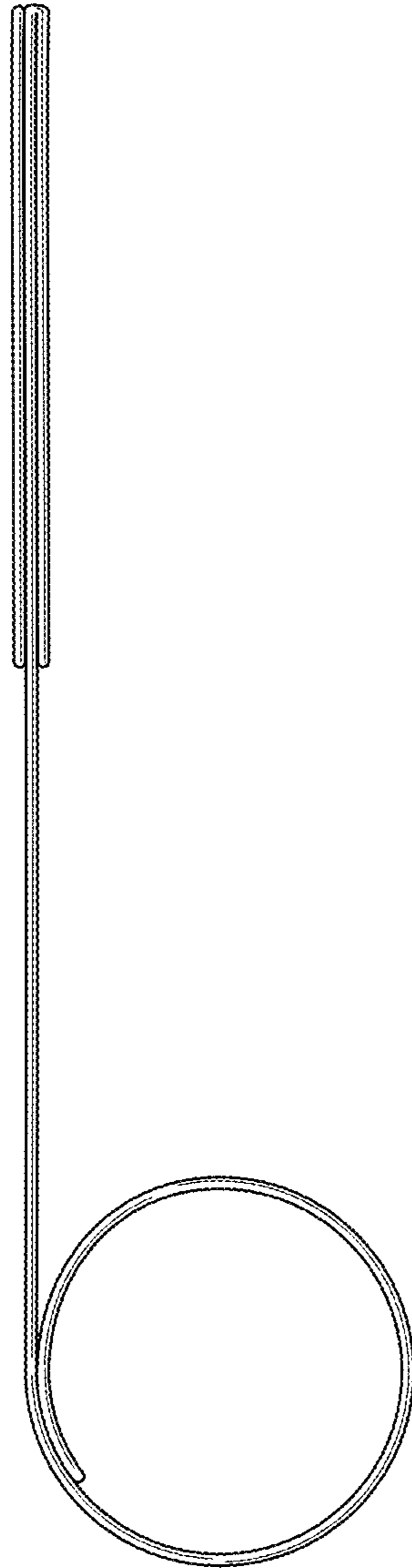

FIG. 22