



US00D835328S

(12) **United States Design Patent** (10) **Patent No.:** **US D835,328 S**
Silver et al. (45) **Date of Patent:** **** Dec. 4, 2018**

(54) **LUMINAIRE**
(71) Applicant: **Beta-Calco Inc.**, Toronto (CA)
(72) Inventors: **Remy Silver**, Toronto (CA); **Patrick Stark**, Toronto (CA); **Andrei Dumitru**, Ajax (CA); **Wade Figueria**, Maple (CA)

(73) Assignee: **BETA-CALCO INC.**, Toronto (CA)

(**) Term: **15 Years**

(21) Appl. No.: **29/562,184**

(22) Filed: **Apr. 22, 2016**

(51) **LOC (11) Cl.** **26-03**

(52) **U.S. Cl.**

USPC **D26/90**; D26/88

(58) **Field of Classification Search**

USPC D26/72, 80, 81, 84, 85, 86, 88, 90, 91, D26/118, 138, 142

CPC F21S 8/043; F21S 8/046; F21S 8/06; F21S 8/061; F21S 8/063; F21S 8/065; F21S 8/066; F21S 8/068; F21V 21/008; F21V 21/02; F21V 21/03; F21V 21/112; F21V 21/38

See application file for complete search history.

(56) **References Cited**

U.S. PATENT DOCUMENTS

D90,938 S *	10/1933	Beck	D26/88
D605,336 S *	12/2009	Miranda	D26/90
D671,676 S *	11/2012	Komarov	D26/88
D698,983 S *	2/2014	Rampolla	D26/88
D768,905 S *	10/2016	Sonneman	D26/88
D768,906 S *	10/2016	Sonneman	D26/88
D791,401 S *	7/2017	Sonneman	D26/152
2010/0220497 A1 *	9/2010	Ngai	F21S 8/06 362/610
2013/0027927 A1 *	1/2013	Wegger	F21S 8/06 362/235
2013/0329424 A1 *	12/2013	Clark	F21S 8/061 362/235

2015/0277030 A1 *	10/2015	Huang	F21S 8/061 362/611
2015/0300605 A1 *	10/2015	Clark	F21V 1/22 362/367
2015/0338038 A1 *	11/2015	Feit	F21S 8/061 362/147

OTHER PUBLICATIONS

RIO design by Kaia Lighting shown in the Ethnic Chic blog post titled 'Things You Need to Know About Kaia Lighting', dated Jan. 25, 2016. Found at blog.ethnicchic.com. (Year: 2016).*

Stillfried Wein Product Brochure for the RIO in and Out Ceiling fixtures by Kaia Lighting. Found at stillfried.com, visited Feb. 21, 2018 (Year: 2018).*

Kaia Lighting brochure for the RIO series lighting fixtures designed by Peter Straka in 2015. Dated Sep. 2016. (Year: 2016).*

Micro Ring De, Web Pin 137, by BetaCalco (c)2016. Document is time stamped Apr. 28, 2016 (Year: 2016).*

Sattler—Anello, <https://web.archive.org/web/20151117014745/http://www.sattler-lighting.com/en/portfolio/anello/>, Nov. 17, 2015.

Sattler—Circolo, <https://web.archive.org/web/20150417071940/http://www.sattler-lighting.com/en/portfolio/circolo-2/>, Apr. 17, 2015.

Sattler—Circolo Mini, <https://web.archive.org/web/20150914043313/http://www.sattler-lighting.com/en/portfolio/circolo-mini/>, Sep. 14, 2015.

Sattler—Ellipse, <https://web.archive.org/web/20150202034107/http://www.sattler-lighting.com/en/portfolio/ellipse-2/>, Feb. 2, 2015.

Sattler—Girata Horizontal, <https://web.archive.org/web/20150411064205/http://www.sattler-lighting.com/en/portfolio/girata-horizontal-2/>, Apr. 11, 2015.

Sattler—Inizio, <https://web.archive.org/web/20150912215119/http://www.sattler-lighting.com/en/portfolio/inizio/>, Sep. 12, 2015.

Sattler—Insieme, <https://web.archive.org/web/20150913045059/http://www.sattler-lighting.com/en/portfolio/insieme-2/>, Sep. 13, 2015.

Sattler—Insospeso Pendant, <https://web.archive.org/web/20141104084223/http://www.sattler-lighting.com/en/portfolio/insospeso-pendant/>, Nov. 4, 2014.

Sattler—Luce Verde Anello, <https://web.archive.org/web/20151031175922/http://www.sattler-lighting.com/en/portfolio/luce-verde-anello-2/>, Oct. 31, 2015.

Sattler—Luce Verde Slim, <https://web.archive.org/web/20151031150233/http://www.sattler-lighting.com/en/portfolio/luce-verde-slim-2/>, Oct. 31, 2015.

Sattler—Anello, North American Version, Specification Sheet (Jan. 11, 2016), p. 25 and 26.

Sattler—Slim Direct, North-American Version, Specification Sheet (Jan. 11, 2016), p. 52 and 53.

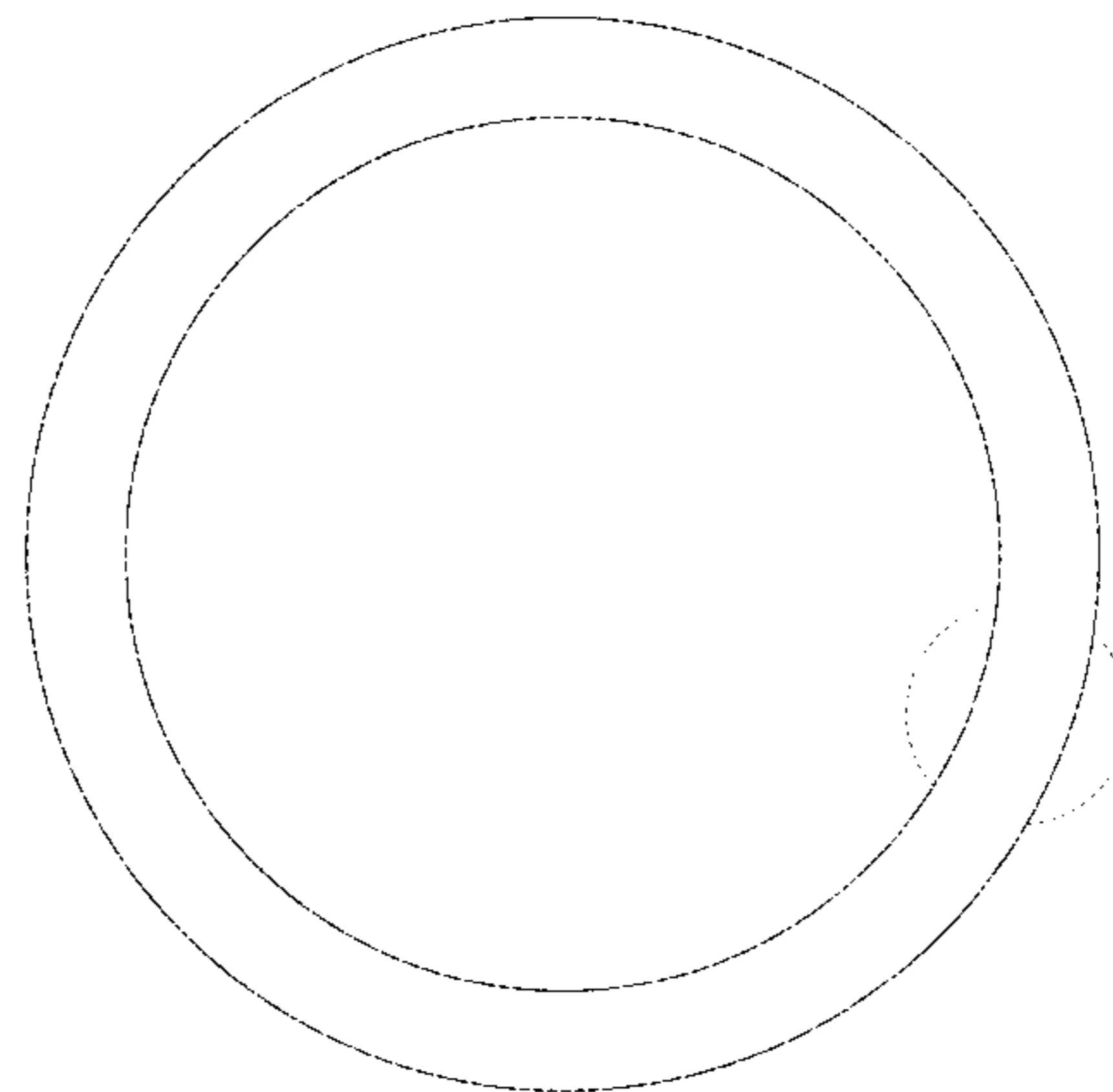
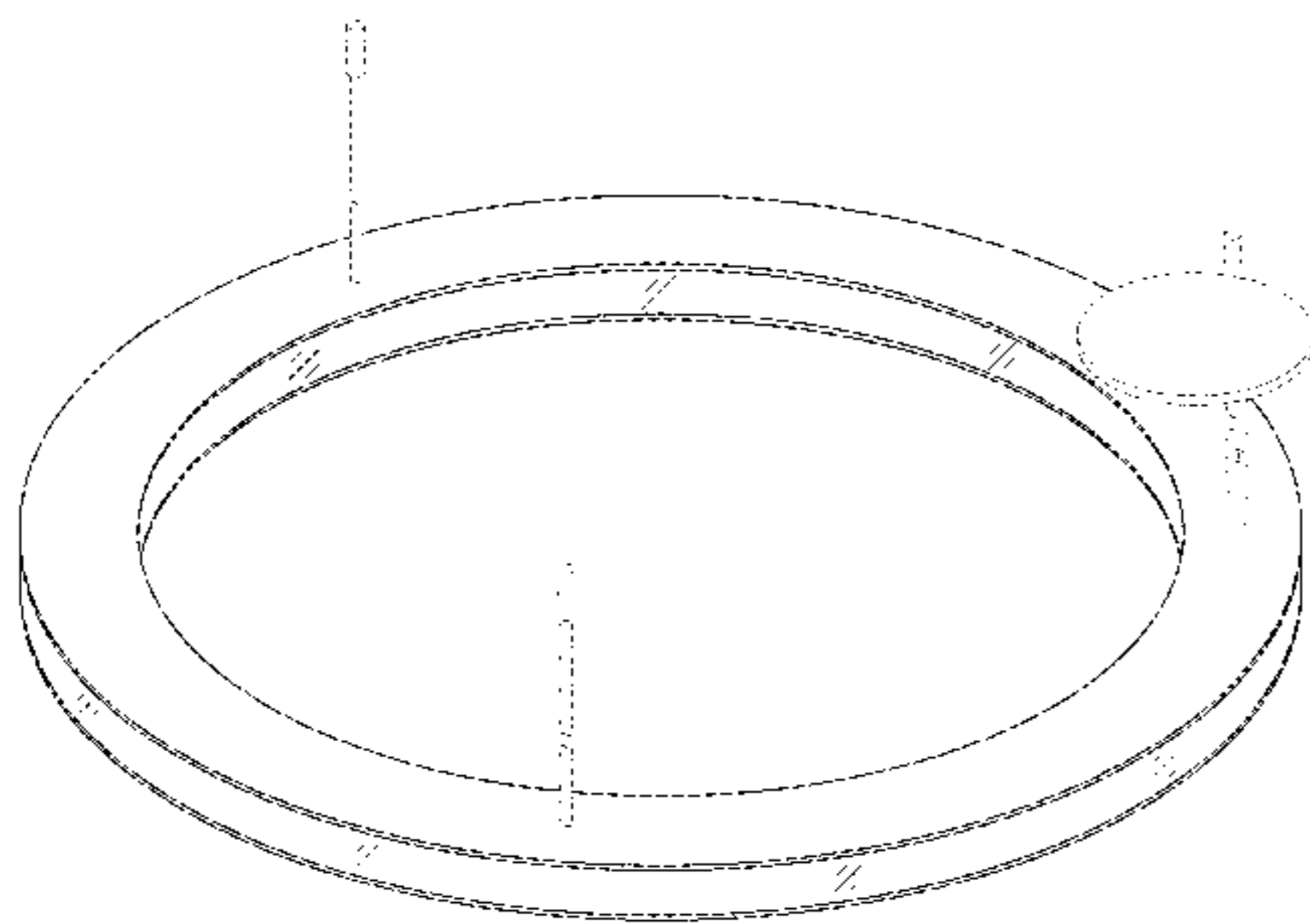

Sattler—Slim Indirect, North American Version, Specification Sheet (Jan. 11, 2016), p. 50 and 51.

Sattler Products, <https://web.archive.org/web/20160101170826/http://www.sattler-lighting.com/en/products/>, Jan. 1, 2016.

Sattler—Slim, <https://web.archive.org/web/20160127025133/http://www.sattler-lighting.com/en/portfolio/slim/>, Jan. 27, 2016.

Sattler—Toccatà, <https://web.archive.org/web/20151008144855/http://www.sattler-lighting.com/en/portfolio/toccatà-2/>, Oct. 8, 2015.

Sattler—Unione, <https://www.sattler-lighting.com/en/portfolio/unione/>, Sep. 11, 2015.

Lightnet—Ringo Star, <https://web.archive.org/web/20160118012808/http://lightnet.us/ringo-star-plg1-led-5.phtml>, Jan. 18, 2016.

Lightnet—Ringo Star 6, <http://www.lightnet.us/ringo-star-6.phtml>, Jan. 9, 2016.

Birchwood Lighting—Charlotte, <https://web.archive.org/web/20160407203212/http://birchwoodlighting.com/products/charlotte.html>, Apr. 7, 2016.

Birchwood Lighting—Charlotte, 3.25" Direct Distribution, Fixture Specification Sheet, https://web.archive.org/web/20151223113223/http://www.birchwoodlighting.com/products/pdfs/charlotte_dr.pdf, Dec. 23, 2015.

Birchwood Lighting—Charlotte, 3.25" Direct/Indirect Distribution, Fixture Specification Sheet, https://web.archive.org/web/20151123042829/http://www.birchwoodlighting.com/products/pdfs/charlotte_drin.pdf, Nov. 23, 2015.

Birchwood Lighting—Katrina, <https://web.archive.org/web/20160409083119/http://birchwoodlighting.com/products/katrina.html>, Apr. 9, 2016.

Birchwood Lighting—Katrina, Fixture Specification, <https://web.archive.org/web/20151223115316/http://www.birchwoodlighting.com/products/pdfs/katrina.pdf>, Dec. 23, 2015.

Castaldi Lighting—Norlight Bubble, <https://web.archive.org/web/20150614045241/http://www.castaldilighting.me.uk/products/bubble>, Jun. 14, 2015.

Castaldi Lighting—Norlight Bubble Up, https://web.archive.org/web/20150617050535/http://www.castaldilighting.me.uk/products/bubble_up, Jun. 17, 2015.

Castaldi Lighting—Norlight Half, <https://web.archive.org/web/20150617050802/http://www.castaldilighting.me.uk/products/half>, Jun. 17, 2004.

Eureka Lighting—Cycle 3800-24, -36, -54, -72 Specification, 2014.
Eureka Lighting—Cycle 3800-24, -36, -54, -72 Specification (2), 2014.

Eureka Lighting—Cycle 4800-54-WH, <https://web.archive.org/web/20160402100726/http://www.eurekalighting.com/productDetails.aspx?productId=4800-54&Cat=E4B>, Apr. 2, 2016.

Eureka Lighting—Cycle 4800-72-WH, <https://web.archive.org/web/20150214032441/http://www.eurekalighting.com/productDetails.aspx?productId=4800-72&Cat=E4B>, Feb. 14, 2015.

Eureka Lighting—Cycle 4800-24/36 Product Sheet, printed prior to Apr. 22, 2016.

Eureka Lighting—Cycle 4800-54/72 Product Sheet, 2015.

Eureka Lighting—Cycle 4800-115/152 Product Sheet, 2015.

Eureka Lighting—Cycle Layers 4844-2 Specification, 2015.

Eureka Lighting—Cycle Layers 4844-3 Specification, 2015.

Eureka Lighting Product Page Snapshot of 3800 Cycle Series; <https://web.archive.org/web/20150426170634/http://www.eurekalighting.com/productscategory.aspx?page=1&cat=ALL>, Apr. 26, 2015.

Eureka Lighting Product Page Snapshot of 4800 Cycle Series and Odeon; <https://web.archive.org/web/20150426170634/http://www.eurekalighting.com/productscategory.aspx?page=1&cat=ALL>, Apr. 26, 2015.

Eureka Lighting—Odeon 4805-80/118 Specification; 2014-2015.

Beta Calco—Bubble, Web Pin 298, General Specification, Jul. 21, 2014.

Beta Calco—Bubble 3D, Web Pin 117, General Specification, Mar. 31, 2014.

Beta Calco—Bubble 3D RGB, Web Pin 259, General Specification, Jul. 21, 2014.

Beta Calco—Bubble RGB, Web Pin 260, General Specification; Jul. 21, 2014.

Beta Calco—Bubble Up, Web Pin 433, General Specification, Jul. 21, 2014.

Beta Calco—United Utilities, Q-06825 Quarter Ring 2, General Specification, Mar. 2015.

Beta Calco—Ring, White LED Direct Illumination, Web Pin 100, General Specification, Apr. 1, 2015.

Beta Calco—Ring, White LED Direct & Indirect Illumination, Web Pin 100, General Specification, Mar. 31, 2015.

Beta Calco—Ring, Static Color LED Direct Illumination, Web Pin 100, General Specification, May 5, 2015.

* cited by examiner

Primary Examiner — Clare E Heflin

(74) *Attorney, Agent, or Firm* — Renner, Otto, Boisselle & Sklar, LLP

(57)

CLAIM

The ornamental design for a luminaire, as shown and described.

DESCRIPTION

FIG. 1 is a perspective view of a luminaire showing a first variant of the design;

FIG. 2 is a top view of the luminaire of FIG. 1;

FIG. 3 is a bottom view of the luminaire of FIG. 1;

FIG. 4 is a front view of the luminaire of FIG. 1;

FIG. 5 is a rear view of the luminaire of FIG. 1;

FIG. 6 is an enlarged fragmentary view of the portion of the luminaire identified in FIG. 5;

FIG. 7 is a perspective view of a luminaire showing a second variant of the design;

FIG. 8 is a top view of the luminaire of FIG. 7;

FIG. 9 is a bottom view of the luminaire of FIG. 7;

FIG. 10 is a front view of the luminaire of FIG. 7;

FIG. 11 is a rear view of the luminaire of FIG. 7;

FIG. 12 is an enlarged fragmentary view of the portion of the luminaire identified in FIG. 11;

FIG. 13 is a perspective view of a luminaire showing a third variant of the design;

FIG. 14 is a top view of the luminaire of FIG. 13;

FIG. 15 is a bottom view of the luminaire of FIG. 13;

FIG. 16 is a front view of the luminaire of FIG. 13;

FIG. 17 is a rear view of the luminaire of FIG. 13;

FIG. 18 is a perspective view of a luminaire showing a fourth variant of the design;

FIG. 19 is a top view of the luminaire of FIG. 18;

FIG. 20 is a bottom view of the luminaire of FIG. 18;

FIG. 21 is a front view of the luminaire of FIG. 18;

FIG. 22 is a rear view of the luminaire of FIG. 18;

FIG. 23 is a perspective view of a luminaire showing a fifth variant of the design;

FIG. 24 is a top view of the luminaire of FIG. 23;

FIG. 25 is a bottom view of the luminaire of FIG. 23;

FIG. 26 is a front view of the luminaire of FIG. 23;

FIG. 27 is a rear view of the luminaire of FIG. 23;

FIG. 28 is an enlarged fragmentary view of the portion of the luminaire identified in FIG. 27;

FIG. 29 is a perspective view of a luminaire showing a sixth variant of the design;

FIG. 30 is a top view of the luminaire of FIG. 29;

FIG. 31 is a bottom view of the luminaire of FIG. 29;

FIG. 32 is a front view of the luminaire of FIG. 29;

FIG. 33 is a rear view of the luminaire of FIG. 29;

FIG. 34 is an enlarged fragmentary view of the portion of the luminaire identified in FIG. 33;
FIG. 35 is a perspective view of a luminaire showing a seventh variant of the design;
FIG. 36 is a top view of the luminaire of FIG. 35;
FIG. 37 is a bottom view of the luminaire of FIG. 35;
FIG. 38 is a front view of the luminaire of FIG. 35;
FIG. 39 is a rear view of the luminaire of FIG. 35;
FIG. 40 is a perspective view of a luminaire showing an eighth variant of the design;
FIG. 41 is a top view of the luminaire of FIG. 40;
FIG. 42 is a bottom view of the luminaire of FIG. 40;
FIG. 43 is a front view of the luminaire of FIG. 40;
FIG. 44 is a rear view of the luminaire of FIG. 40;
FIG. 45 is a perspective view of a luminaire showing a ninth variant of the design;
FIG. 46 is a top view of the luminaire of FIG. 45;
FIG. 47 is a bottom view of the luminaire of FIG. 45;
FIG. 48 is a front view of the luminaire of FIG. 45;
FIG. 49 is a rear view of the luminaire of FIG. 45;
FIG. 50 is an enlarged fragmentary view of the portion of the luminaire identified in FIG. 49;
FIG. 51 is a perspective view of a luminaire showing a tenth variant of the design;
FIG. 52 is a top view of the luminaire of FIG. 51;
FIG. 53 is a bottom view of the luminaire of FIG. 51;
FIG. 54 is a front view of the luminaire of FIG. 51;
FIG. 55 is a rear view of the luminaire of FIG. 51;
FIG. 56 is an enlarged fragmentary view of the portion of the luminaire identified in FIG. 55;
FIG. 57 is a perspective view of a luminaire showing an eleventh variant of the design;
FIG. 58 is a top view of the luminaire of FIG. 57;
FIG. 59 is a bottom view of the luminaire of FIG. 57;
FIG. 60A is an enlarged fragmentary view of the portion of the luminaire identified in FIG. 58;
FIG. 60B is an enlarged fragmentary view of the portion of the luminaire identified in FIG. 59;
FIG. 61 is a front view of the luminaire of FIG. 57;
FIG. 62 is a rear view of the luminaire of FIG. 57;
FIG. 63 is a perspective view of a luminaire showing a twelfth variant of the design;
FIG. 64 is a top view of the luminaire of FIG. 63;
FIG. 65 is a bottom view of the luminaire of FIG. 63;
FIG. 66A is an enlarged fragmentary view of the portion of the luminaire identified in FIG. 64;
FIG. 66B is an enlarged fragmentary view of the portion of the luminaire identified in FIG. 65;
FIG. 67 is a front view of the luminaire of FIG. 63;
FIG. 68 is a rear view of the luminaire of FIG. 63;
FIG. 69 is a perspective view of a luminaire showing a thirteenth variant of the design;
FIG. 70 is a top view of the luminaire of FIG. 69;
FIG. 71 is a bottom view of the luminaire of FIG. 69;
FIG. 72 is a front view of the luminaire of FIG. 69;
FIG. 73 is a rear view of the luminaire of FIG. 69;
FIG. 74 is an enlarged fragmentary view of the portion of the luminaire identified in FIG. 73;
FIG. 75 is a perspective view of a luminaire showing a fourteenth variant of the design;
FIG. 76 is a top view of the luminaire of FIG. 75;
FIG. 77 is a bottom view of the luminaire of FIG. 75;
FIG. 78 is a front view of the luminaire of FIG. 75;
FIG. 79 is a rear view of the luminaire of FIG. 75;

FIG. 80 is an enlarged fragmentary view of the portion of the luminaire identified in FIG. 79;
FIG. 81 is a perspective view of a luminaire showing a fifteenth variant of the design;
FIG. 82 is a top view of the luminaire of FIG. 81;
FIG. 83 is a bottom view of the luminaire of FIG. 81;
FIG. 84A is an enlarged fragmentary view of the portion of the luminaire identified in FIG. 82;
FIG. 84B is an enlarged fragmentary view of the portion of the luminaire identified in FIG. 83;
FIG. 85 is a front view of the luminaire of FIG. 81;
FIG. 86 is a rear view of the luminaire of FIG. 81;
FIG. 87 is a perspective view of a luminaire showing a sixteenth variant of the design;
FIG. 88 is a top view of the luminaire of FIG. 87;
FIG. 89 is a bottom view of the luminaire of FIG. 87;
FIG. 90A is an enlarged fragmentary view of the portion of the luminaire identified in FIG. 88;
FIG. 90B is an enlarged fragmentary view of the portion of the luminaire identified in FIG. 89;
FIG. 91 is a front view of the luminaire of FIG. 87;
FIG. 92 is a rear view of the luminaire of FIG. 87;
FIG. 93 is a perspective view of a luminaire showing a seventeenth variant of the design;
FIG. 94 is a top view of the luminaire of FIG. 93;
FIG. 95 is a bottom view of the luminaire of FIG. 93;
FIG. 96 is a front view of the luminaire of FIG. 93;
FIG. 97 is a rear view of the luminaire of FIG. 93;
FIG. 98 is an enlarged fragmentary view of the portion of the luminaire identified in FIG. 97;
FIG. 99 is a perspective view of a luminaire showing an eighteenth variant of the design;
FIG. 100 is a top view of the luminaire of FIG. 99;
FIG. 101 is a bottom view of the luminaire of FIG. 99;
FIG. 102 is a front view of the luminaire of FIG. 99;
FIG. 103 is a rear view of the luminaire of FIG. 99;
FIG. 104 is an enlarged fragmentary view of the portion of the luminaire identified in FIG. 103;
FIG. 105 is a perspective view of a luminaire showing a nineteenth variant of the design;
FIG. 106 is a top view of the luminaire of FIG. 105;
FIG. 107 is a bottom view of the luminaire of FIG. 105;
FIG. 108A is an enlarged fragmentary view of the portion of the luminaire identified in FIG. 106;
FIG. 108B is an enlarged fragmentary view of the portion of the luminaire identified in FIG. 107;
FIG. 109 is a front view of the luminaire of FIG. 105;
FIG. 110 is a rear view of the luminaire of FIG. 105;
FIG. 111 is a perspective view of a luminaire showing a twentieth variant of the design;
FIG. 112 is a top view of the luminaire of FIG. 111;
FIG. 113 is a bottom view of the luminaire of FIG. 111;
FIG. 114A is an enlarged fragmentary view of the portion of the luminaire identified in FIG. 112;
FIG. 114B is an enlarged fragmentary view of the portion of the luminaire identified in FIG. 113;
FIG. 115 is a front view of the luminaire of FIG. 111;
FIG. 116 is a rear view of the luminaire of FIG. 111;
FIG. 117 is a perspective view of a luminaire showing a twenty-first variant of the design;
FIG. 118 is a top view of the luminaire of FIG. 117;
FIG. 119 is a bottom view of the luminaire of FIG. 117;
FIG. 120 is a front view of the luminaire of FIG. 117;
FIG. 121 is a rear view of the luminaire of FIG. 117;

FIG. 122 is an enlarged fragmentary view of the portion of the luminaire identified in FIG. 121;
FIG. 123 is a perspective view of a luminaire showing a twenty-second variant of the design;
FIG. 124 is a top view of the luminaire of FIG. 123;
FIG. 125 is a bottom view of the luminaire of FIG. 123;
FIG. 126 is a front view of the luminaire of FIG. 123;
FIG. 127 is a rear view of the luminaire of FIG. 123;
FIG. 128 is an enlarged fragmentary view of the portion of the luminaire identified in FIG. 127;
FIG. 129 is a perspective view of a luminaire showing a twenty-third variant of the design;
FIG. 130 is a top view of the luminaire of FIG. 129;
FIG. 131 is a bottom view of the luminaire of FIG. 129;
FIG. 132A is an enlarged fragmentary view of the portion of the luminaire identified in FIG. 130;
FIG. 132B is an enlarged fragmentary view of the portion of the luminaire identified in FIG. 131;
FIG. 133 is a front view of the luminaire of FIG. 129;
FIG. 134 is a rear view of the luminaire of FIG. 129;
FIG. 135 is a perspective view of a luminaire showing a twenty-fourth variant of the design;
FIG. 136 is a top view of the luminaire of FIG. 135;
FIG. 137 is a bottom view of the luminaire of FIG. 135;
FIG. 138A is an enlarged fragmentary view of the portion of the luminaire identified in FIG. 136;
FIG. 138B is an enlarged fragmentary view of the portion of the luminaire identified in FIG. 137;
FIG. 139 is a front view of the luminaire of FIG. 135;
FIG. 140 is a rear view of the luminaire of FIG. 135;
FIG. 141 is a perspective view of a luminaire showing a twenty-fifth variant of the design;
FIG. 142 is a top view of the luminaire of FIG. 141;
FIG. 143 is a bottom view of the luminaire of FIG. 141;
FIG. 144 is a front view of the luminaire of FIG. 141;
FIG. 145 is a rear view of the luminaire of FIG. 141;
FIG. 146 is an enlarged fragmentary view of the portion of the luminaire identified in FIG. 145;
FIG. 147 is a perspective view of a luminaire showing a twenty-sixth variant of the design;
FIG. 148 is a top view of the luminaire of FIG. 147;
FIG. 149 is a bottom view of the luminaire of FIG. 147;
FIG. 150 is a front view of the luminaire of FIG. 147;
FIG. 151 is a rear view of the luminaire of FIG. 147;
FIG. 152 is an enlarged fragmentary view of the portion of the luminaire identified in FIG. 151;
FIG. 153 is a perspective view of a luminaire showing a twenty-seventh variant of the design;
FIG. 154 is a top view of the luminaire of FIG. 153;
FIG. 155 is a bottom view of the luminaire of FIG. 153;
FIG. 156A is an enlarged fragmentary view of the portion of the luminaire identified in FIG. 154;
FIG. 156B is an enlarged fragmentary view of the portion of the luminaire identified in FIG. 155;
FIG. 157 is a front view of the luminaire of FIG. 153;
FIG. 158 is a rear view of the luminaire of FIG. 153;
FIG. 159 is a perspective view of a luminaire showing a twenty-eighth variant of the design;
FIG. 160 is a top view of the luminaire of FIG. 159;
FIG. 161 is a bottom view of the luminaire of FIG. 159;
FIG. 162A is an enlarged fragmentary view of the portion of the luminaire identified in FIG. 160;
FIG. 162B is an enlarged fragmentary view of the portion of the luminaire identified in FIG. 161;
FIG. 163 is a front view of the luminaire of FIG. 159;

FIG. 164 is a rear view of the luminaire of FIG. 159;
FIG. 165 is a perspective view of a luminaire showing a twenty-ninth variant of the design;
FIG. 166 is a top view of the luminaire of FIG. 165;
FIG. 167 is a bottom view of the luminaire of FIG. 165;
FIG. 168 is a front view of the luminaire of FIG. 165;
FIG. 169 is a rear view of the luminaire of FIG. 165;
FIG. 170 is an enlarged fragmentary view of the portion of the luminaire identified in FIG. 169;
FIG. 171 is a perspective view of a luminaire showing a thirtieth variant of the design;
FIG. 172 is a top view of the luminaire of FIG. 171;
FIG. 173 is a bottom view of the luminaire of FIG. 171;
FIG. 174 is a front view of the luminaire of FIG. 171;
FIG. 175 is a rear view of the luminaire of FIG. 171;
FIG. 176 is an enlarged fragmentary view of the portion of the luminaire identified in FIG. 175;
FIG. 177 is a perspective view of a luminaire showing a thirty-first variant of the design;
FIG. 178 is a top view of the luminaire of FIG. 177;
FIG. 179 is a bottom view of the luminaire of FIG. 177;
FIG. 180A is an enlarged fragmentary view of the portion of the luminaire identified in FIG. 178;
FIG. 180B is an enlarged fragmentary view of the portion of the luminaire identified in FIG. 179;
FIG. 181 is a front view of the luminaire of FIG. 177;
FIG. 182 is a rear view of the luminaire of FIG. 177;
FIG. 183 is a perspective view of a luminaire showing a thirty-second variant of the design;
FIG. 184 is a top view of the luminaire of FIG. 183;
FIG. 185 is a bottom view of the luminaire of FIG. 183;
FIG. 186A is an enlarged fragmentary view of the portion of the luminaire identified in FIG. 184;
FIG. 186B is an enlarged fragmentary view of the portion of the luminaire identified in FIG. 185;
FIG. 187 is a front view of the luminaire of FIG. 183;
FIG. 188 is a rear view of the luminaire of FIG. 183;
FIG. 189 is a perspective view of a luminaire showing a thirty-third variant of the design;
FIG. 190 is a top view of the luminaire of FIG. 189;
FIG. 191 is a bottom view of the luminaire of FIG. 189;
FIG. 192 is a front view of the luminaire of FIG. 189;
FIG. 193 is a rear view of the luminaire of FIG. 189;
FIG. 194 is an enlarged fragmentary view of the portion of the luminaire identified in FIG. 193;
FIG. 195 is a perspective view of a luminaire showing a thirty-fourth variant of the design;
FIG. 196 is a top view of the luminaire of FIG. 195;
FIG. 197 is a bottom view of the luminaire of FIG. 195;
FIG. 198 is a front view of the luminaire of FIG. 195;
FIG. 199 is a rear view of the luminaire of FIG. 195;
FIG. 200 is an enlarged fragmentary view of the portion of the luminaire identified in FIG. 199;
FIG. 201 is a perspective view of a luminaire showing a thirty-fifth variant of the design;
FIG. 202 is a top view of the luminaire of FIG. 201;
FIG. 203 is a bottom view of the luminaire of FIG. 201;
FIG. 204A is an enlarged fragmentary view of the portion of the luminaire identified in FIG. 202;
FIG. 204B is an enlarged fragmentary view of the portion of the luminaire identified in FIG. 203;
FIG. 205 is a front view of the luminaire of FIG. 201;
FIG. 206 is a rear view of the luminaire of FIG. 201;
FIG. 207 is a perspective view of a luminaire showing a thirty-sixth variant of the design;

FIG. 208 is a top view of the luminaire of FIG. 207;
FIG. 209 is a bottom view of the luminaire of FIG. 207;
FIG. 210A is an enlarged fragmentary view of the portion of the luminaire identified in FIG. 208;
FIG. 210B is an enlarged fragmentary view of the portion of the luminaire identified in FIG. 209;
FIG. 211 is a front view of the luminaire of FIG. 207;
FIG. 212 is a rear view of the luminaire of FIG. 207;
FIG. 213 is a perspective view of a luminaire showing a thirty-seventh variant of the design;
FIG. 214 is a top view of the luminaire of FIG. 213;
FIG. 215 is a bottom view of the luminaire of FIG. 213;
FIG. 216 is a front view of the luminaire of FIG. 213;
FIG. 217 is a rear view of the luminaire of FIG. 213;
FIG. 218 is an enlarged fragmentary view of the portion of the luminaire identified in FIG. 217;
FIG. 219 is a perspective view of a luminaire showing a thirty-eighth variant of the design;
FIG. 220 is a top view of the luminaire of FIG. 219;
FIG. 221 is a bottom view of the luminaire of FIG. 219;
FIG. 222 is a front view of the luminaire of FIG. 219;
FIG. 223 is a rear view of the luminaire of FIG. 219;
FIG. 224 is an enlarged fragmentary view of the portion of the luminaire identified in FIG. 223;

FIG. 225 is a perspective view of a luminaire showing a thirty-ninth variant of the design;
FIG. 226 is a top view of the luminaire of FIG. 225;
FIG. 227 is a bottom view of the luminaire of FIG. 225;
FIG. 228A is an enlarged fragmentary view of the portion of the luminaire identified in FIG. 226;
FIG. 228B is an enlarged fragmentary view of the portion of the luminaire identified in FIG. 227;
FIG. 229 is a front view of the luminaire of FIG. 225;
FIG. 230 is a rear view of the luminaire of FIG. 225;
FIG. 231 is a perspective view of a luminaire showing a fortieth variant of the design;
FIG. 232 is a top view of the luminaire of FIG. 231;
FIG. 233 is a bottom view of the luminaire of FIG. 231;
FIG. 234A is an enlarged fragmentary view of the portion of the luminaire identified in FIG. 232;
FIG. 234B is an enlarged fragmentary view of the portion of the luminaire identified in FIG. 233;
FIG. 235 is a front view of the luminaire of FIG. 231; and,
FIG. 236 is a rear view of the luminaire of FIG. 231.
The portions of the luminaire shown in broken lines form no part of the design. The thin diagonal lines on the inner and outer side walls of the luminaire represent translucency. The shaded portions of the luminaire represent color contrast.

1 Claim, 160 Drawing Sheets

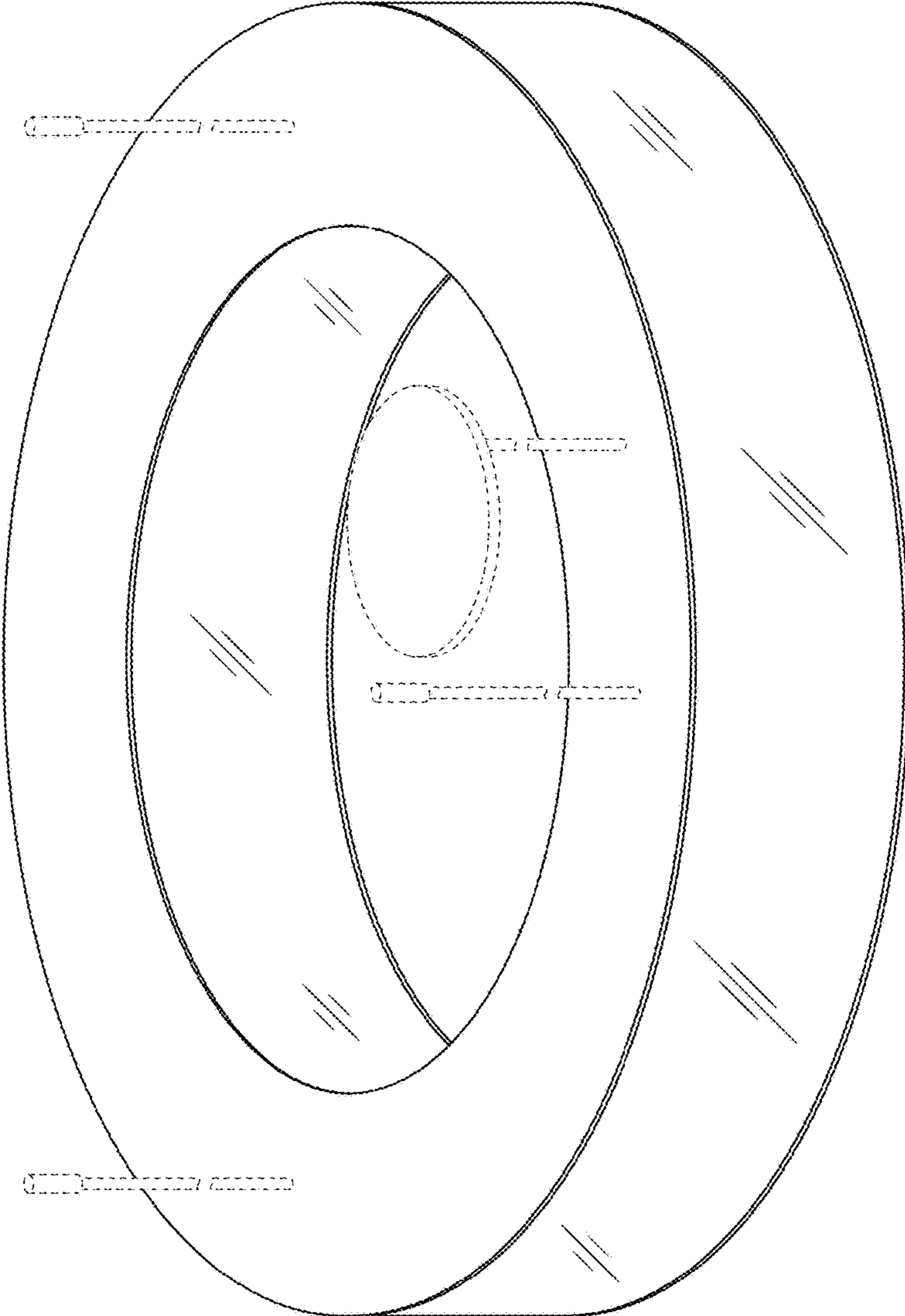

FIG. 1

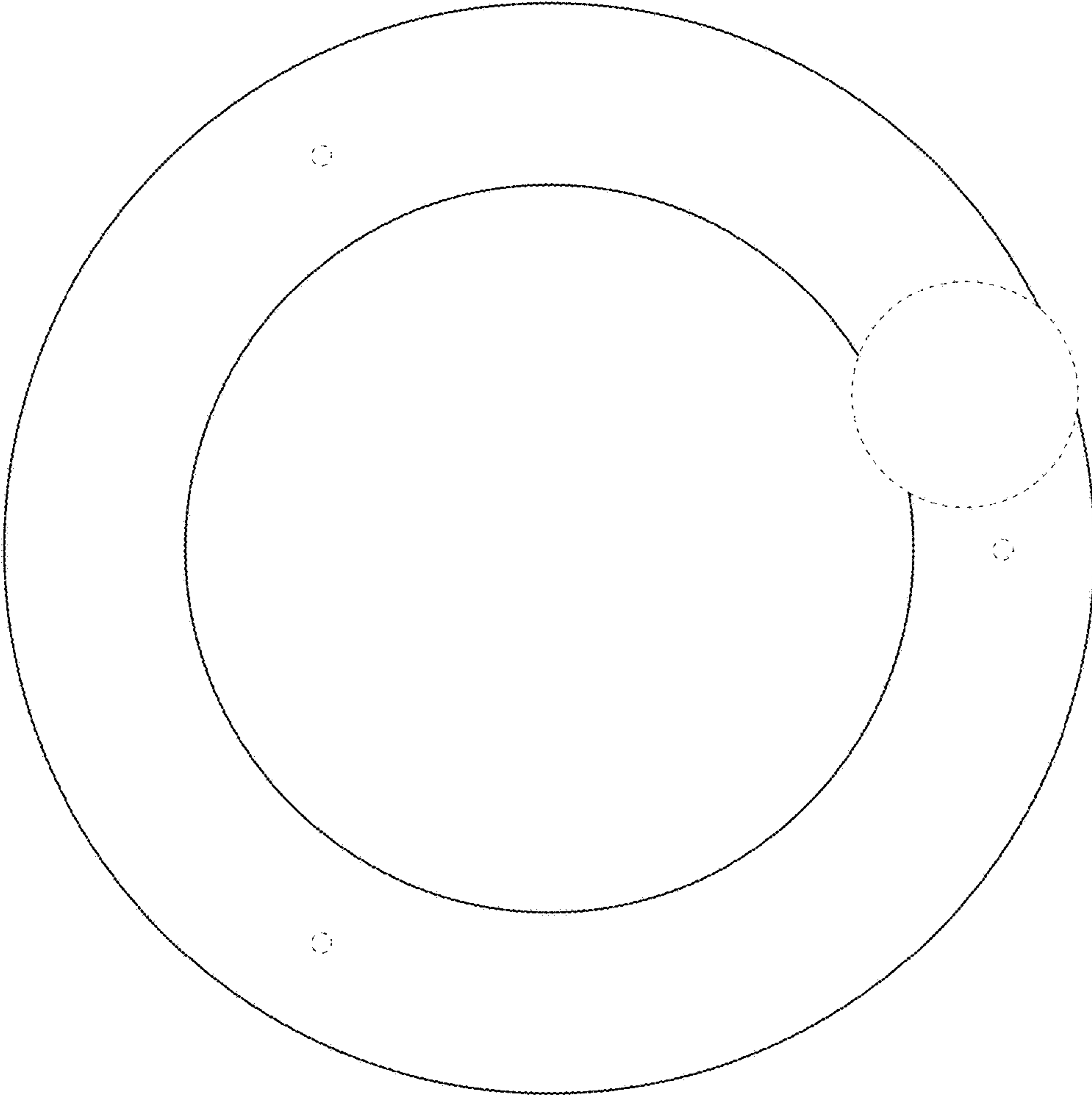

FIG. 2

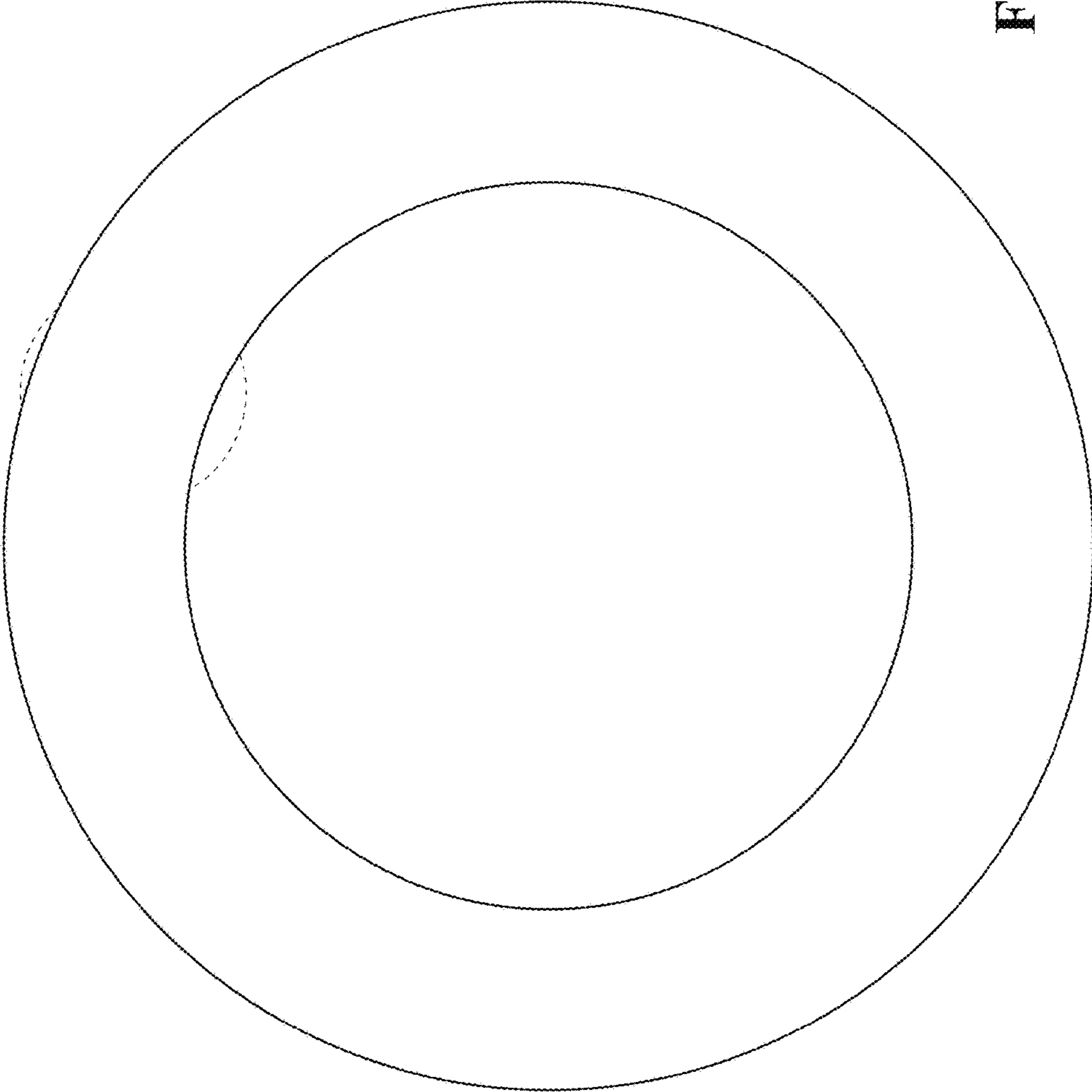

FIG. 3

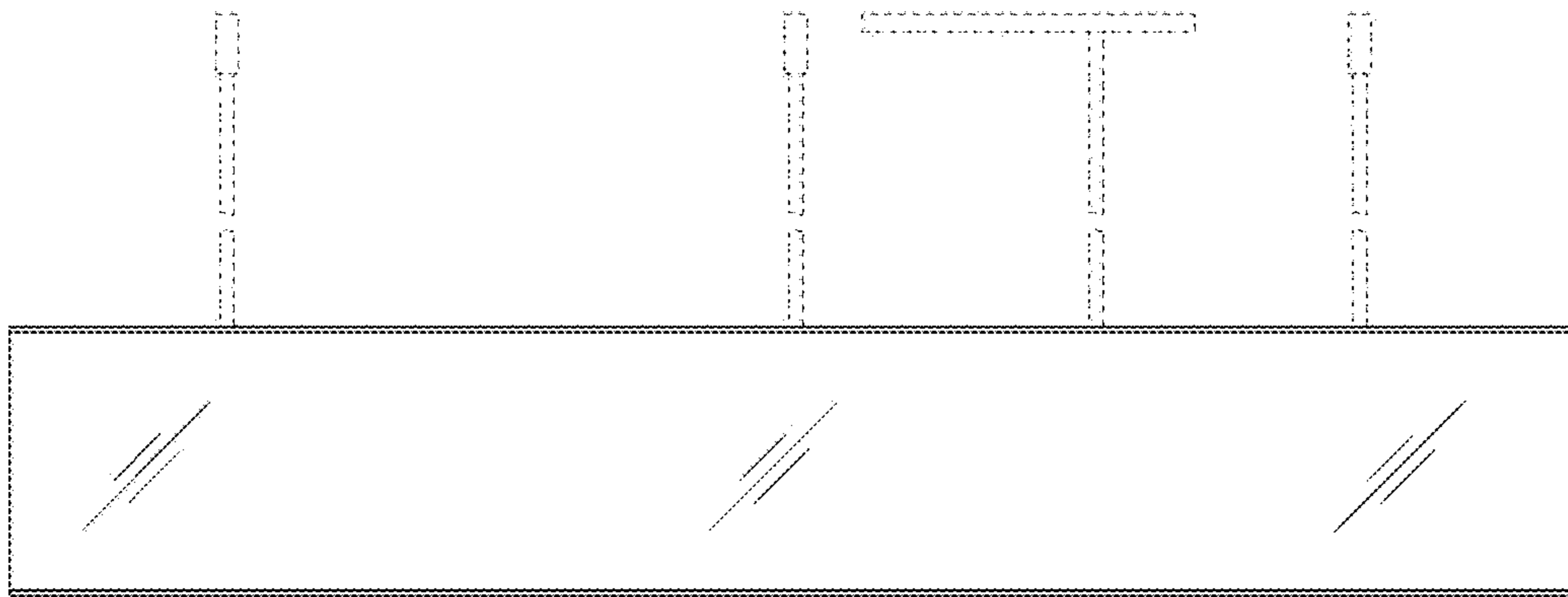

FIG. 4

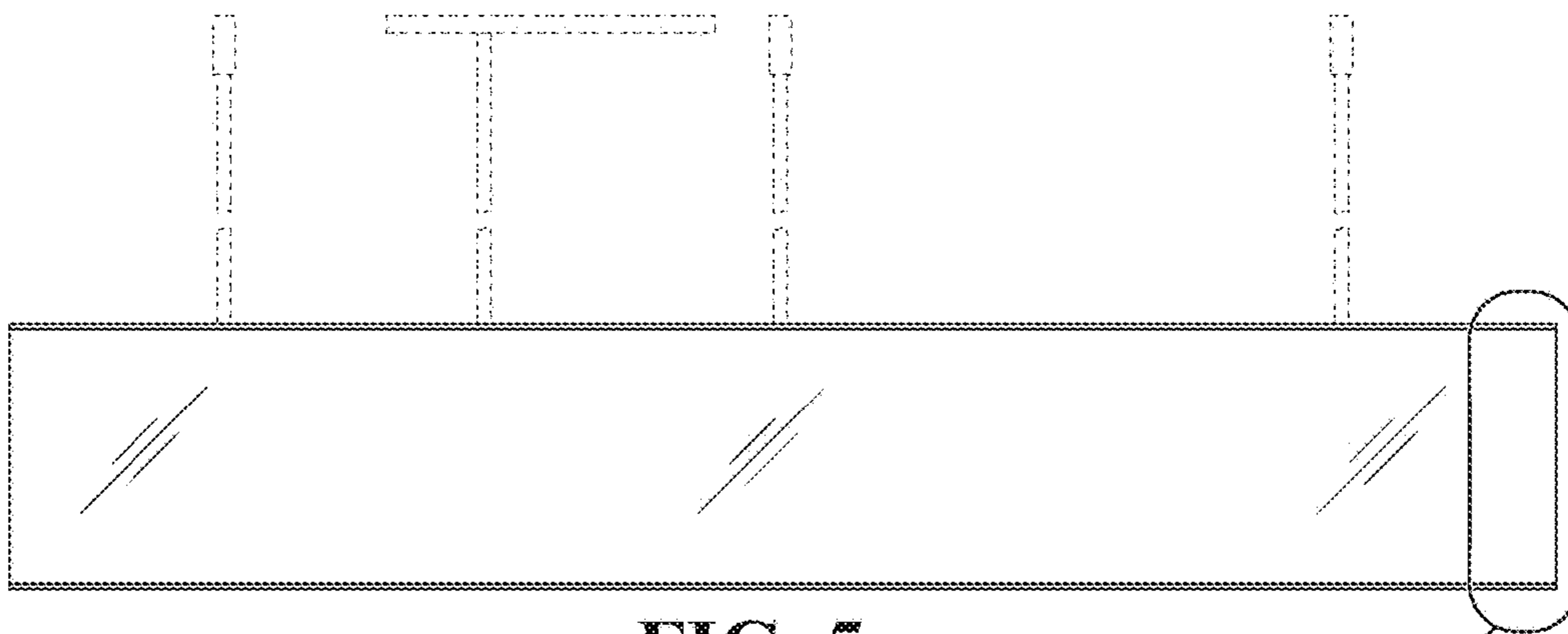

FIG. 5

FIG. 6

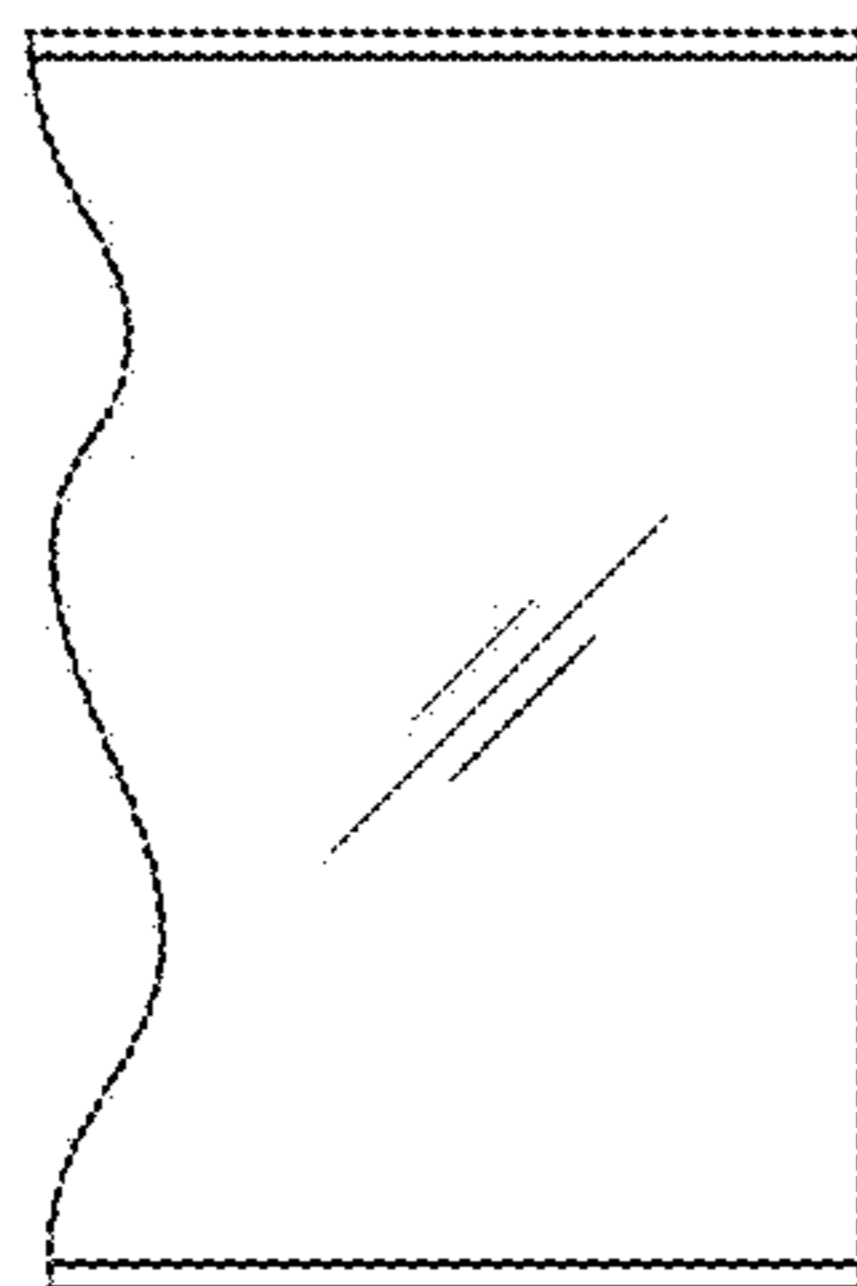

FIG. 6

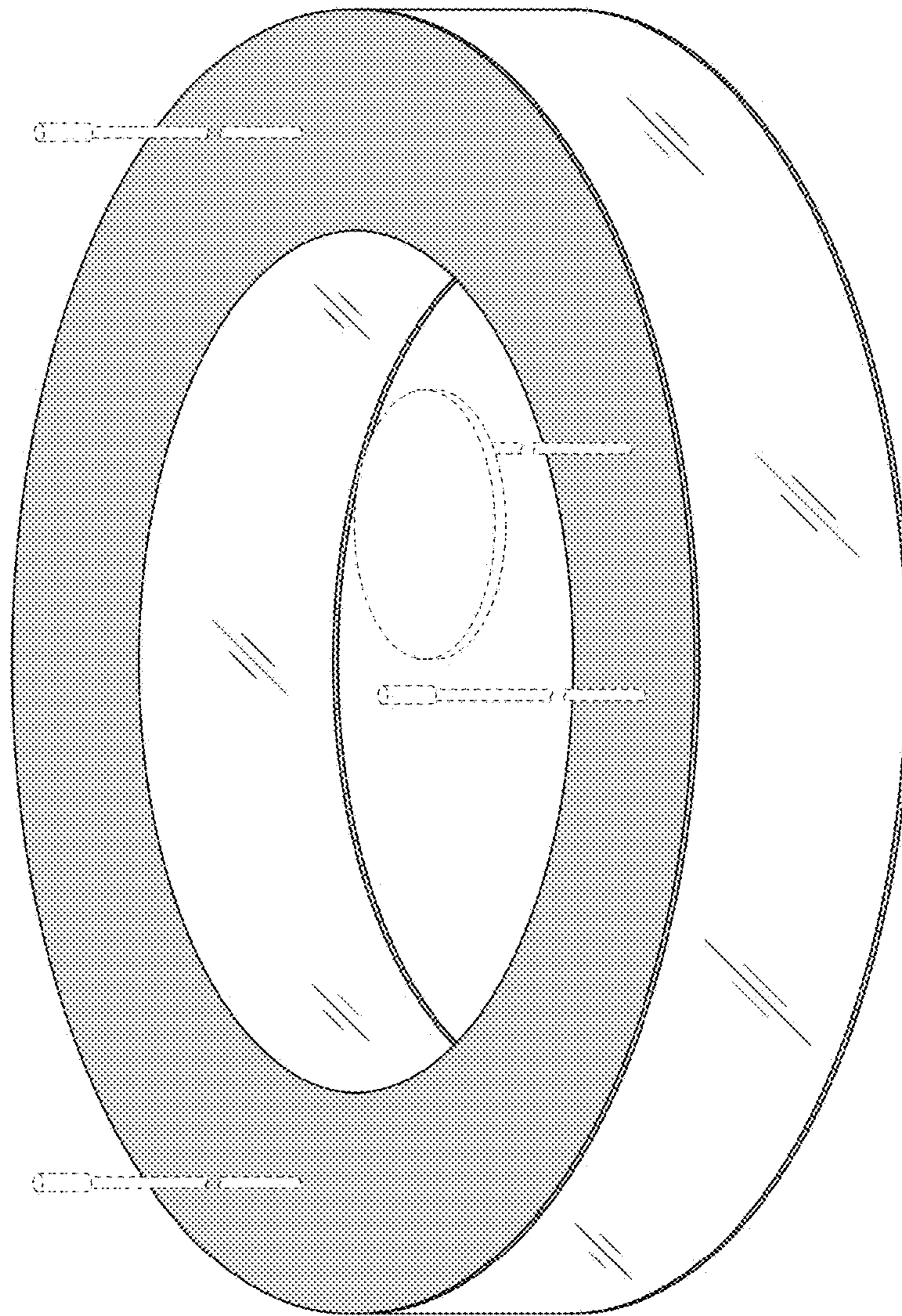

FIG. 7

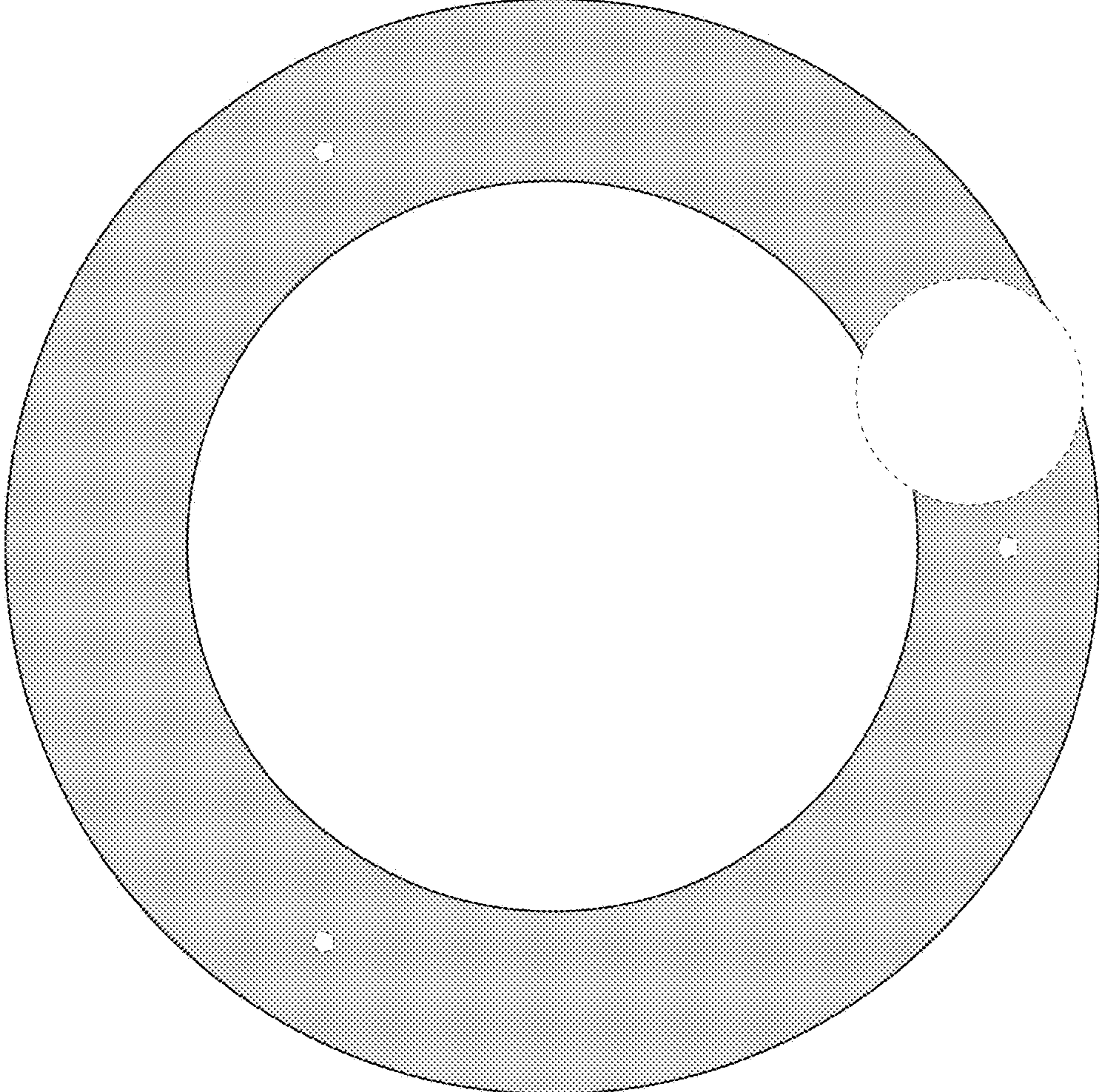

FIG. 8

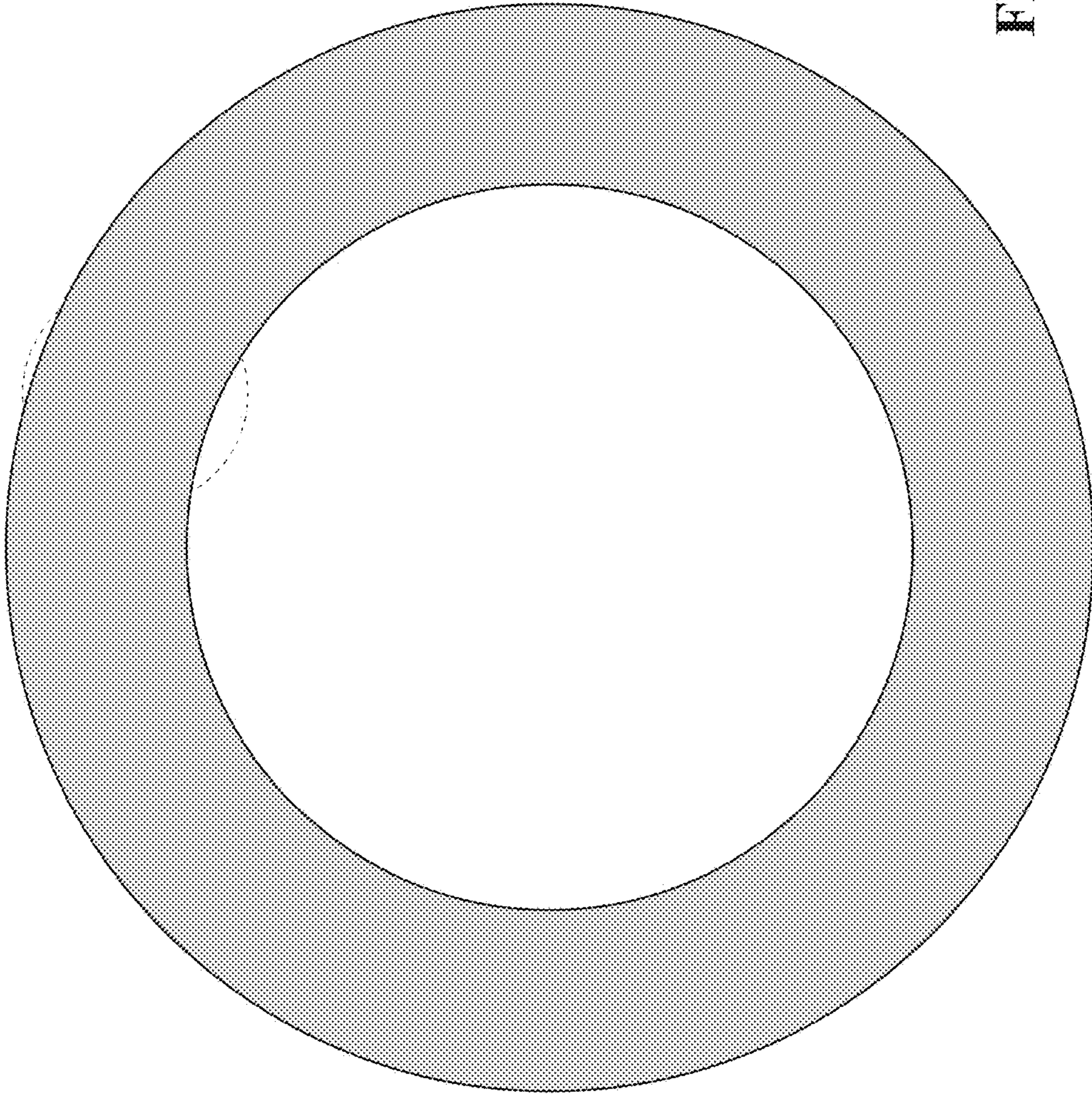

FIG. 9

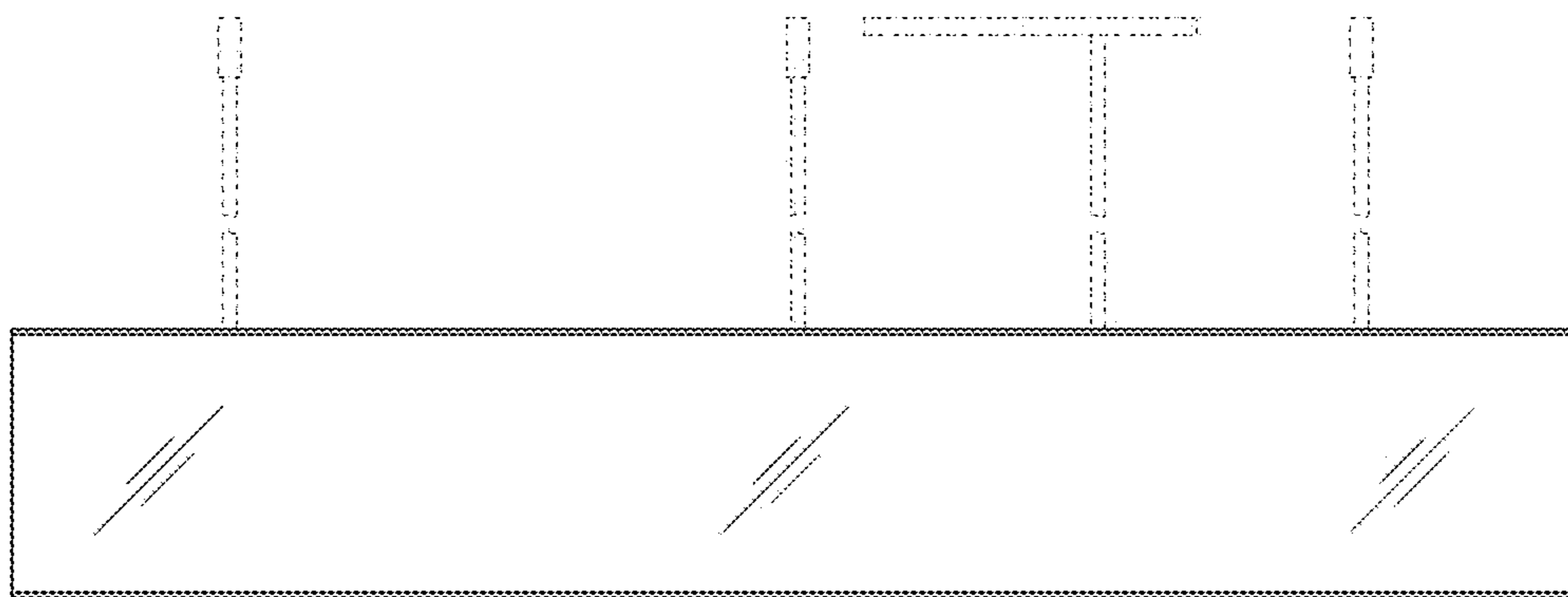

FIG. 10

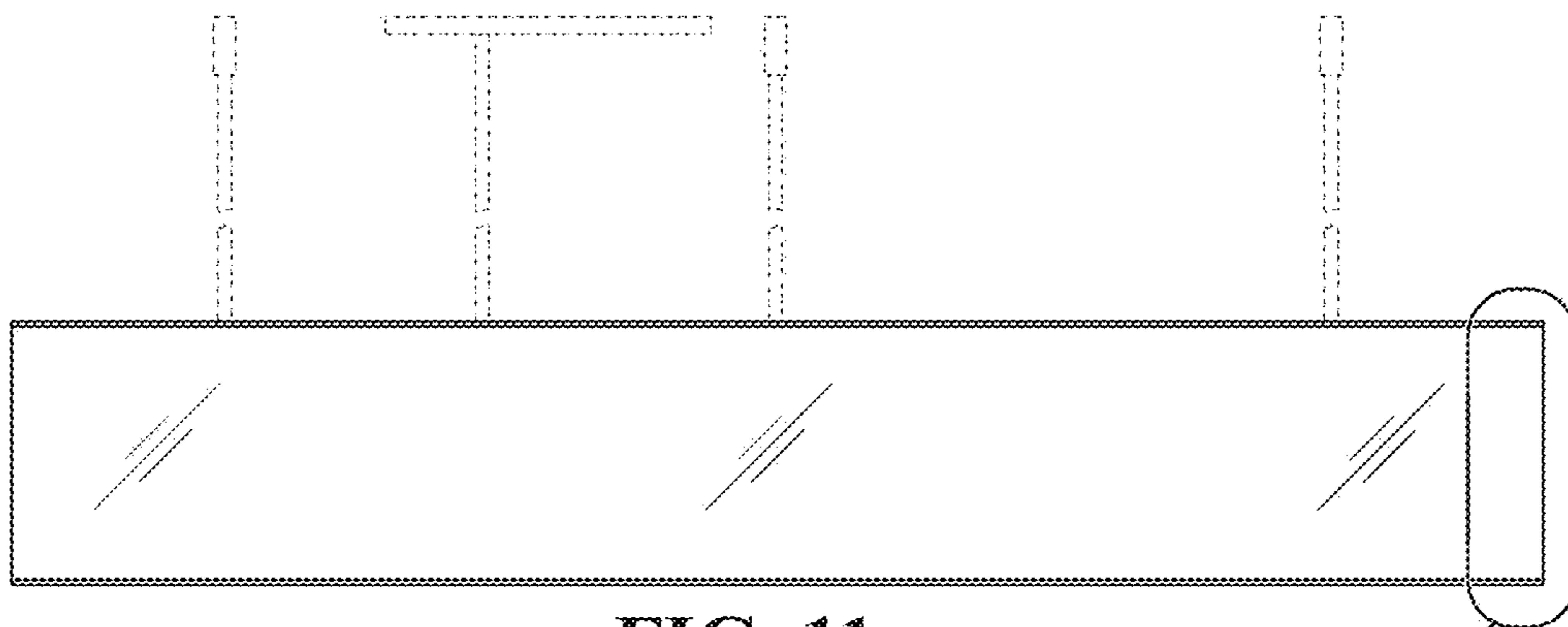

FIG. 11

FIG. 12

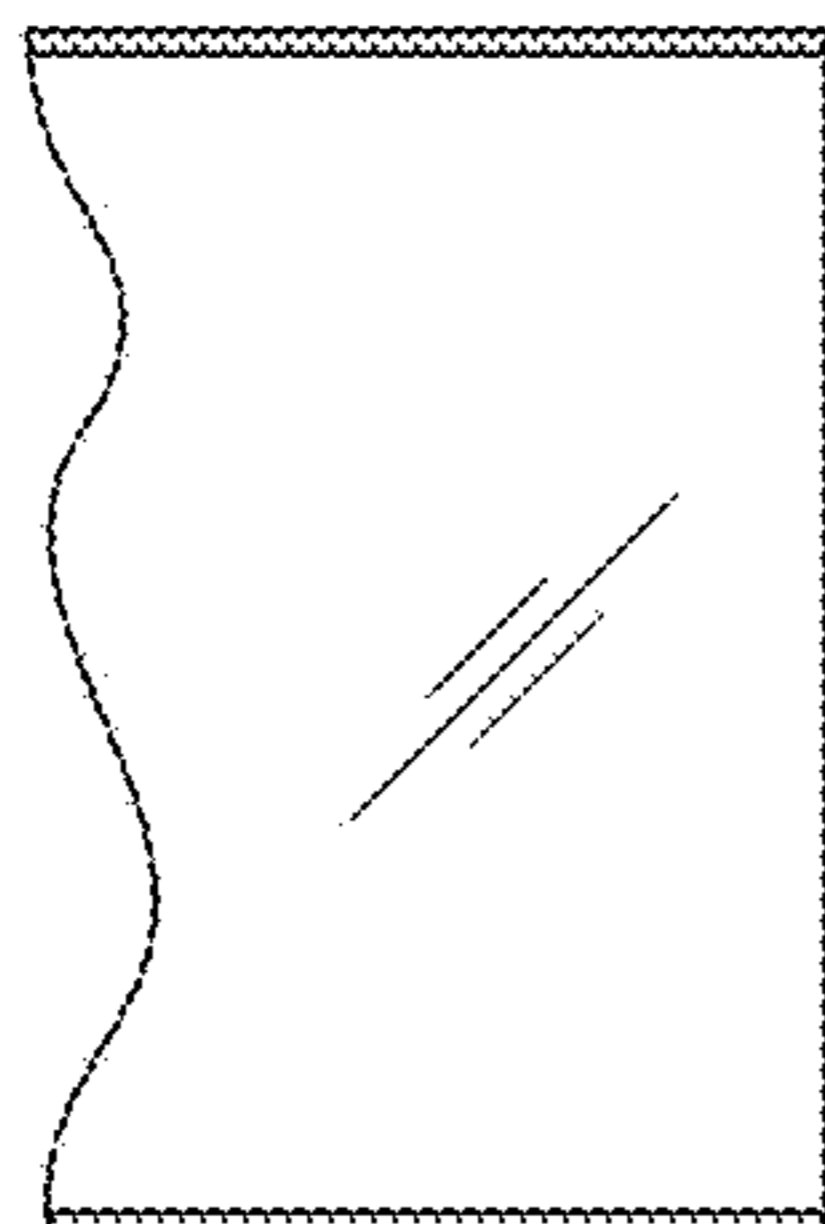

FIG. 12

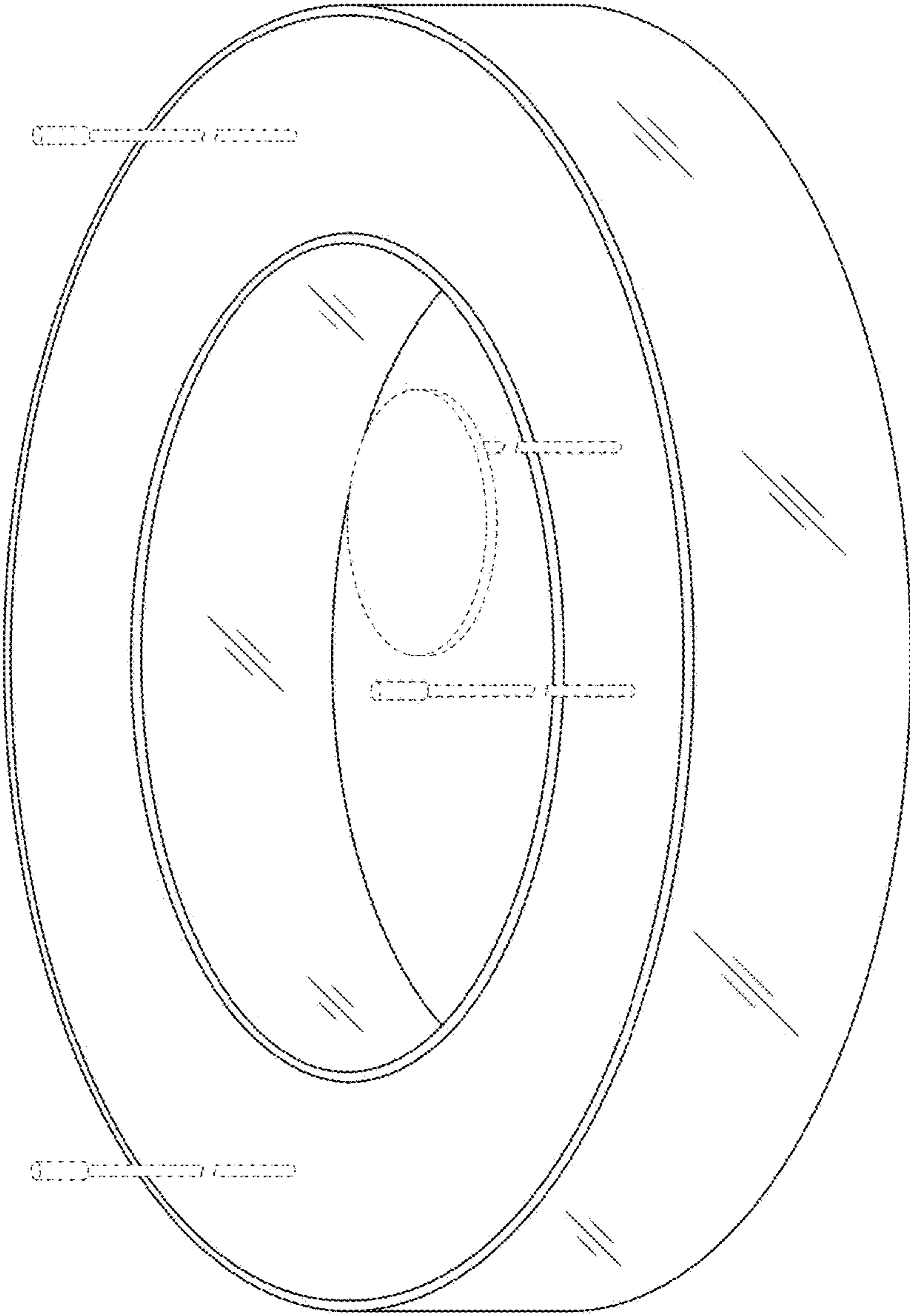

FIG. 13

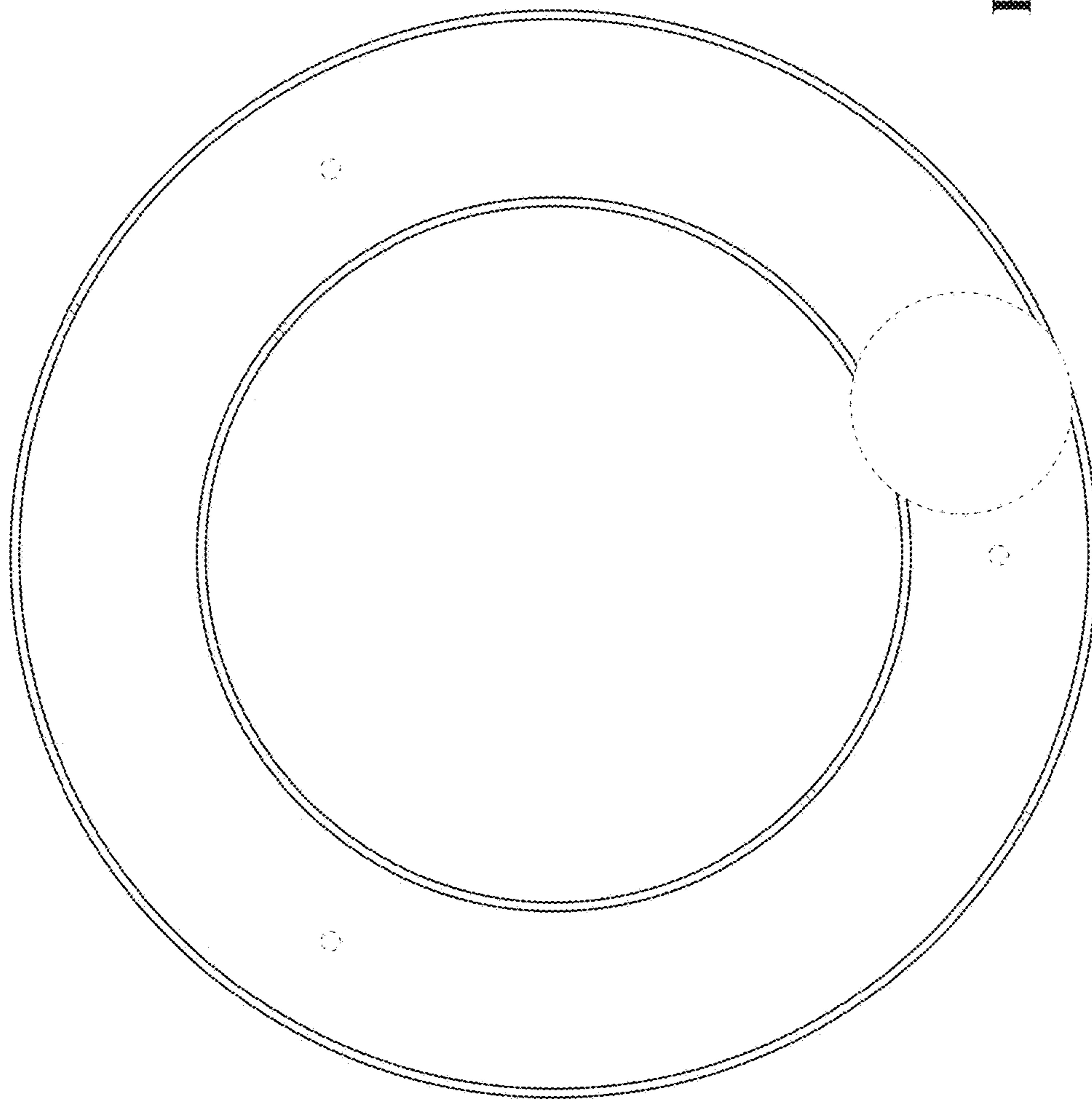

FIG. 14

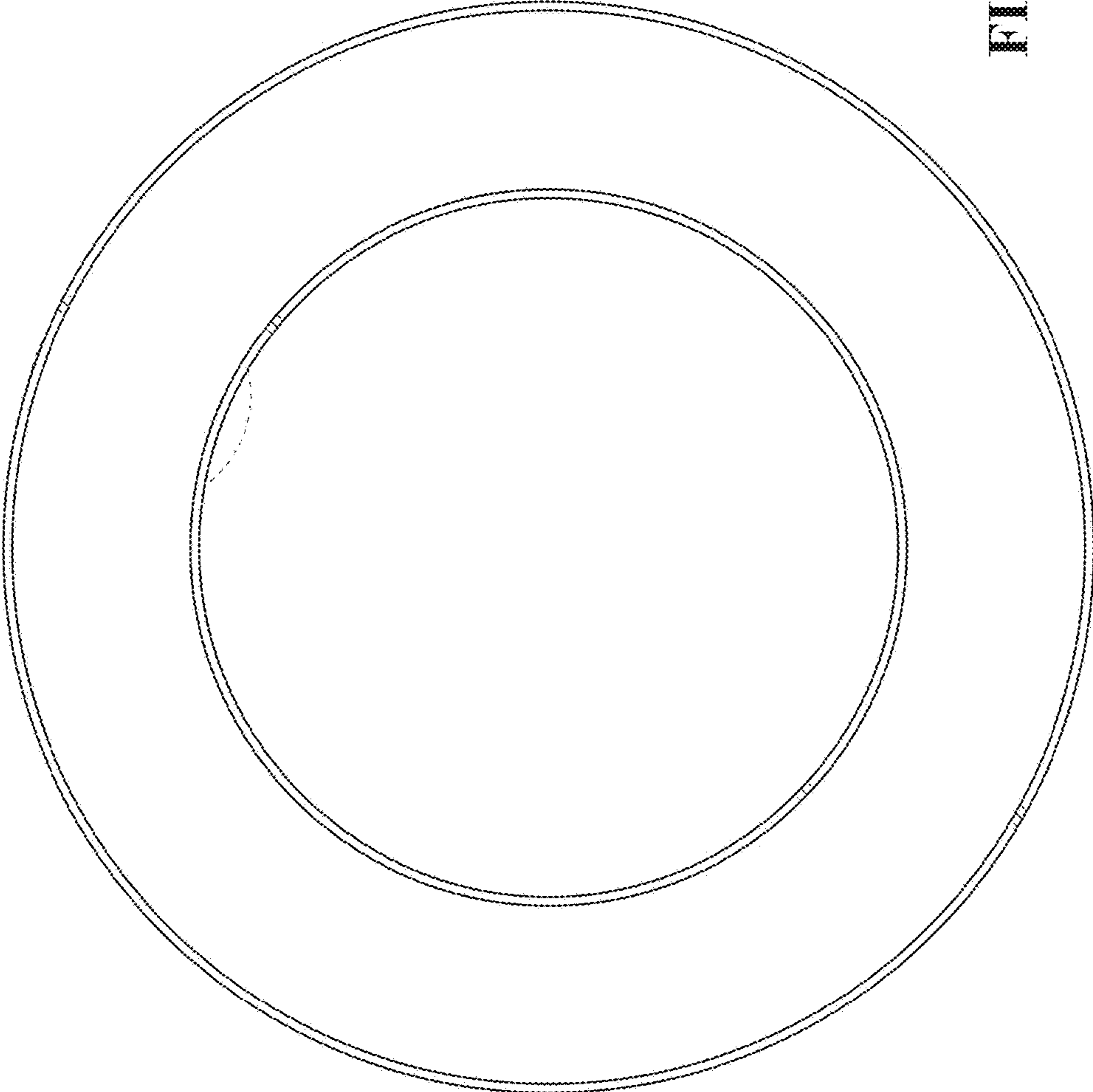

FIG. 15

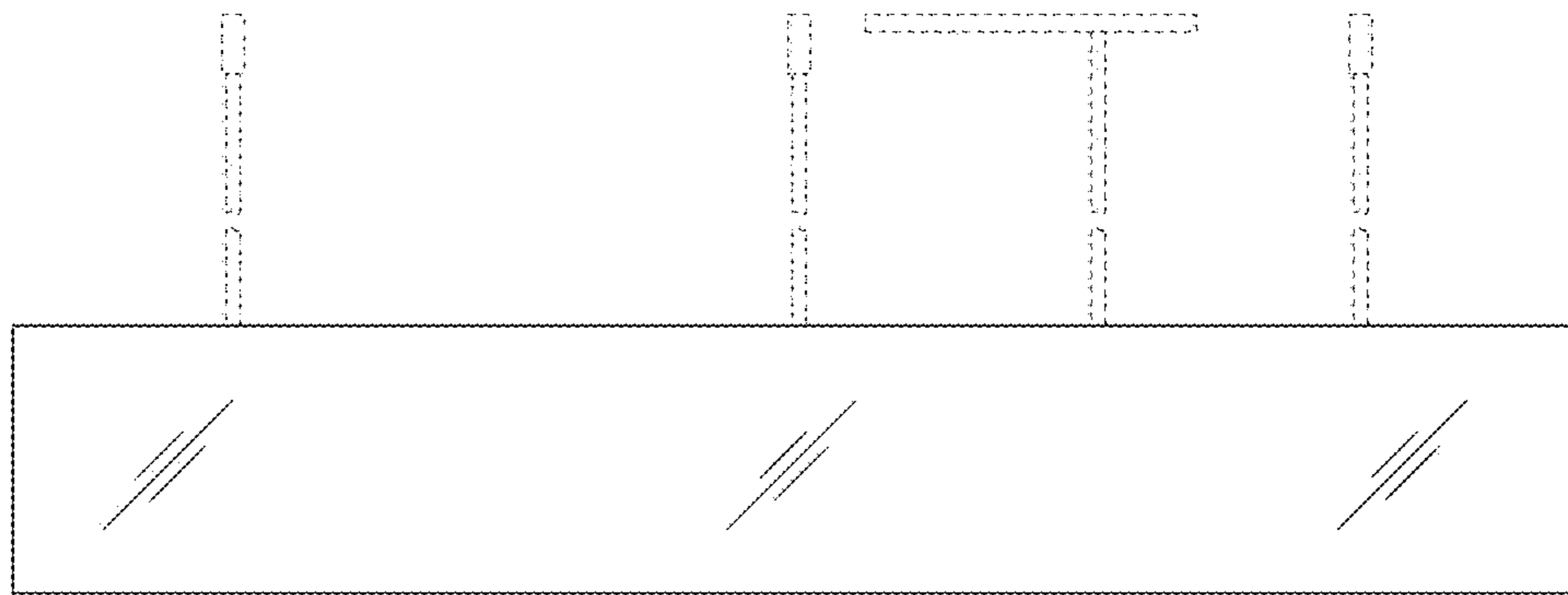

FIG. 16

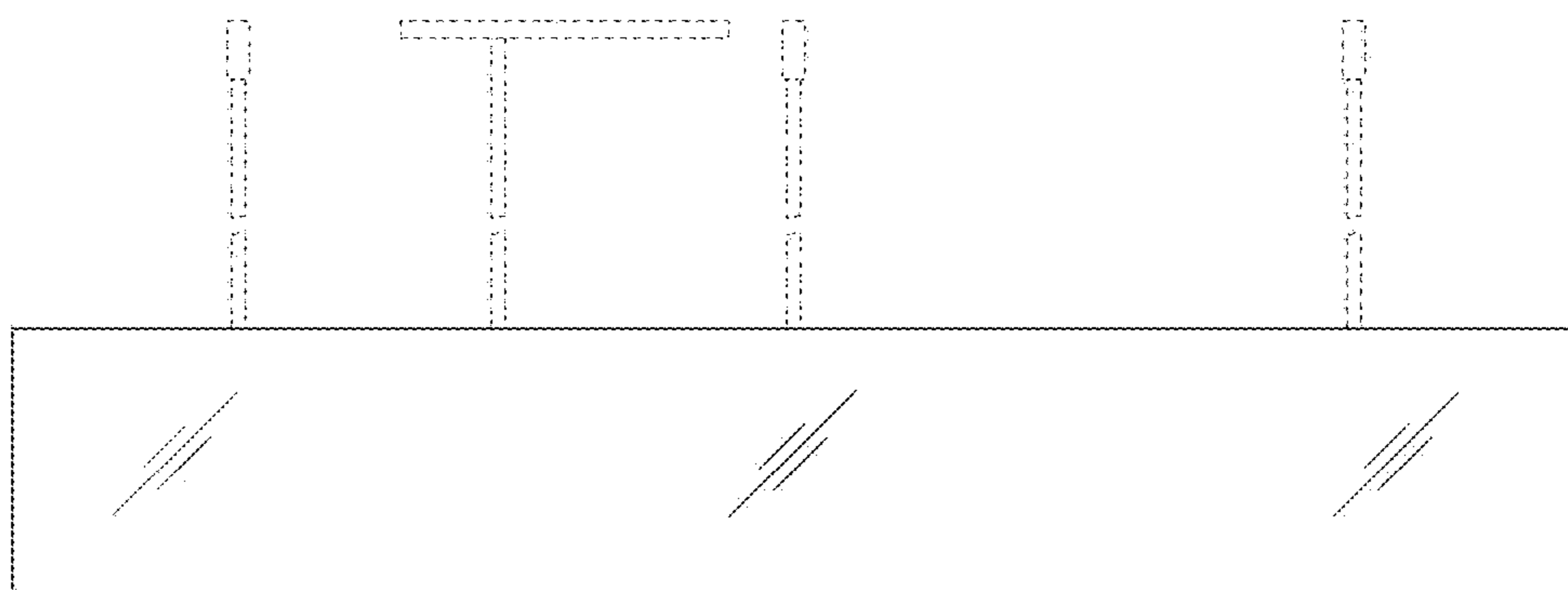

FIG. 17

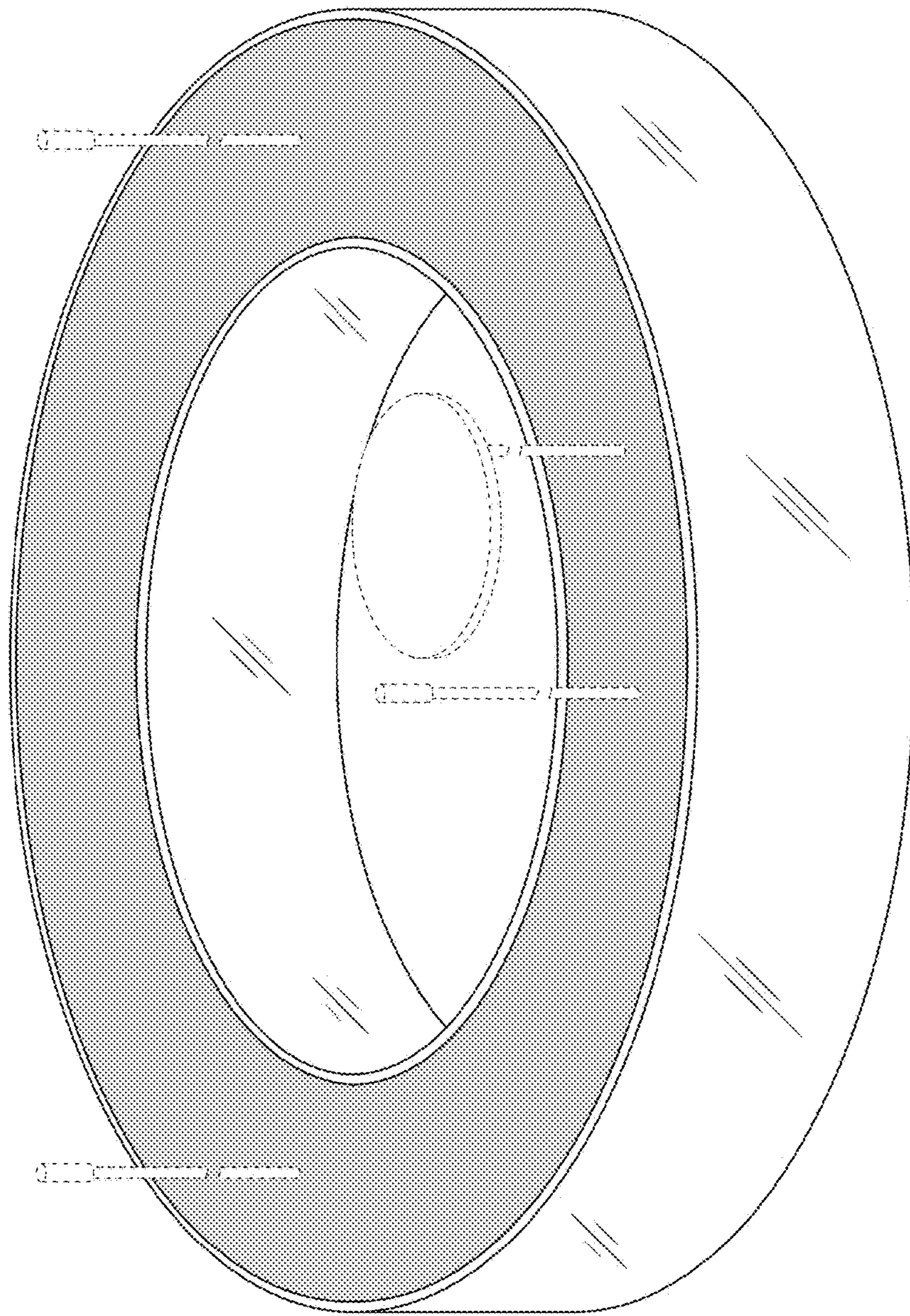

FIG. 18

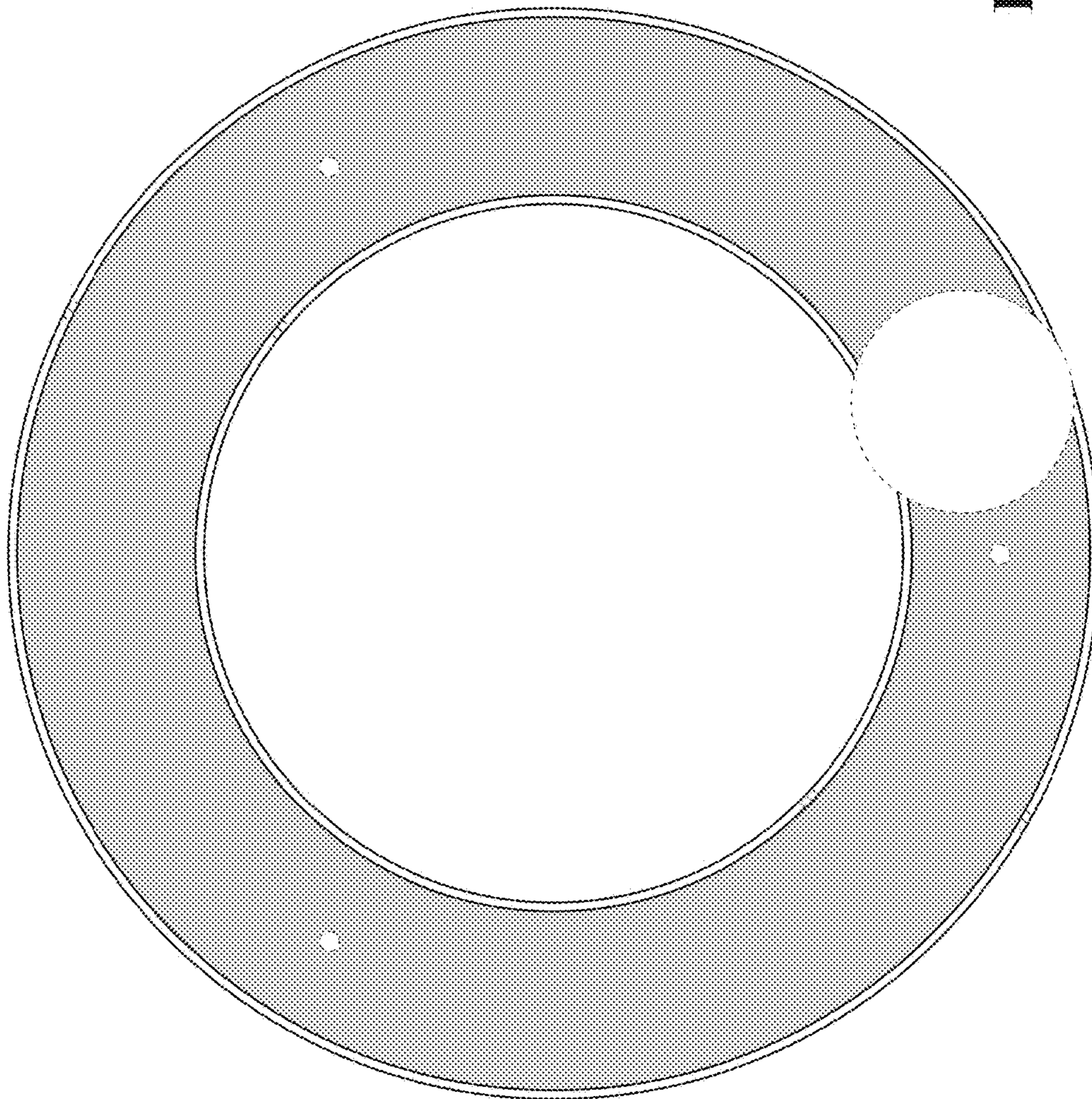

FIG. 19

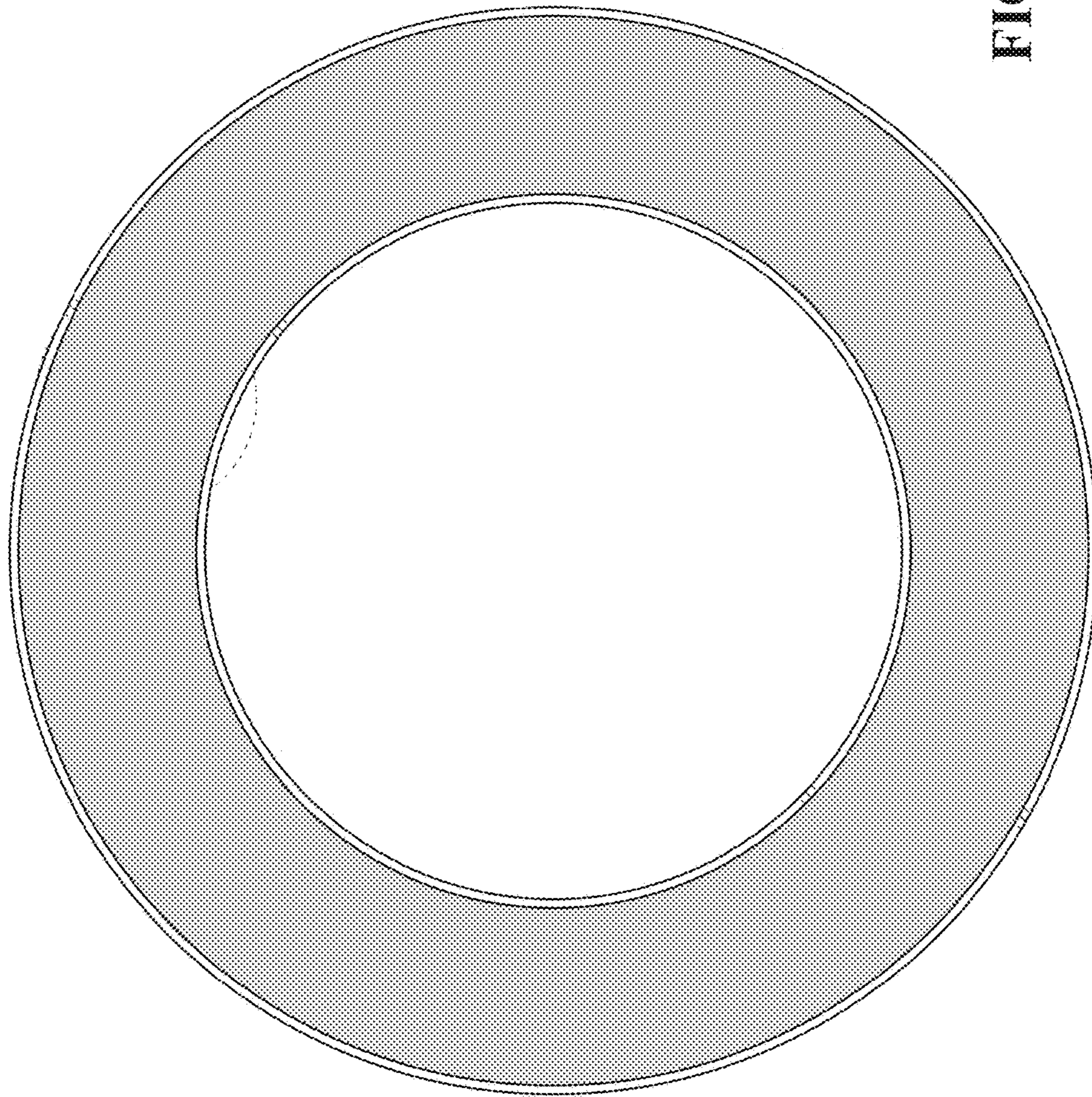

FIG. 20

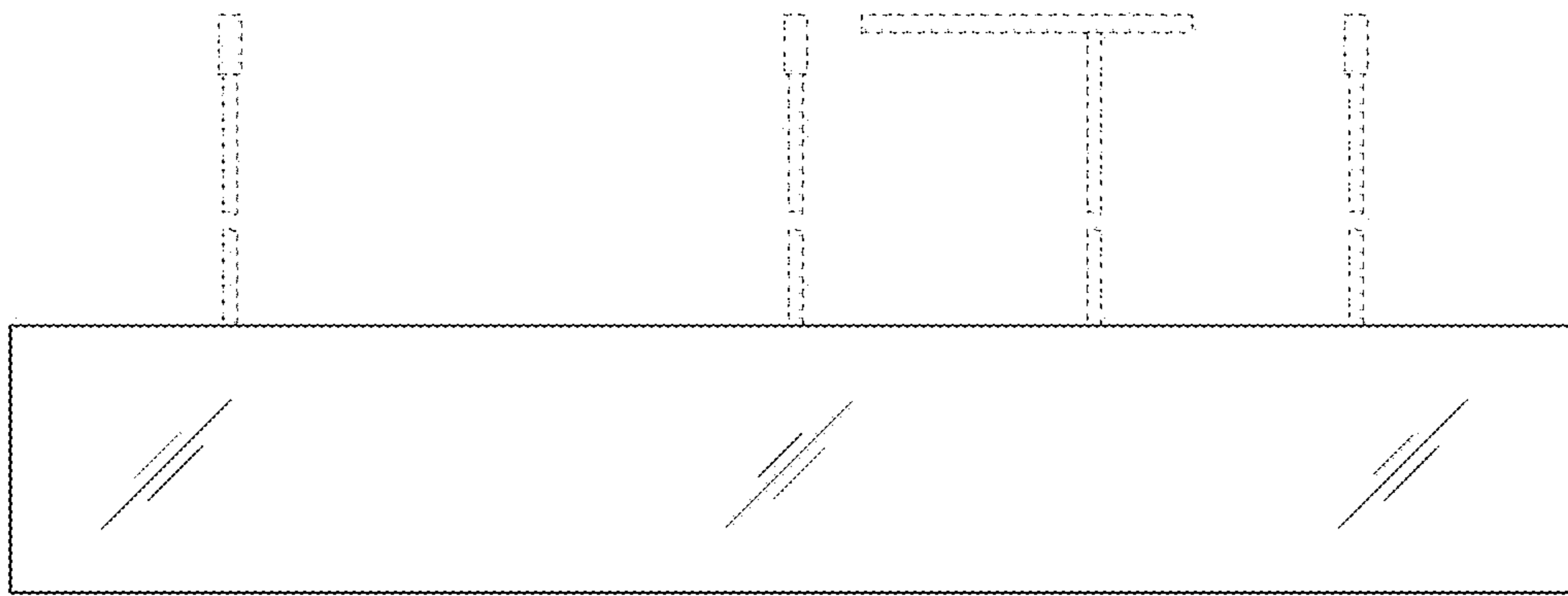

FIG. 21

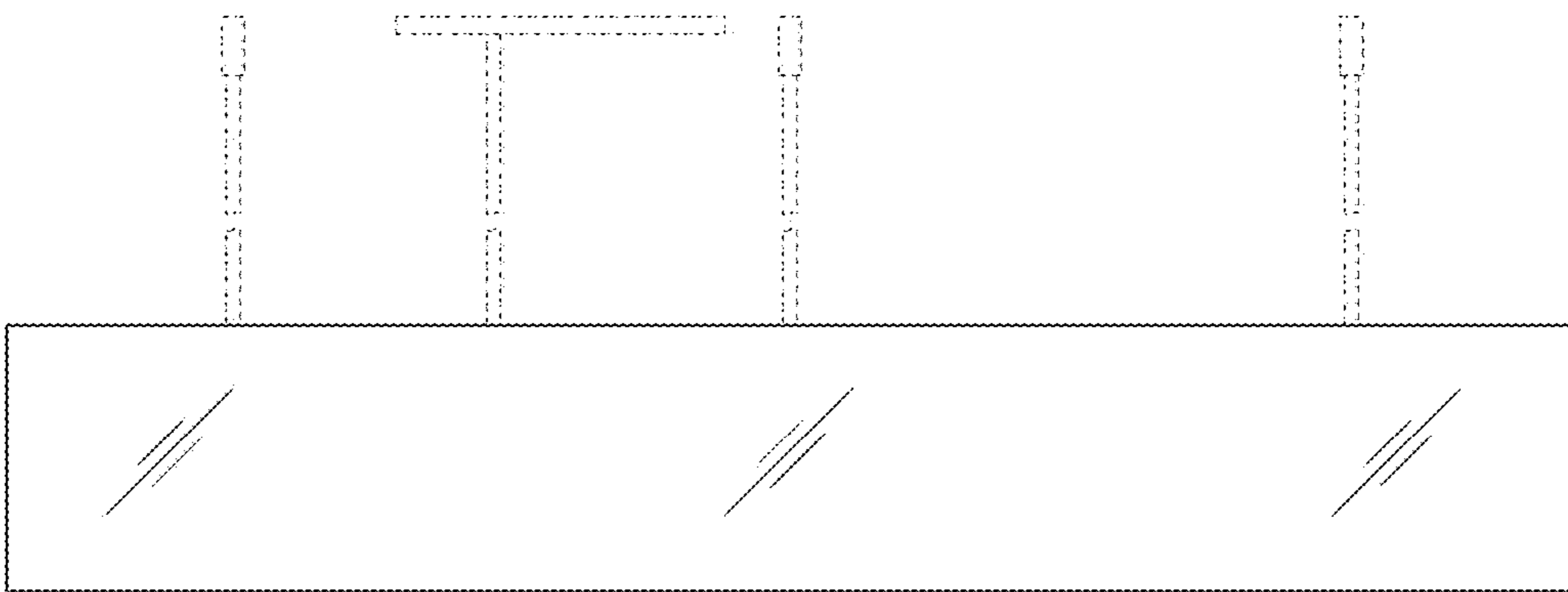

FIG. 22

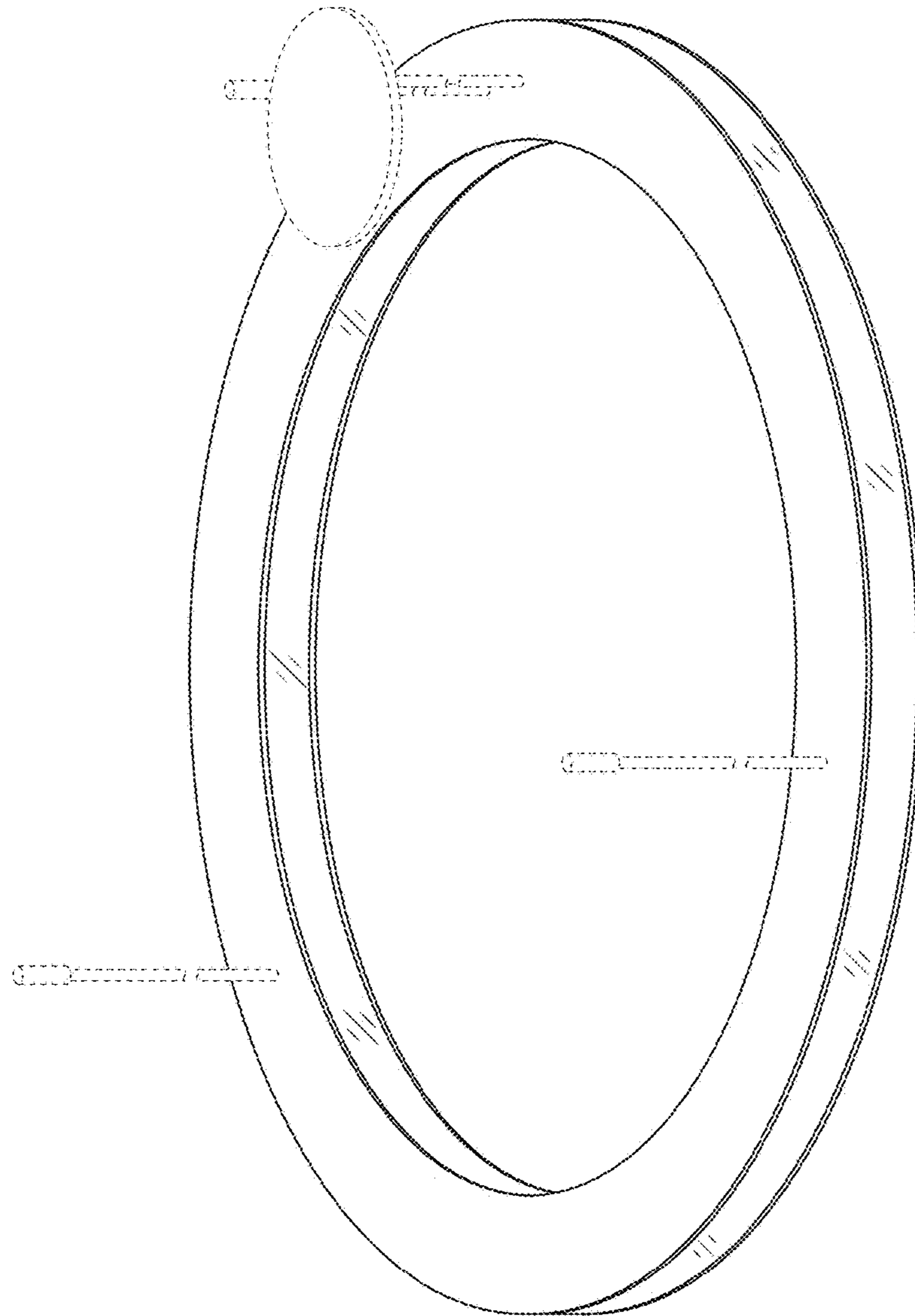

FIG. 23

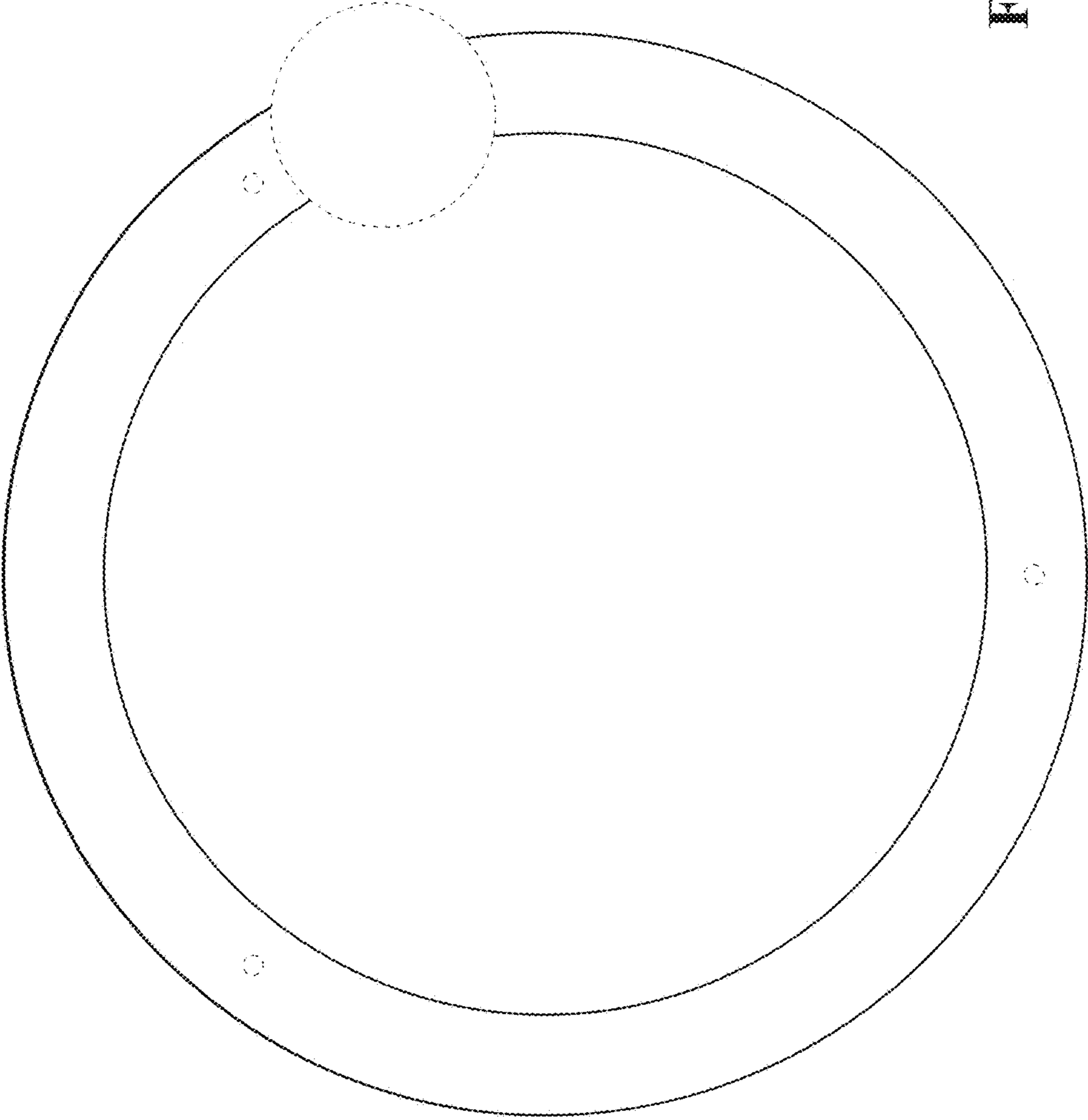

FIG. 24

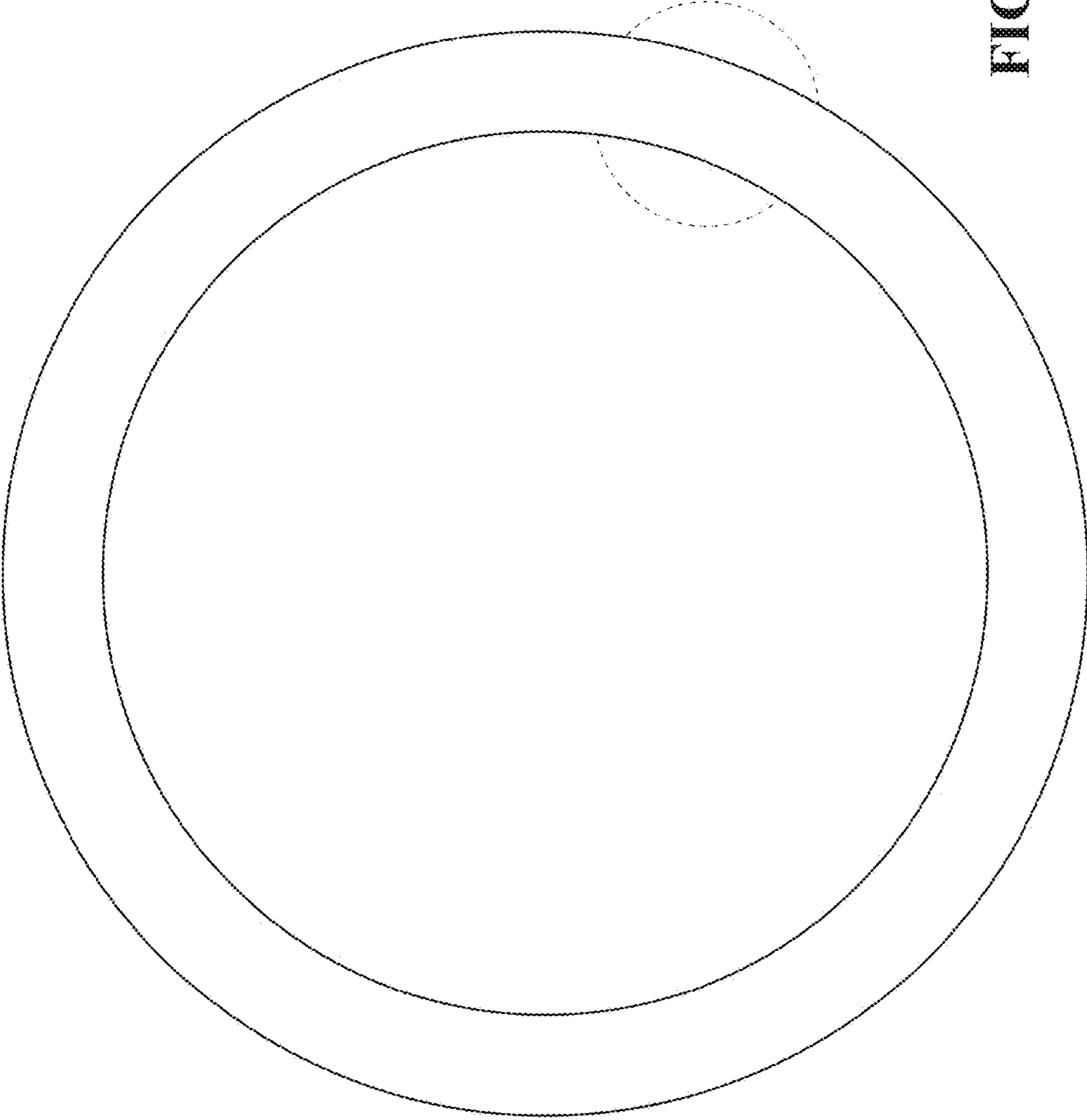

FIG. 25

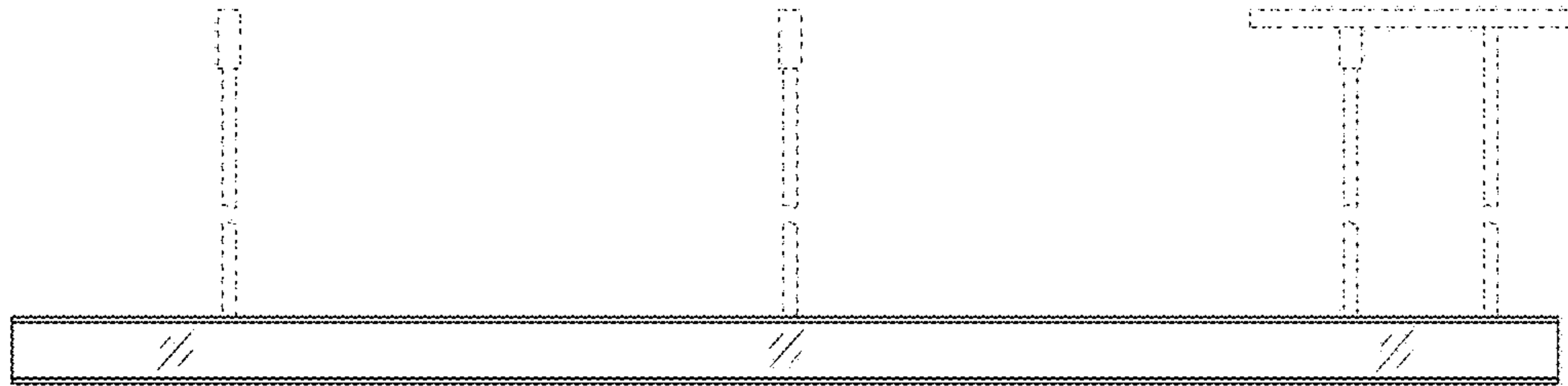

FIG. 26

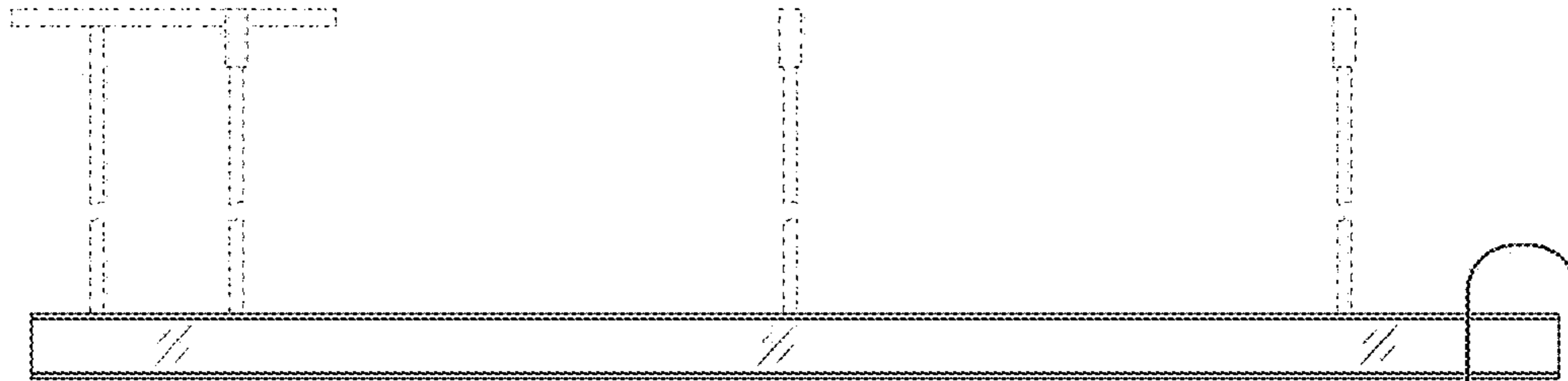

FIG. 27

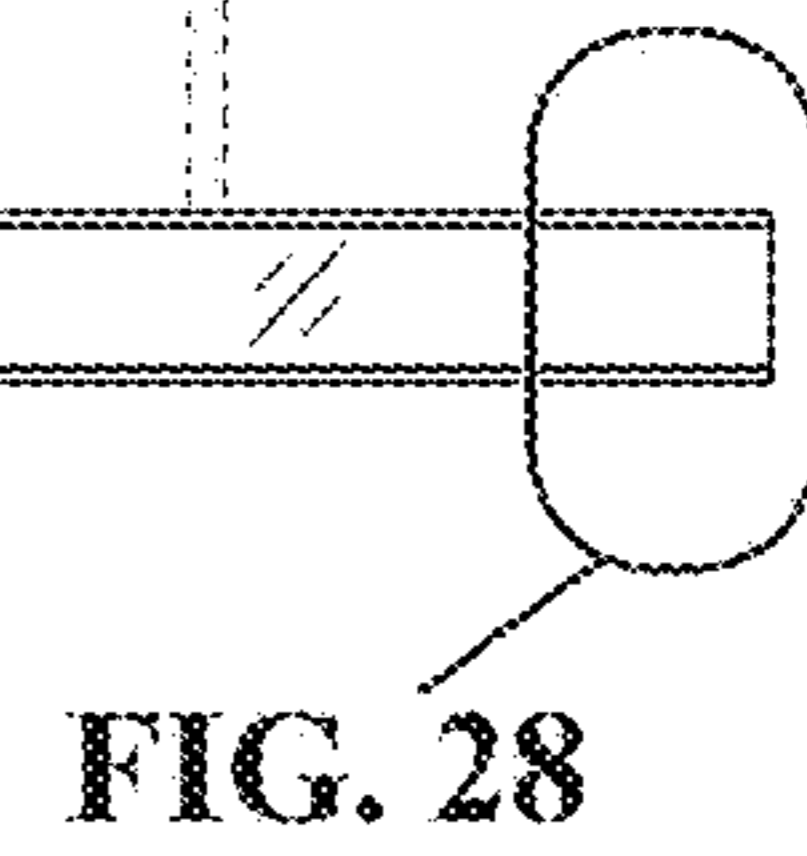

FIG. 28

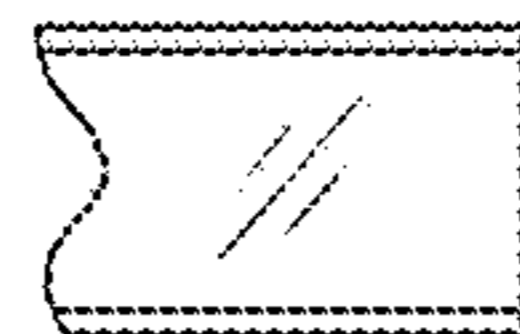

FIG. 28

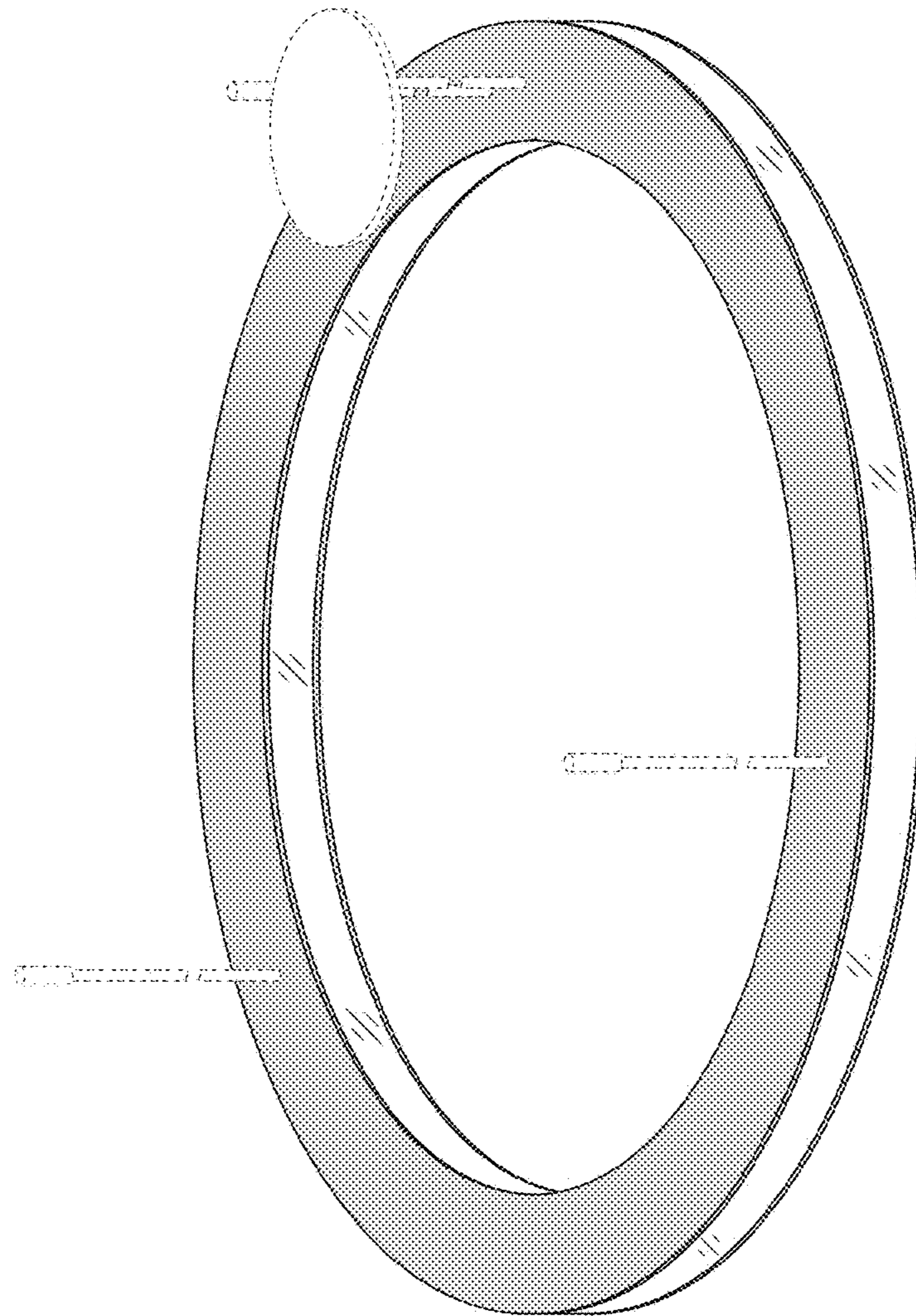

FIG. 29

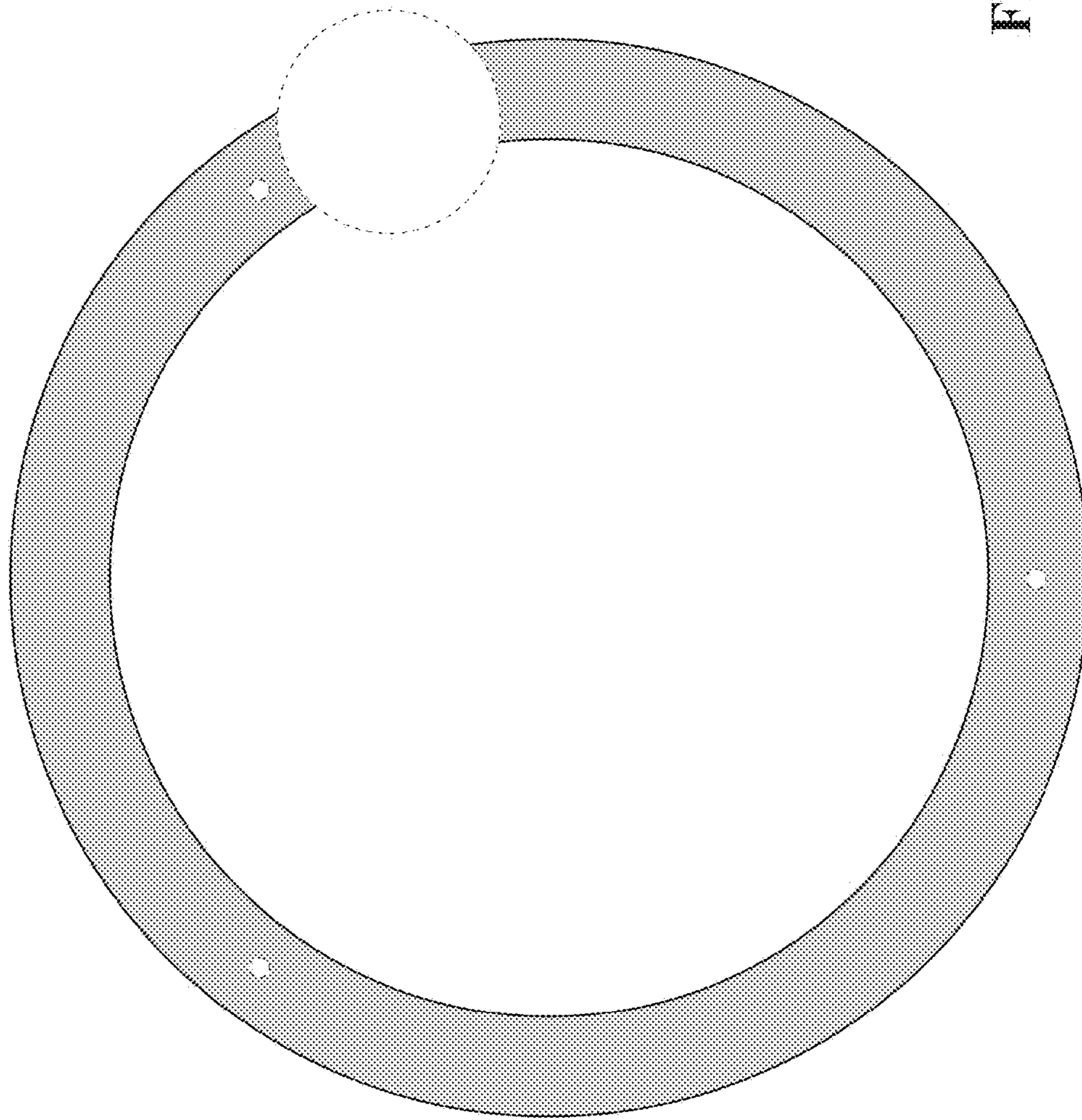

FIG. 30

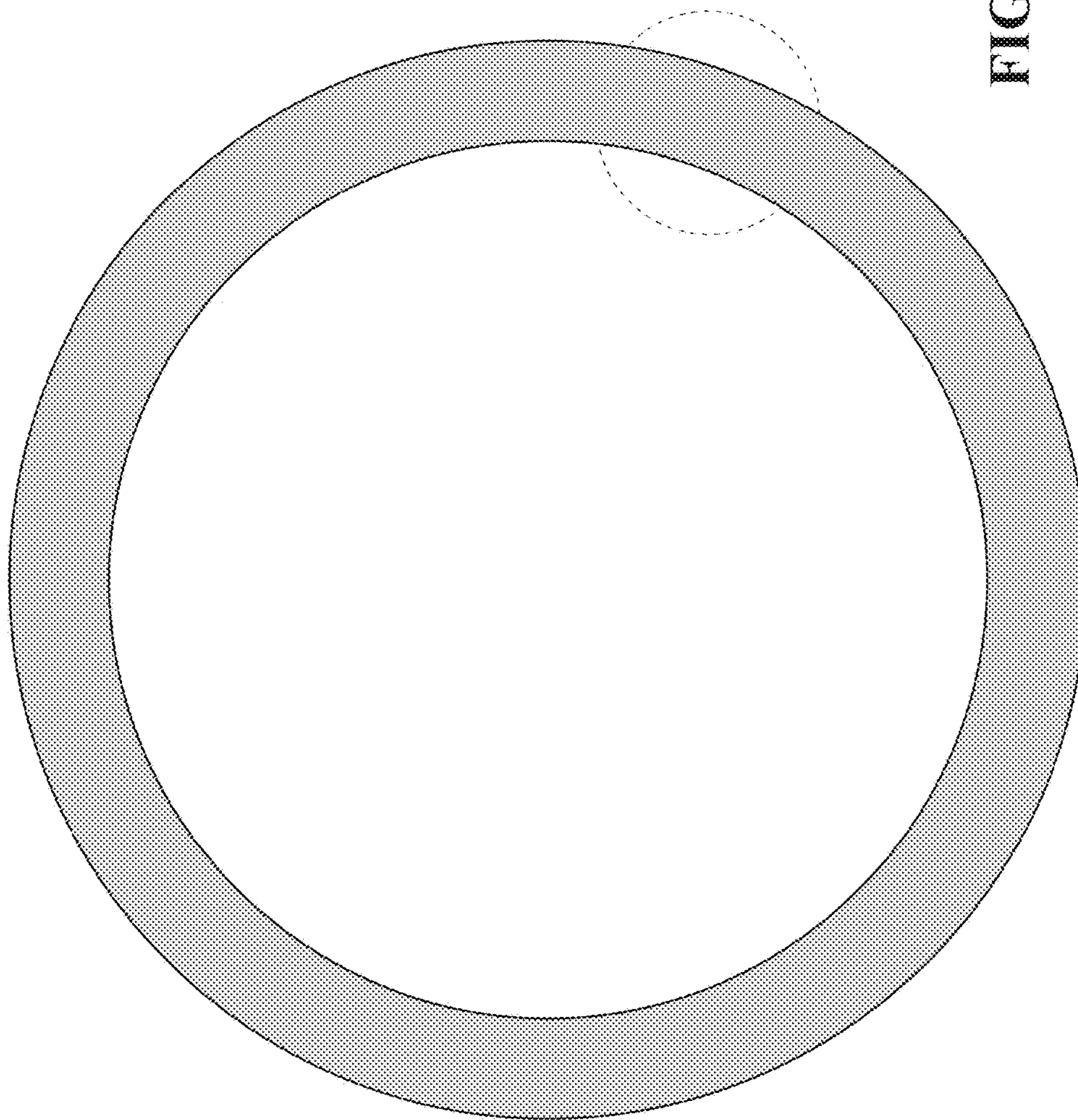

FIG. 31

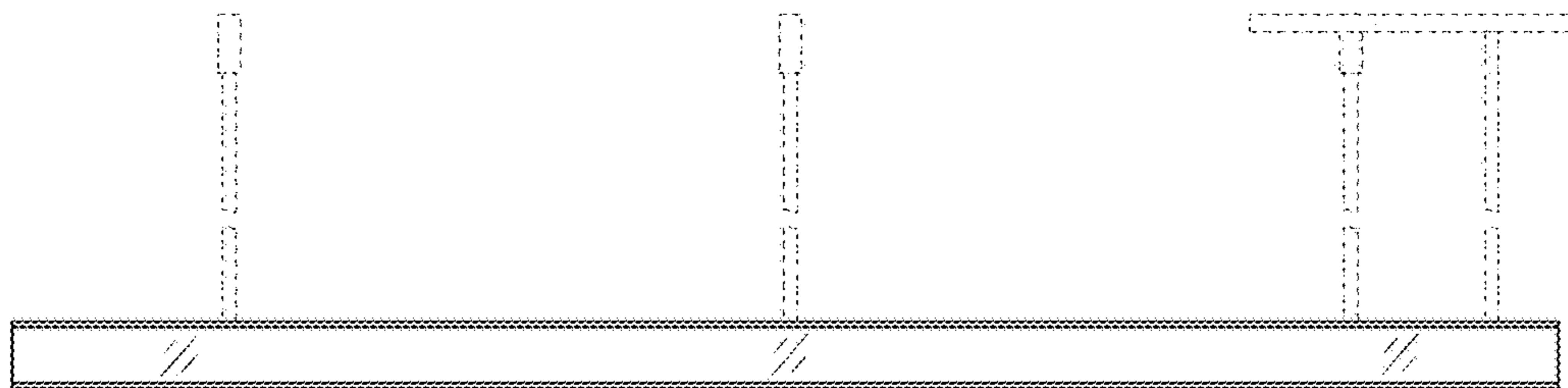

FIG. 32

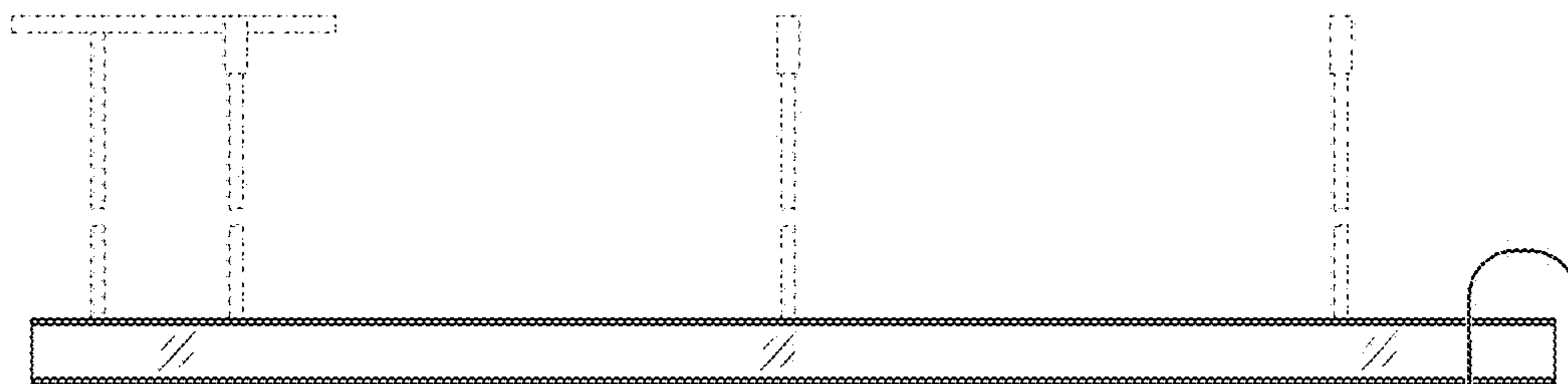

FIG. 33

FIG. 34



FIG. 34

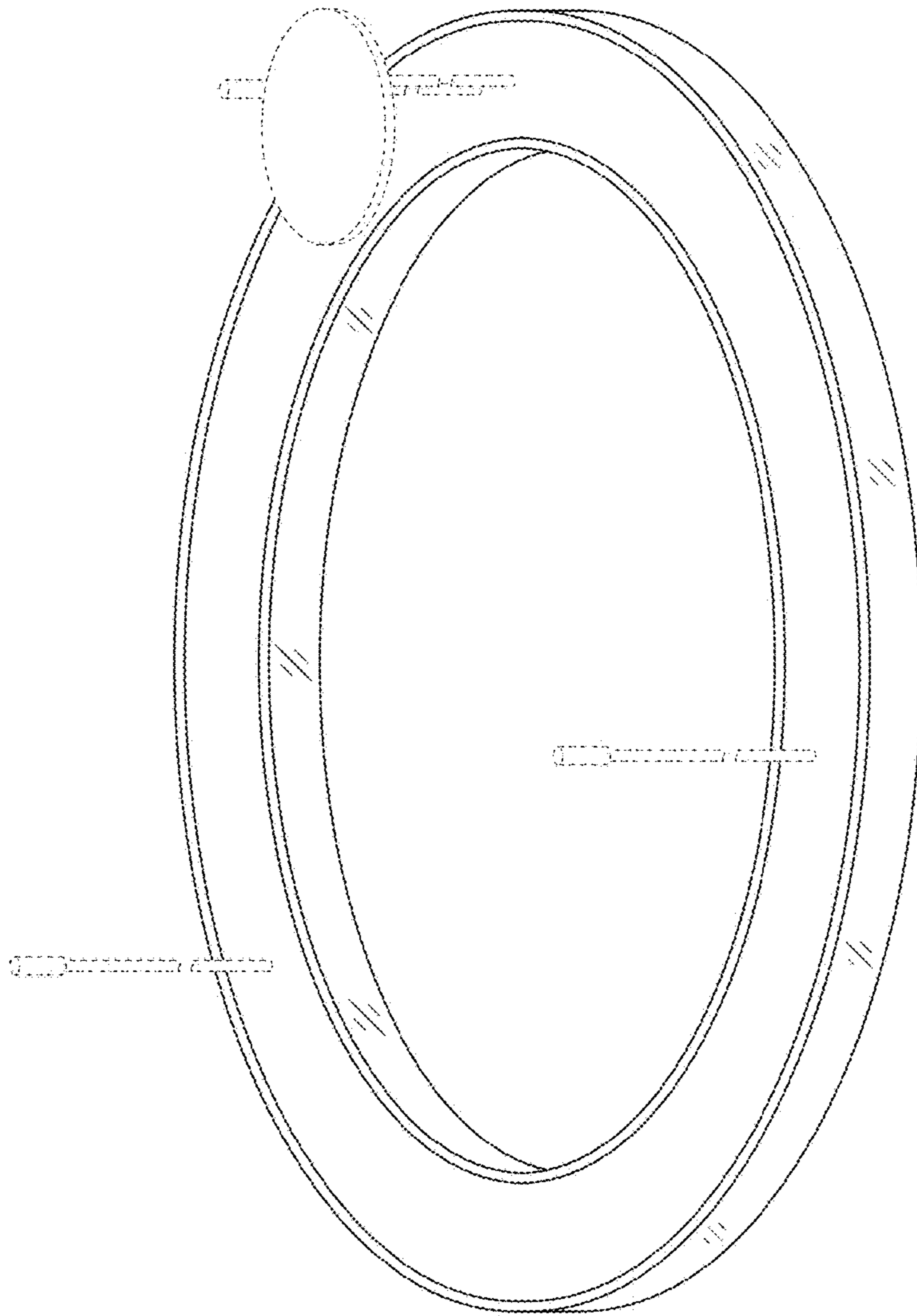

FIG. 35

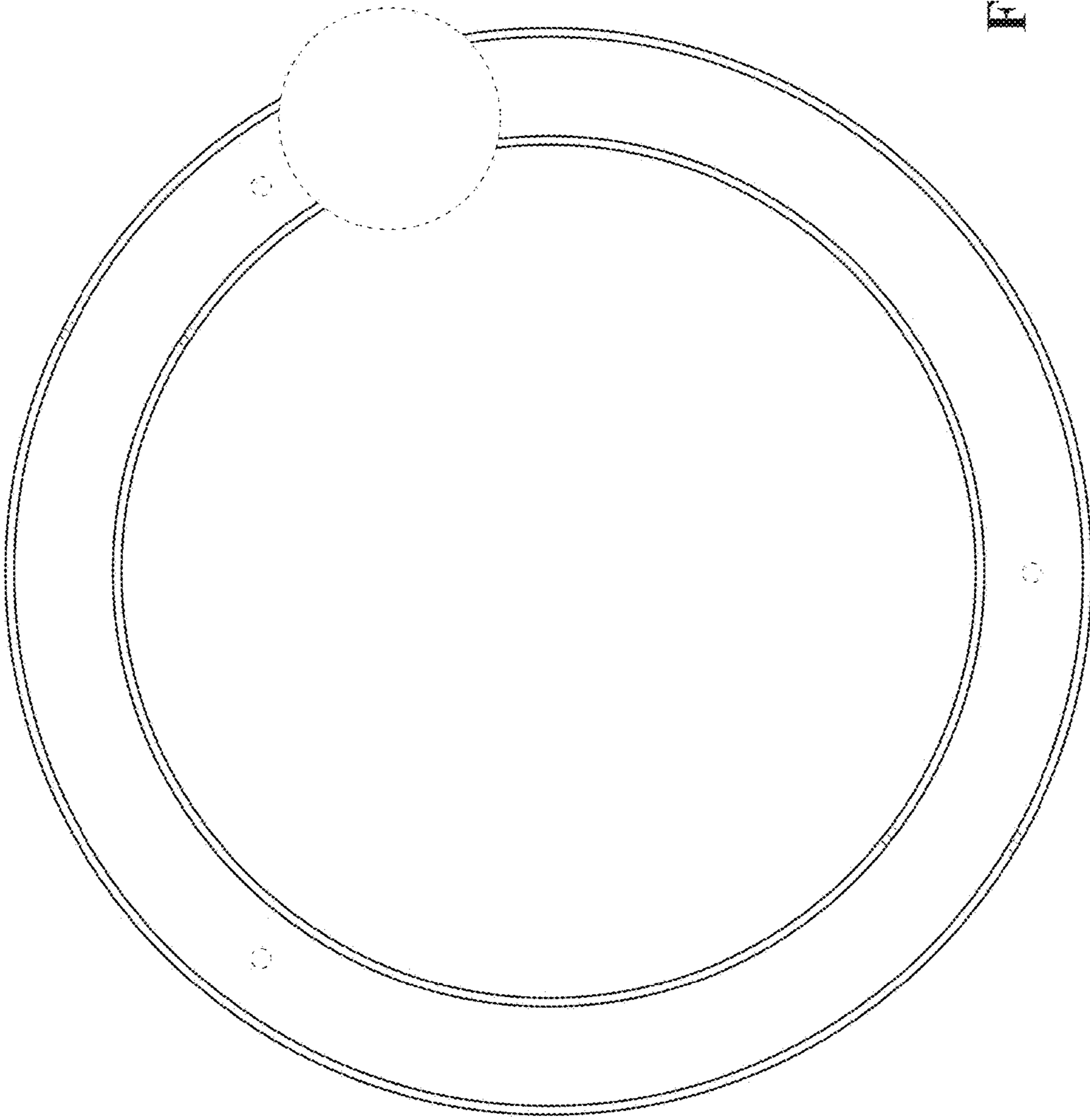

FIG. 36

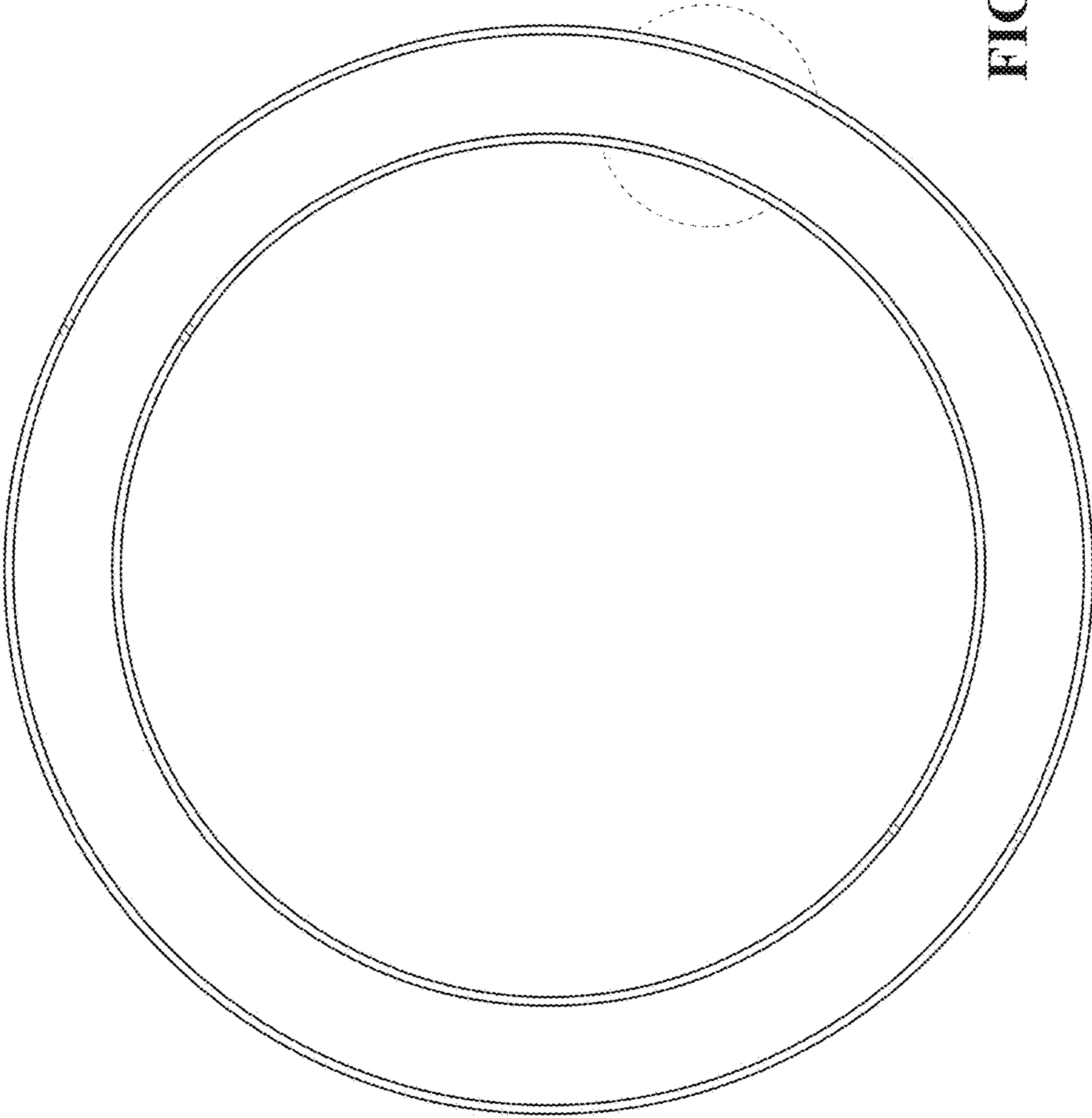

FIG. 37

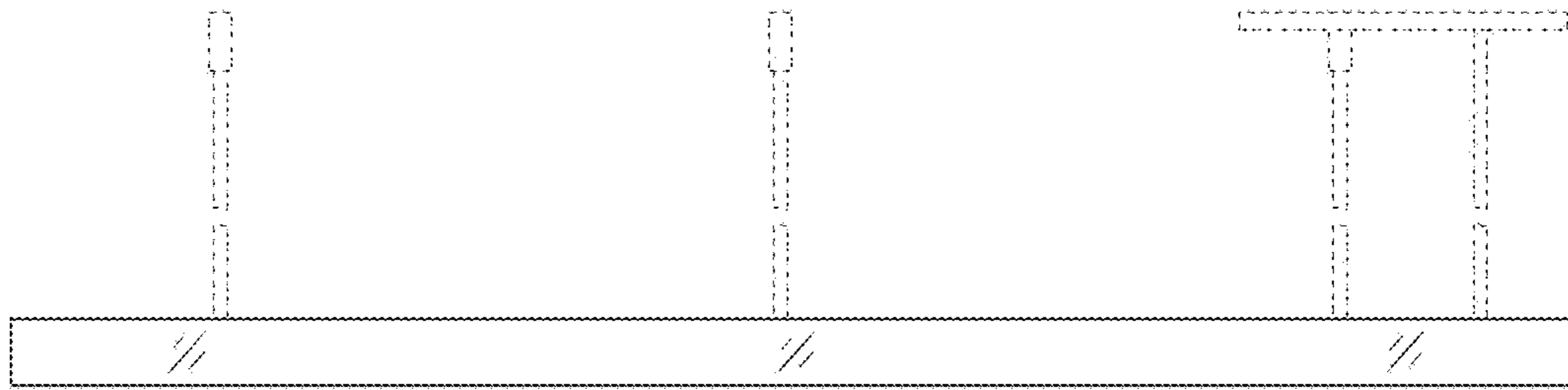

FIG. 38

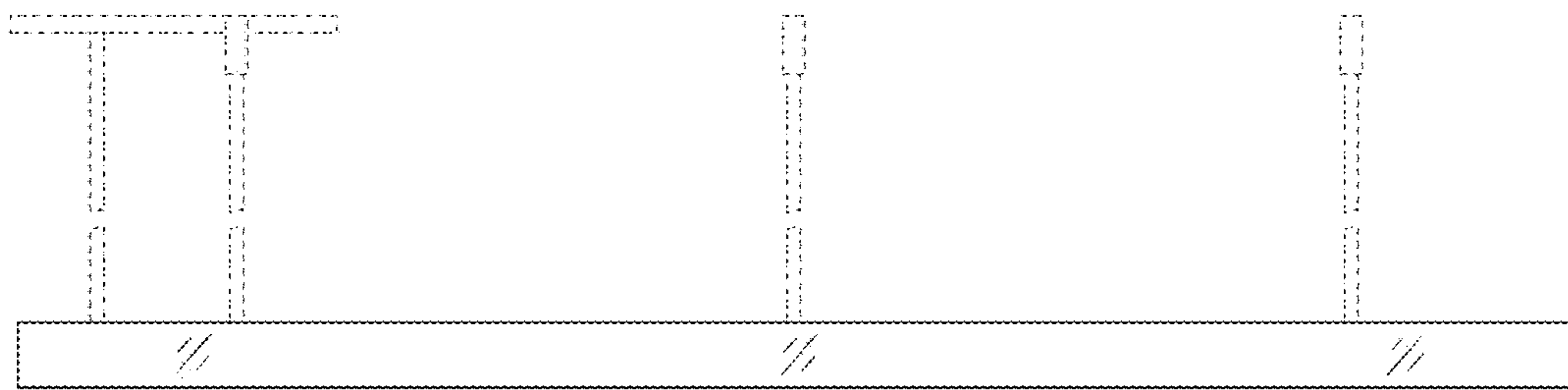

FIG. 39

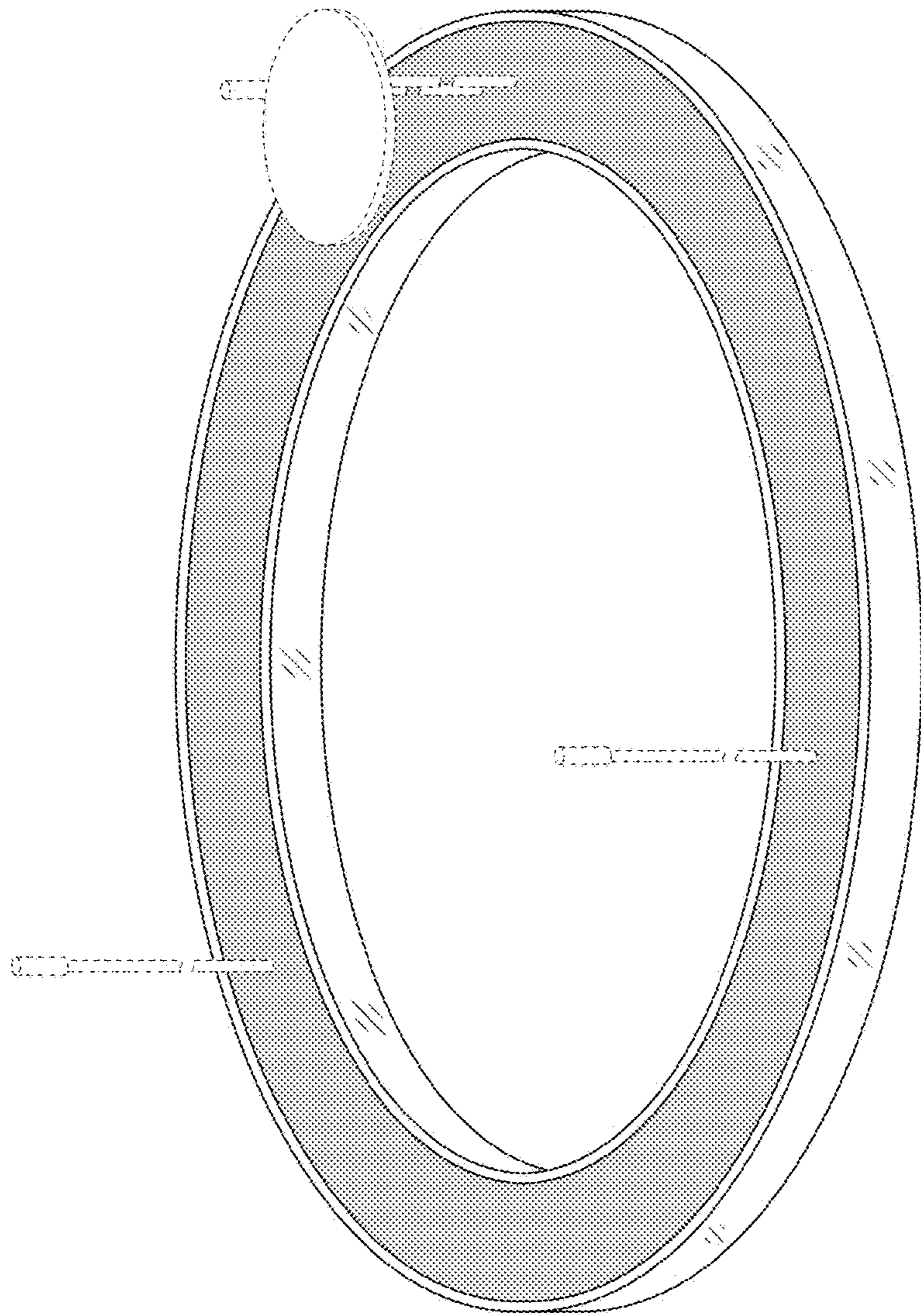

FIG. 40

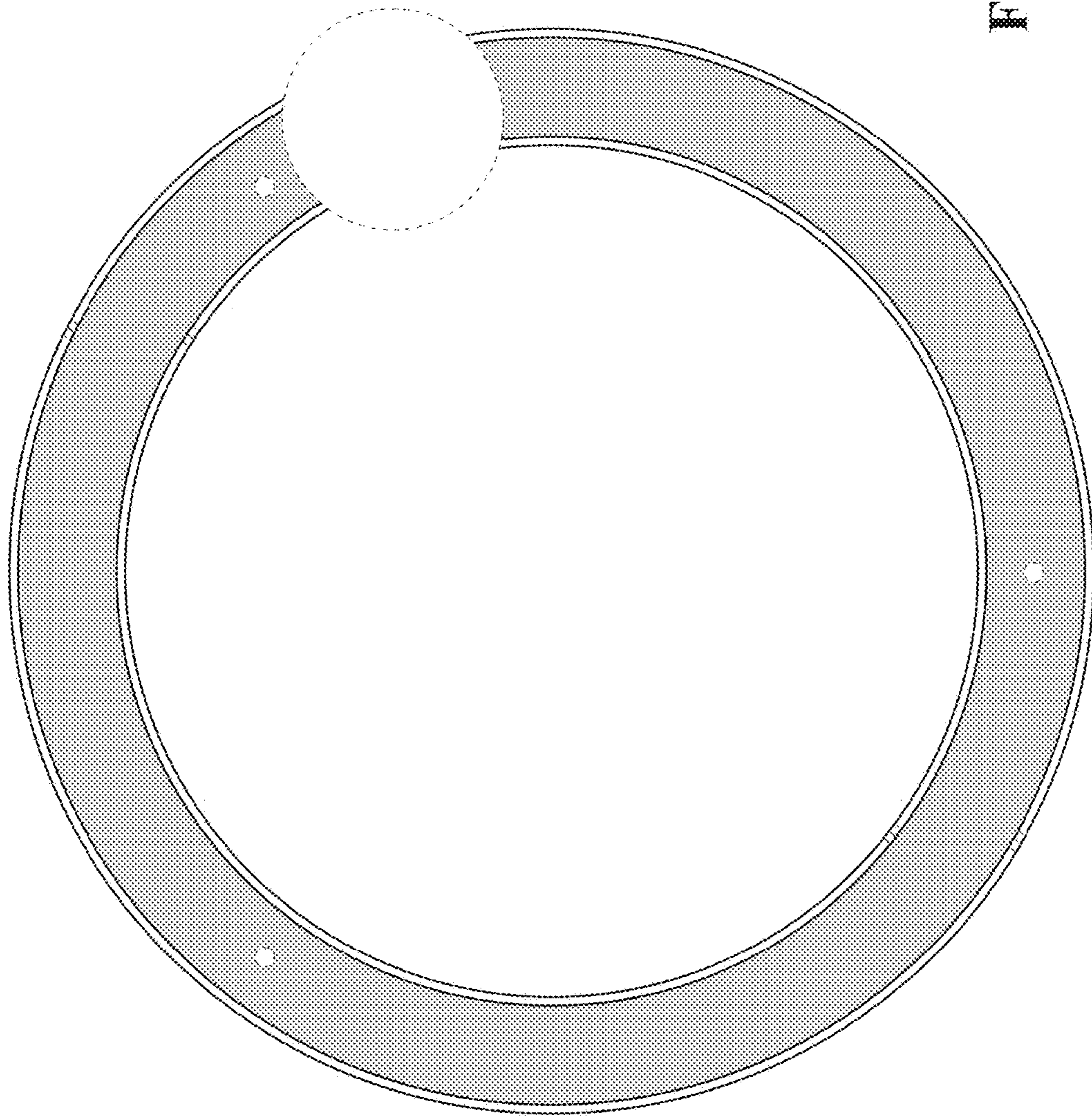

FIG. 41

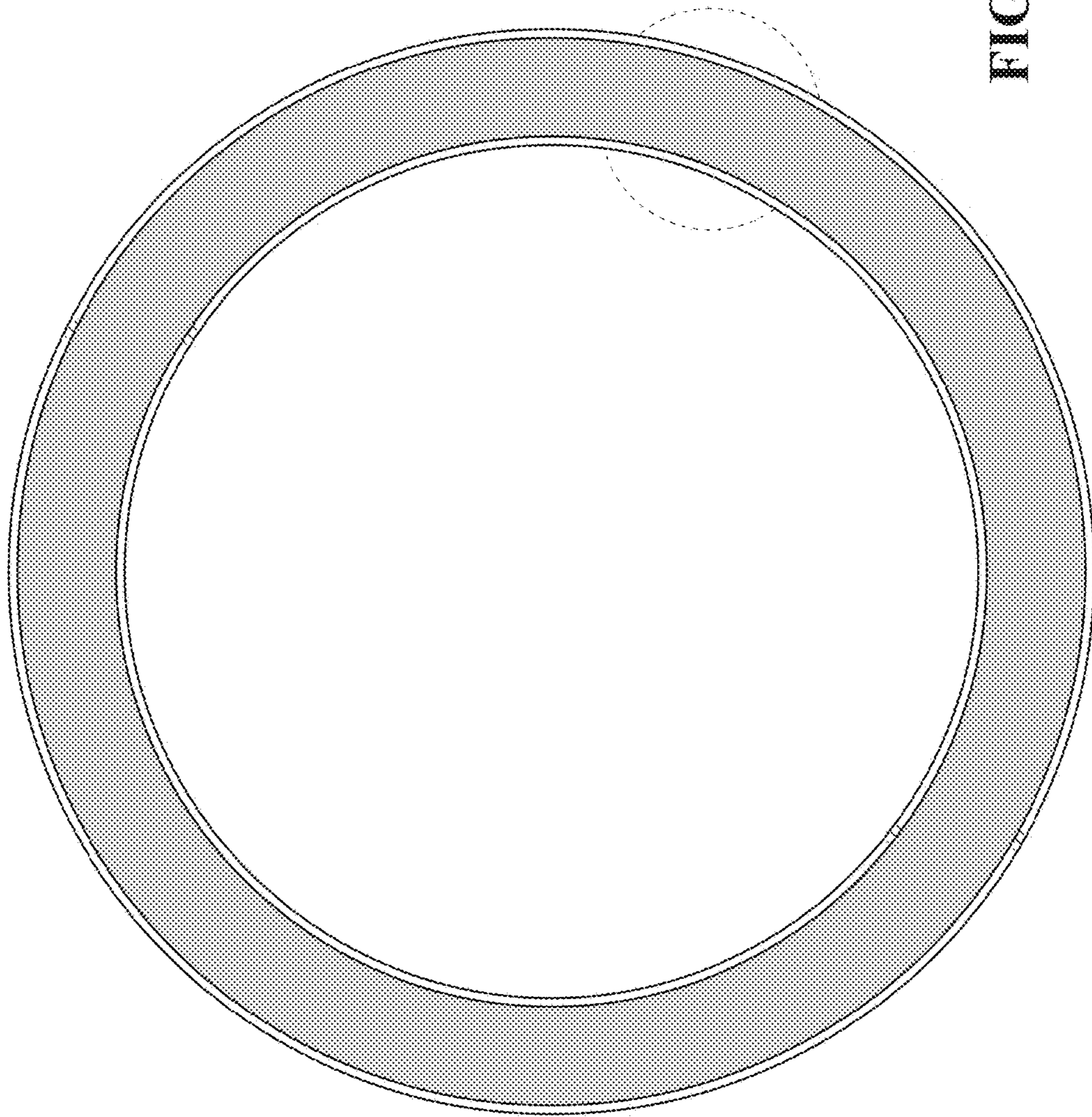

FIG. 42

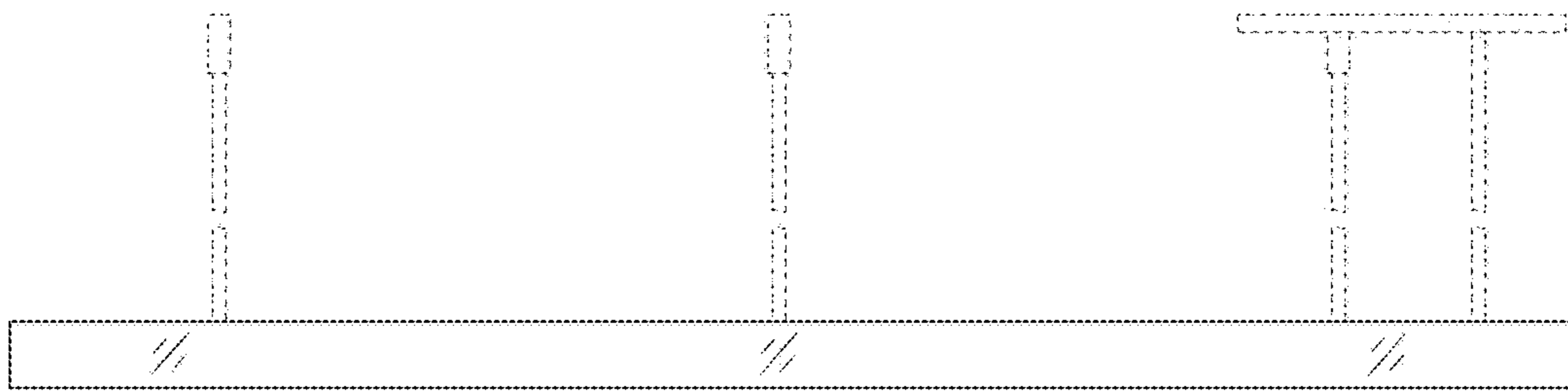

FIG. 43

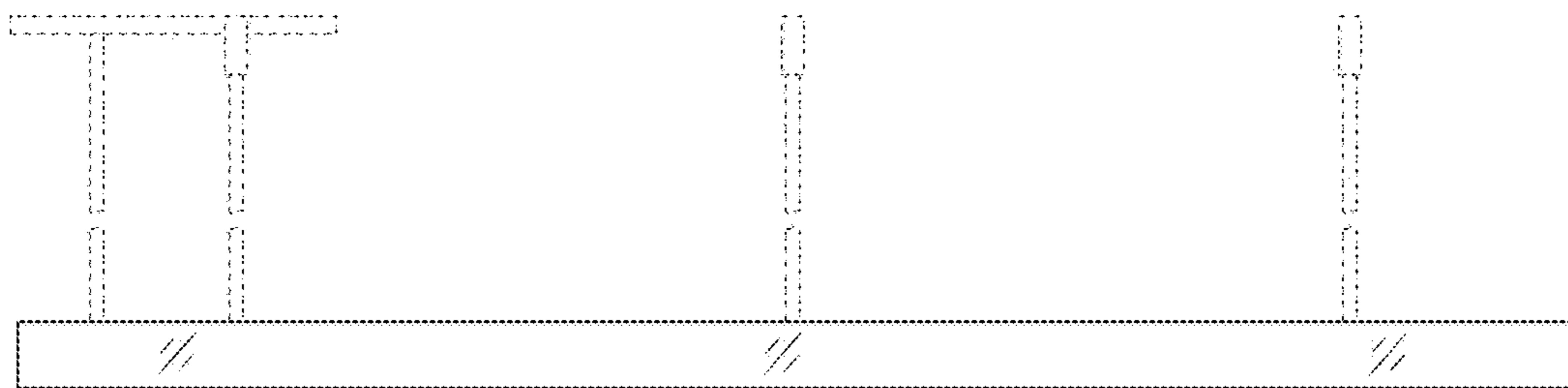

FIG. 44

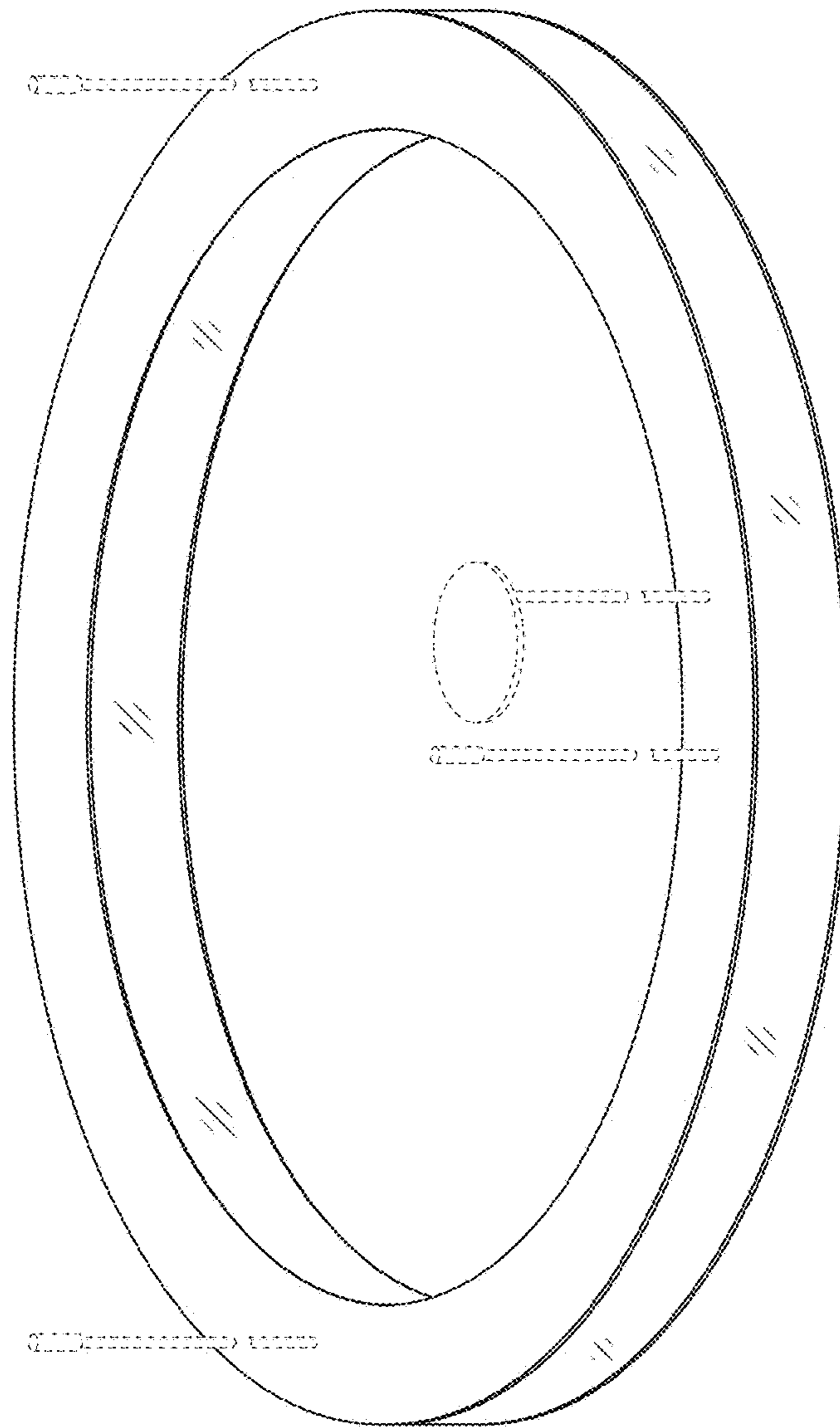

FIG. 45

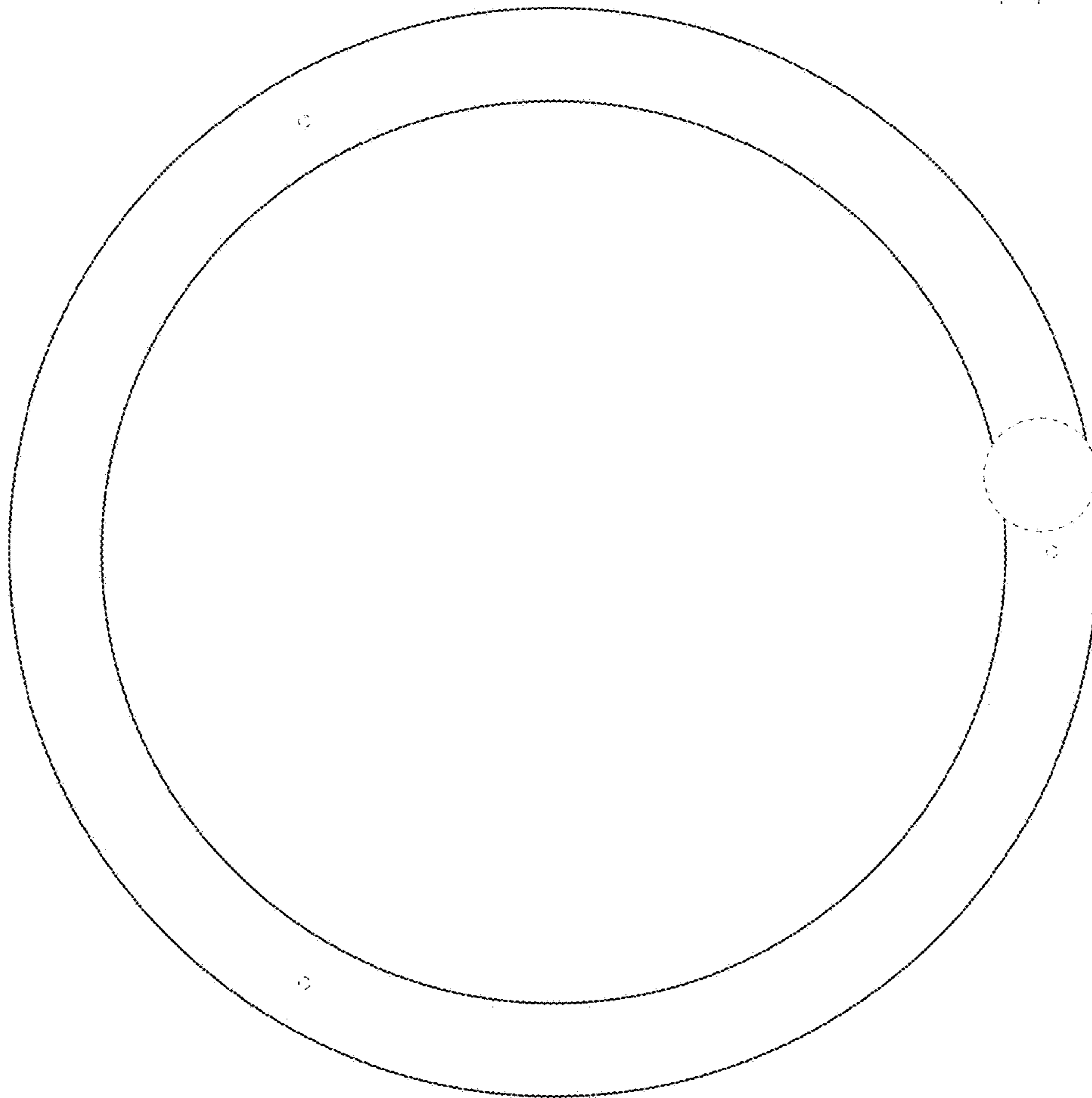

FIG. 46

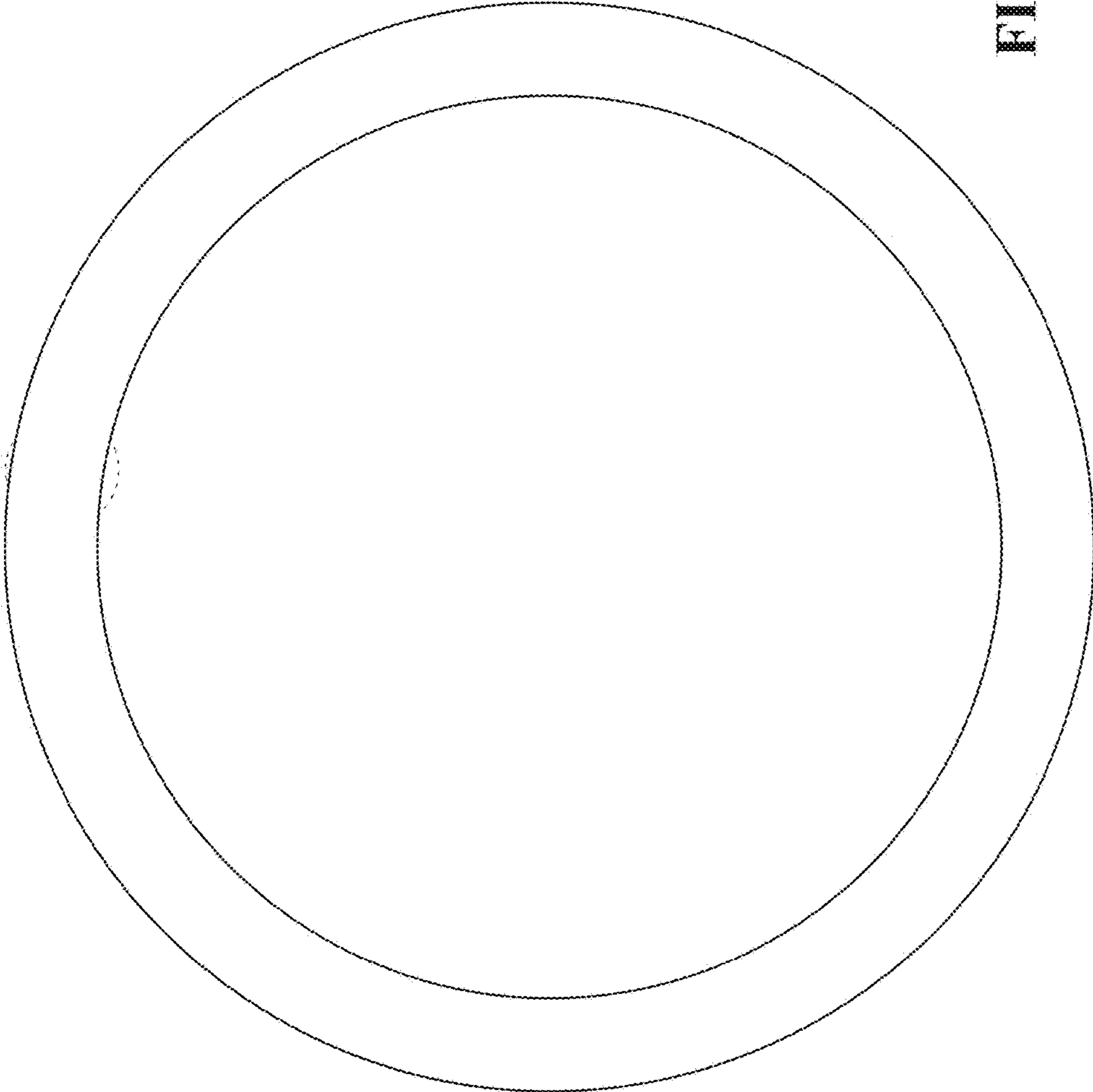

FIG. 47

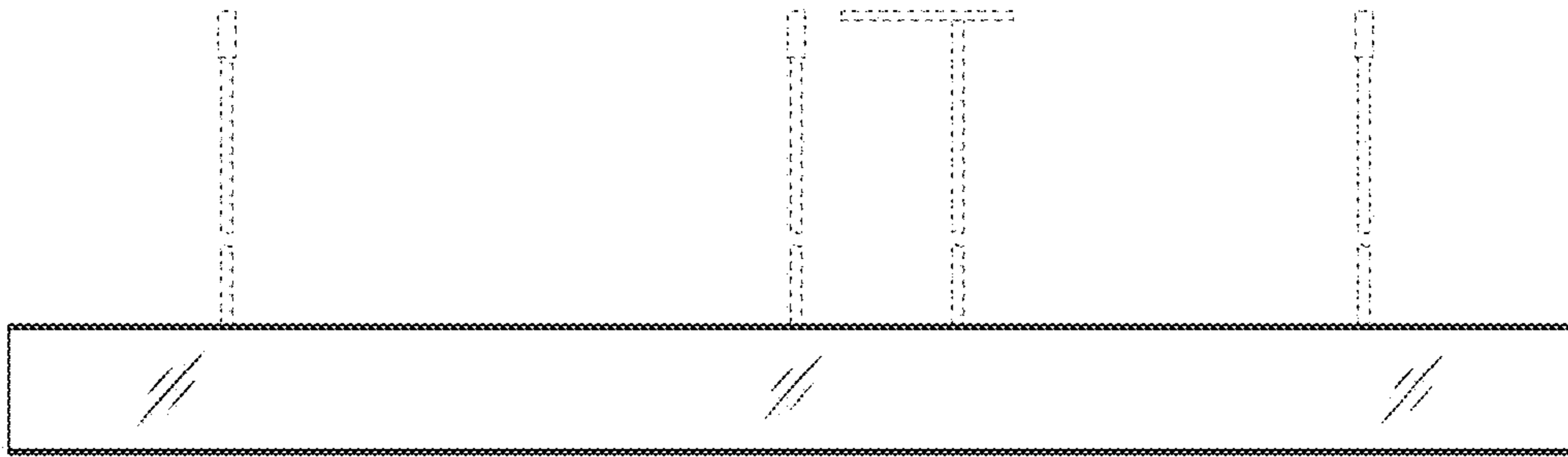

FIG. 48

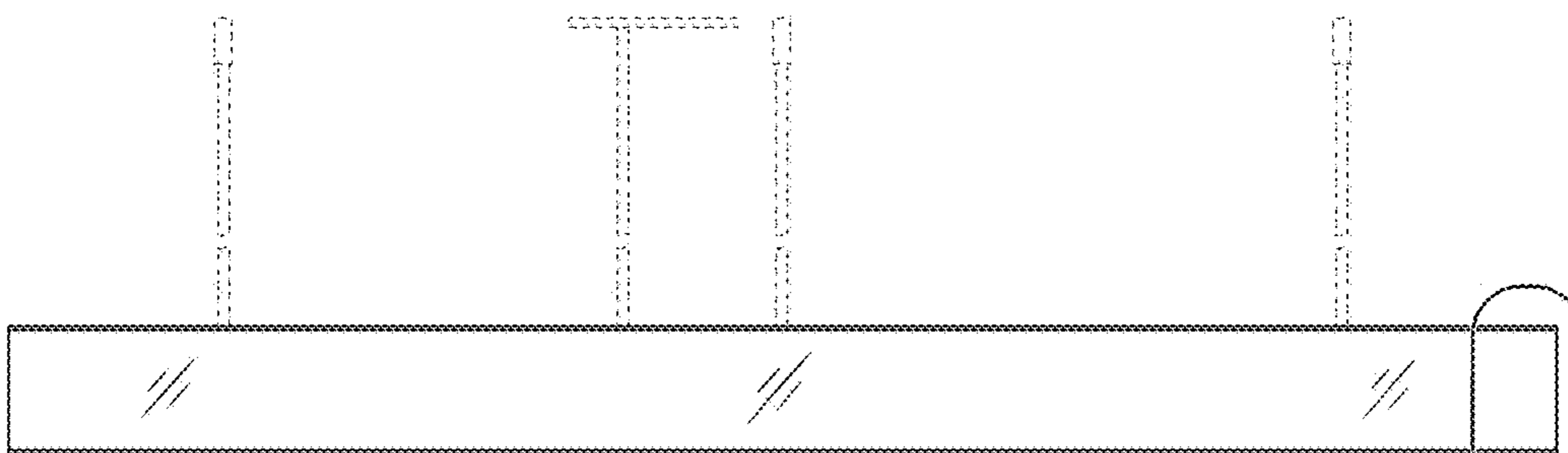

FIG. 49

FIG. 50

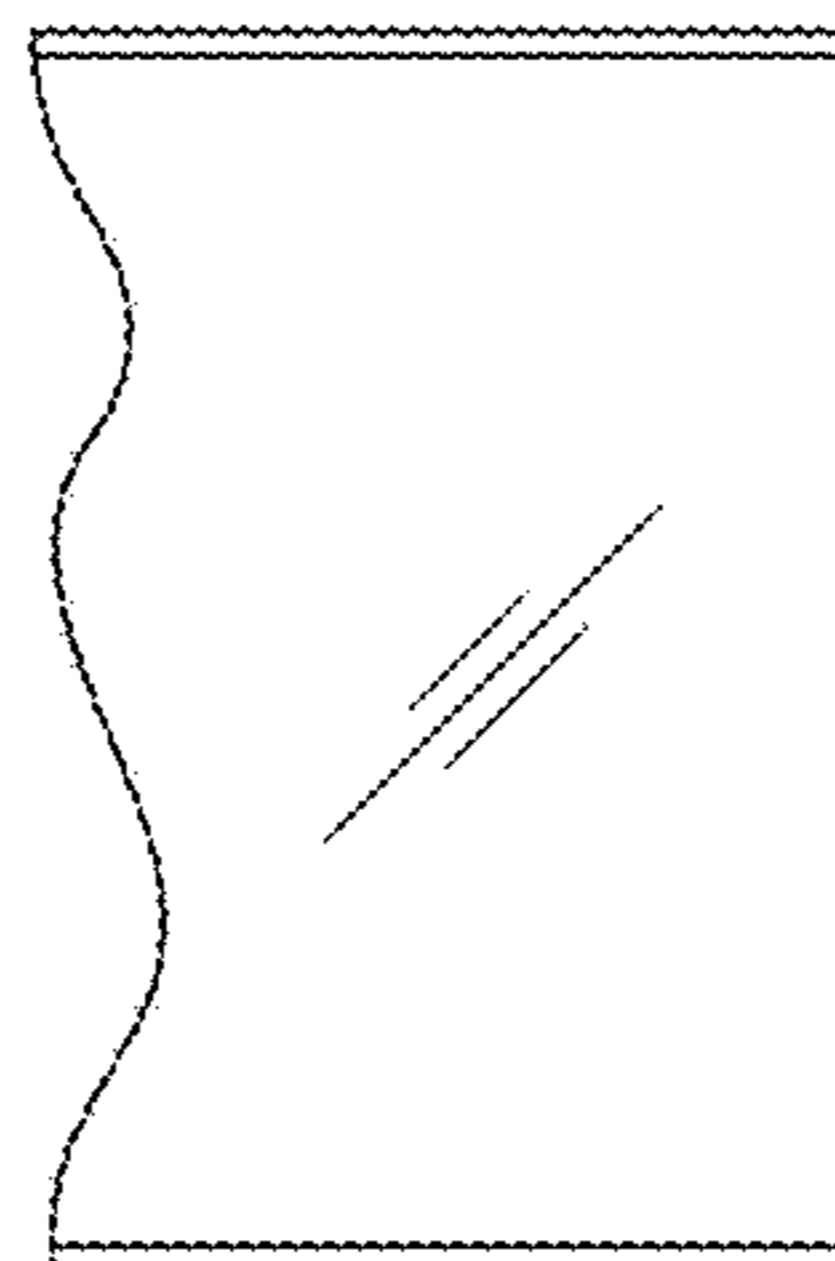

FIG. 50

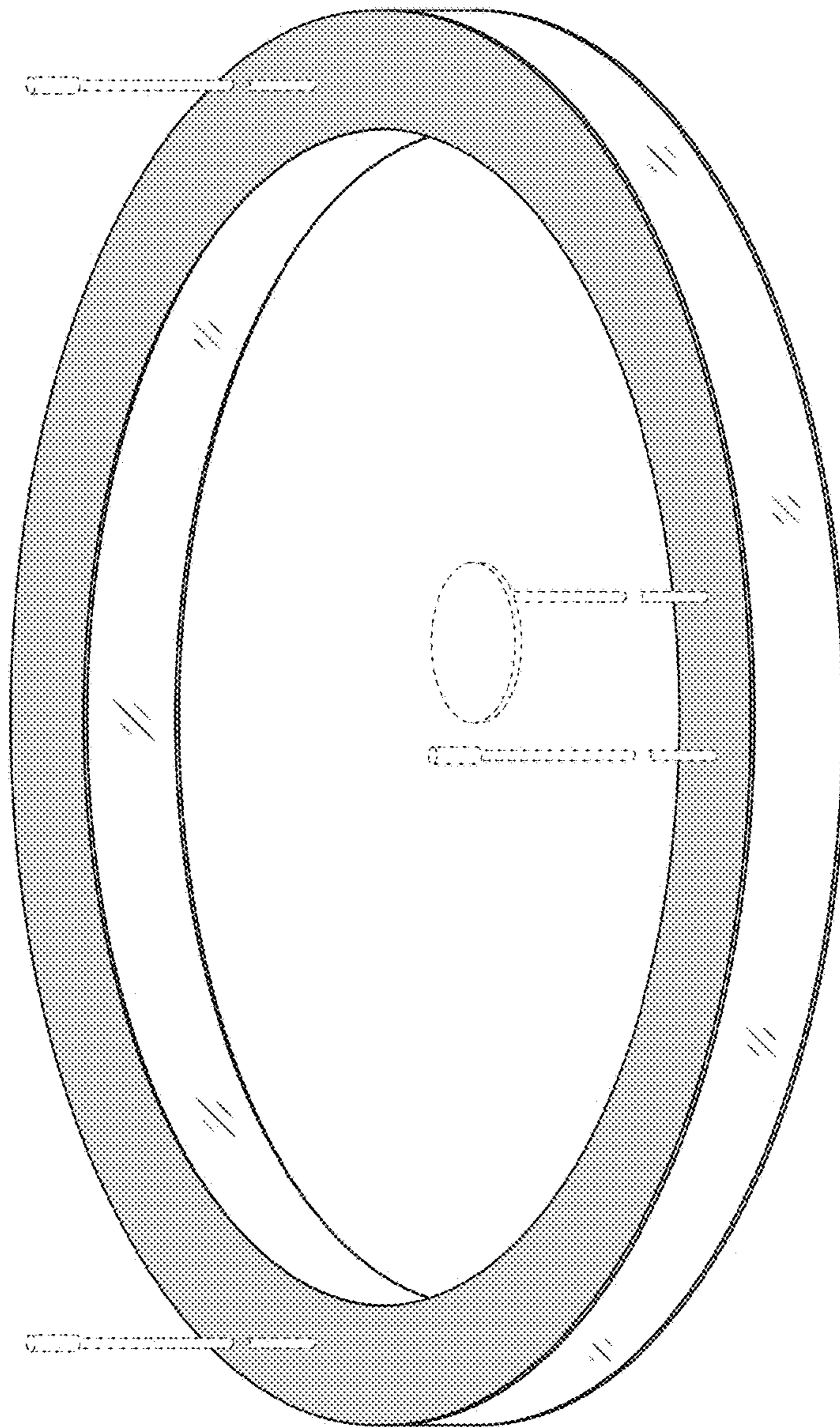

FIG. 51

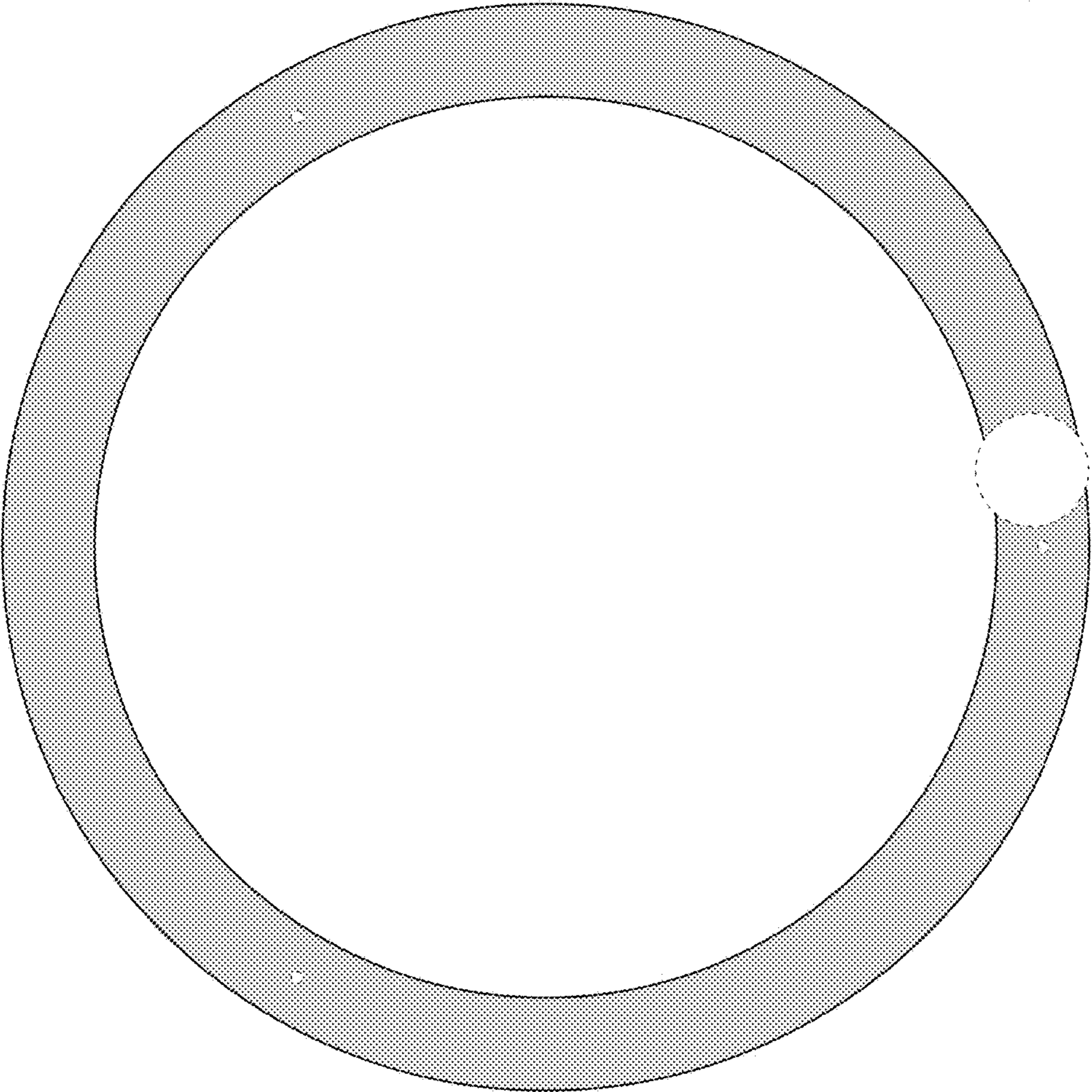

FIG. 52

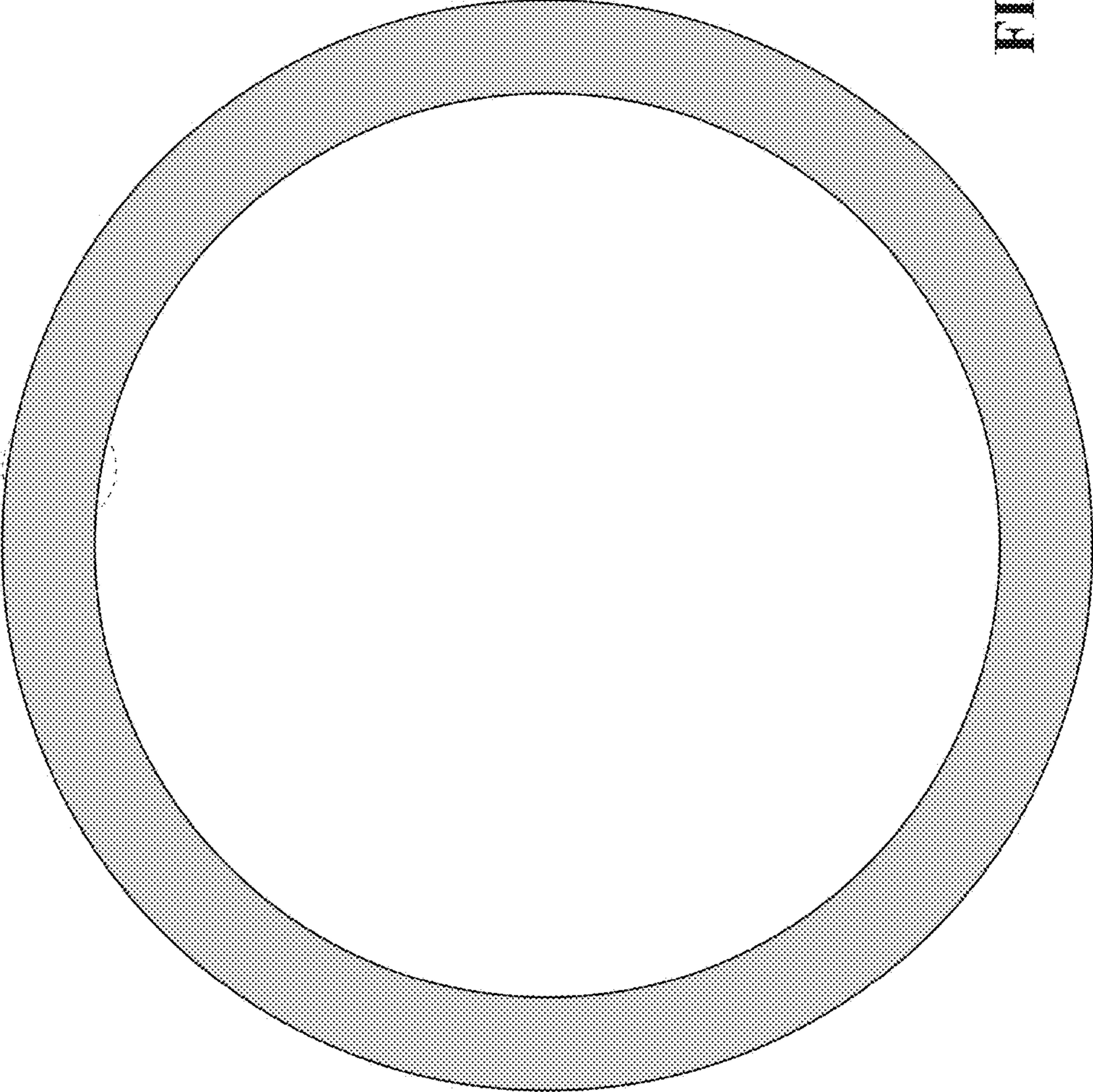

FIG. 53

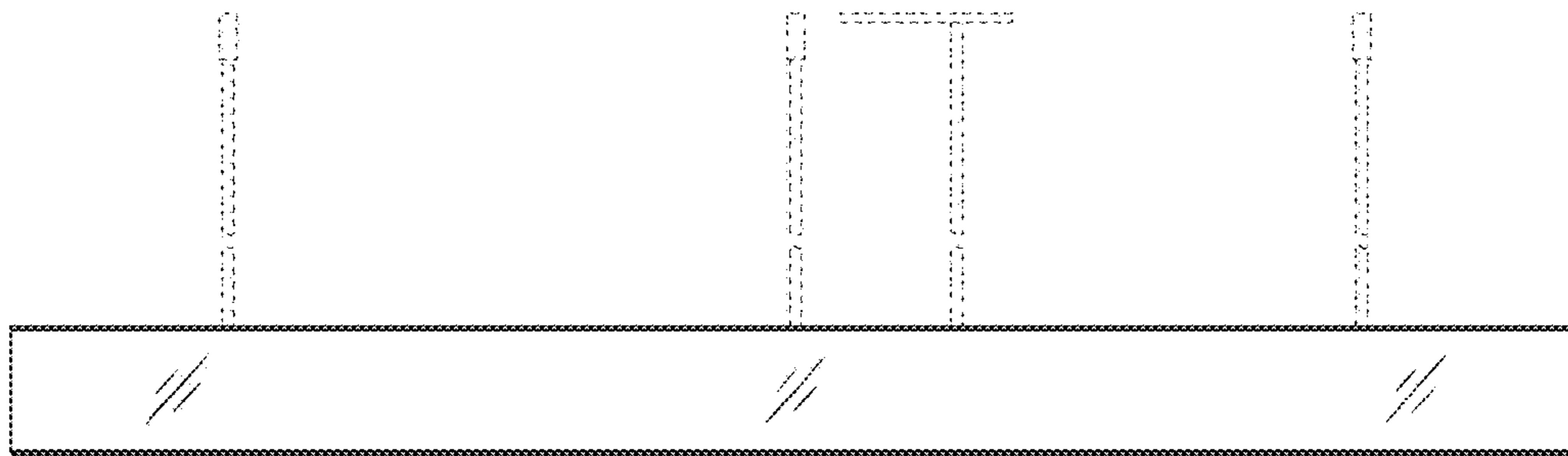

FIG. 54

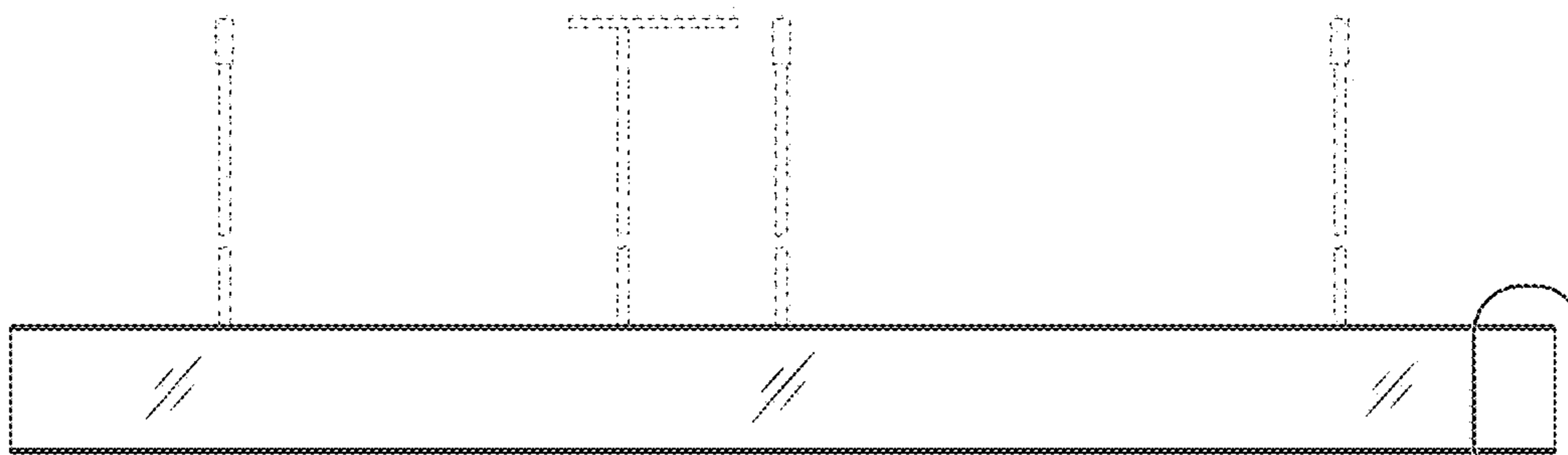

FIG. 55

FIG. 56

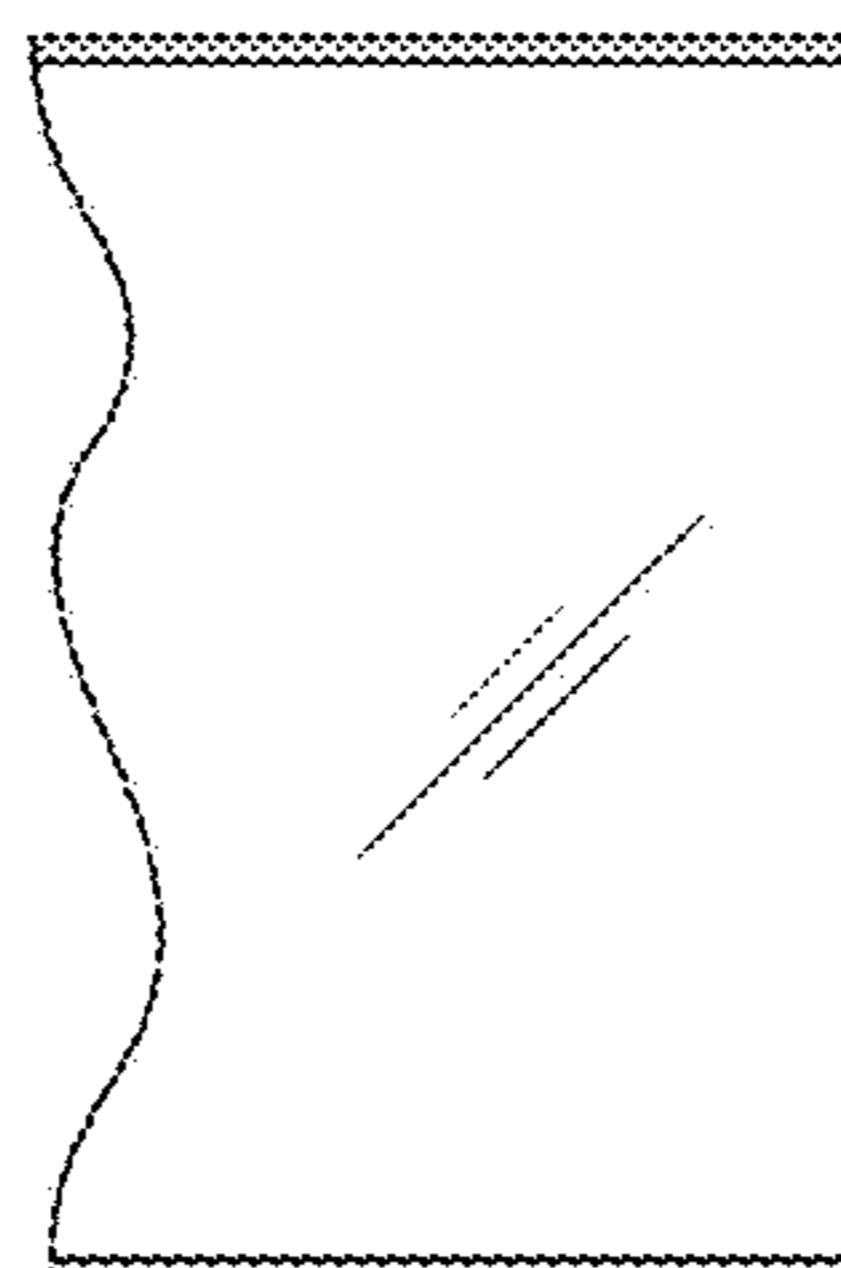

FIG. 56

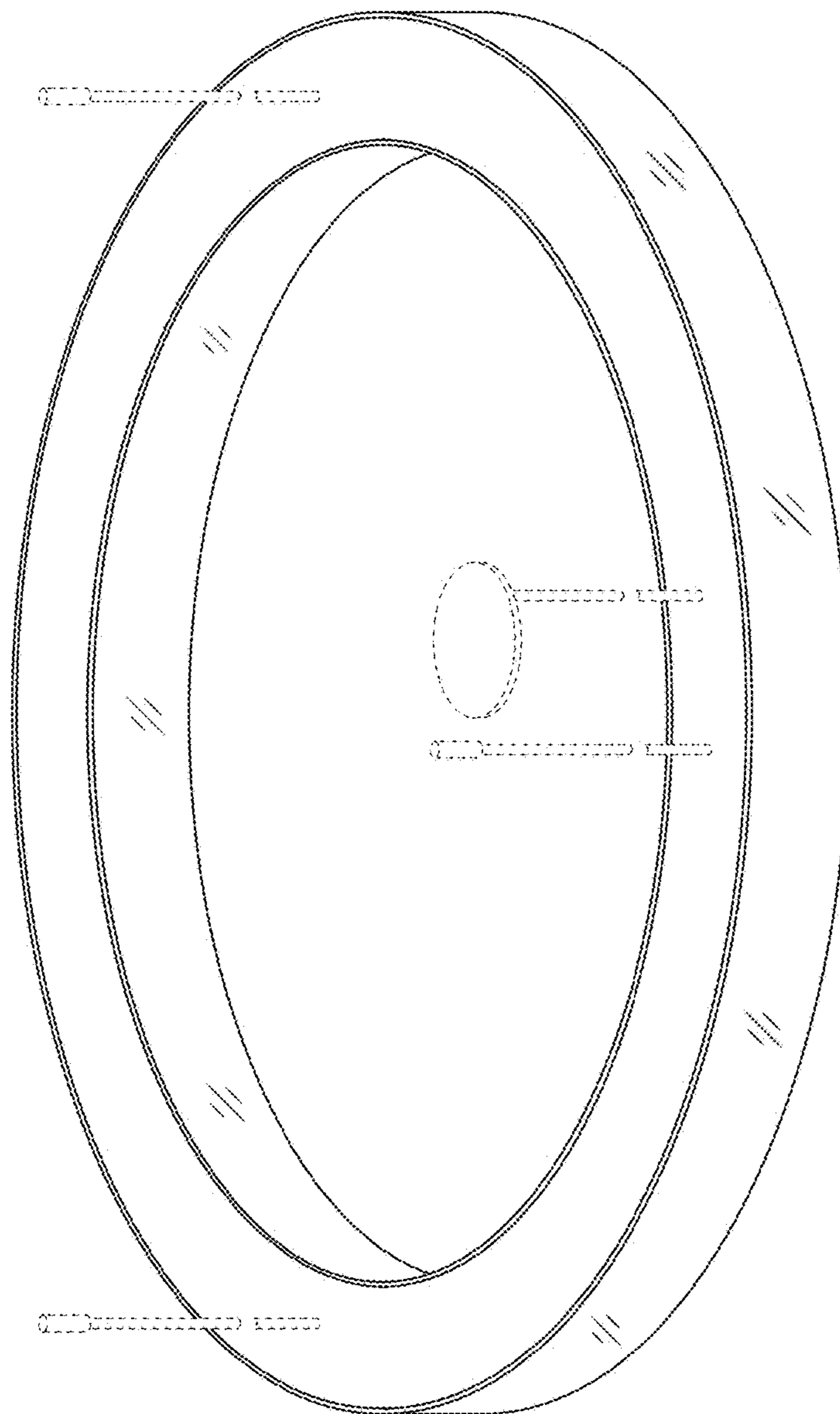
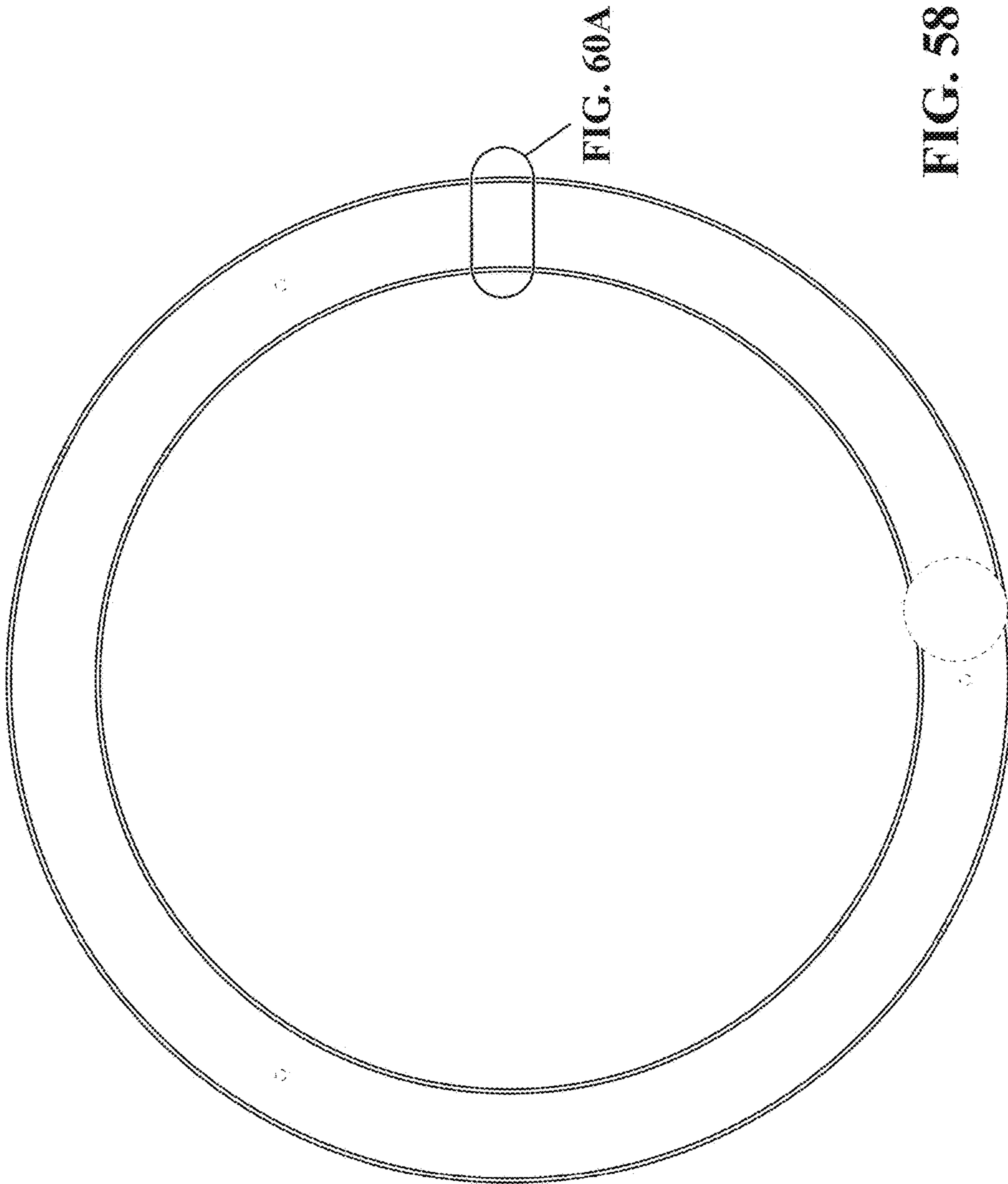
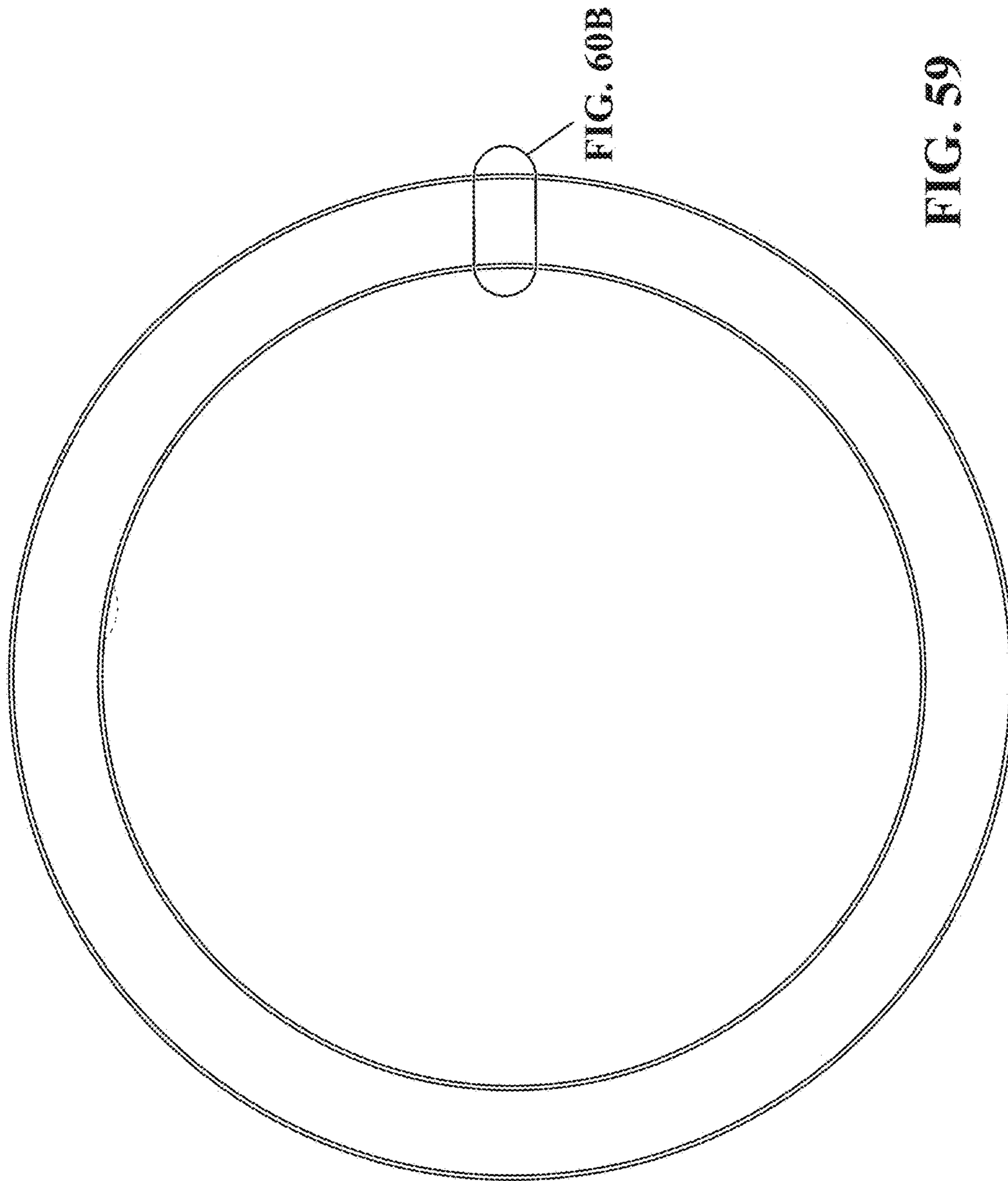

FIG. 57





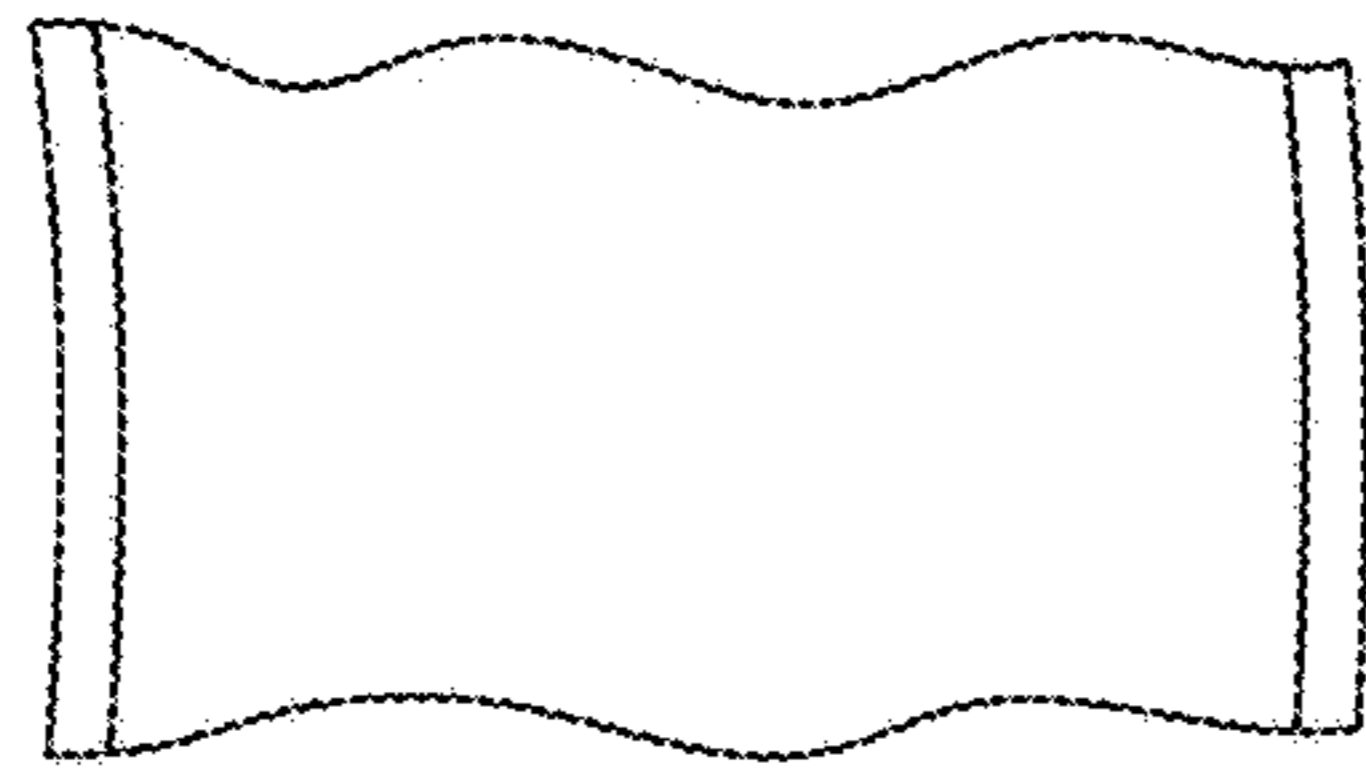

FIG. 60A

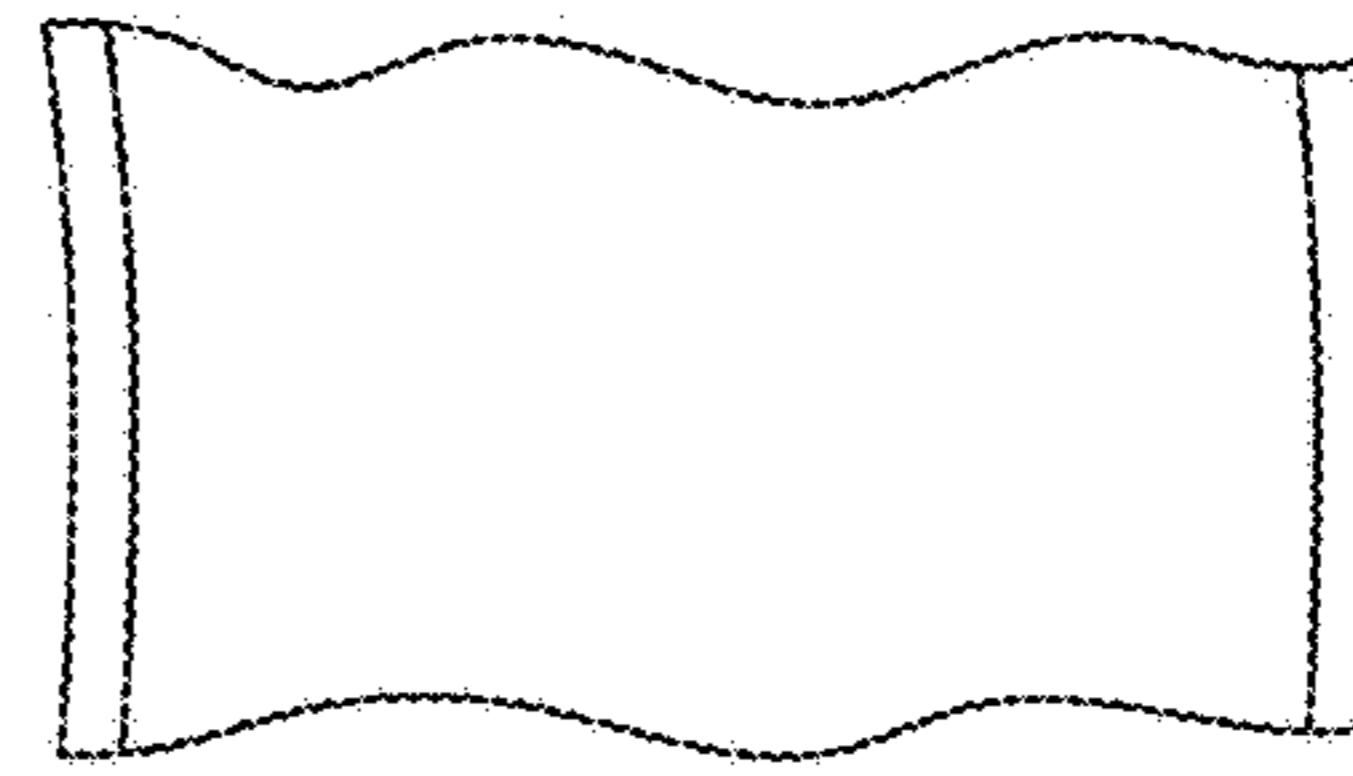

FIG. 60B

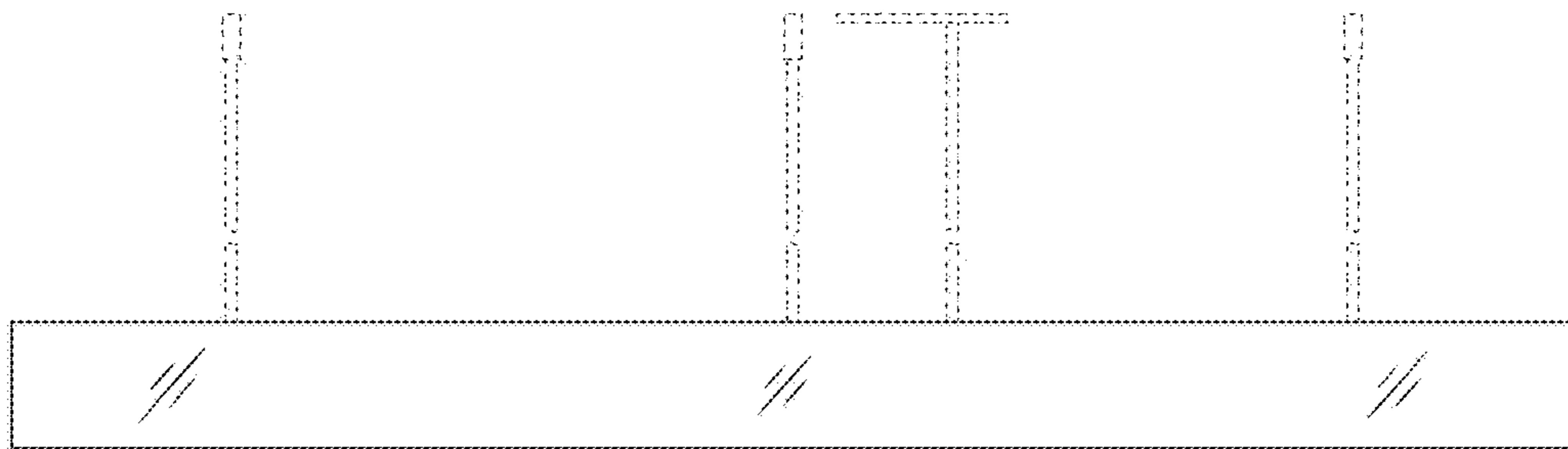

FIG. 61

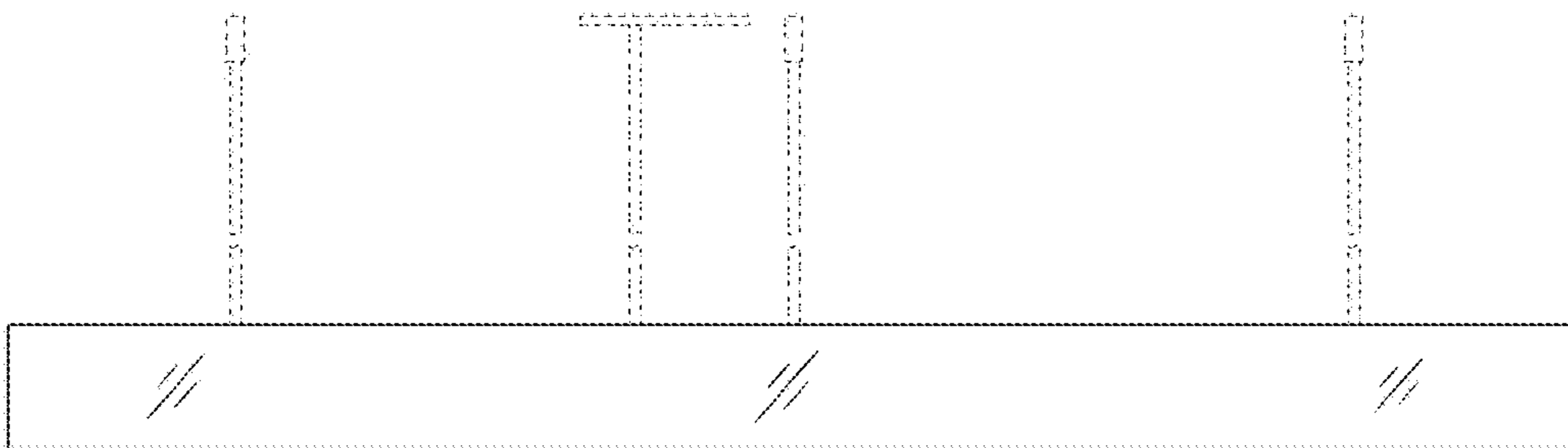

FIG. 62

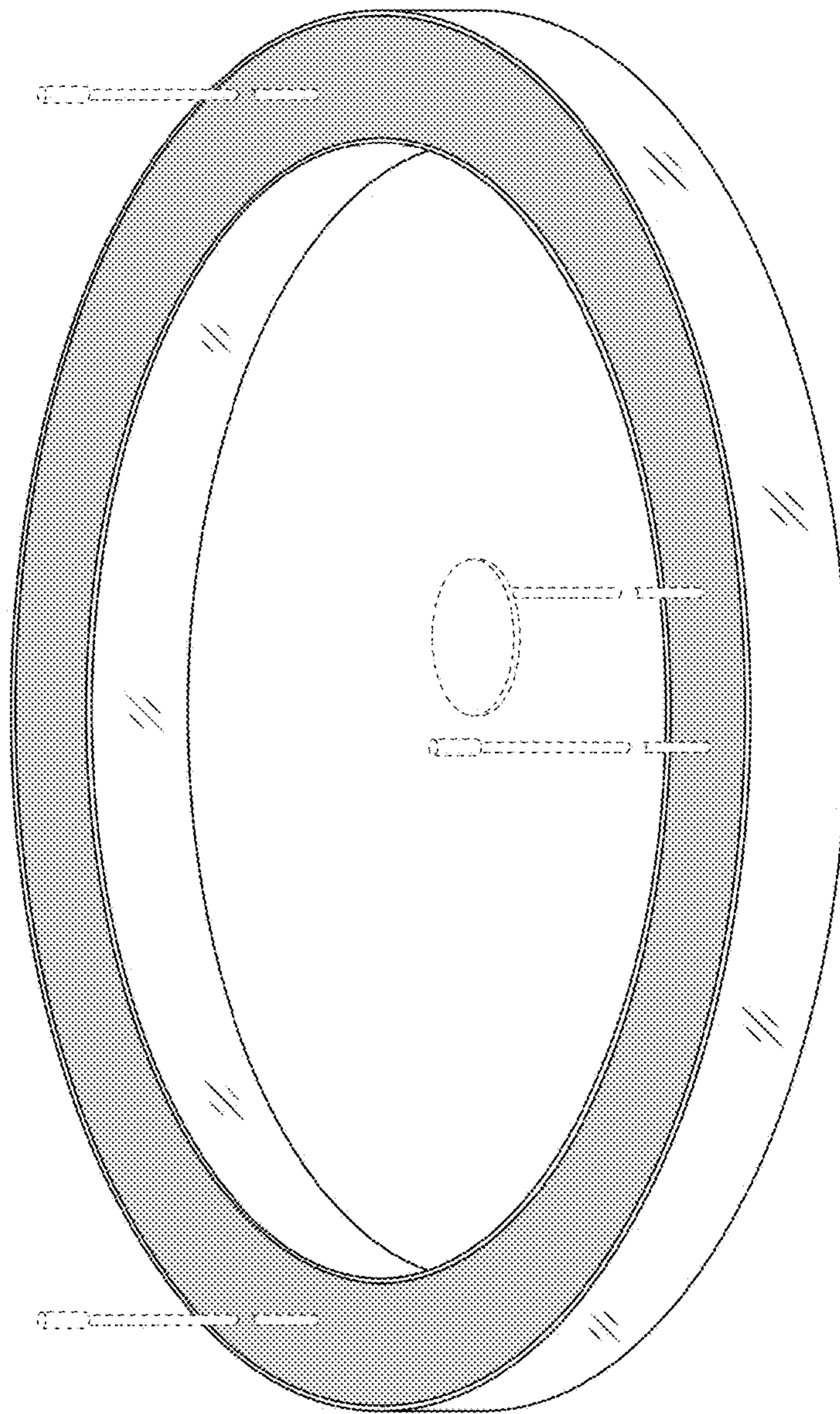
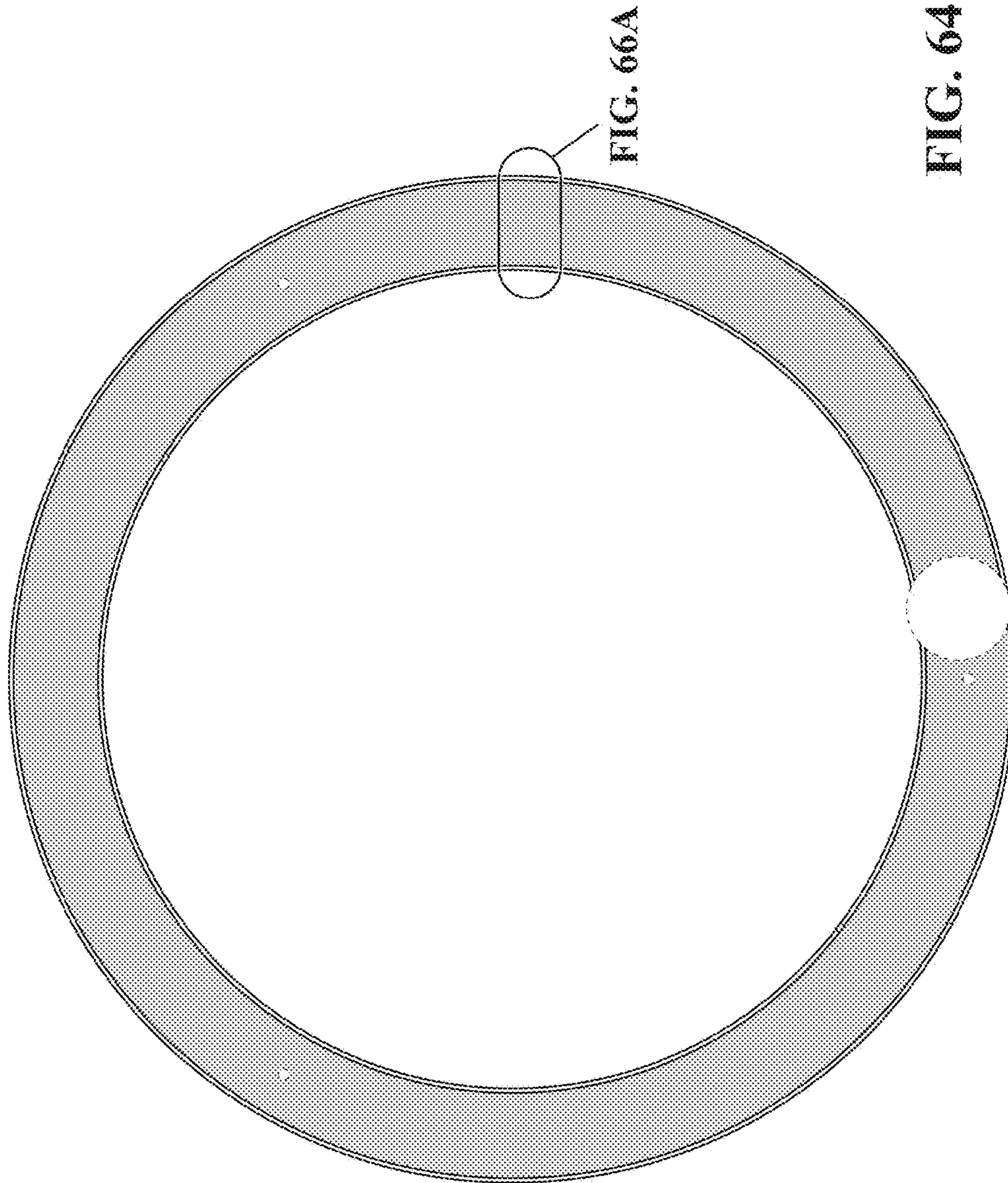
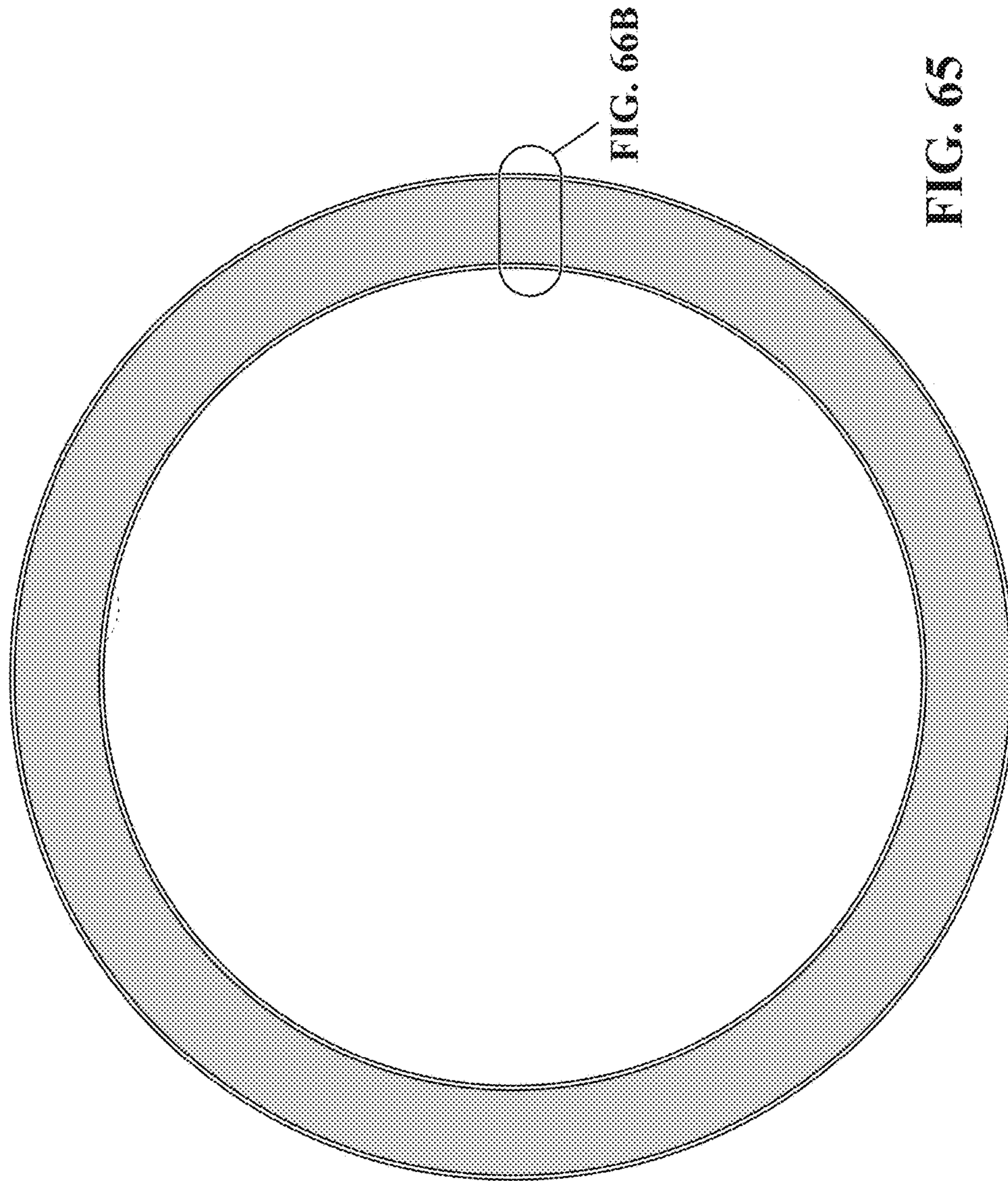

FIG. 63





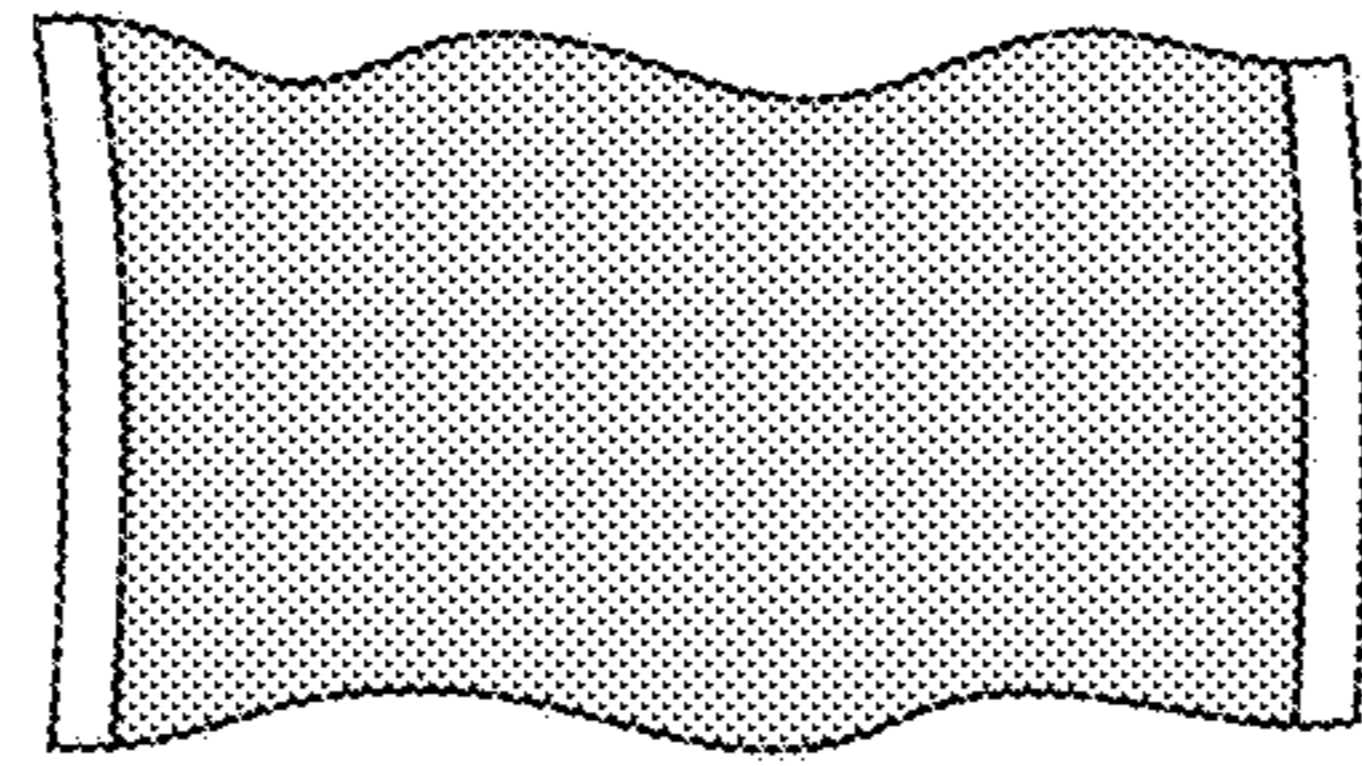

FIG. 66A

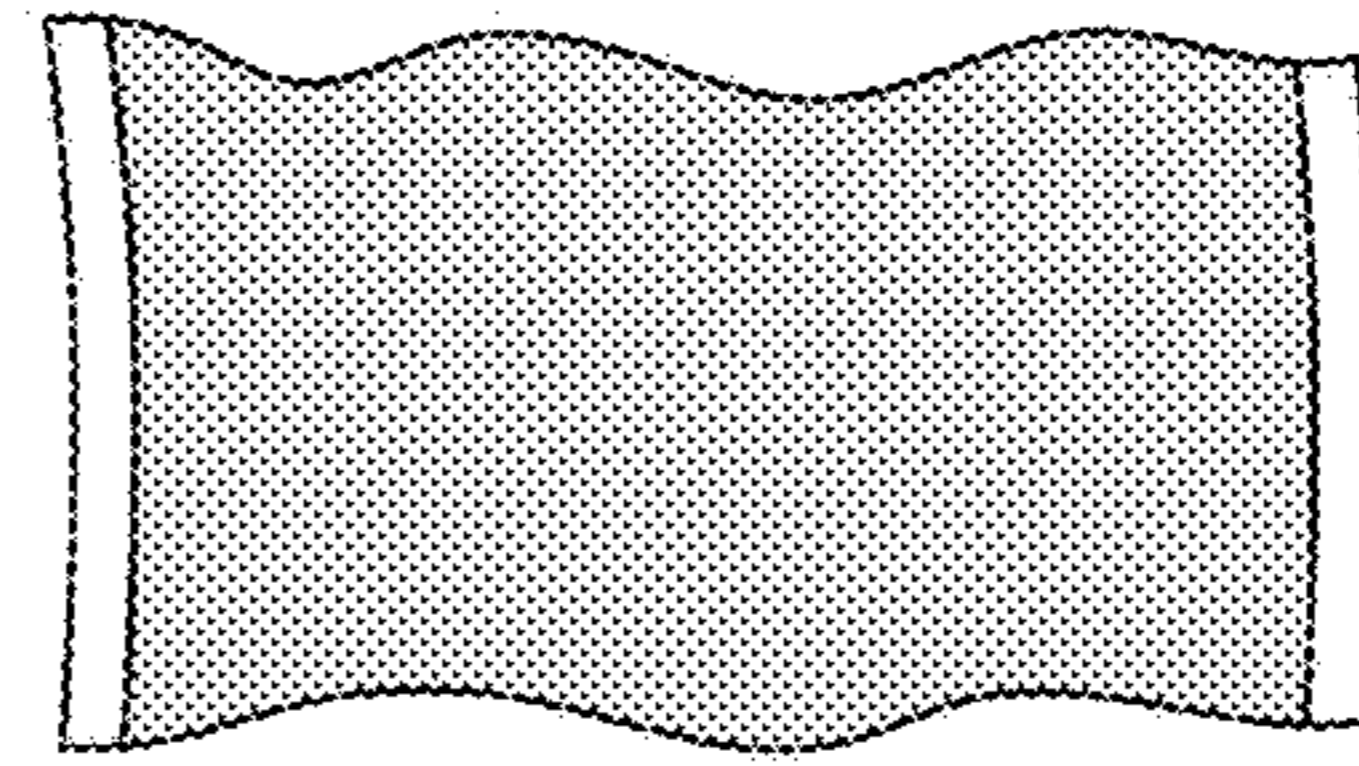

FIG. 66B

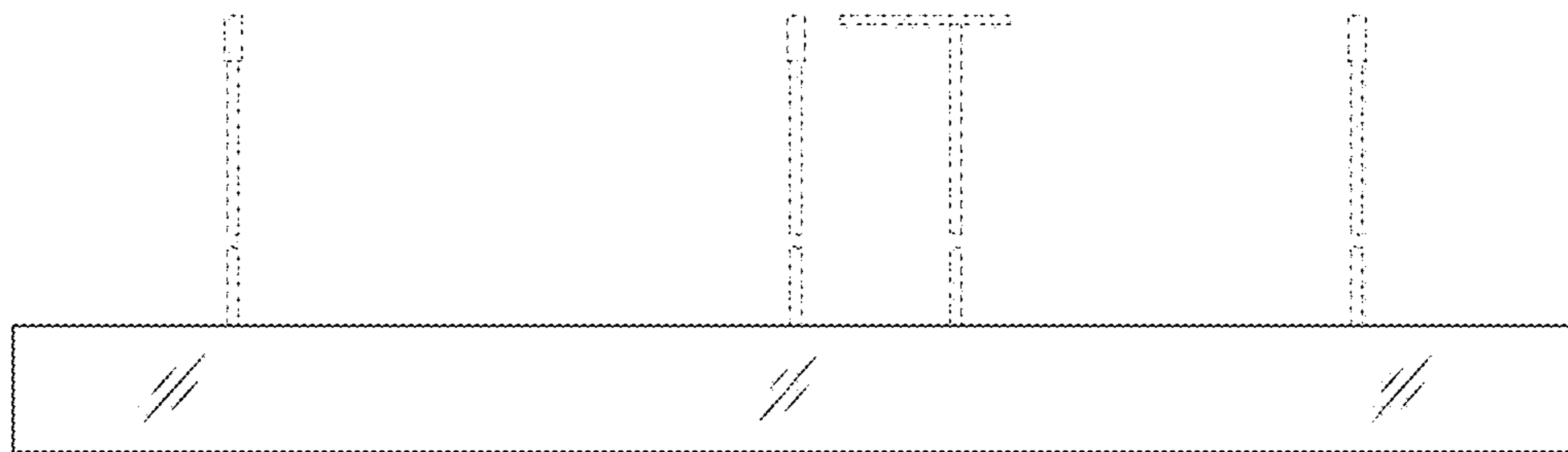

FIG. 67

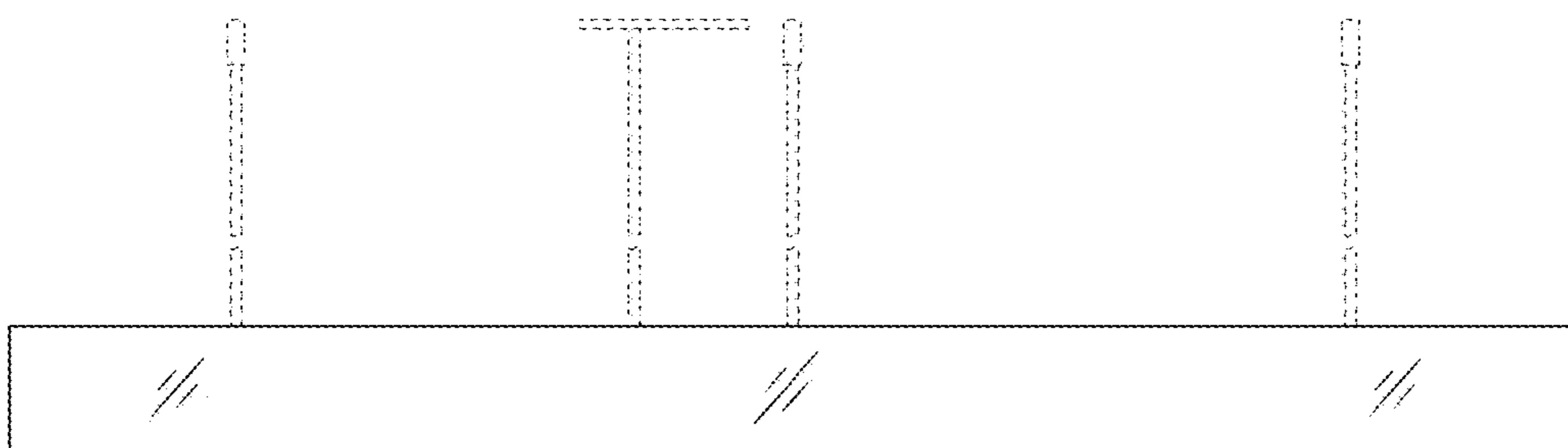

FIG. 68

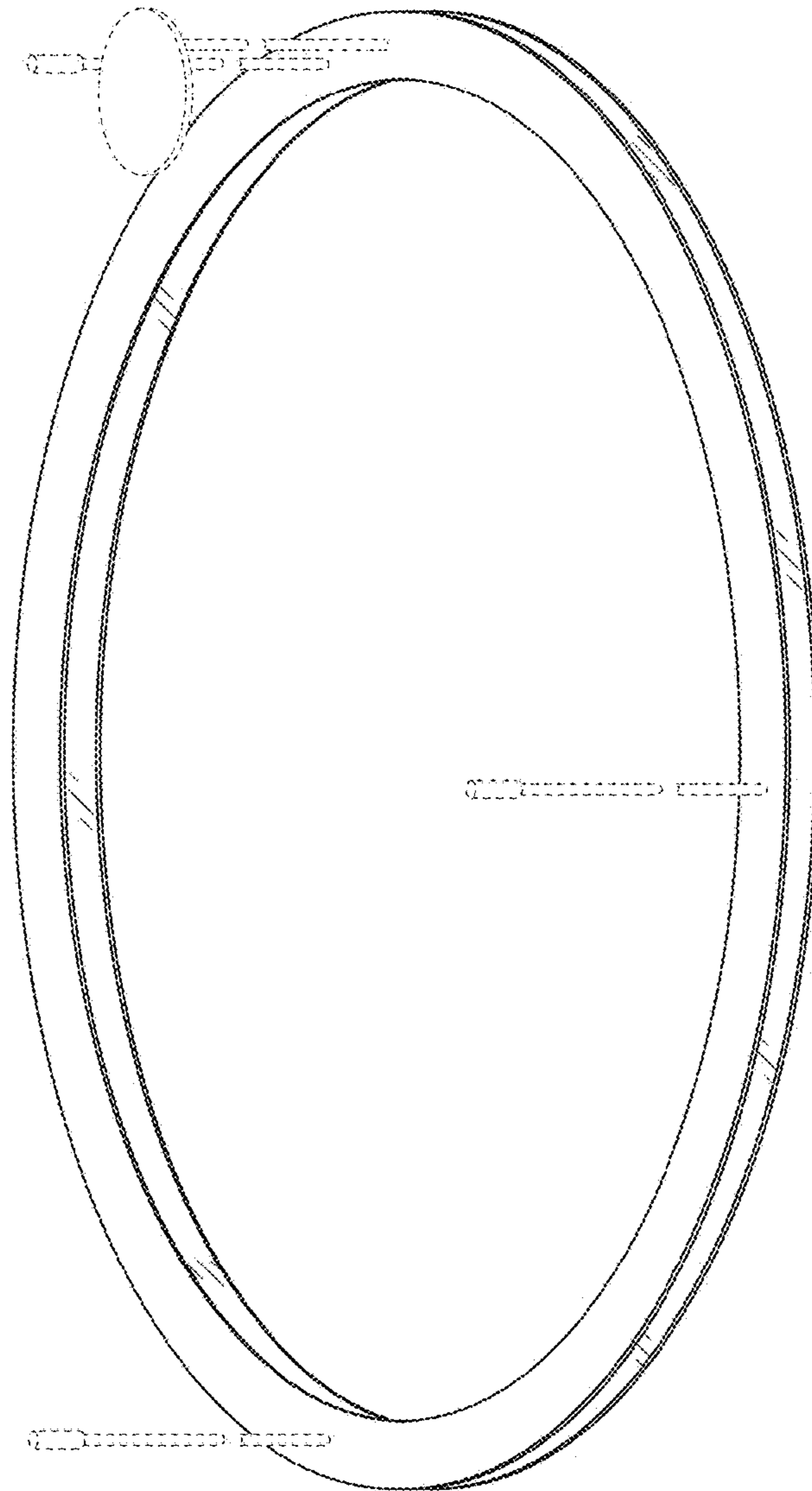

FIG. 69

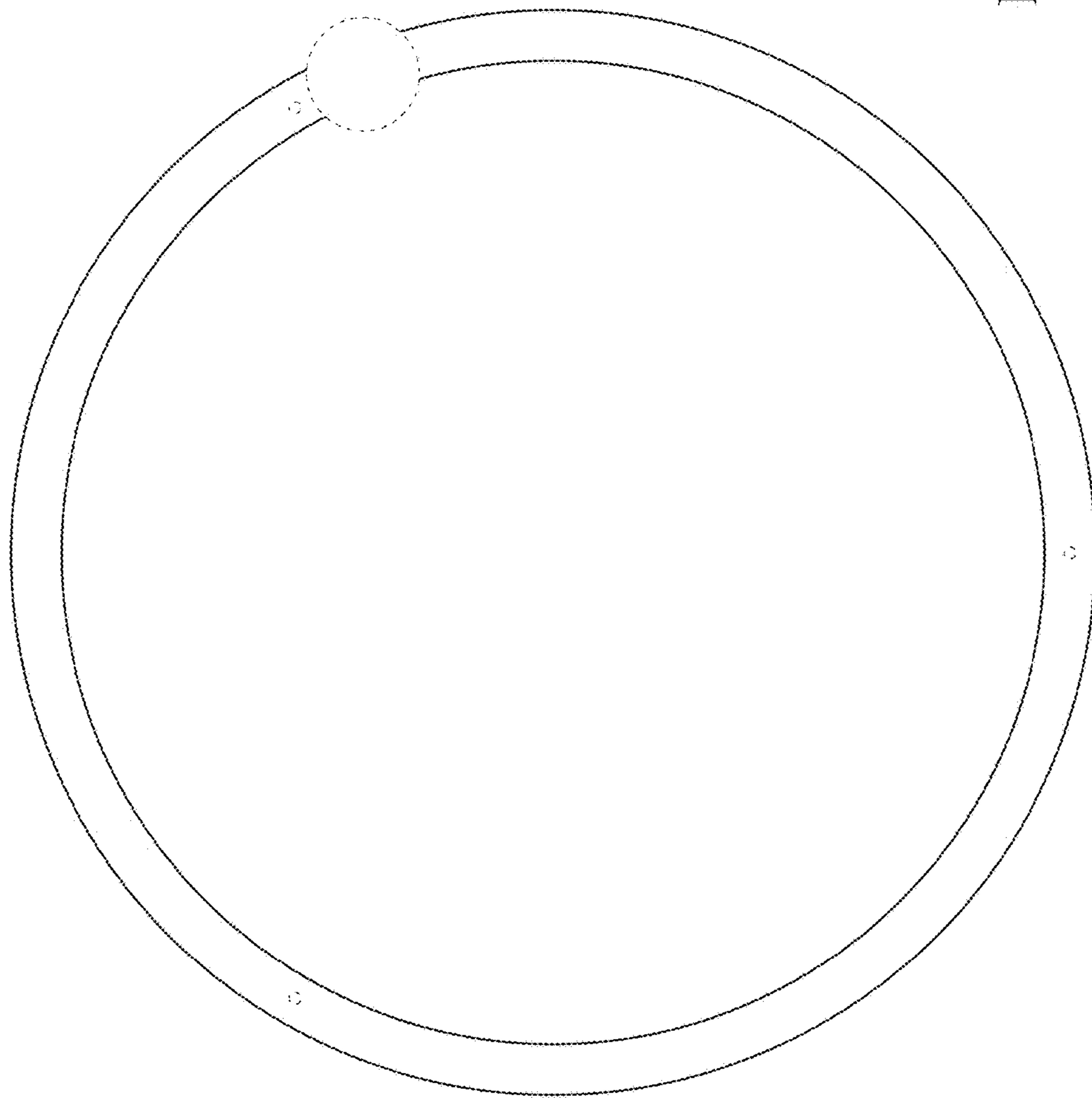

FIG. 70

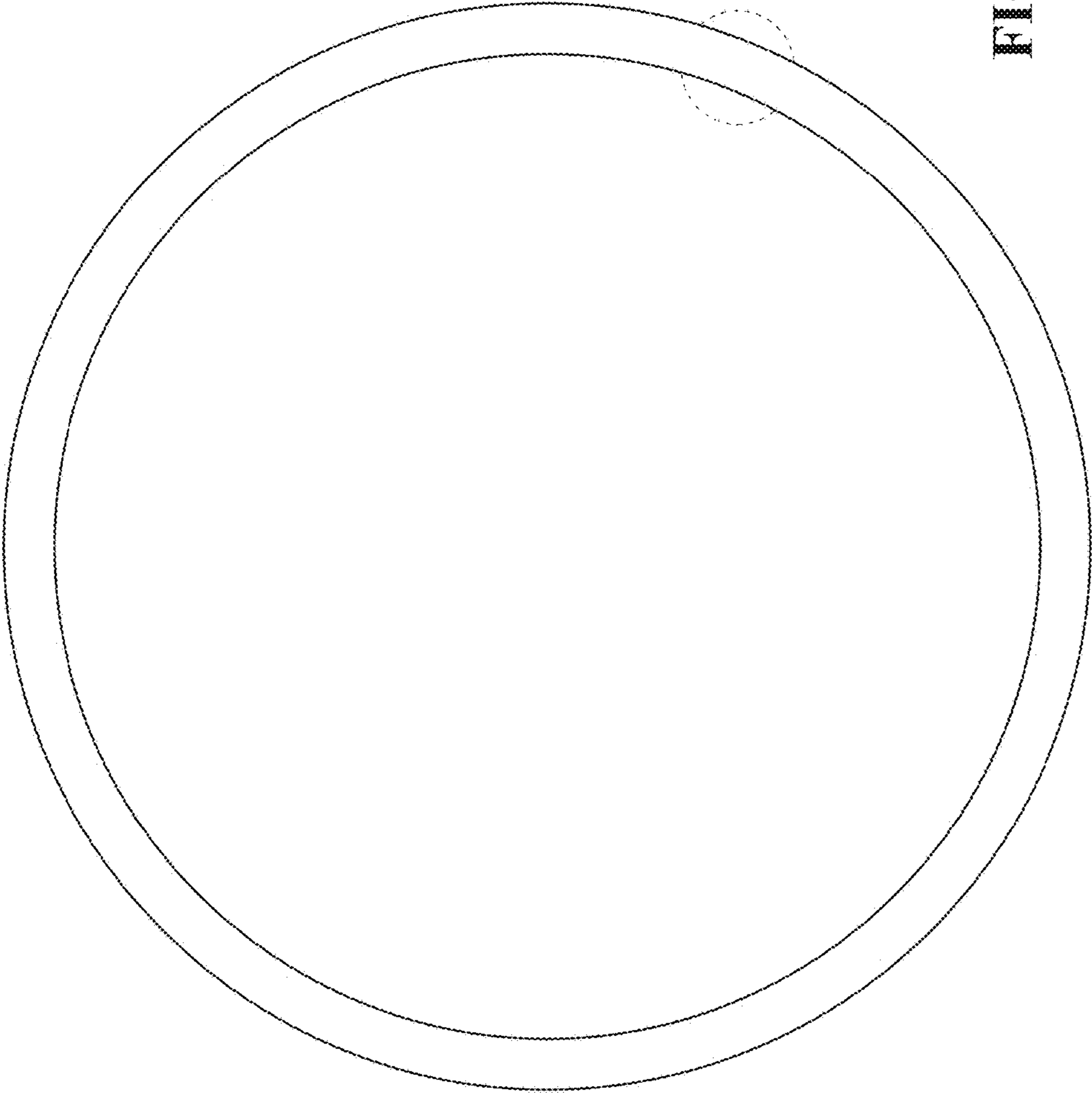

FIG. 71

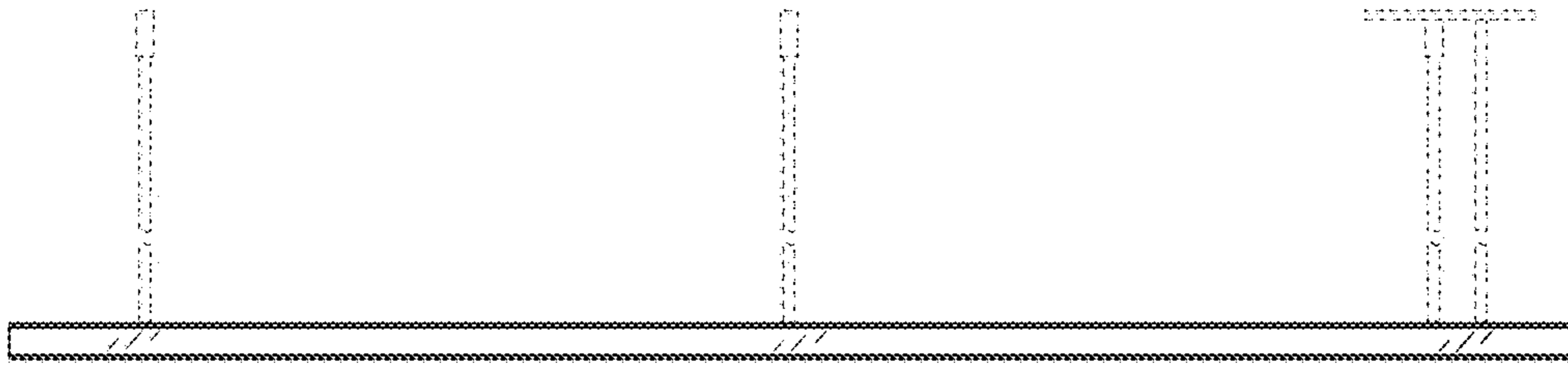

FIG. 72

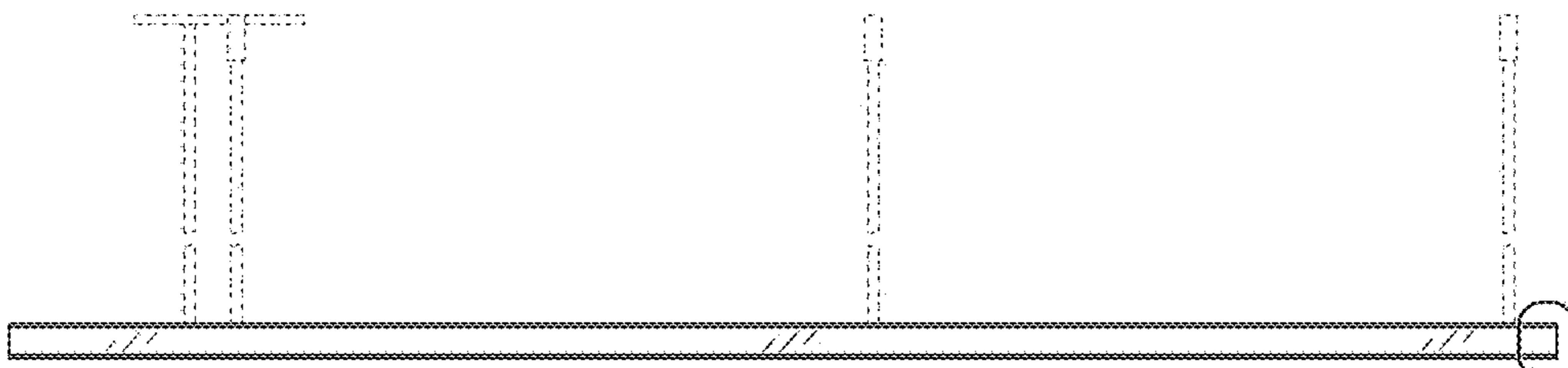

FIG. 73



FIG. 74

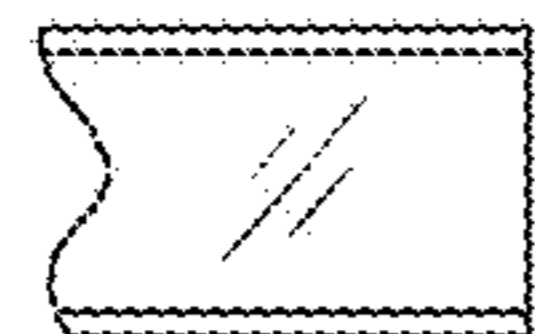

FIG. 74

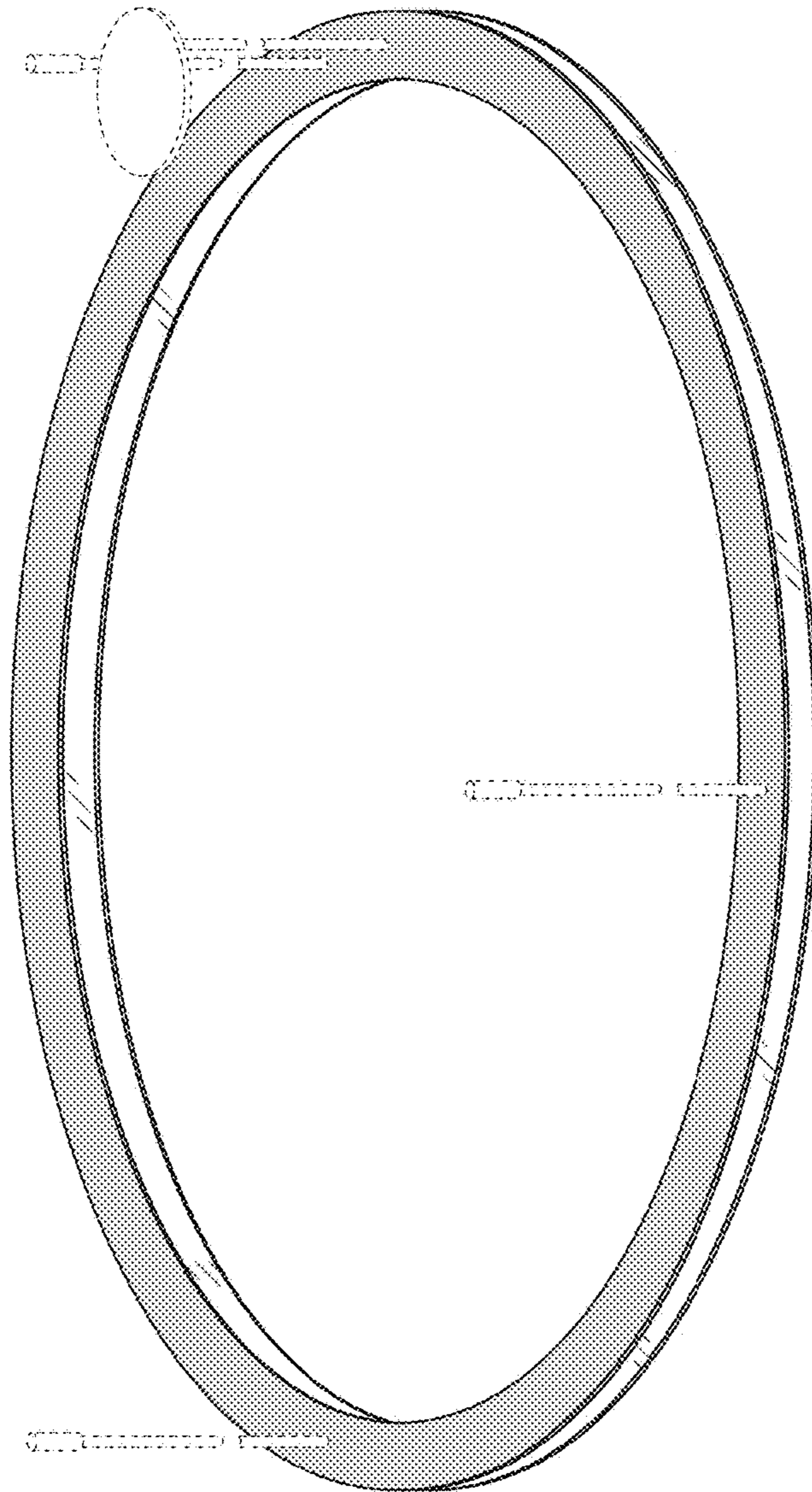

FIG. 75

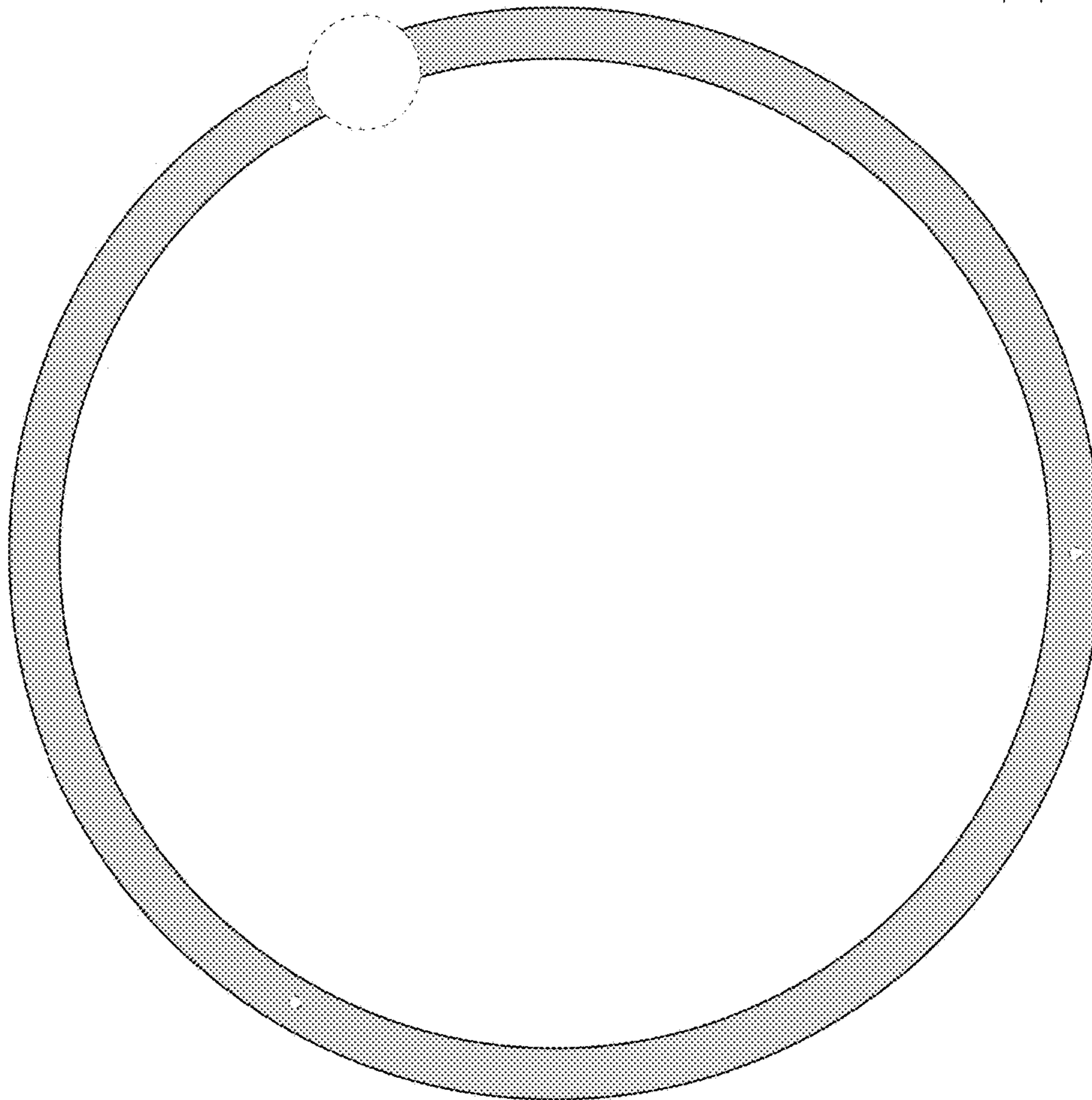

FIG. 76

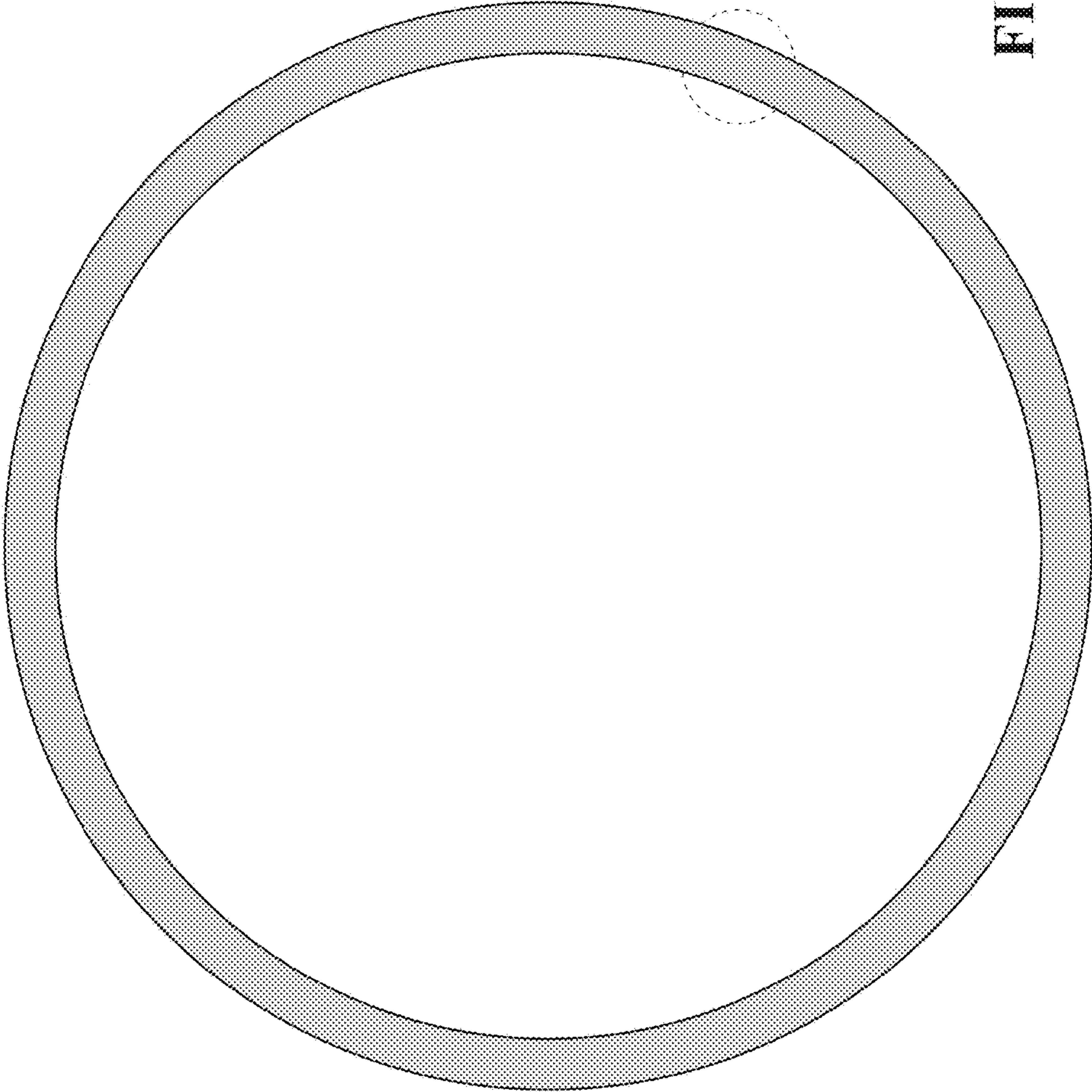

FIG. 77

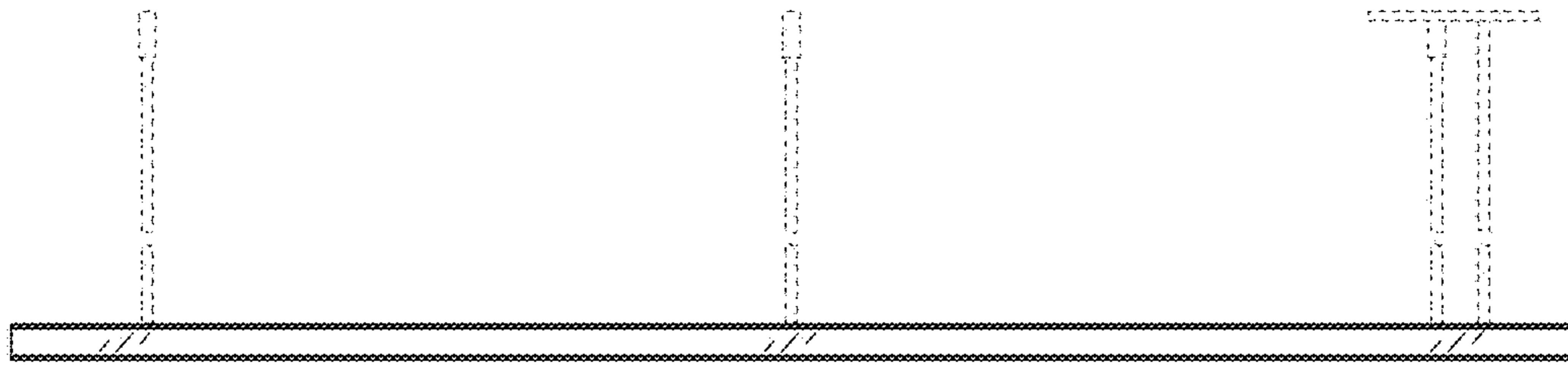

FIG. 78

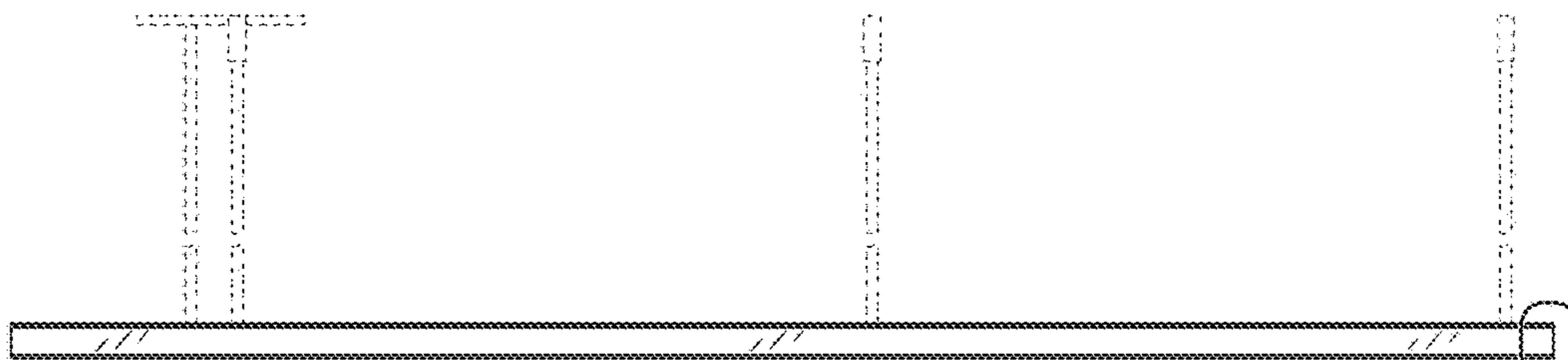

FIG. 79

FIG. 80



FIG. 80

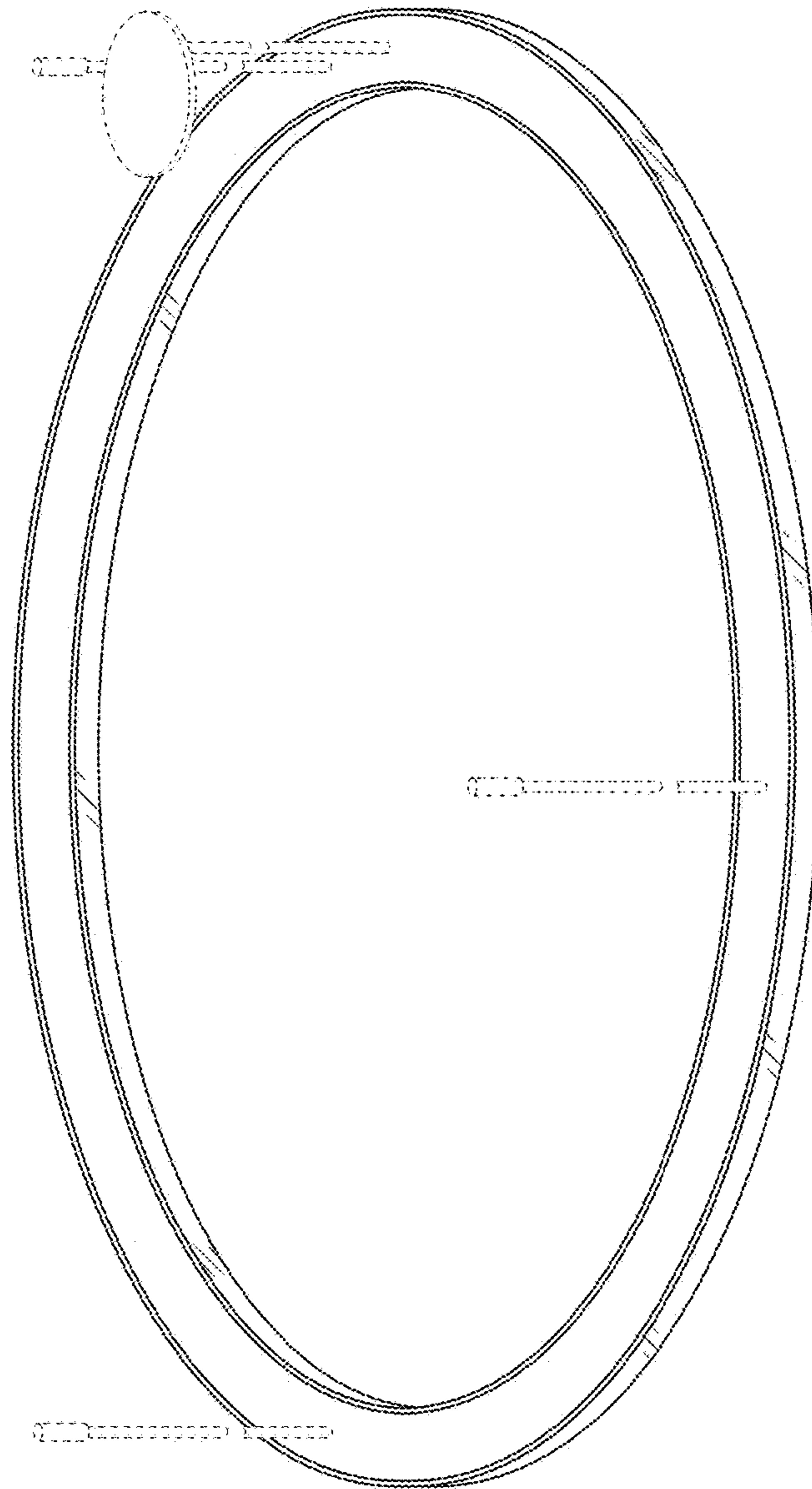
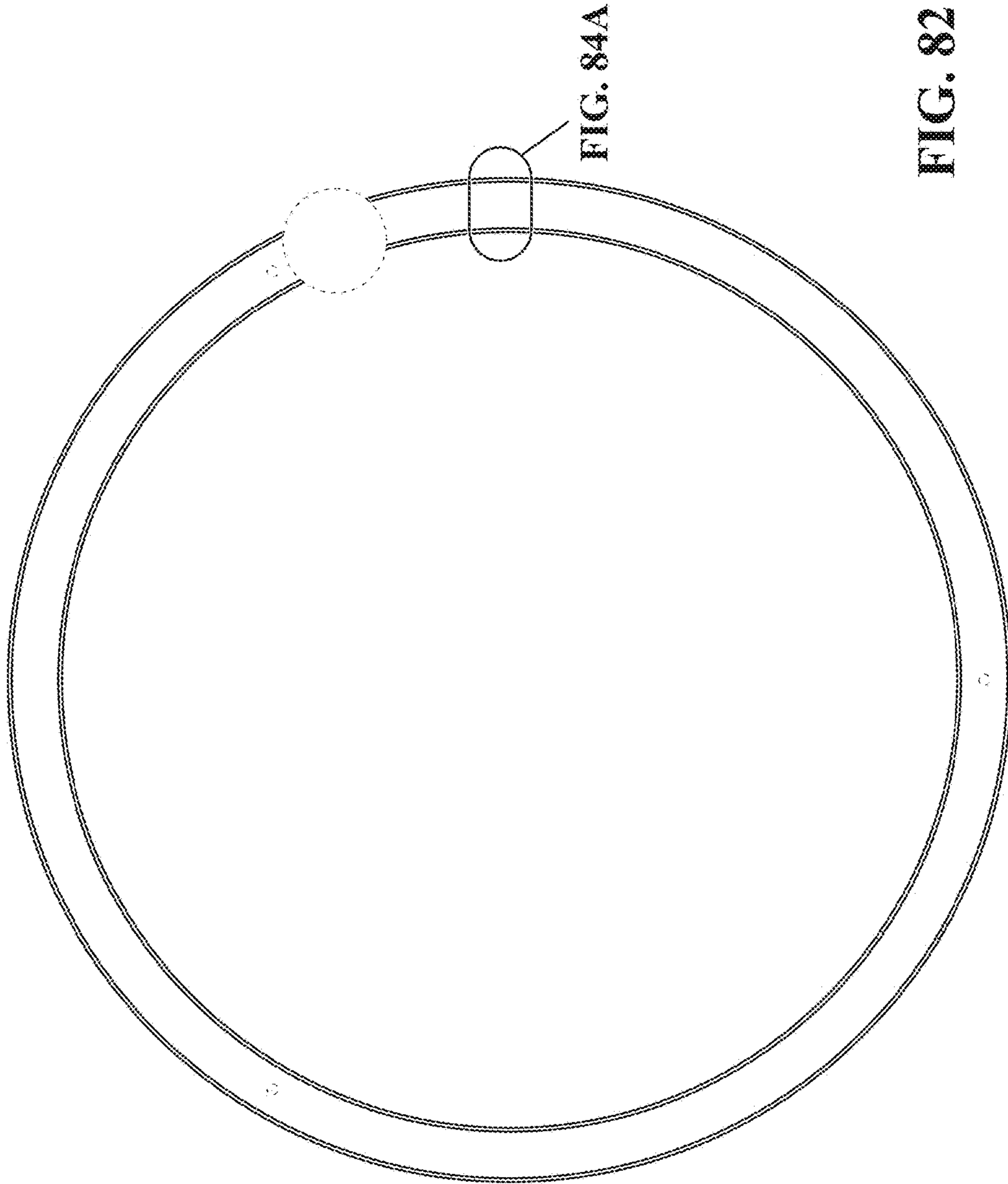

FIG. 81



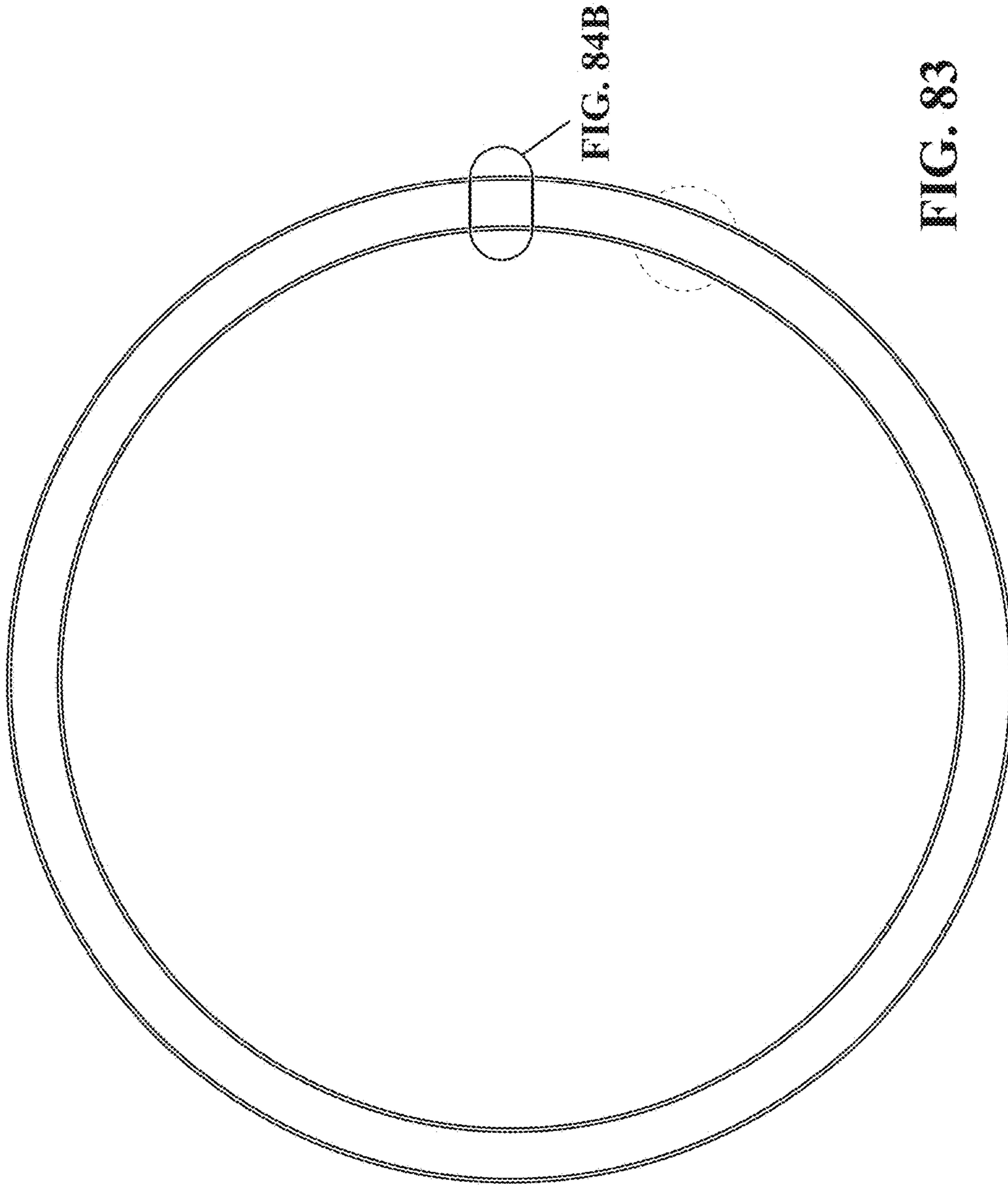

FIG. 84B

FIG. 83

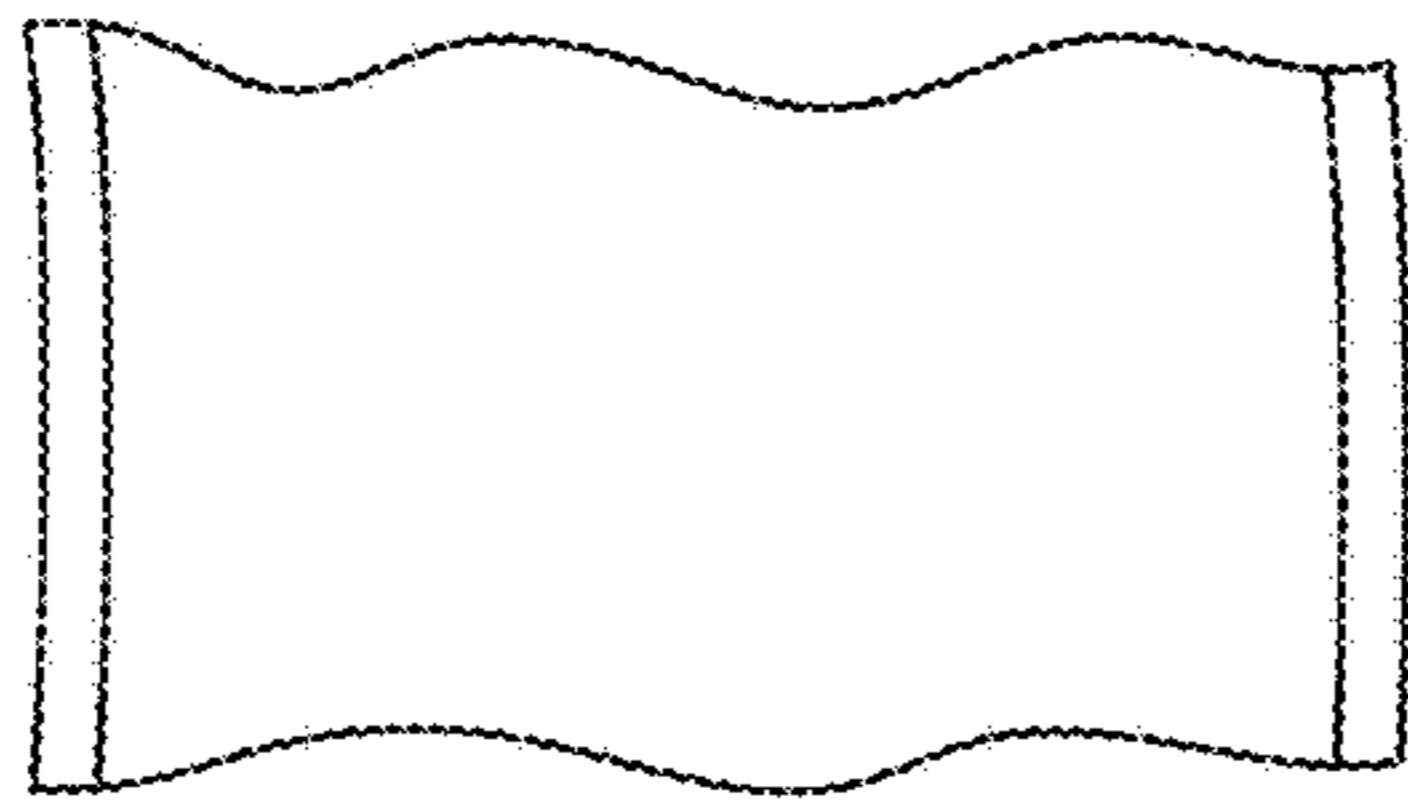

FIG. 84A

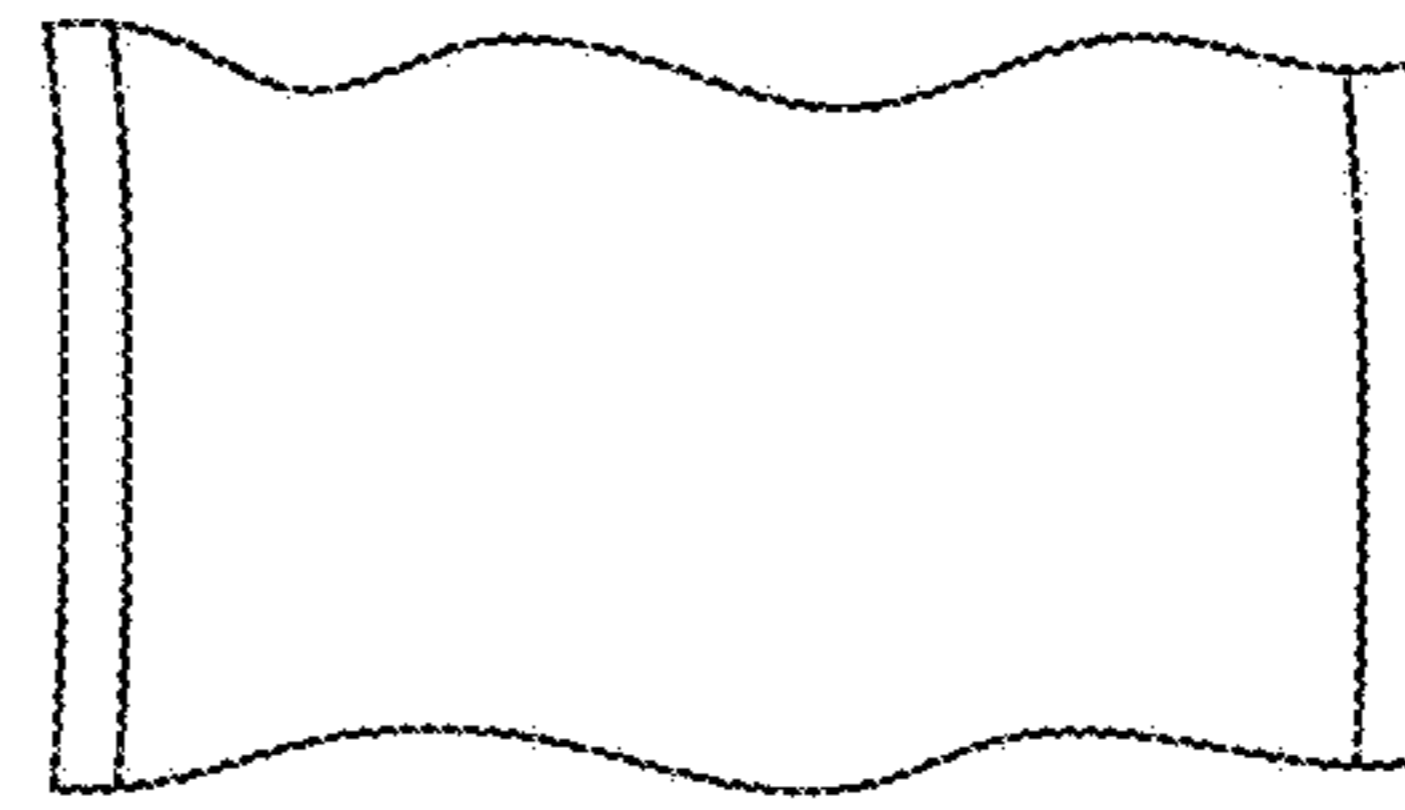

FIG. 84B

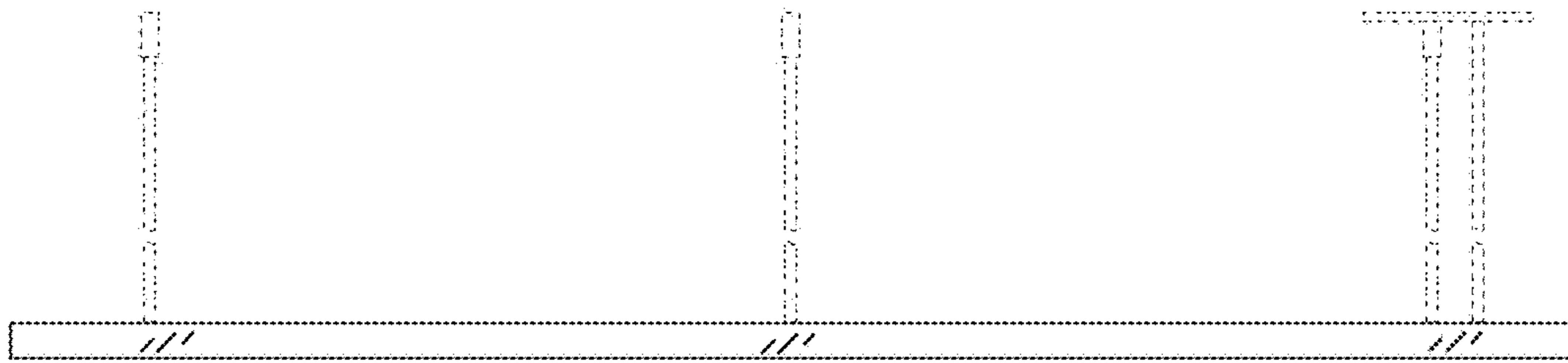

FIG. 85

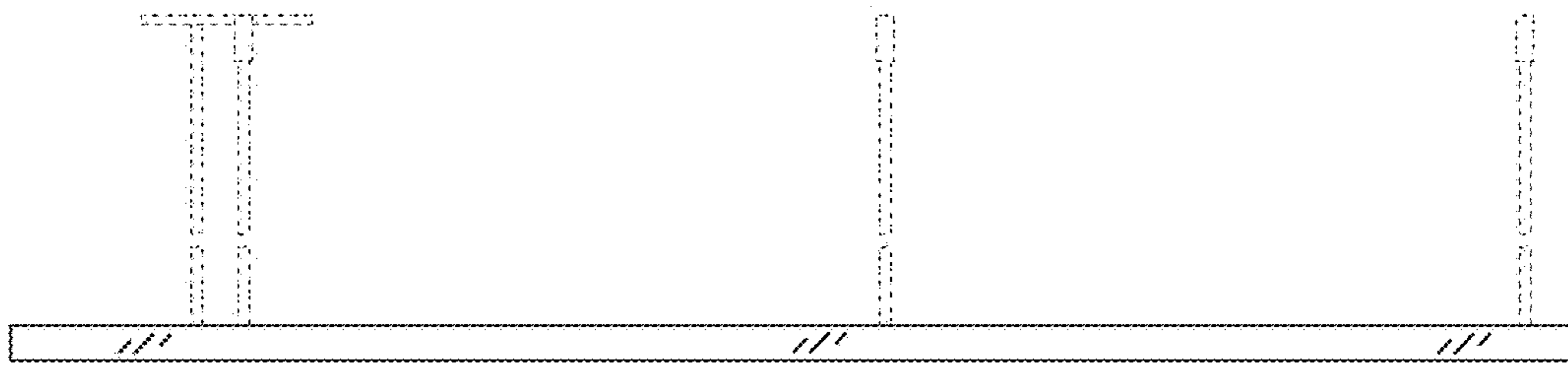

FIG. 86

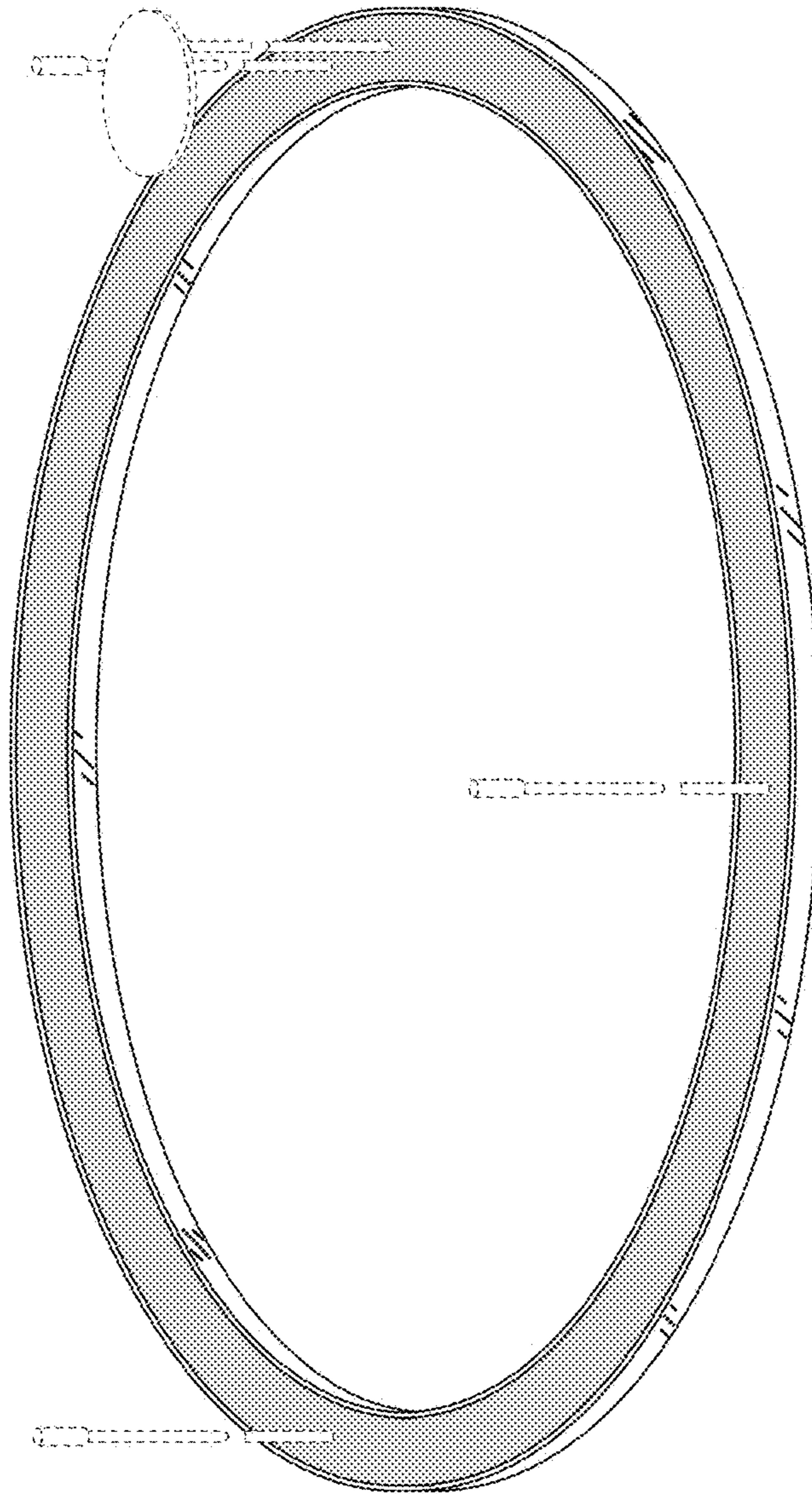

FIG. 87

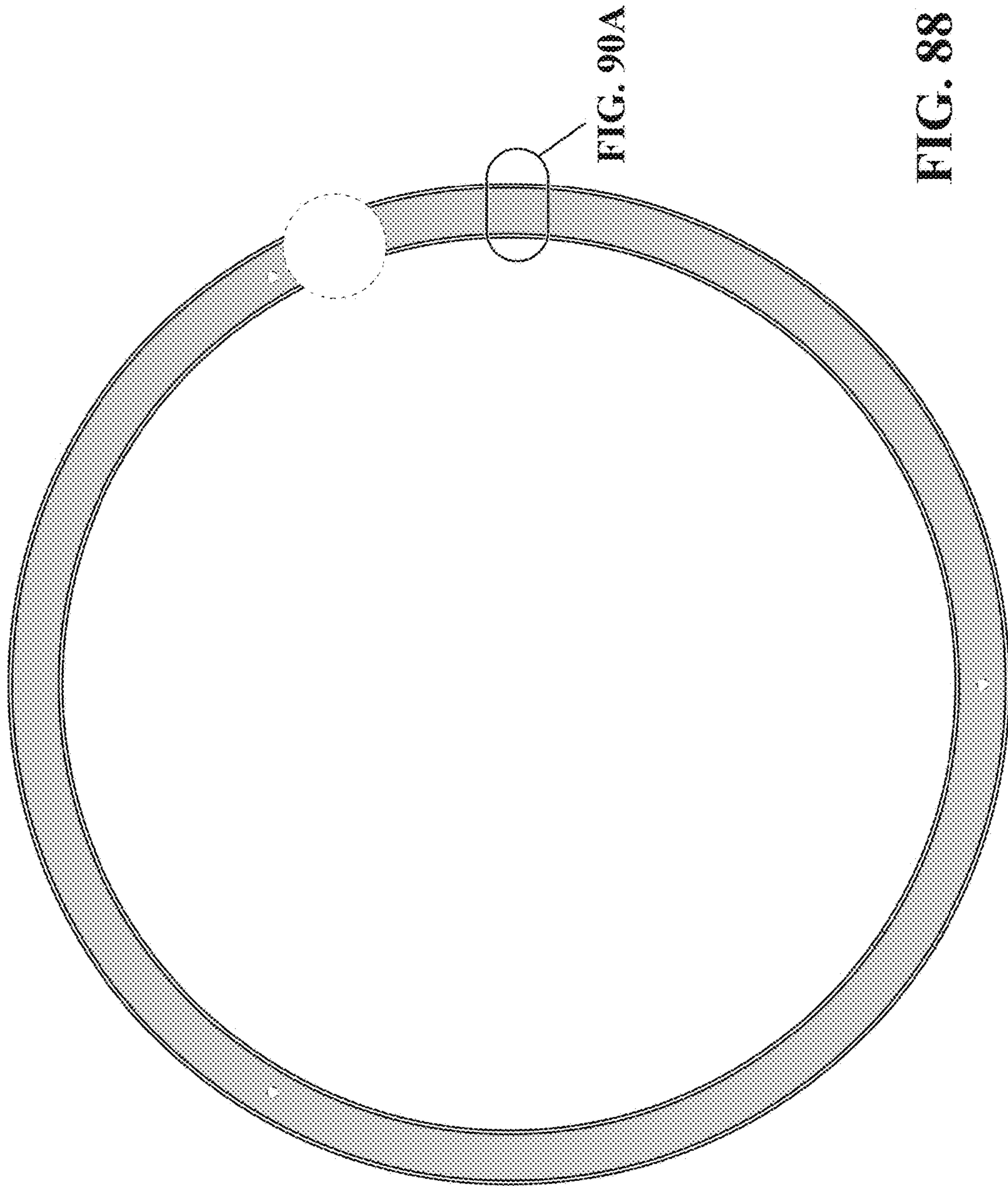
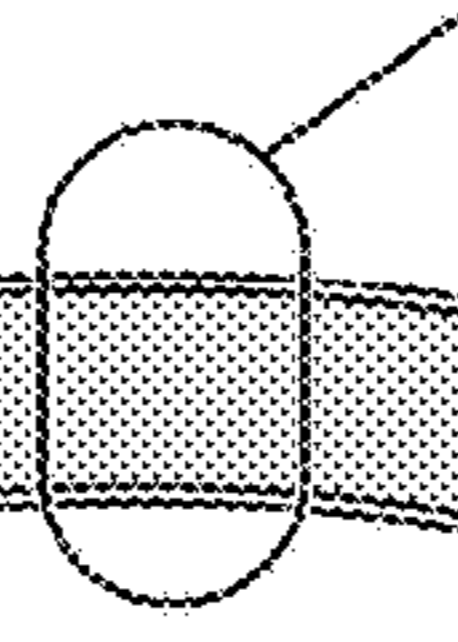
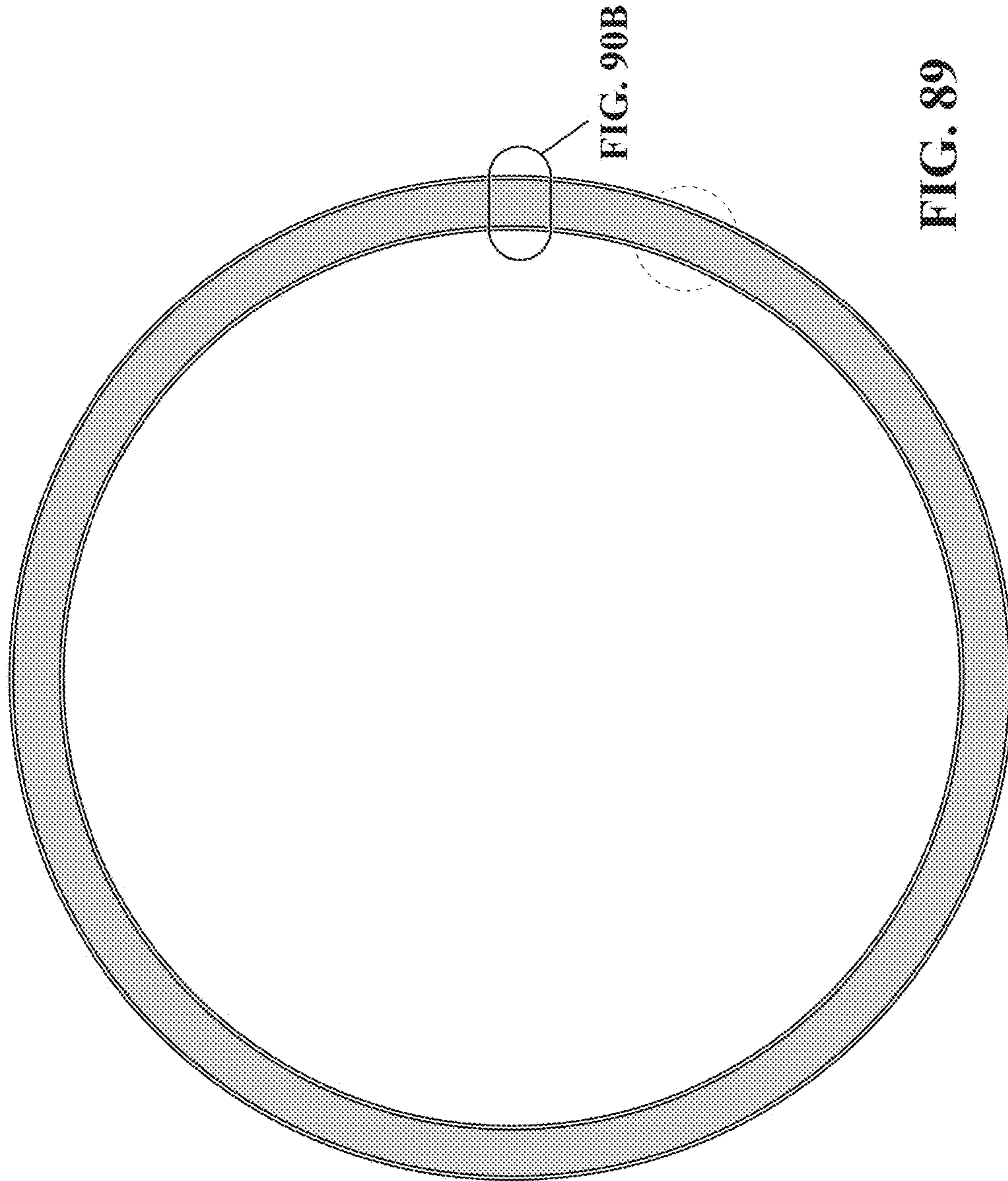

FIG. 90A





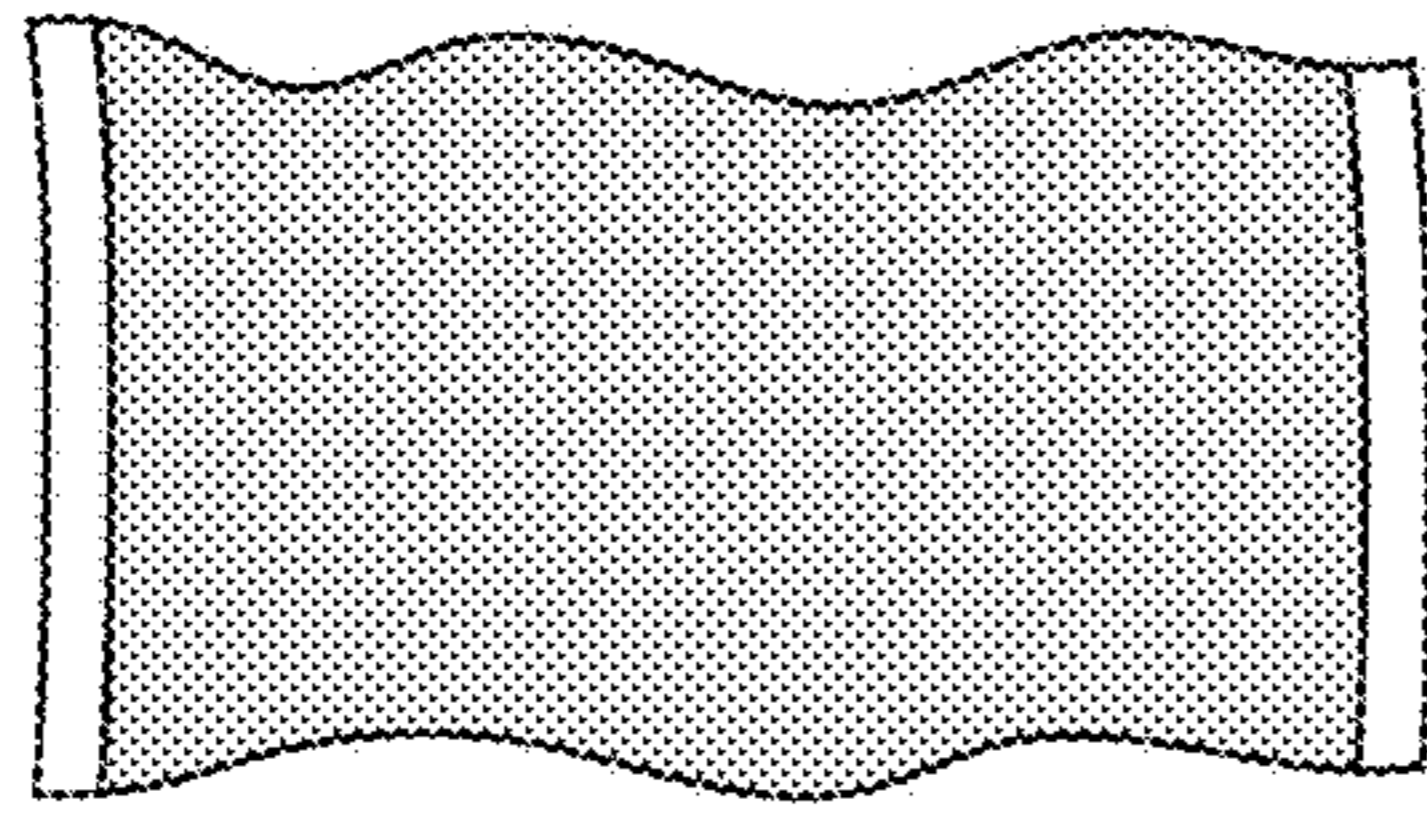

FIG. 90A

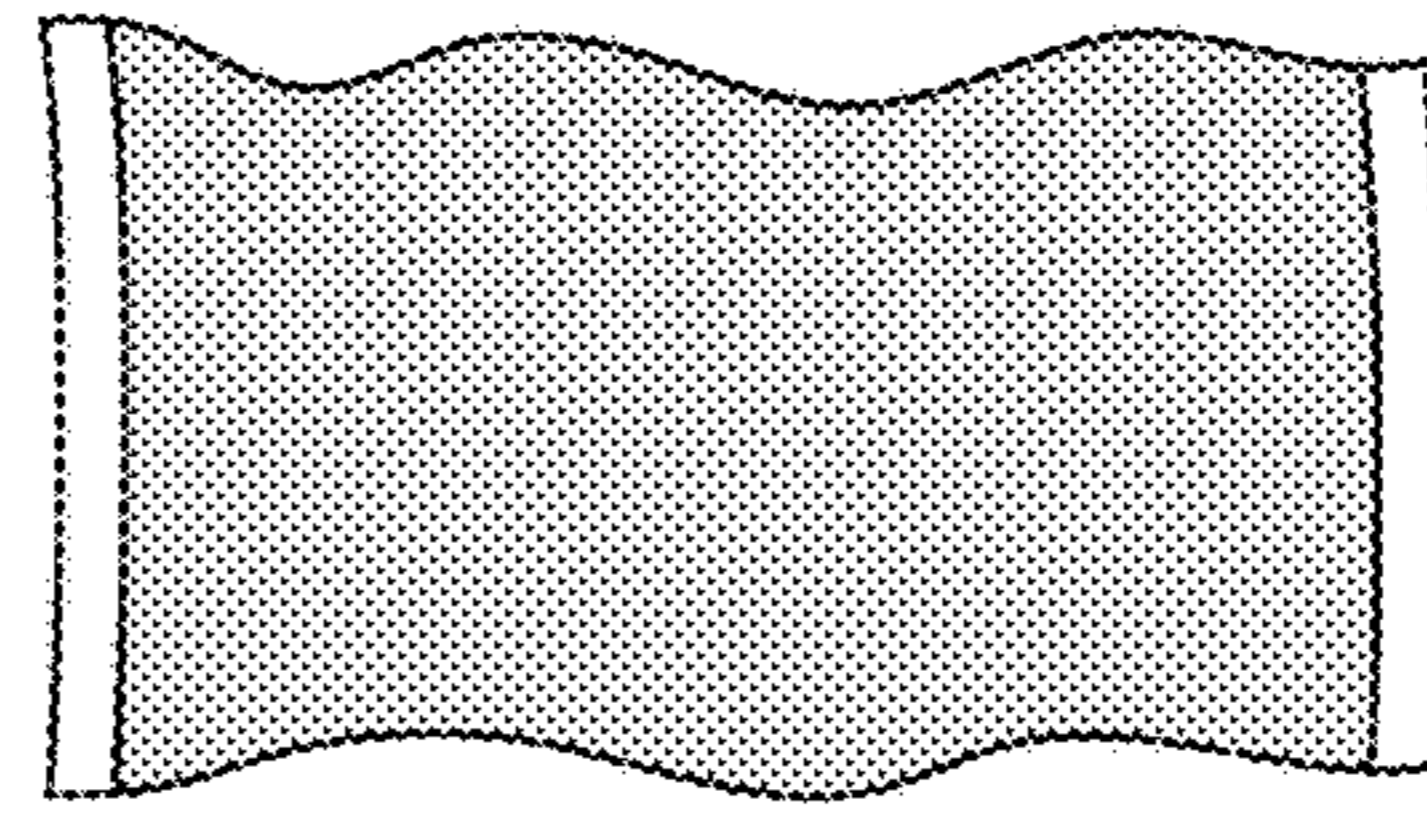

FIG. 90B

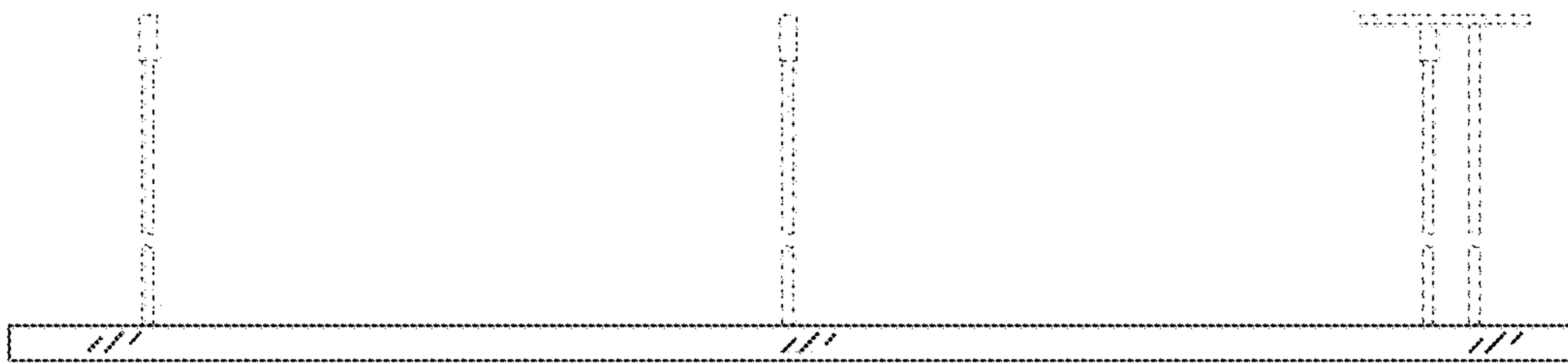

FIG. 91

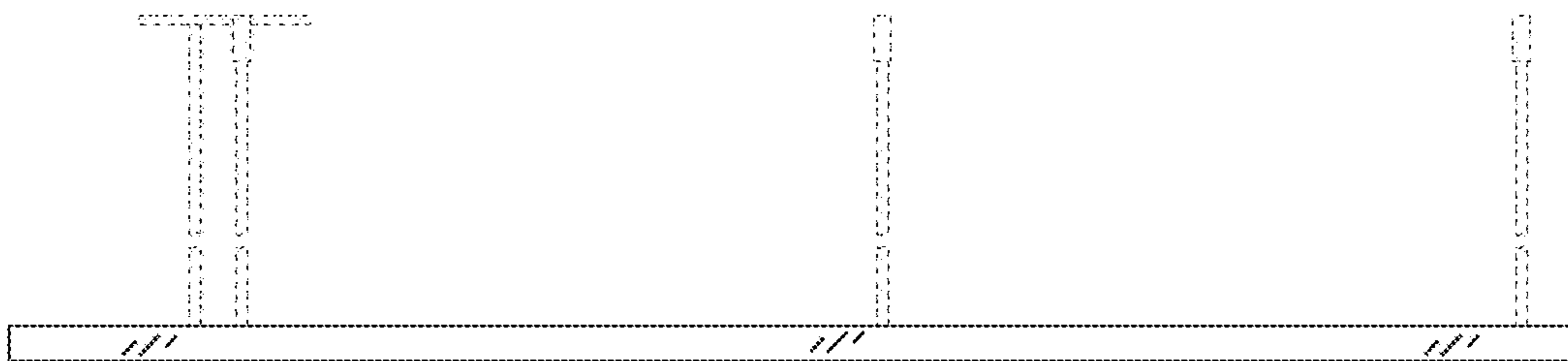

FIG. 92

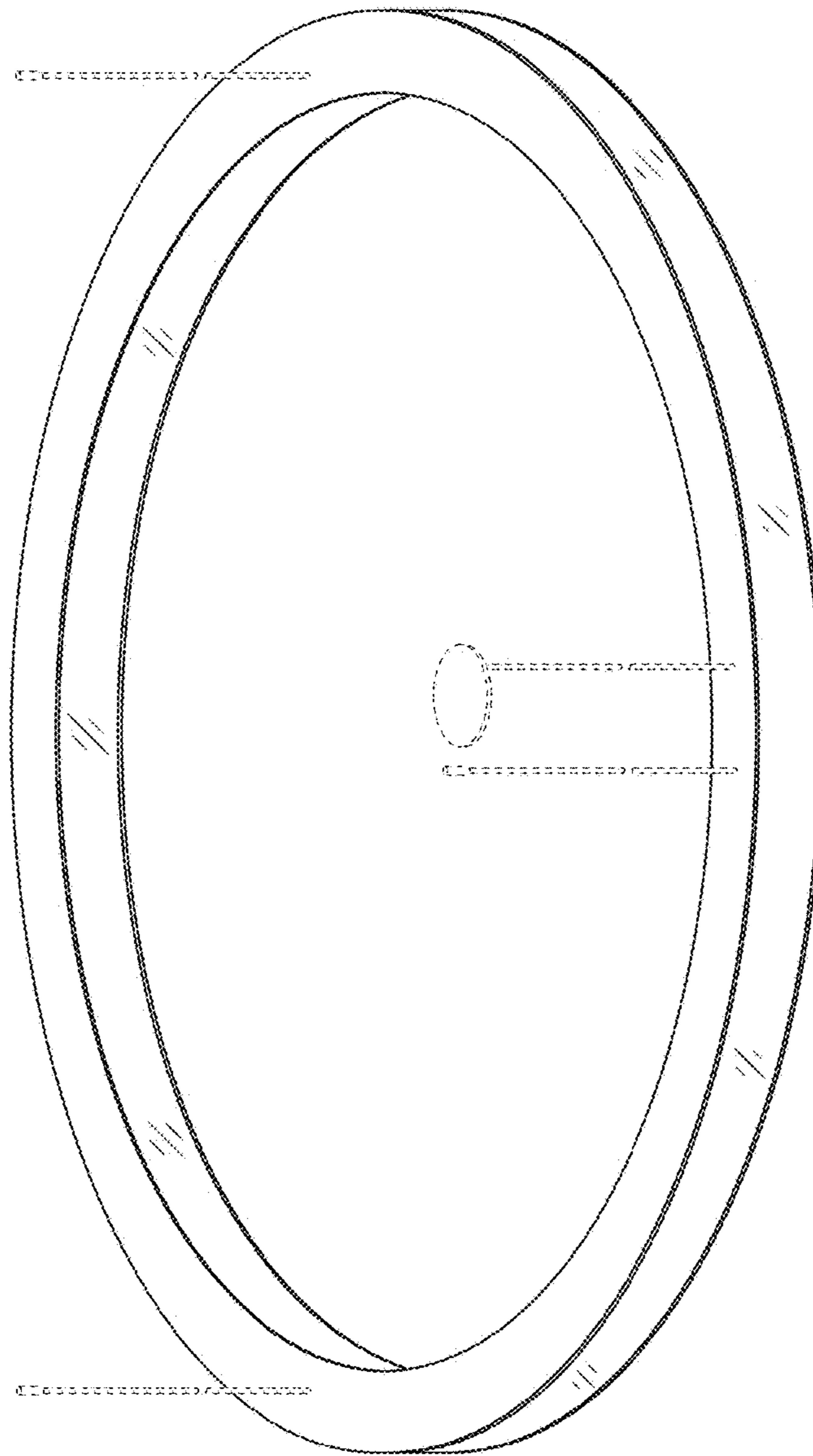

FIG. 93

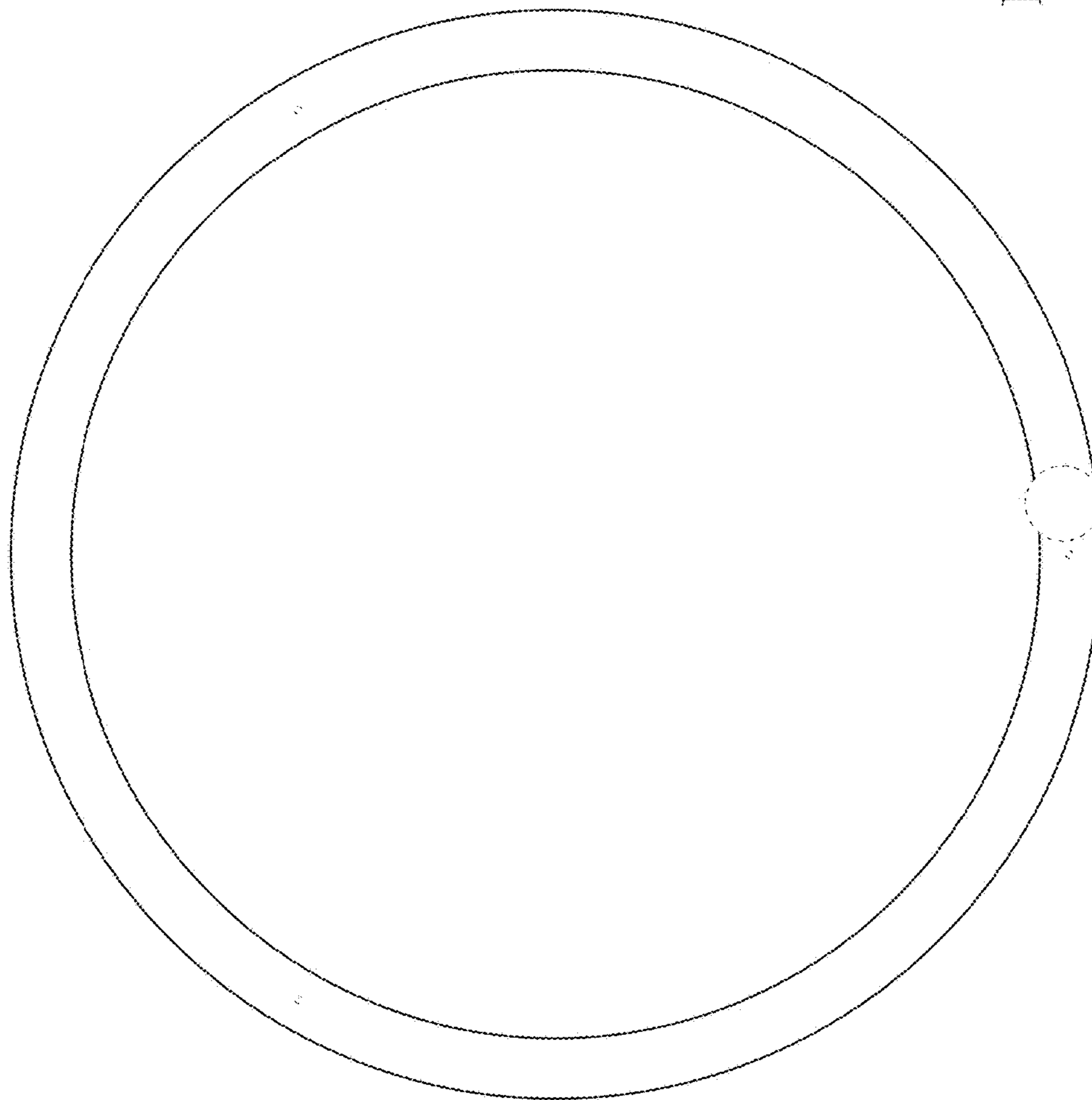

FIG. 94

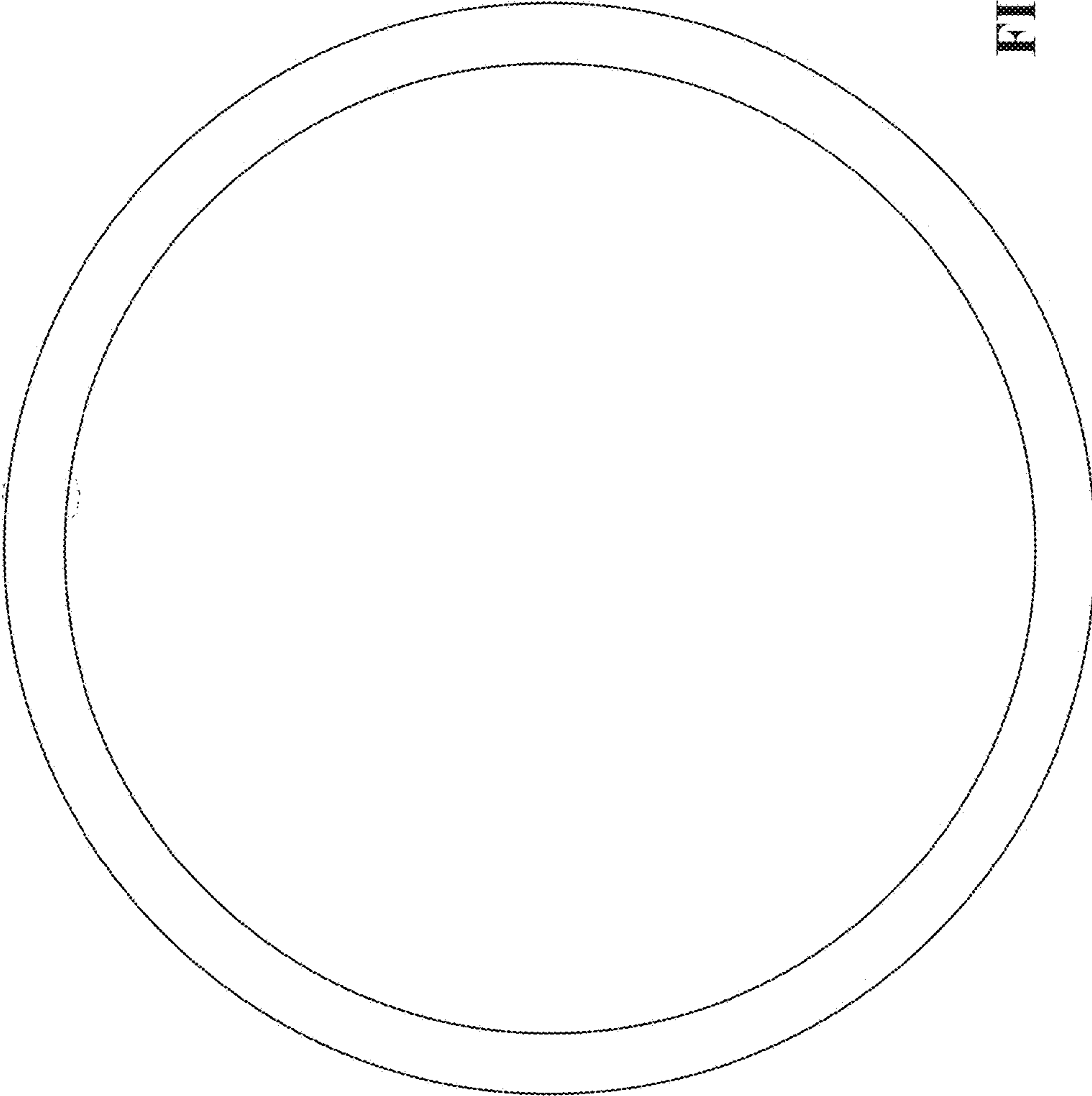

FIG. 95

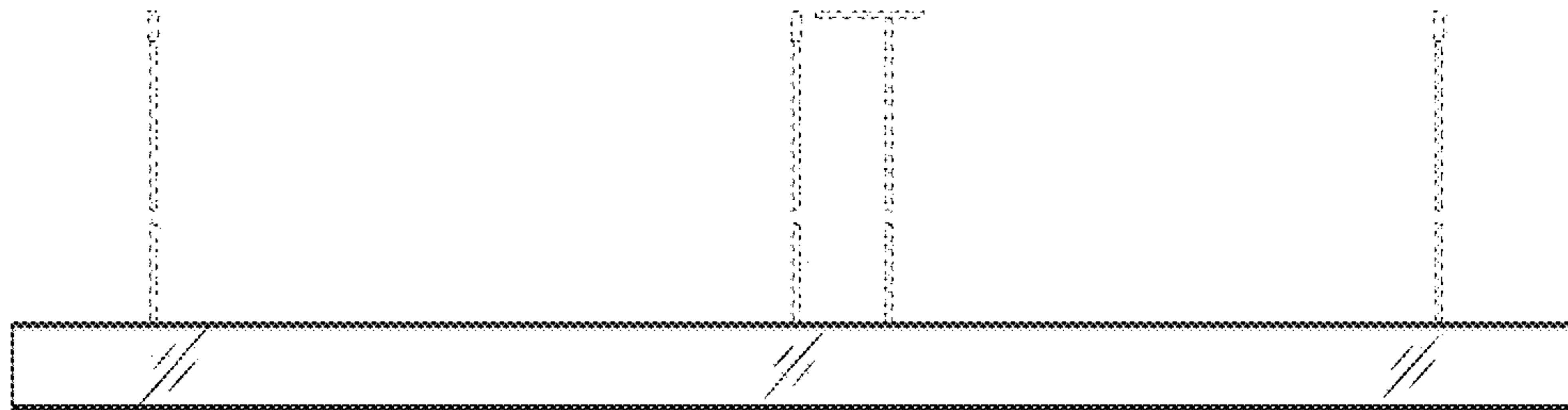

FIG. 96

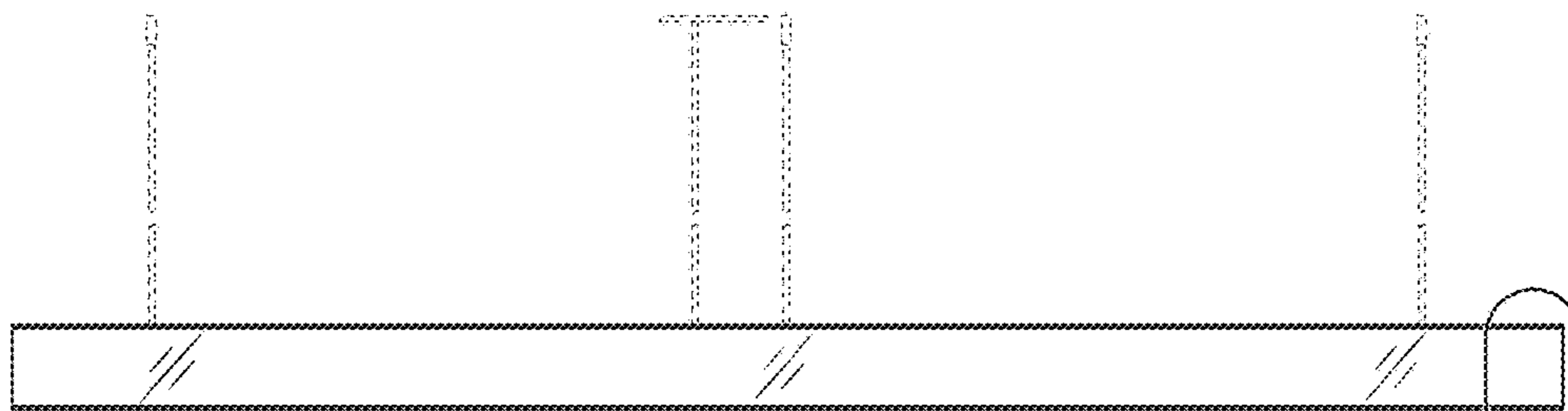

FIG. 97

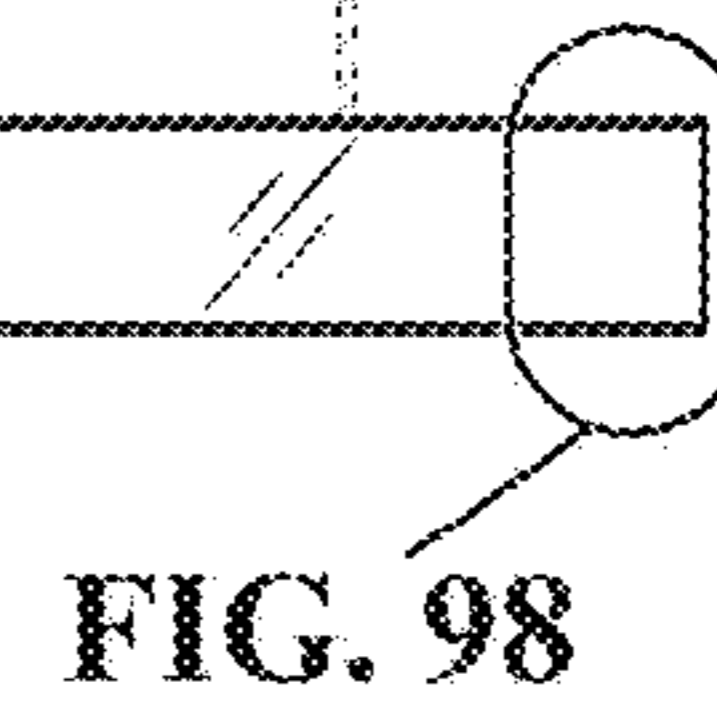

FIG. 98

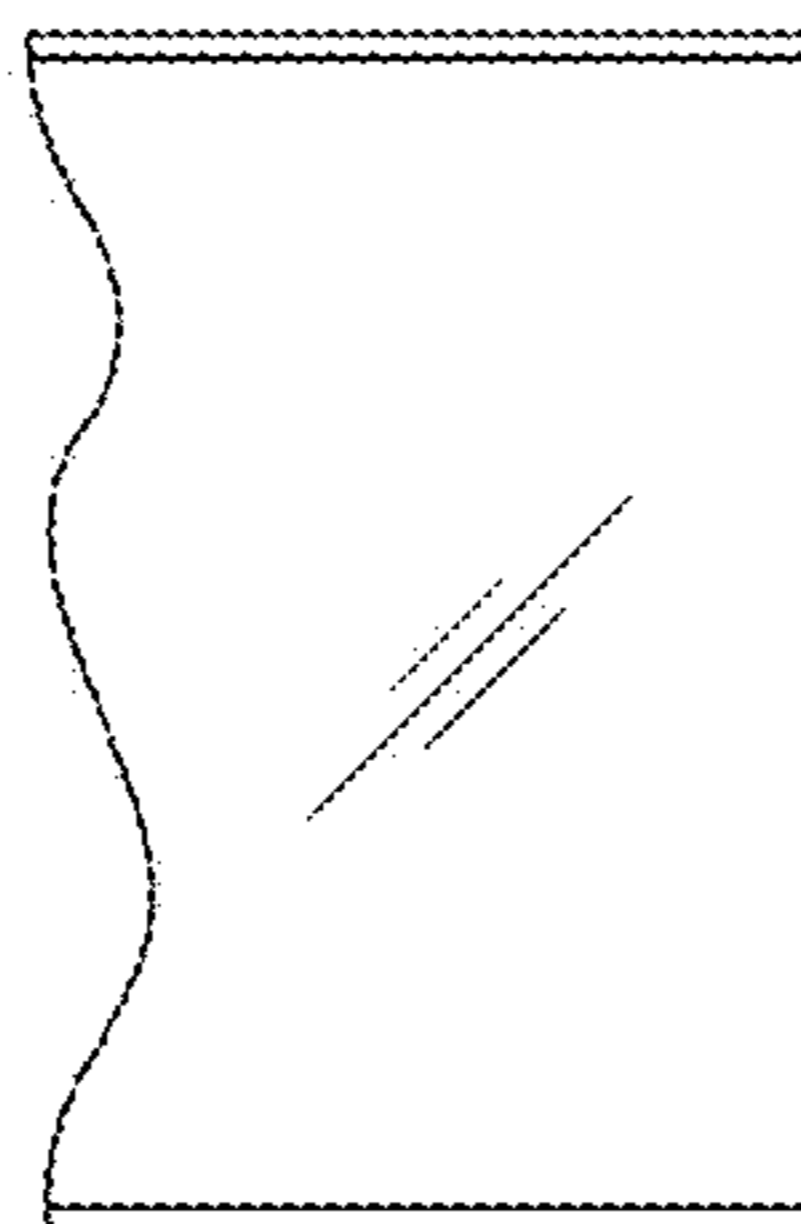

FIG. 98

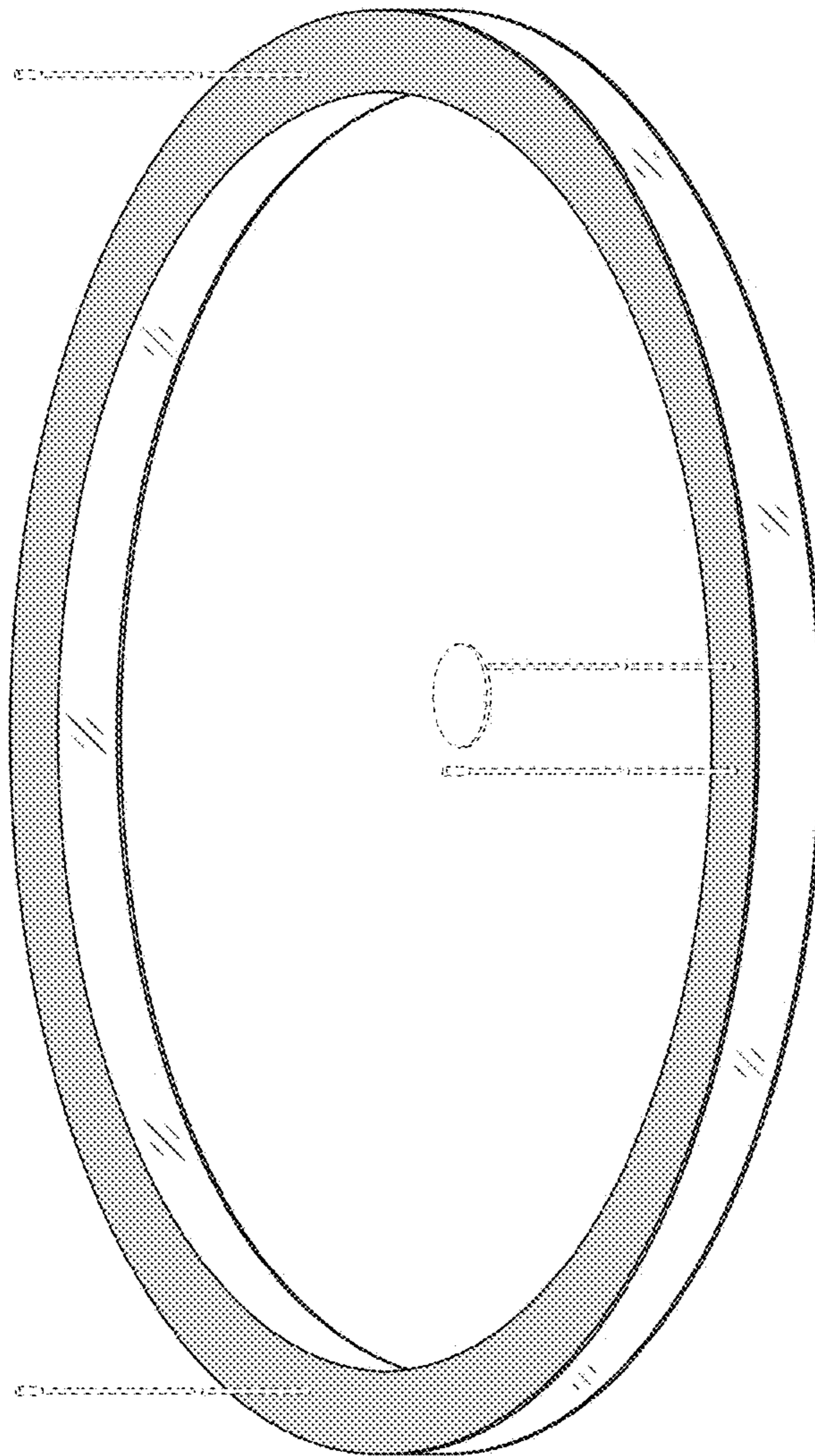

FIG. 99

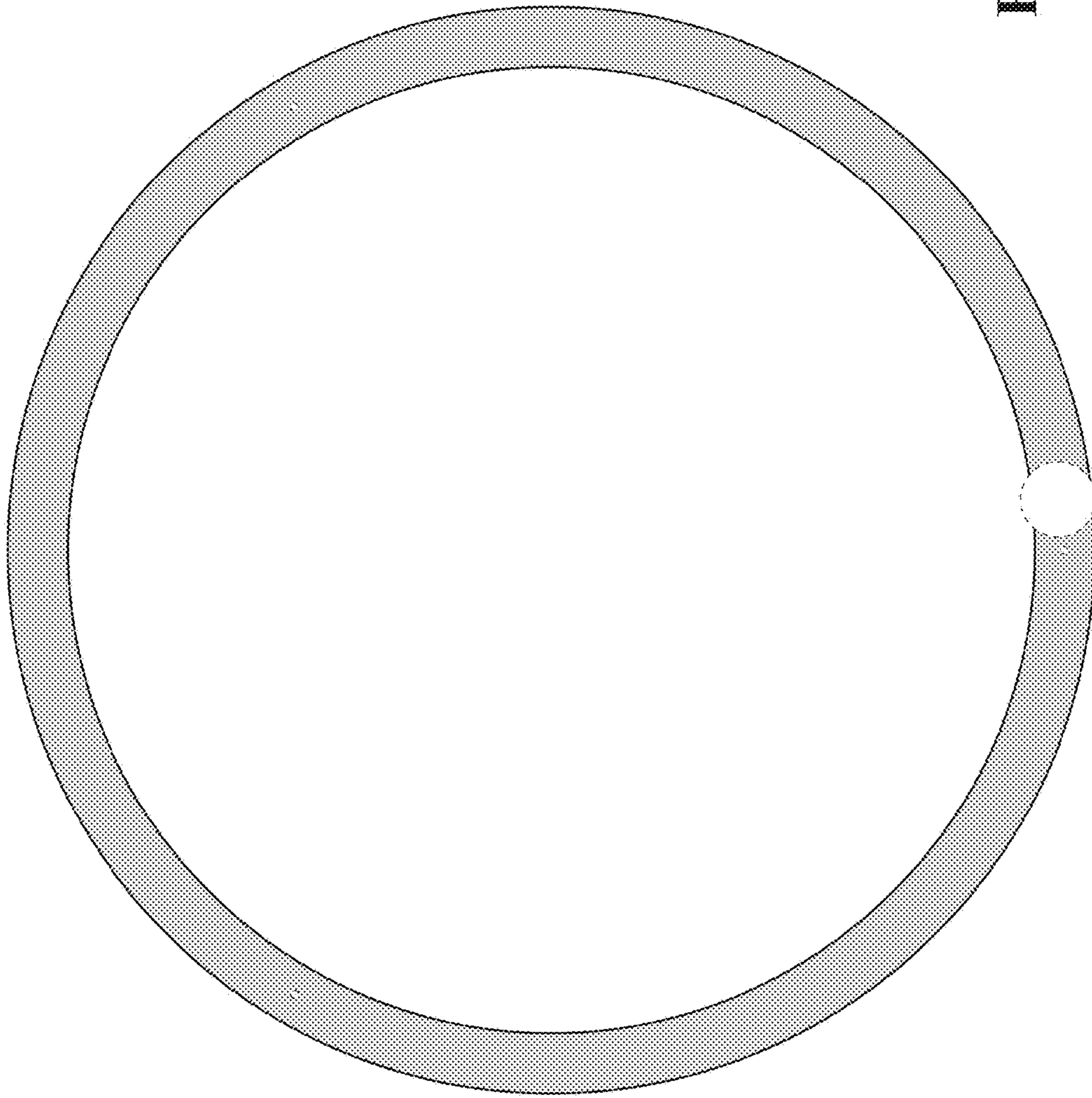

FIG. 100

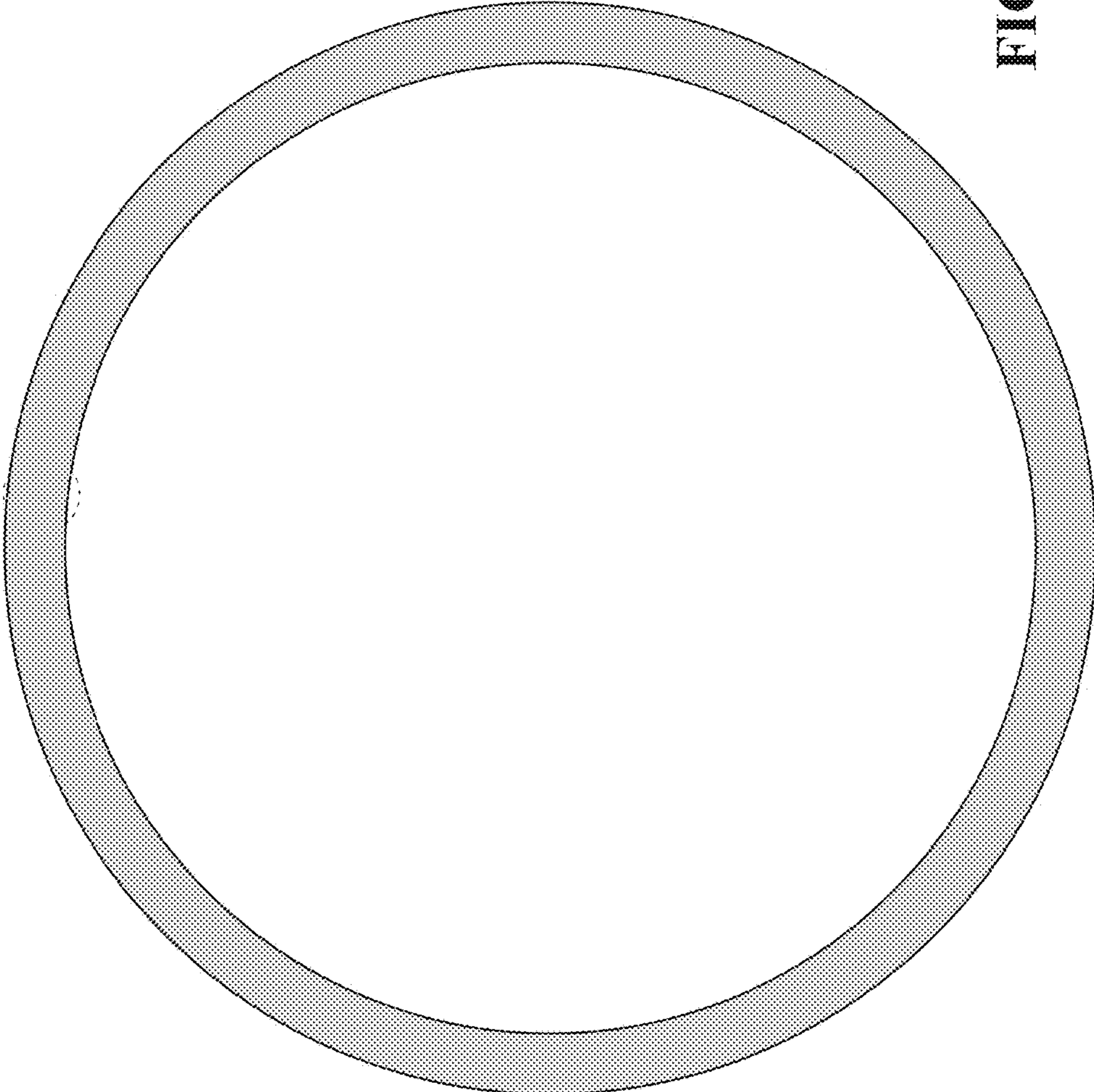

FIG. 101

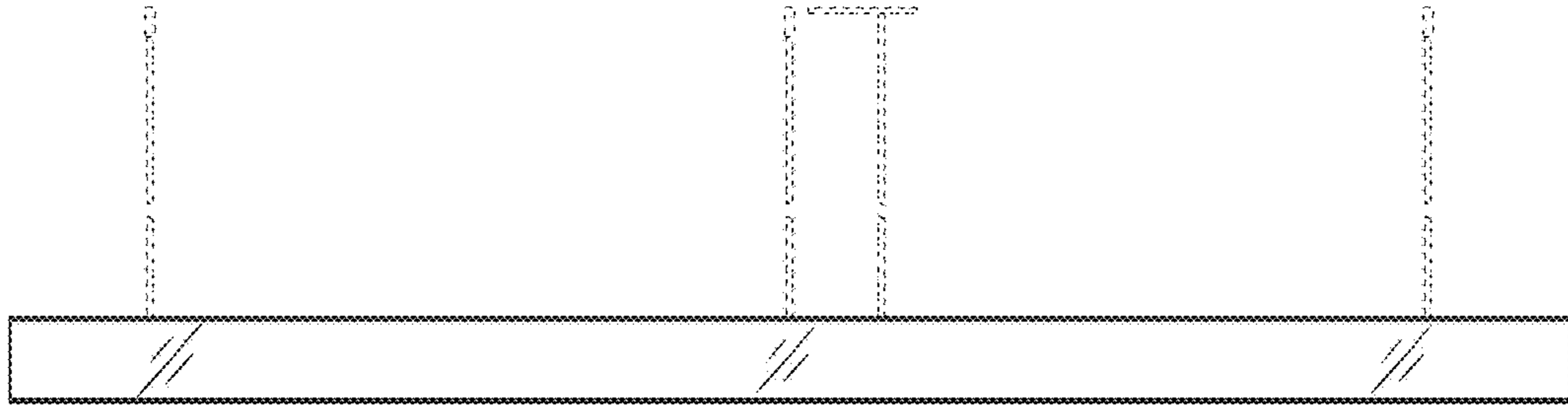

FIG. 102

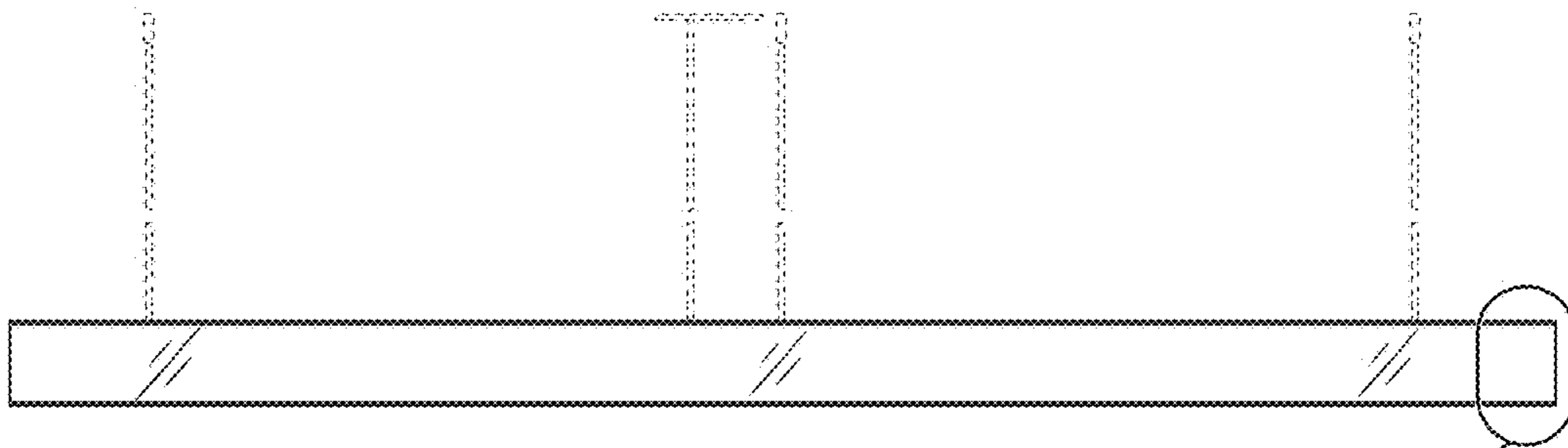

FIG. 103

FIG. 104

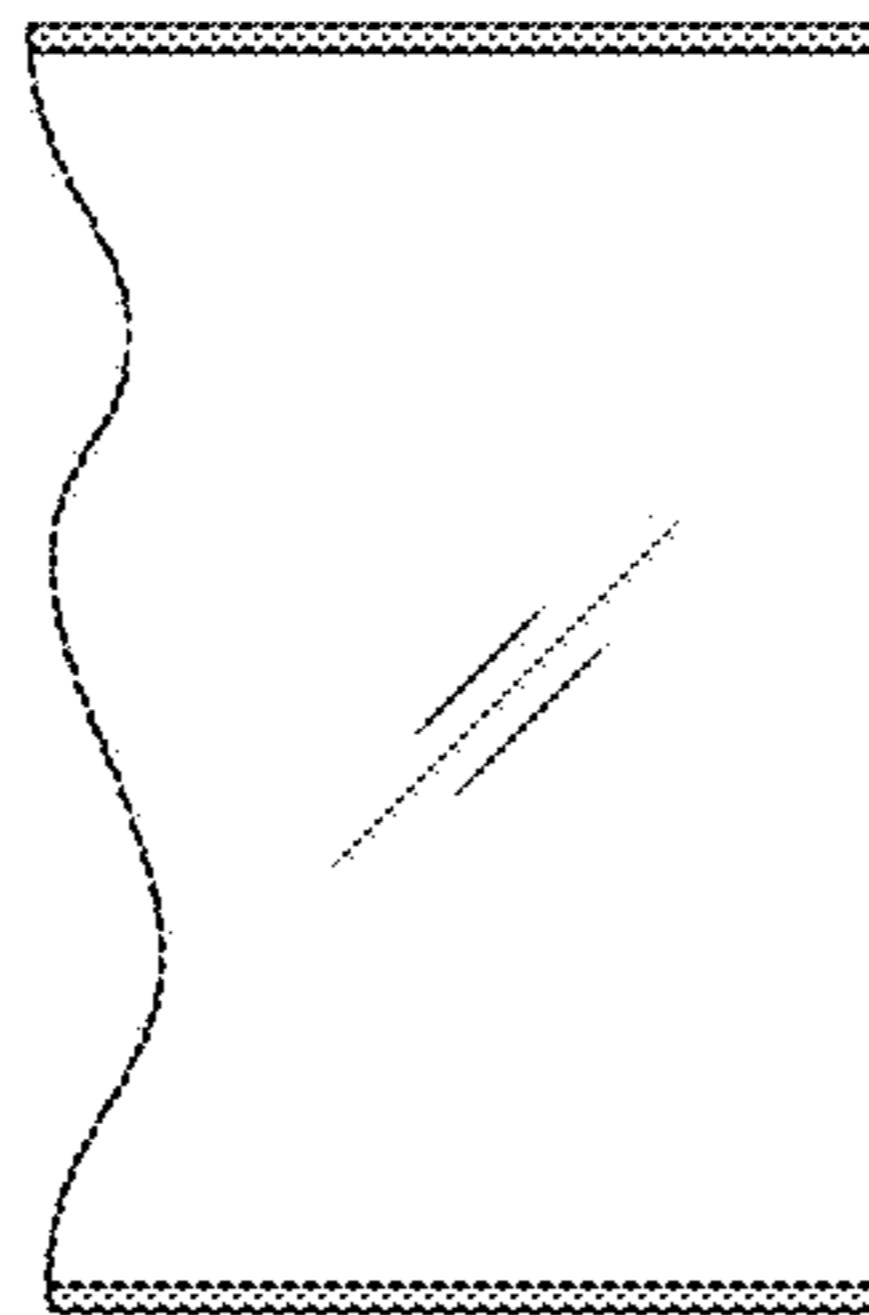

FIG. 104

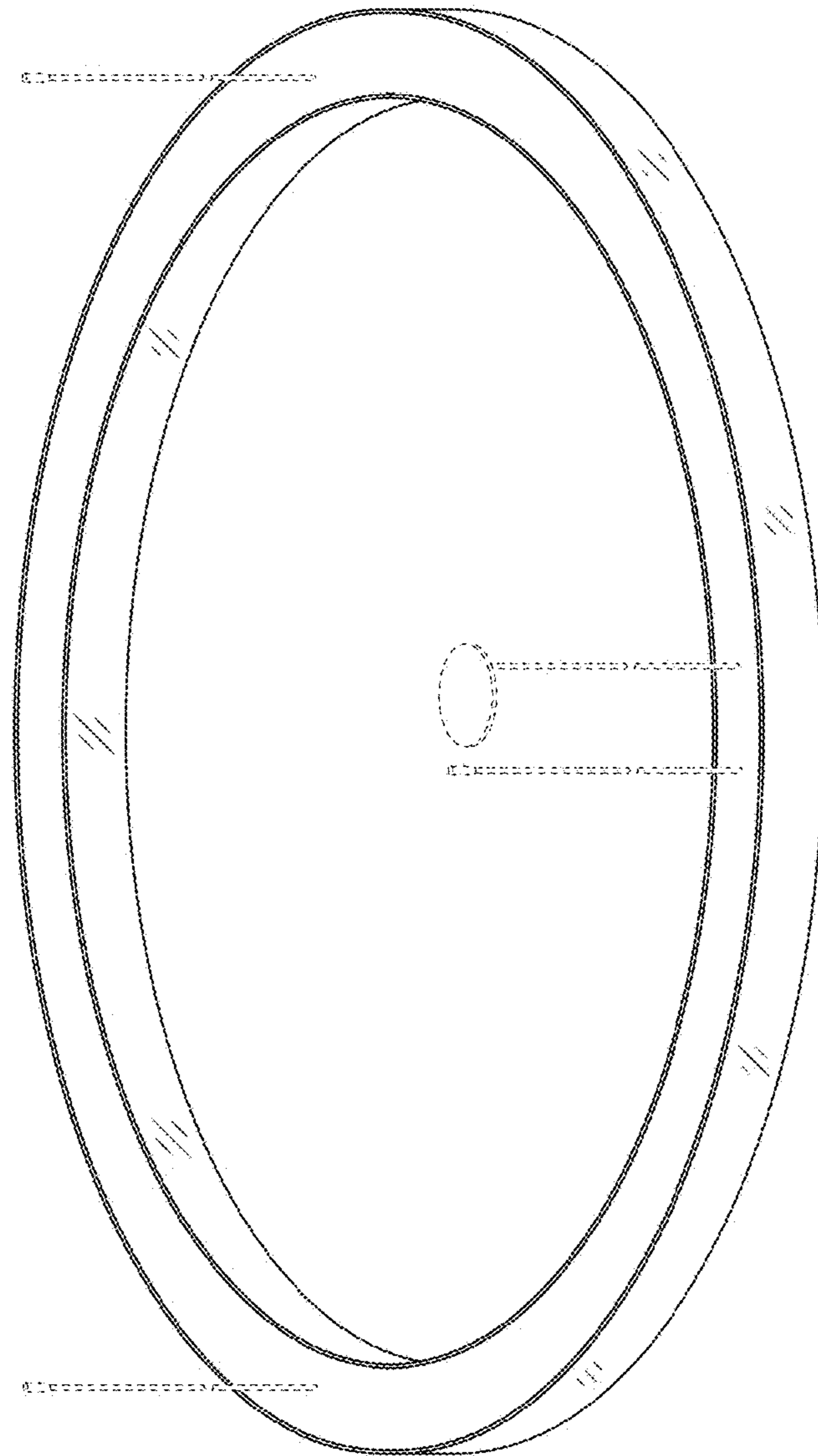

FIG. 105

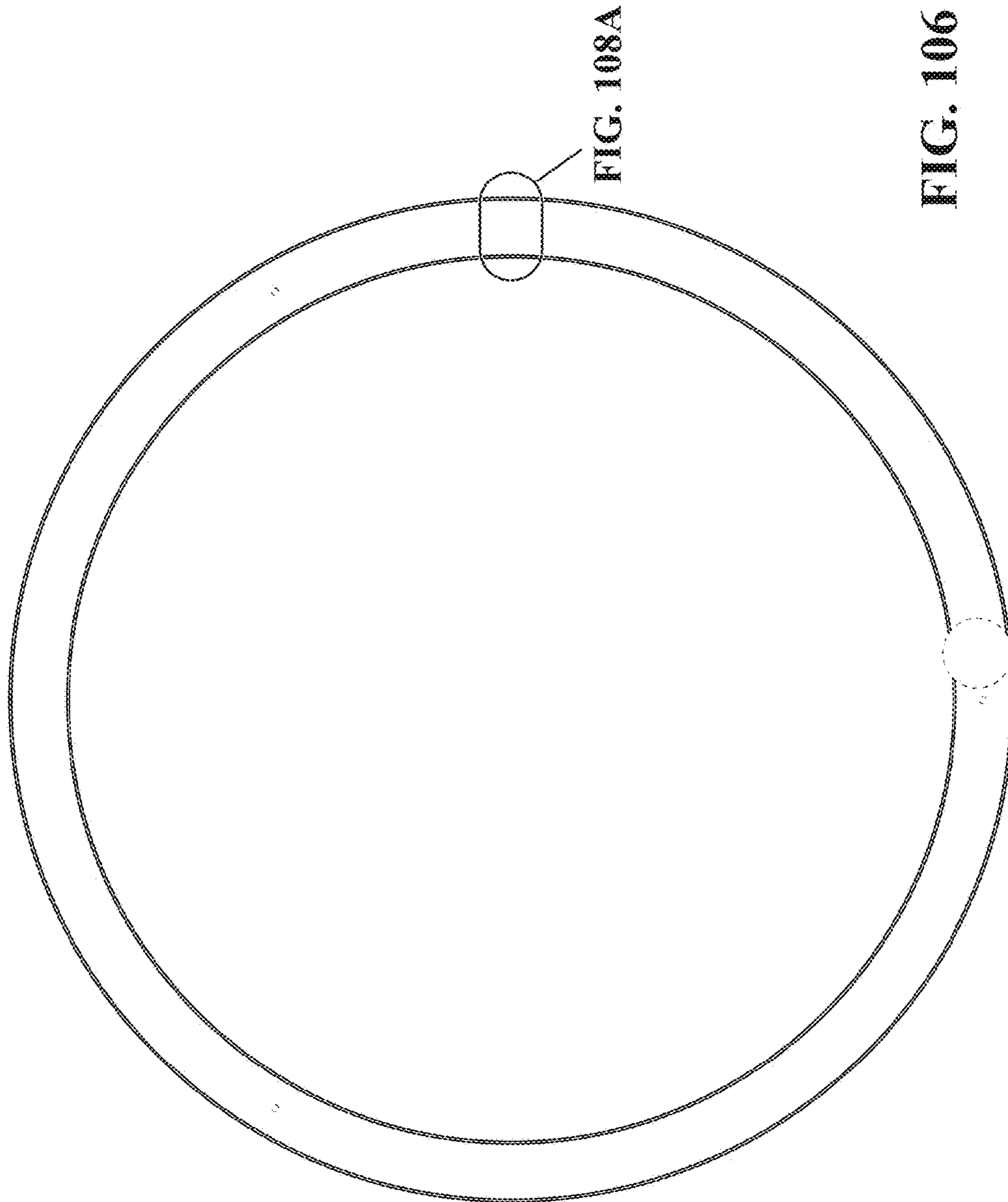

FIG. 108A

FIG. 106

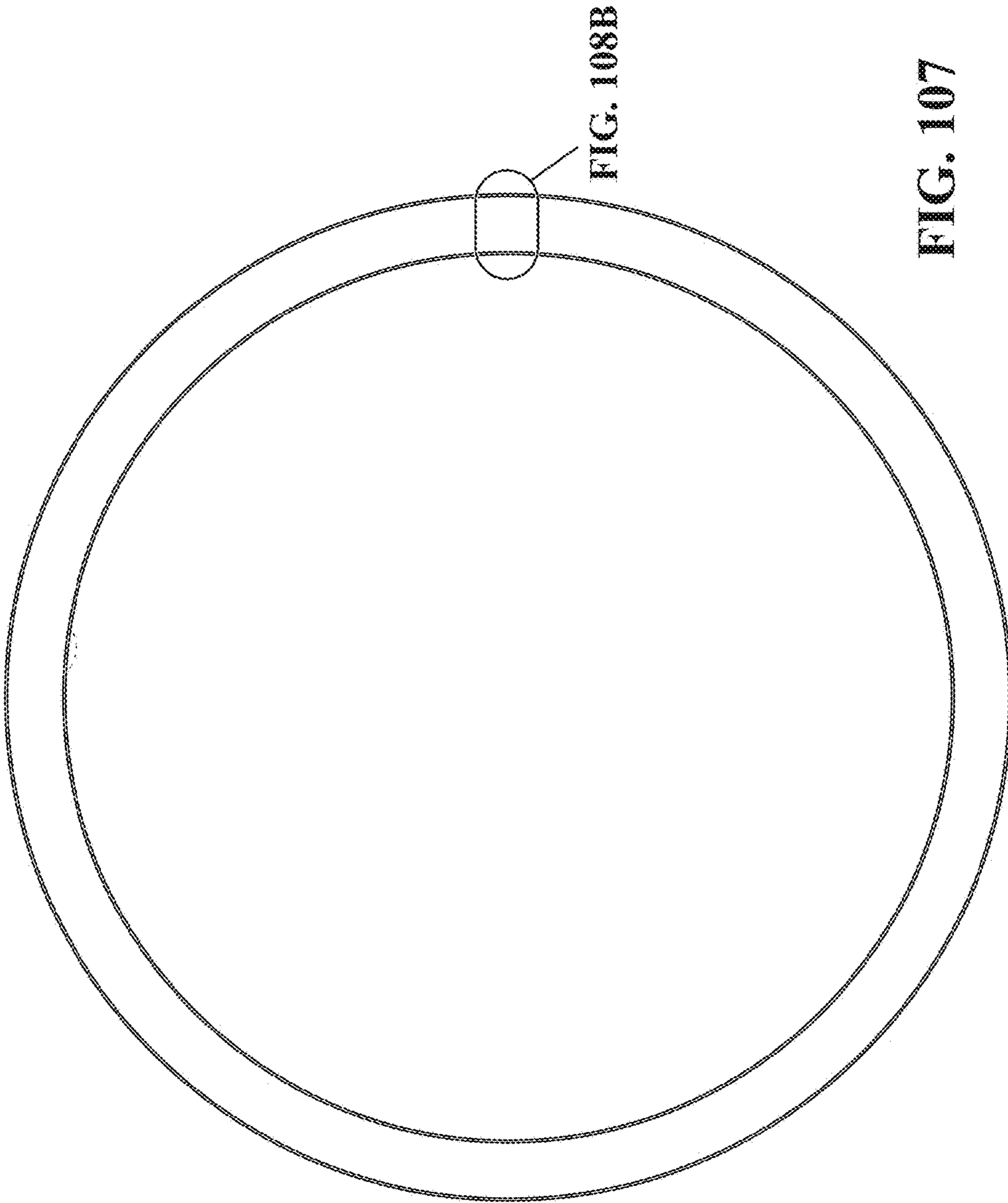

FIG. 108B

FIG. 107

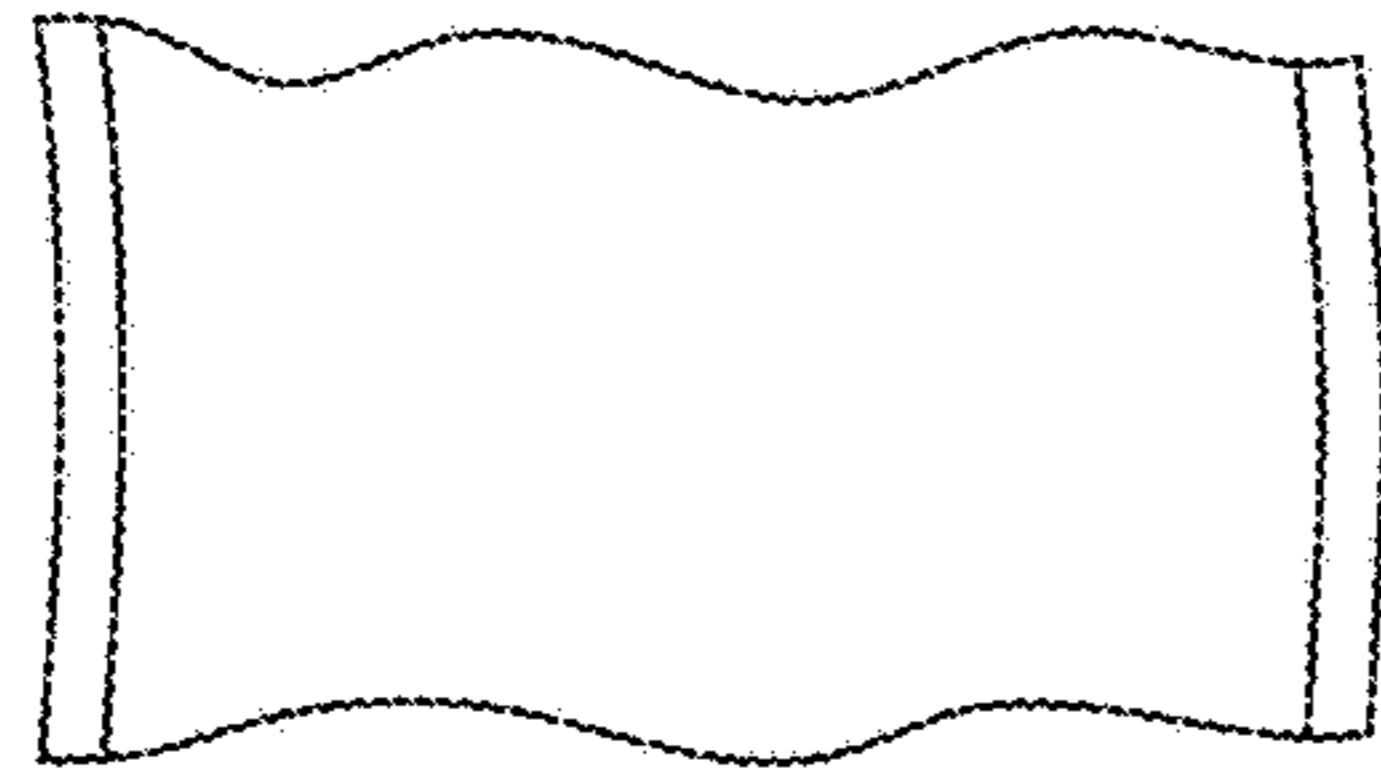

FIG. 108A

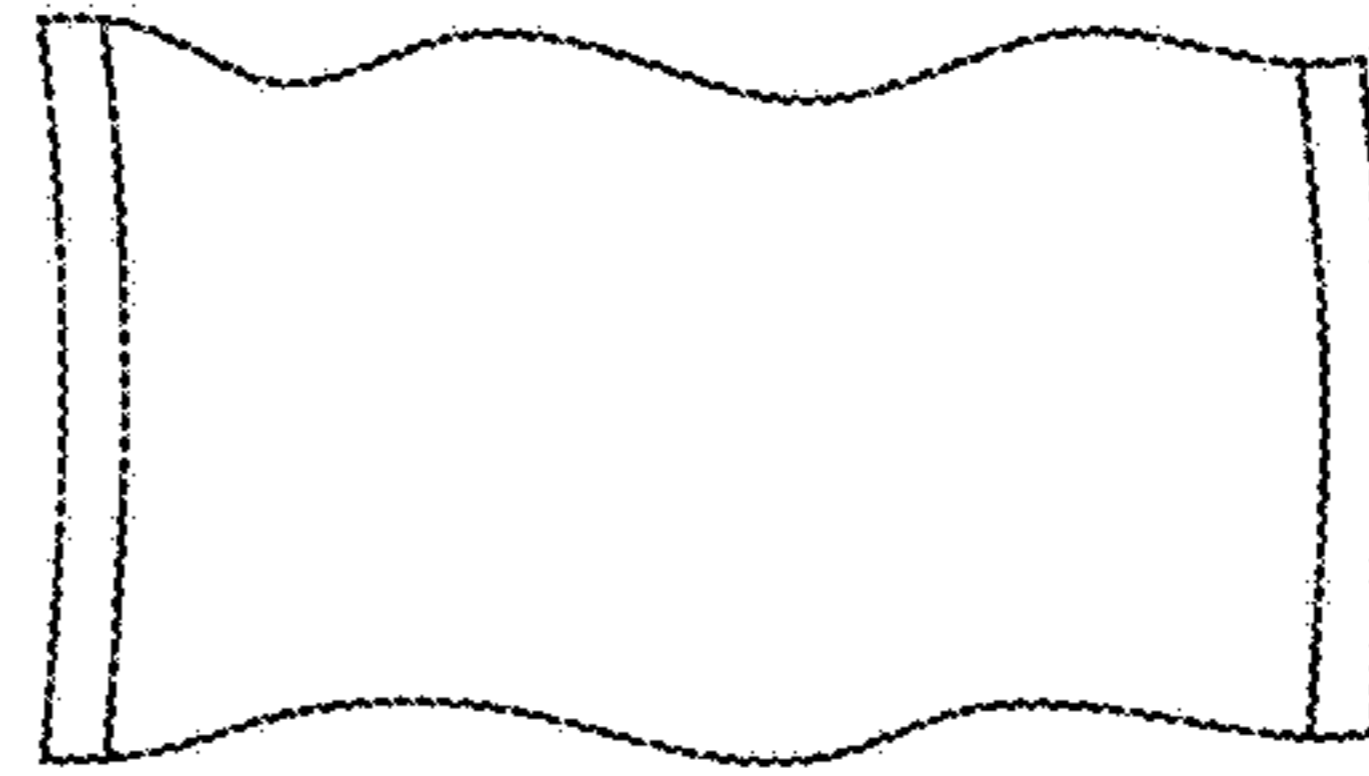

FIG. 108B

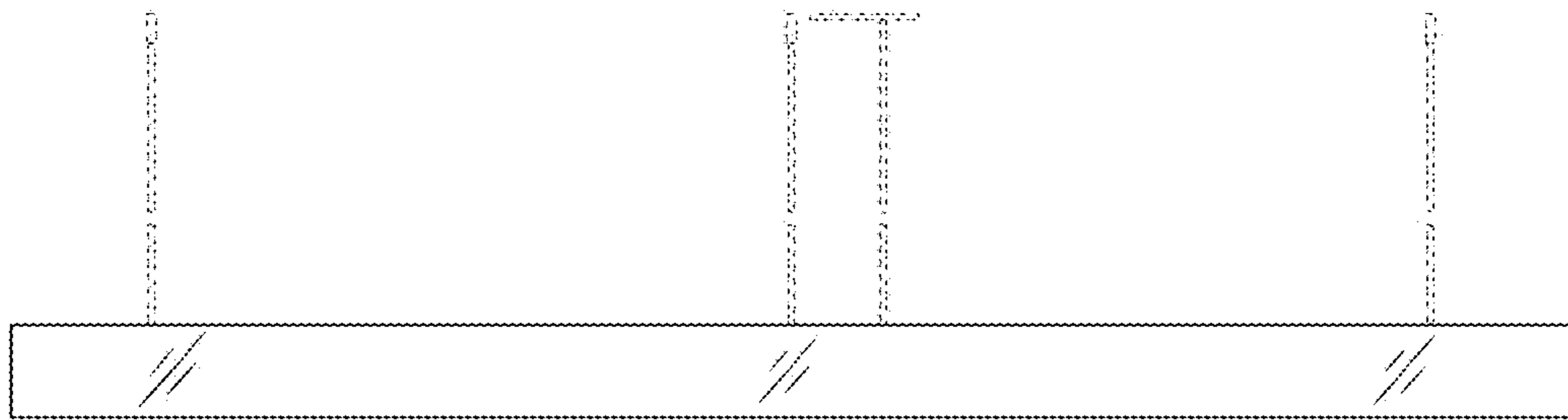

FIG. 109

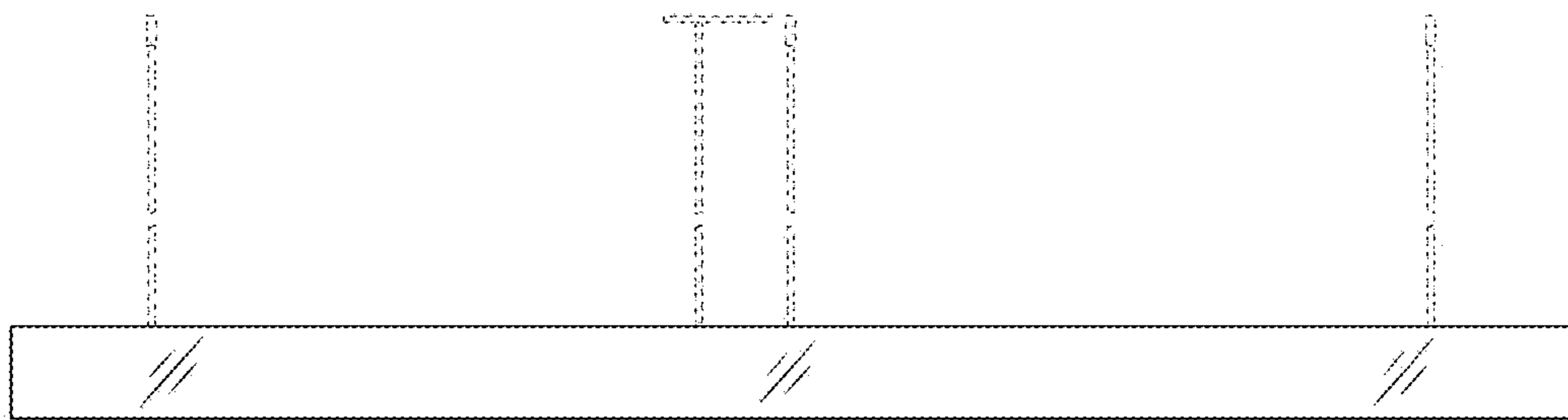

FIG. 110

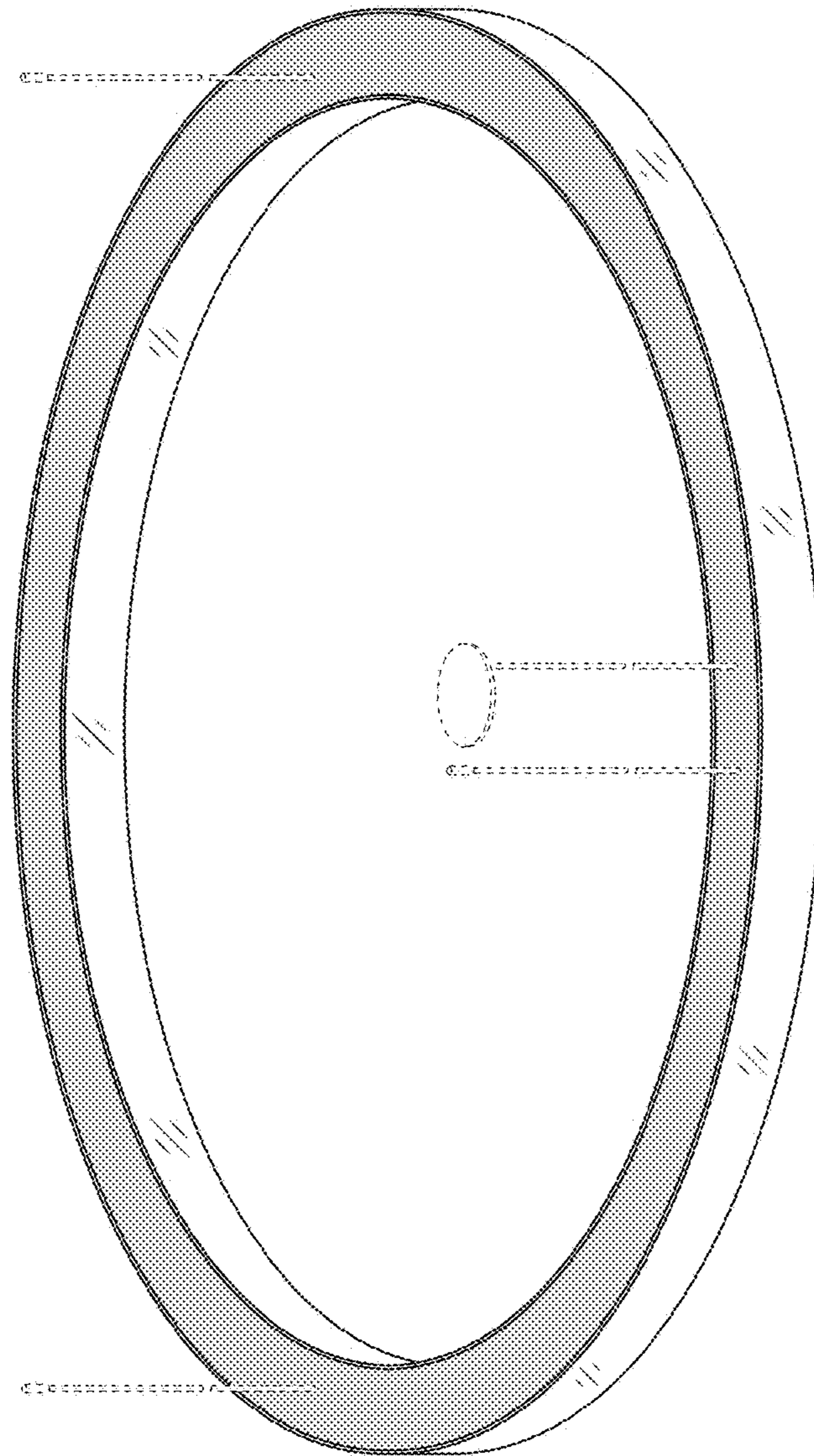
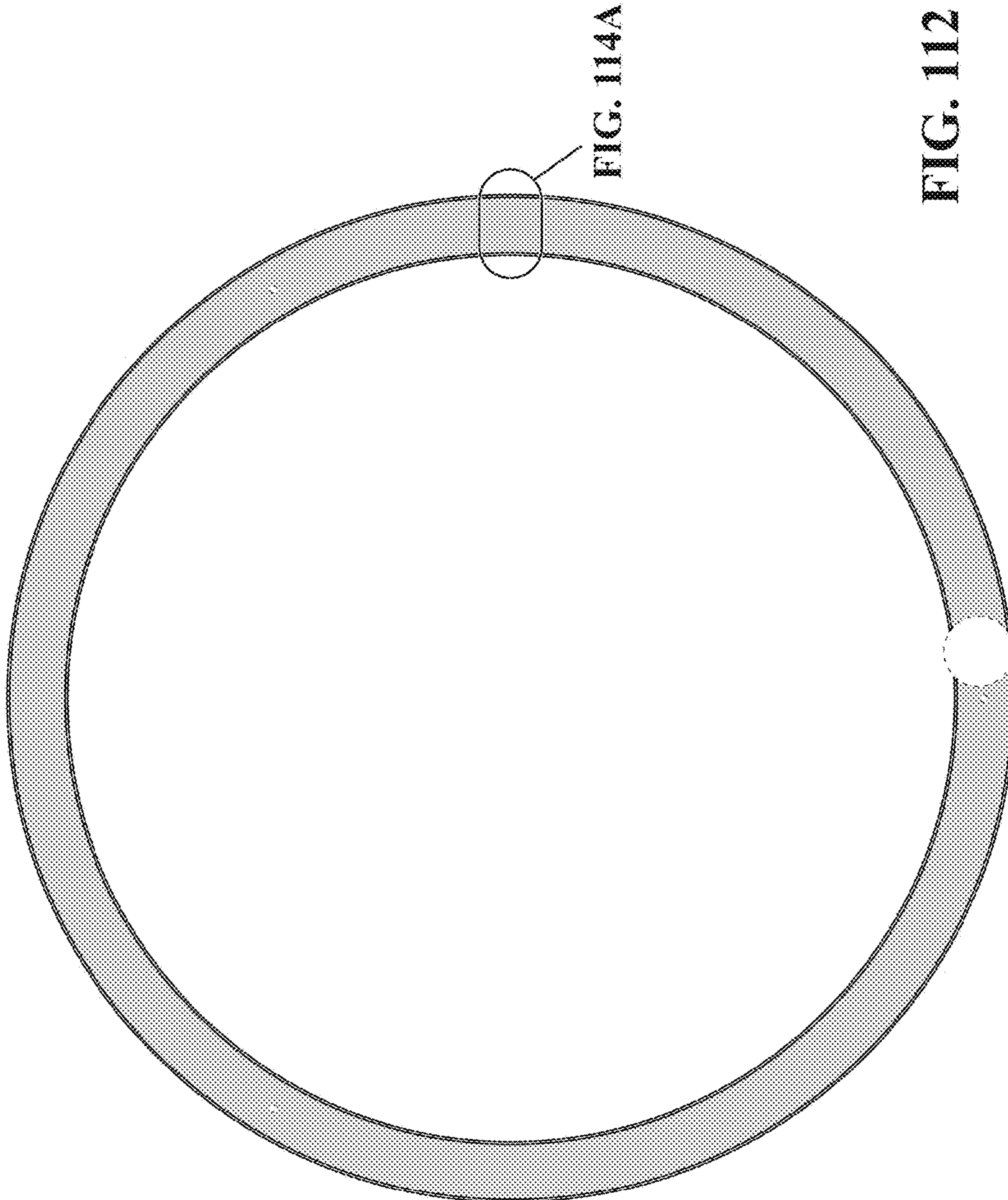
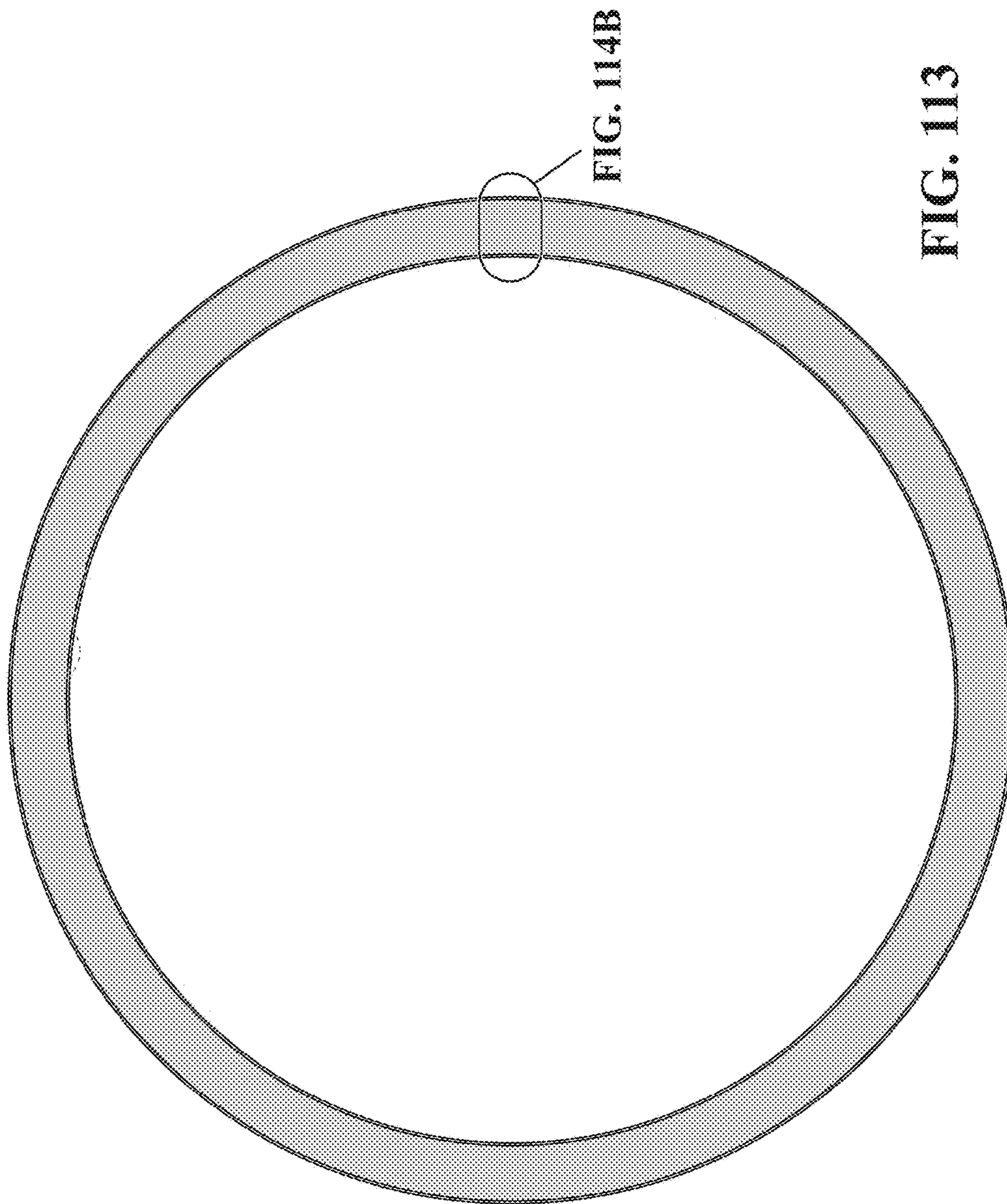

FIG. 111





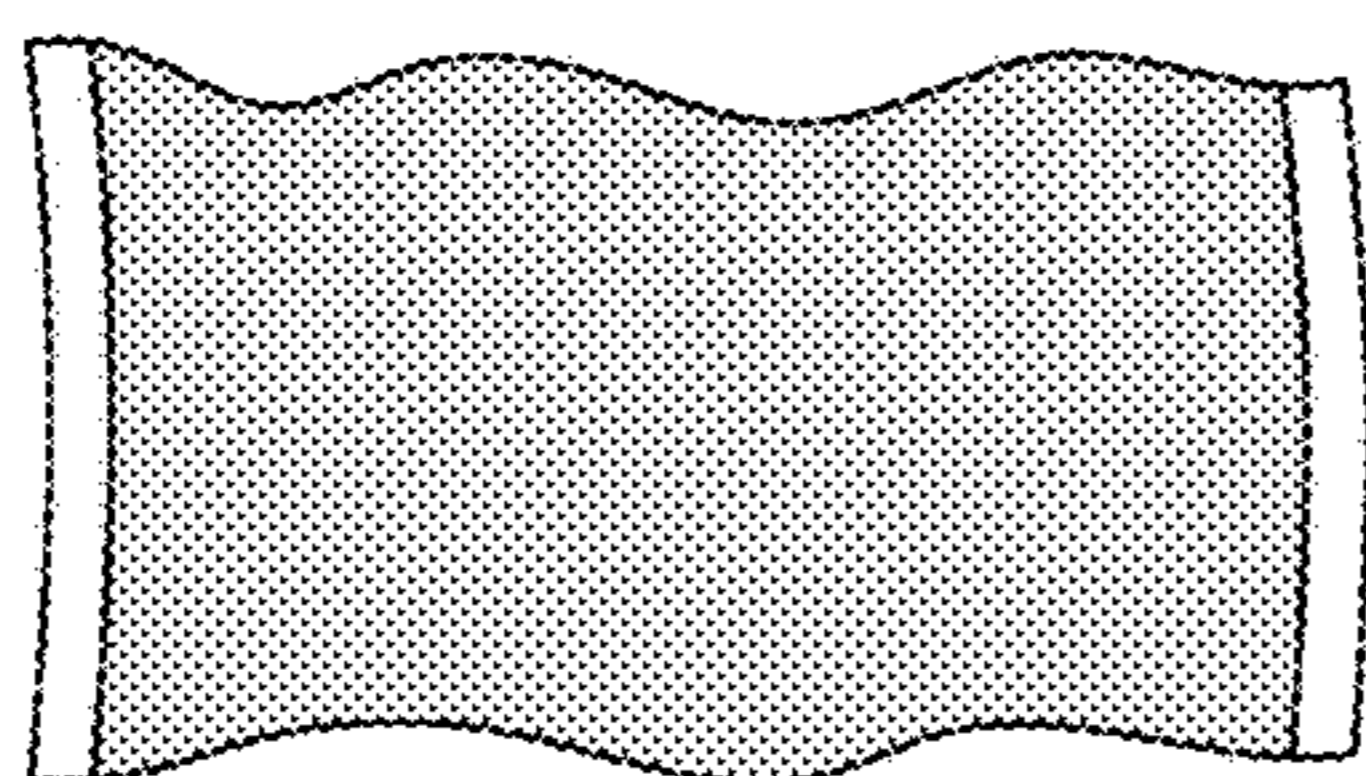

FIG. 114A

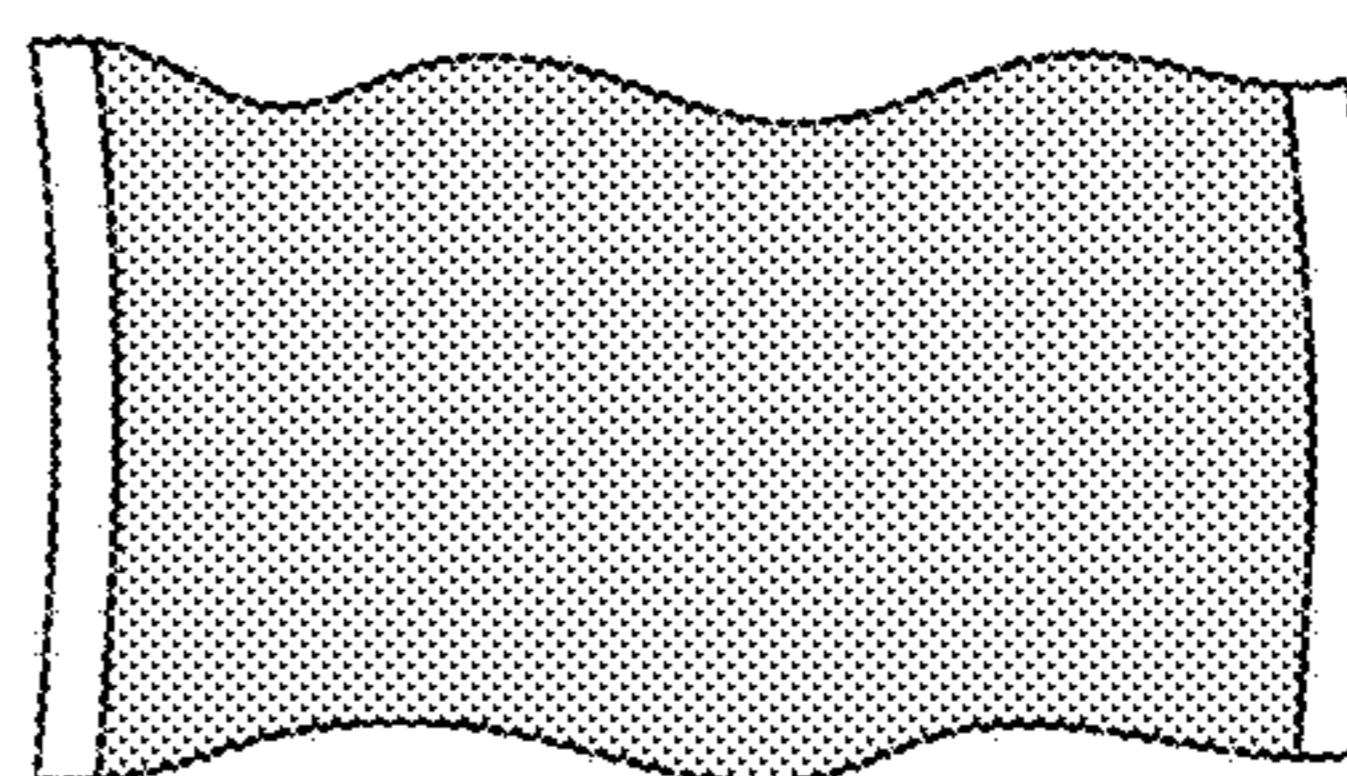

FIG. 114B

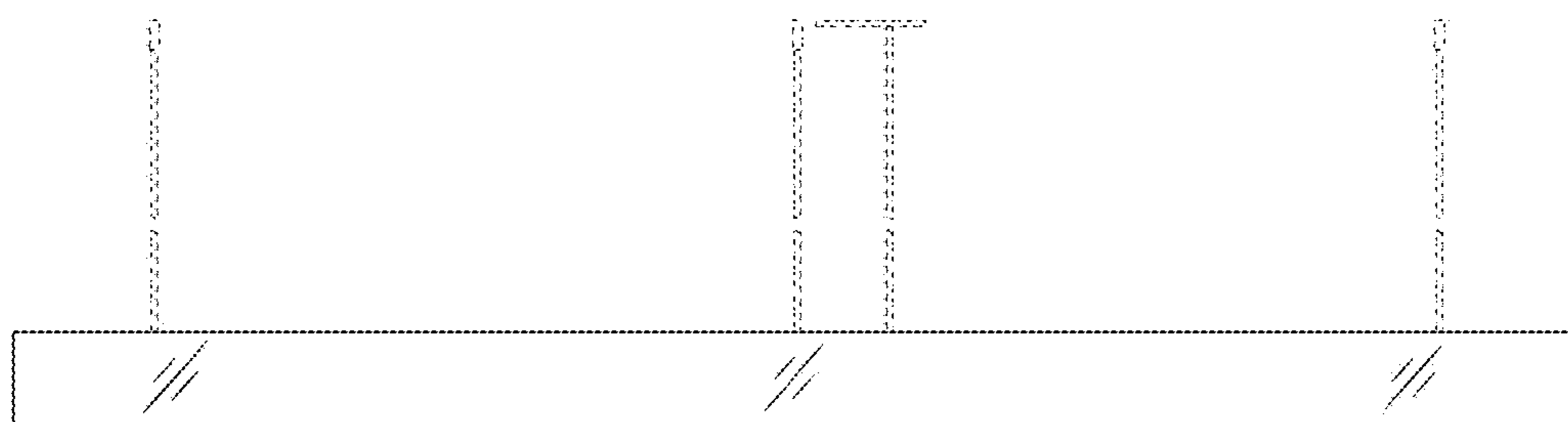

FIG. 115

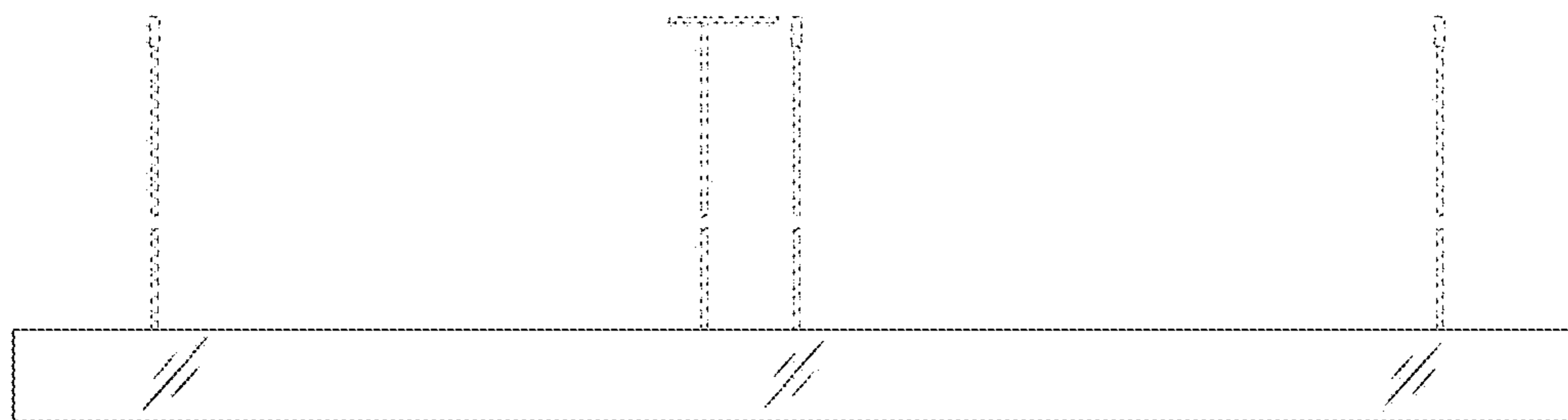

FIG. 116

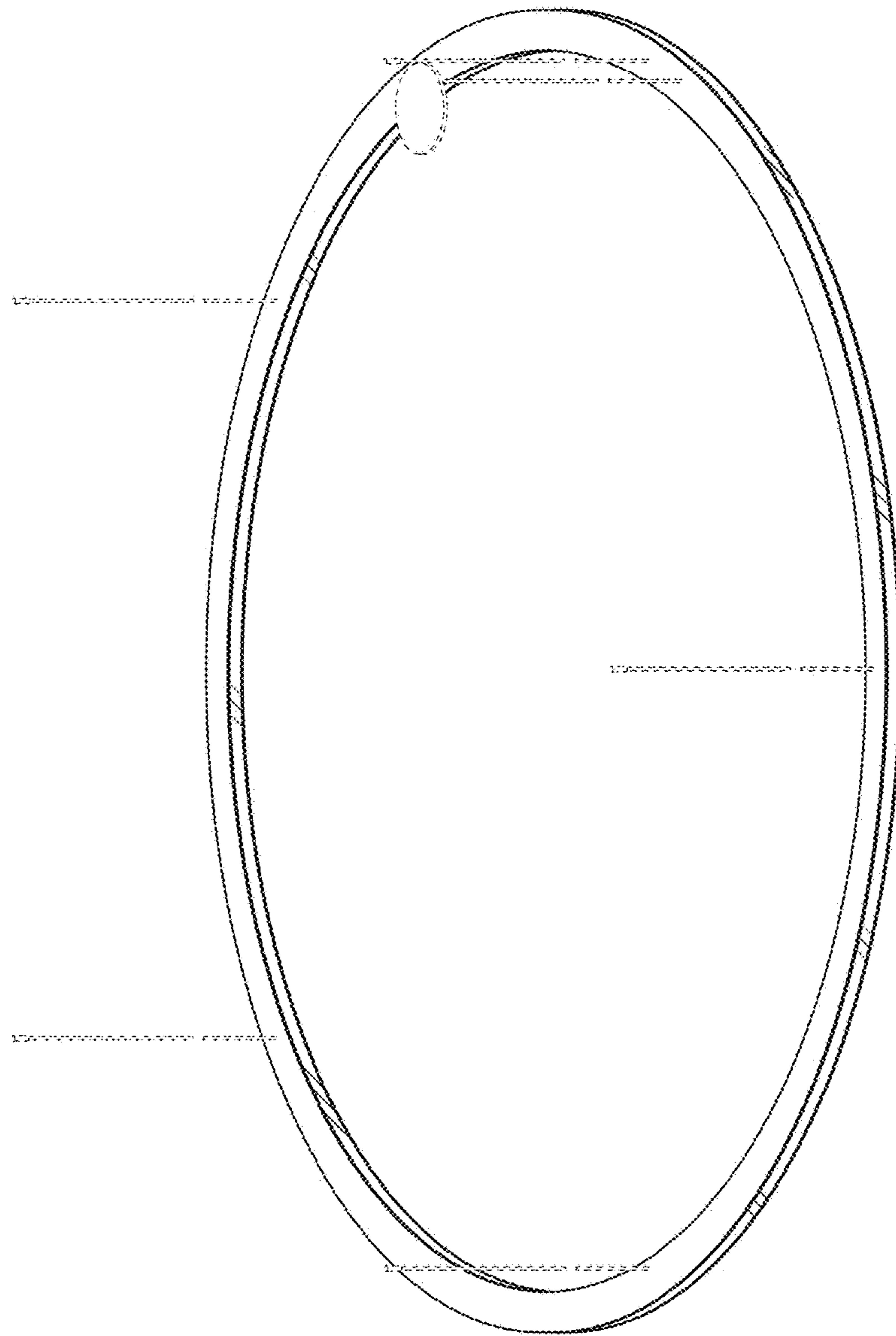

FIG. 117

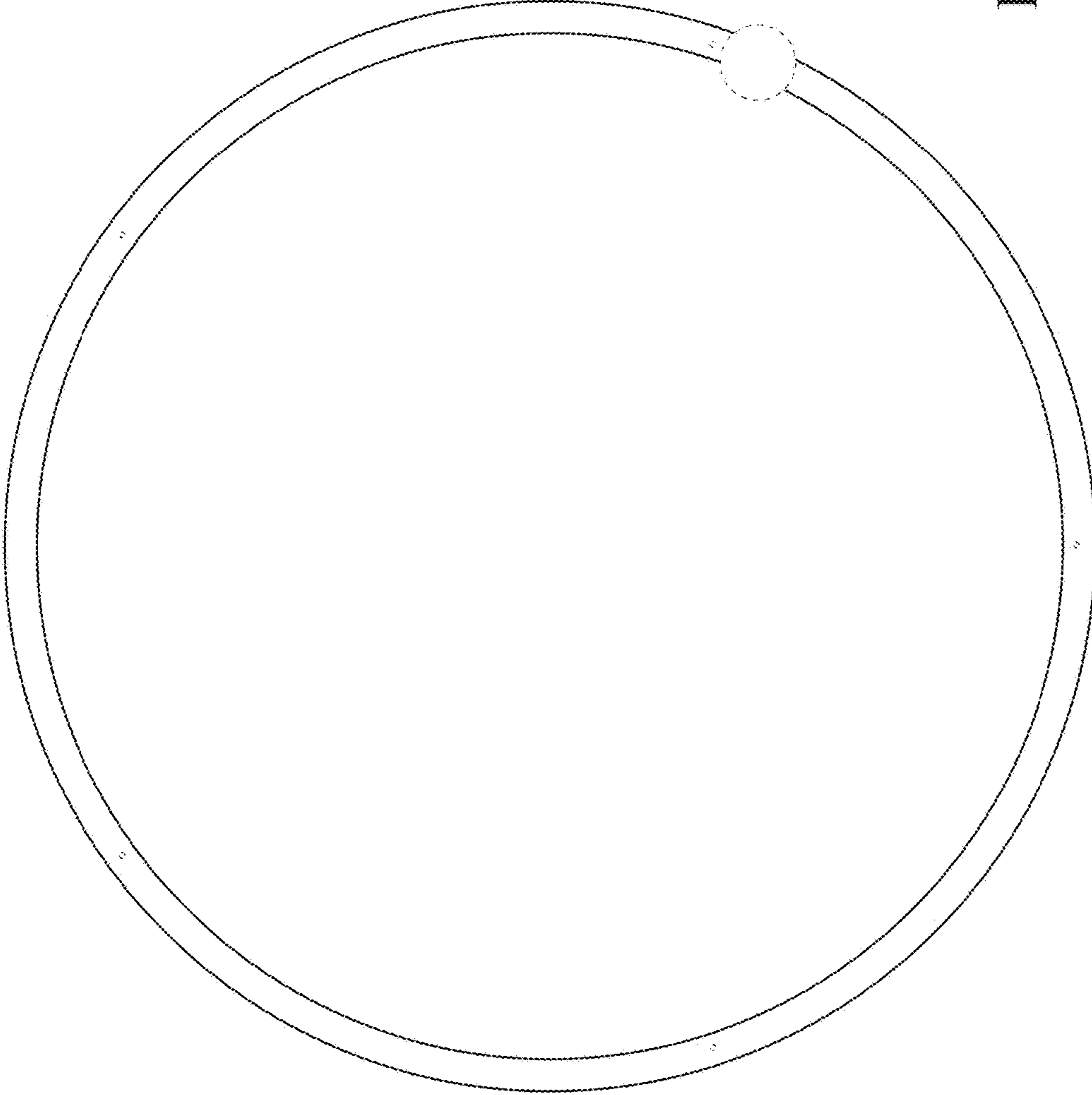

FIG. 118

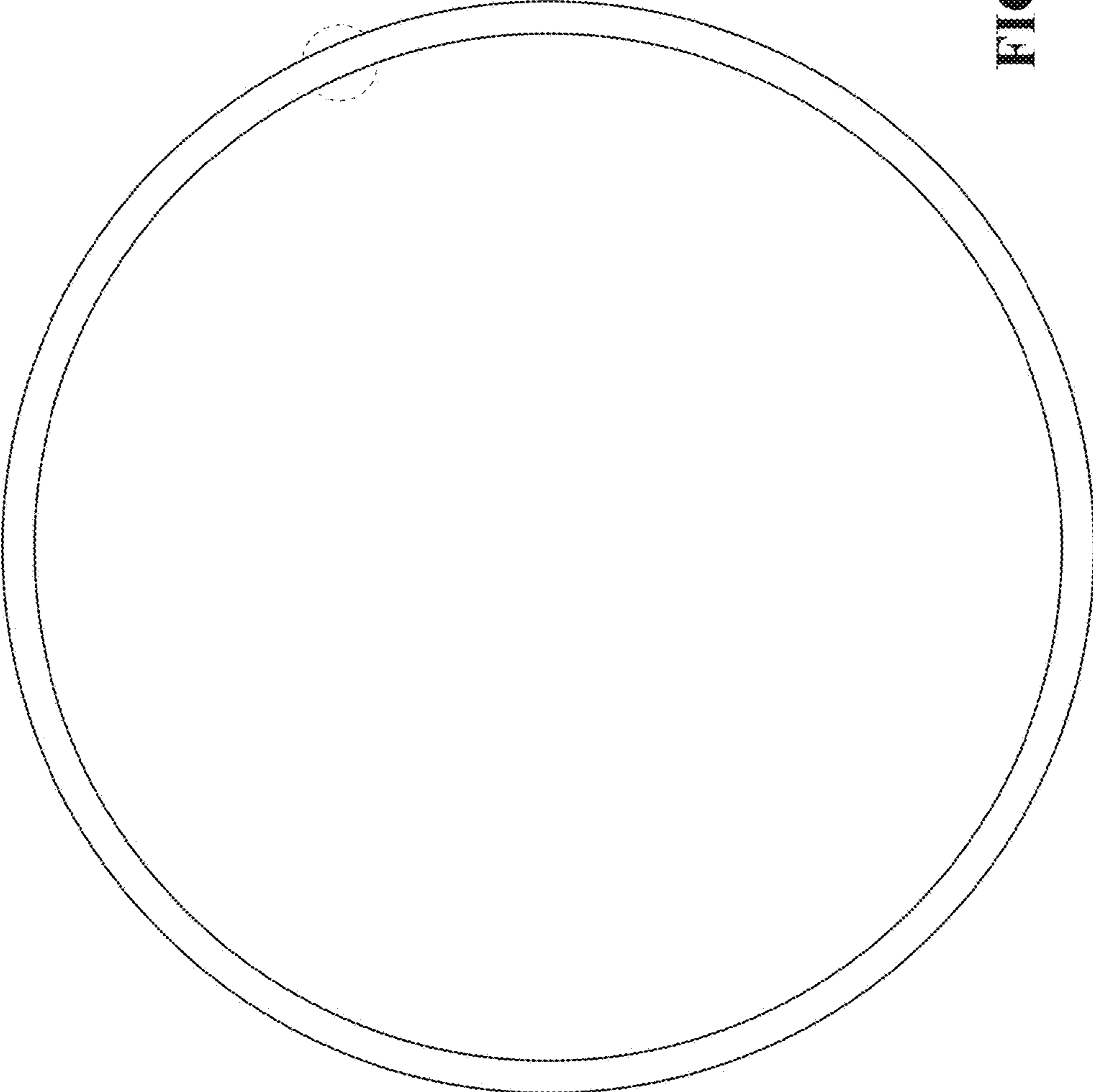

FIG. 119

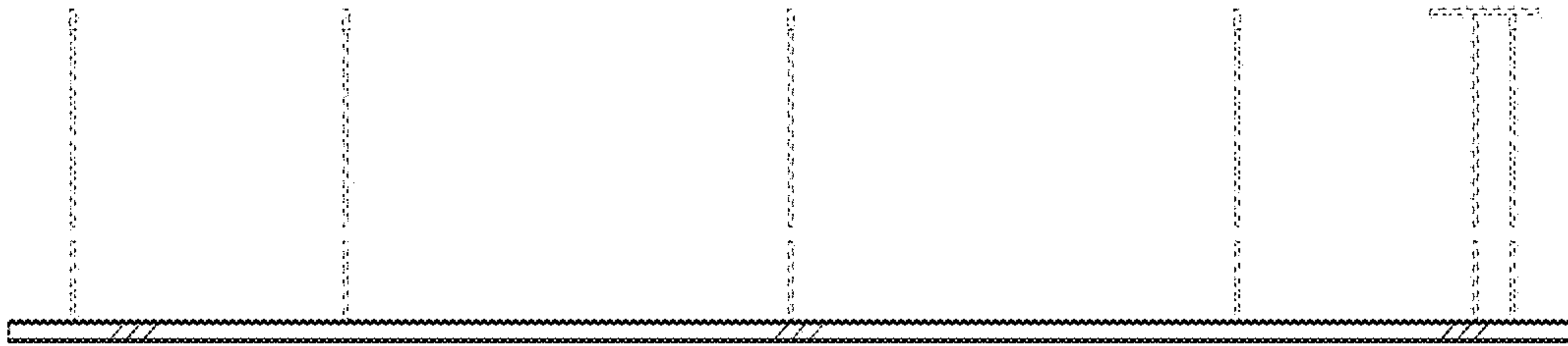

FIG. 120

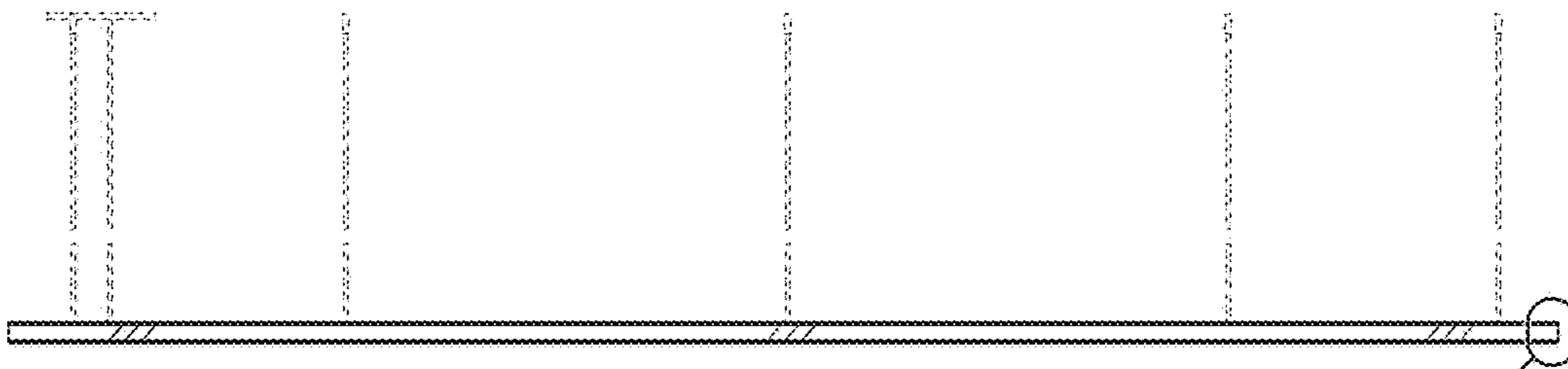

FIG. 121

FIG. 122



FIG. 122

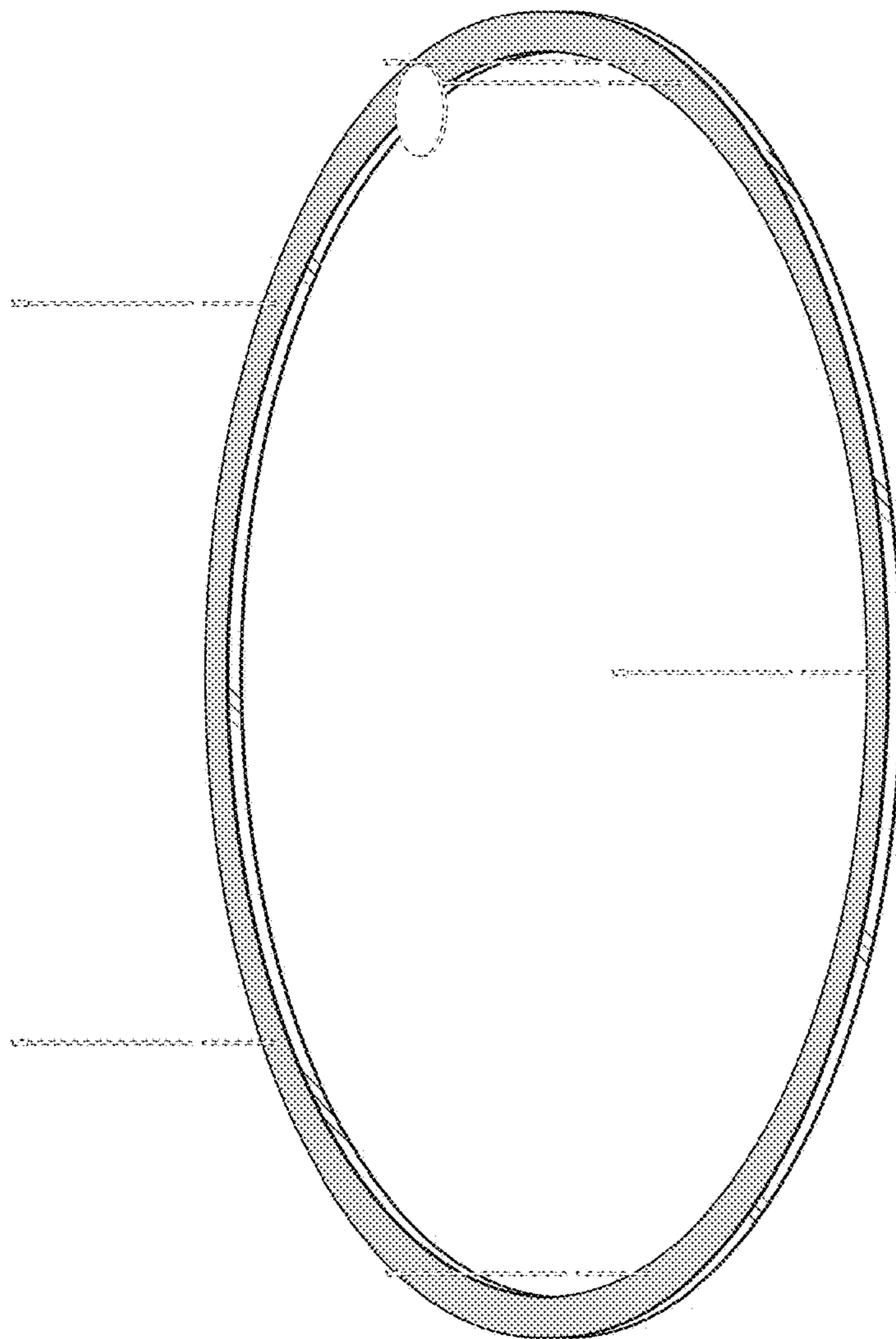

FIG. 123

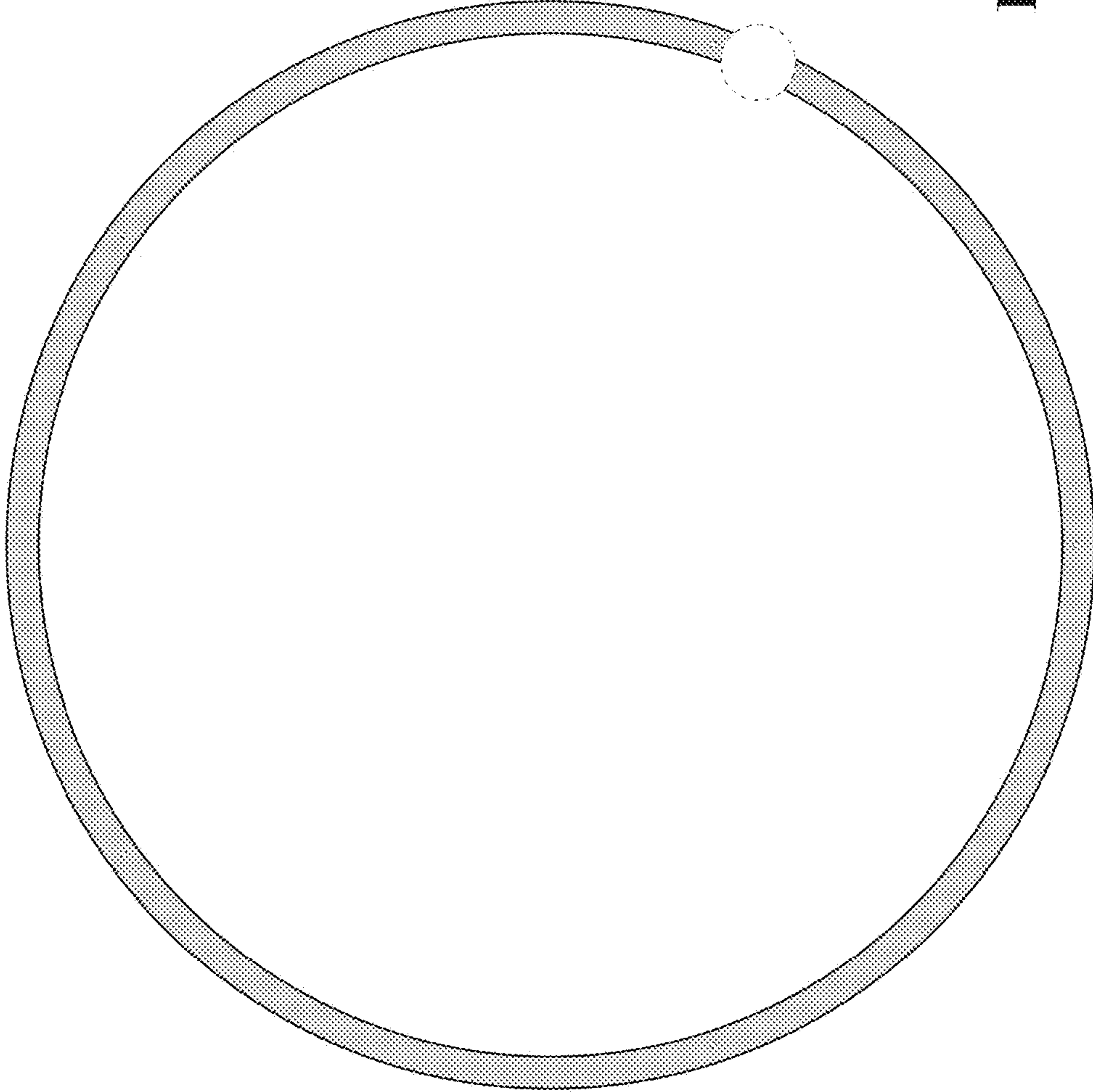

FIG. 124

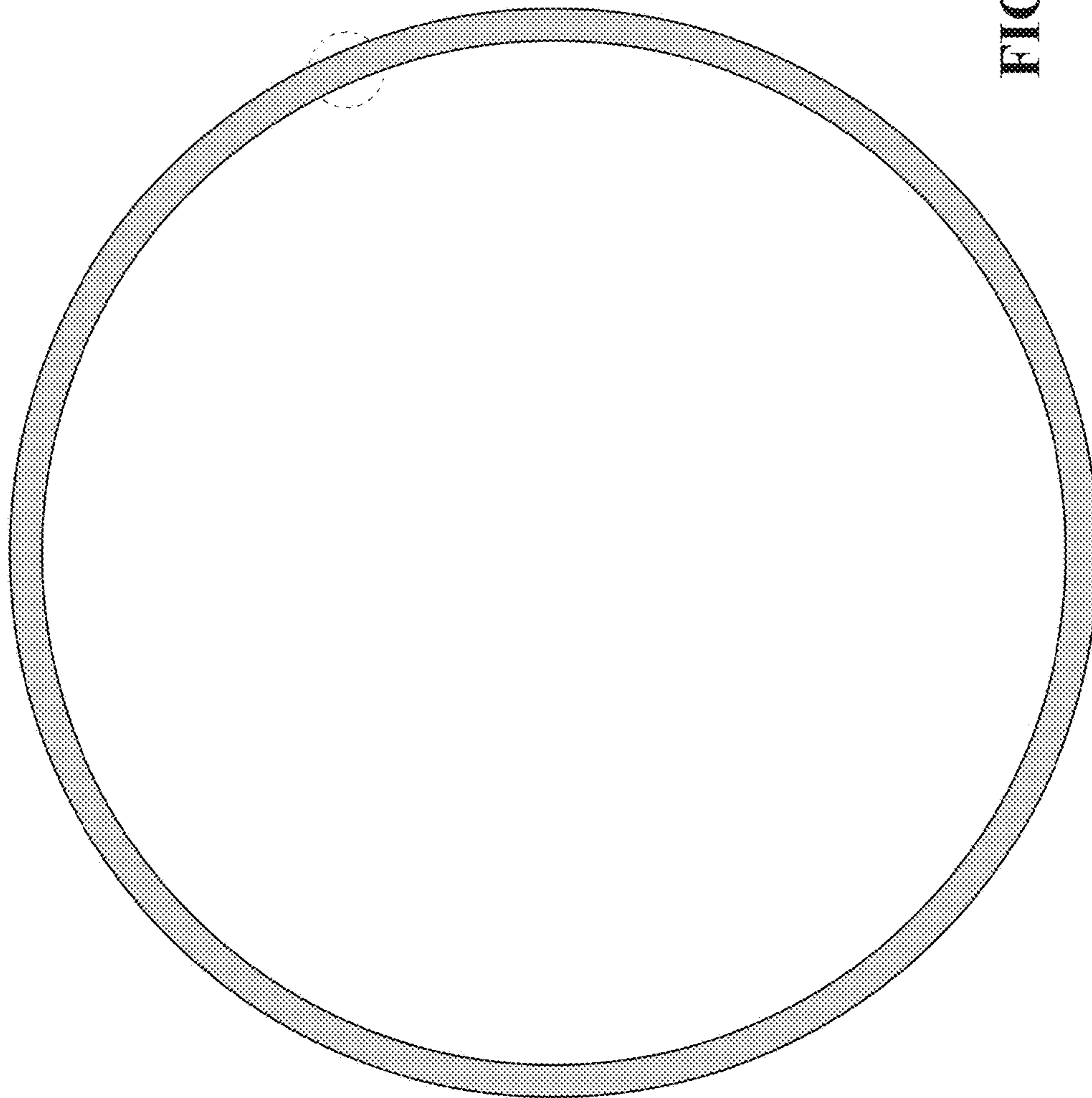

FIG. 125

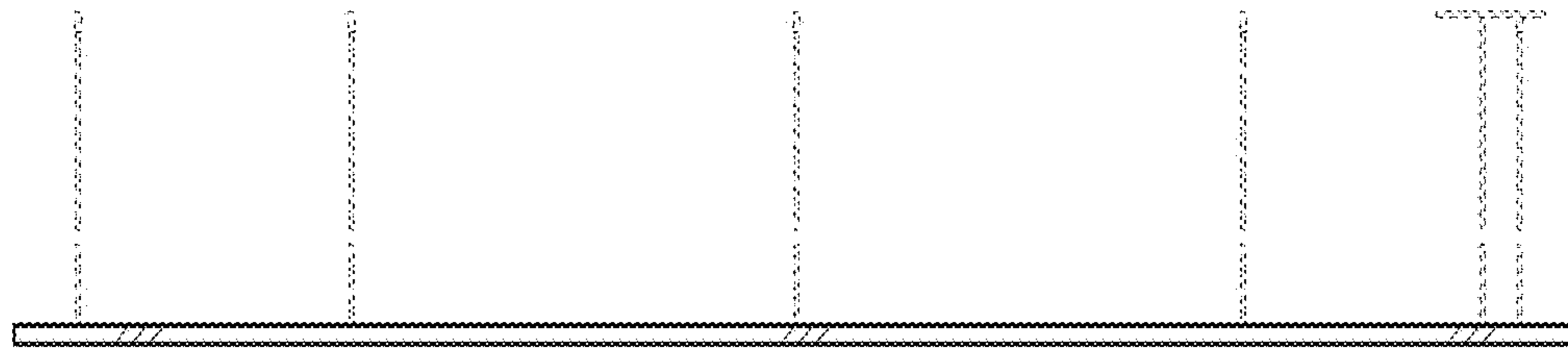

FIG. 126

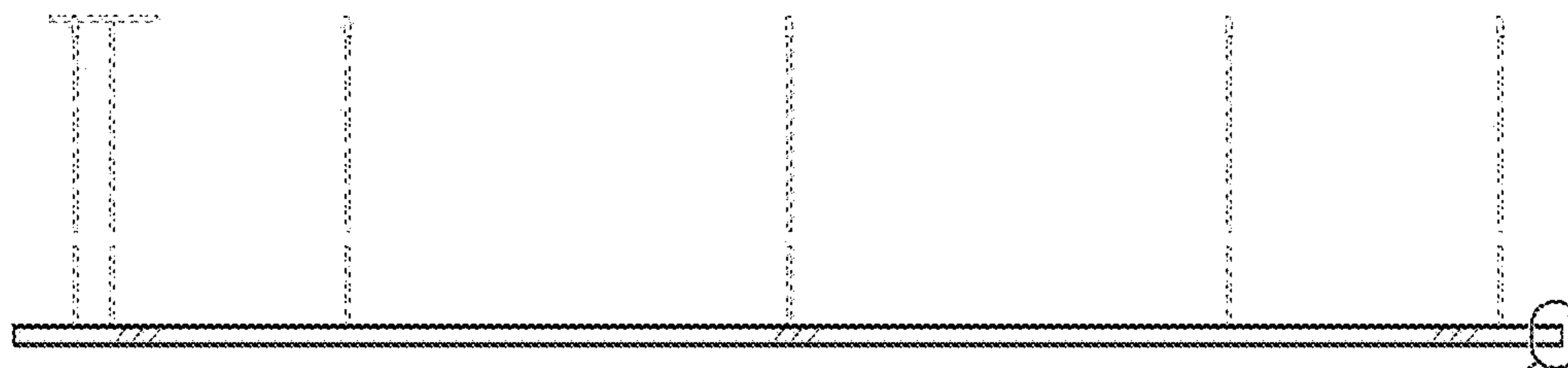

FIG. 127

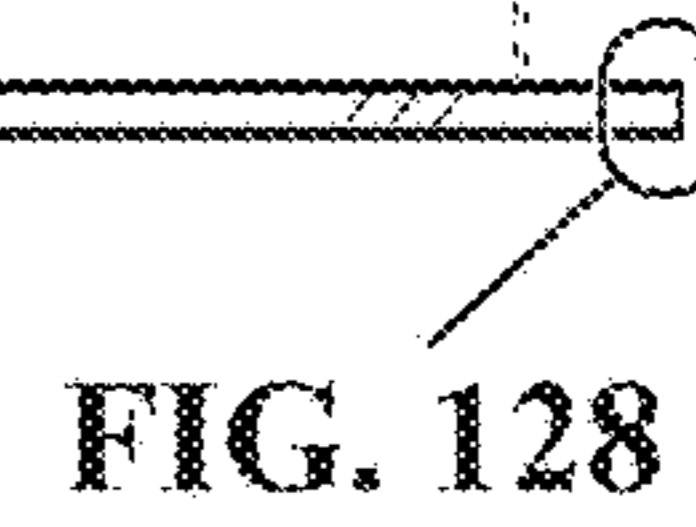

FIG. 128

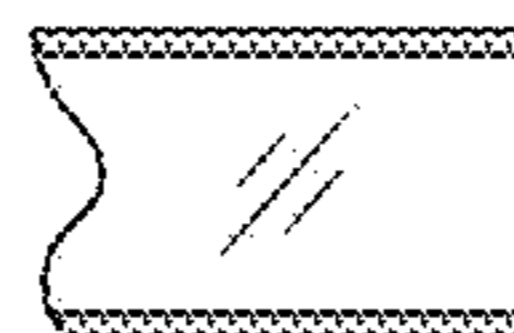

FIG. 128

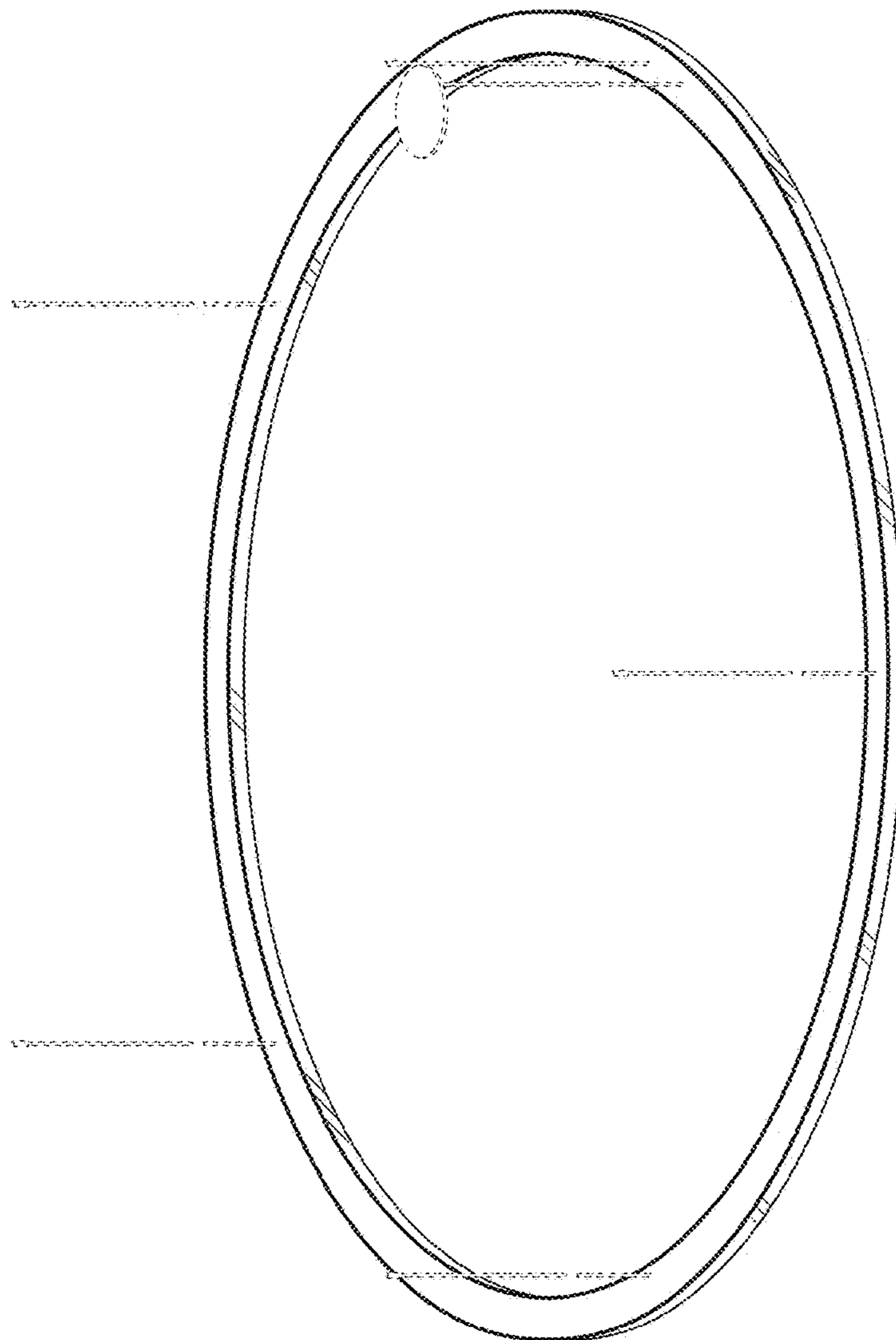
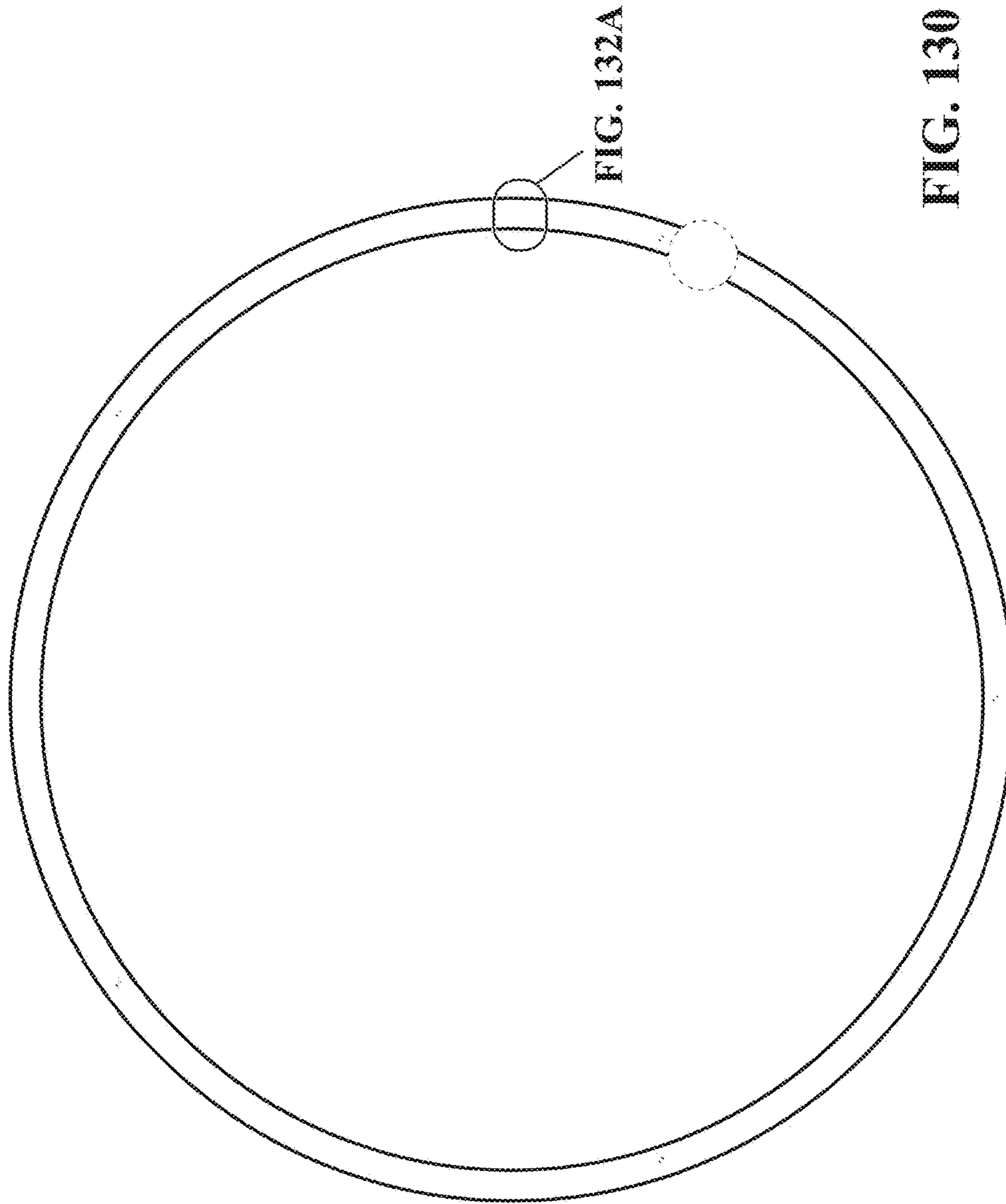

FIG. 129



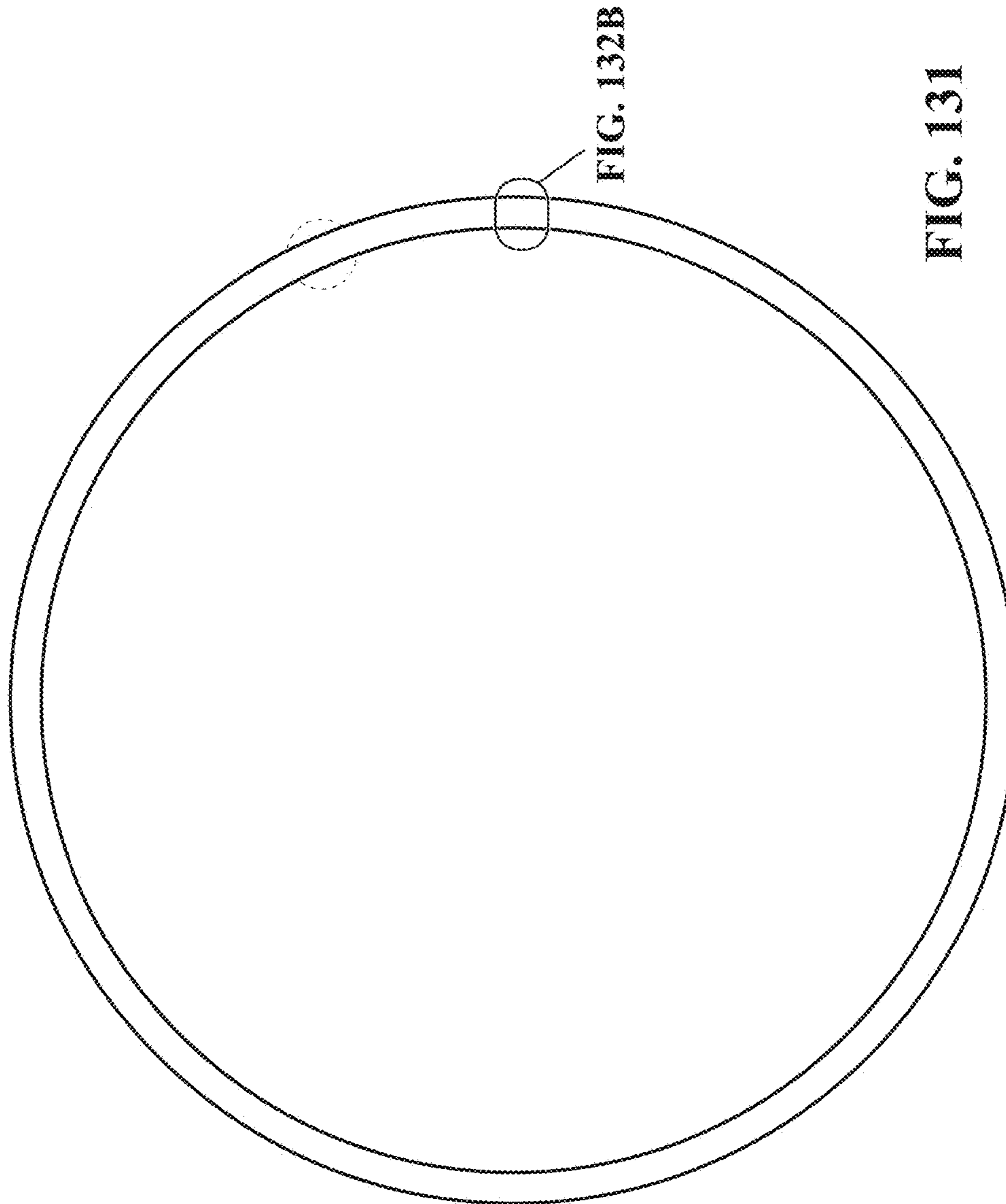

FIG. 132B



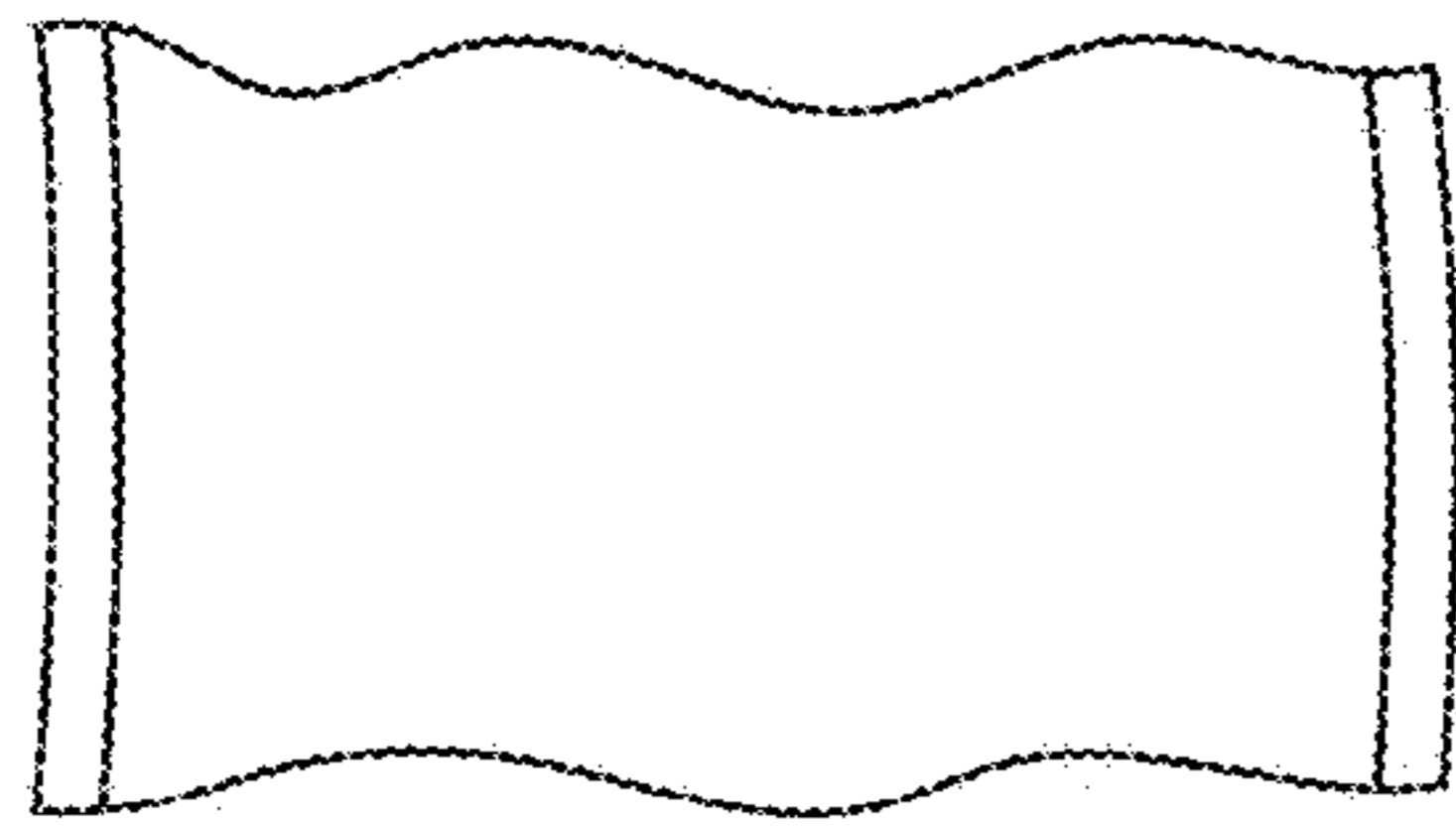

FIG. 132A

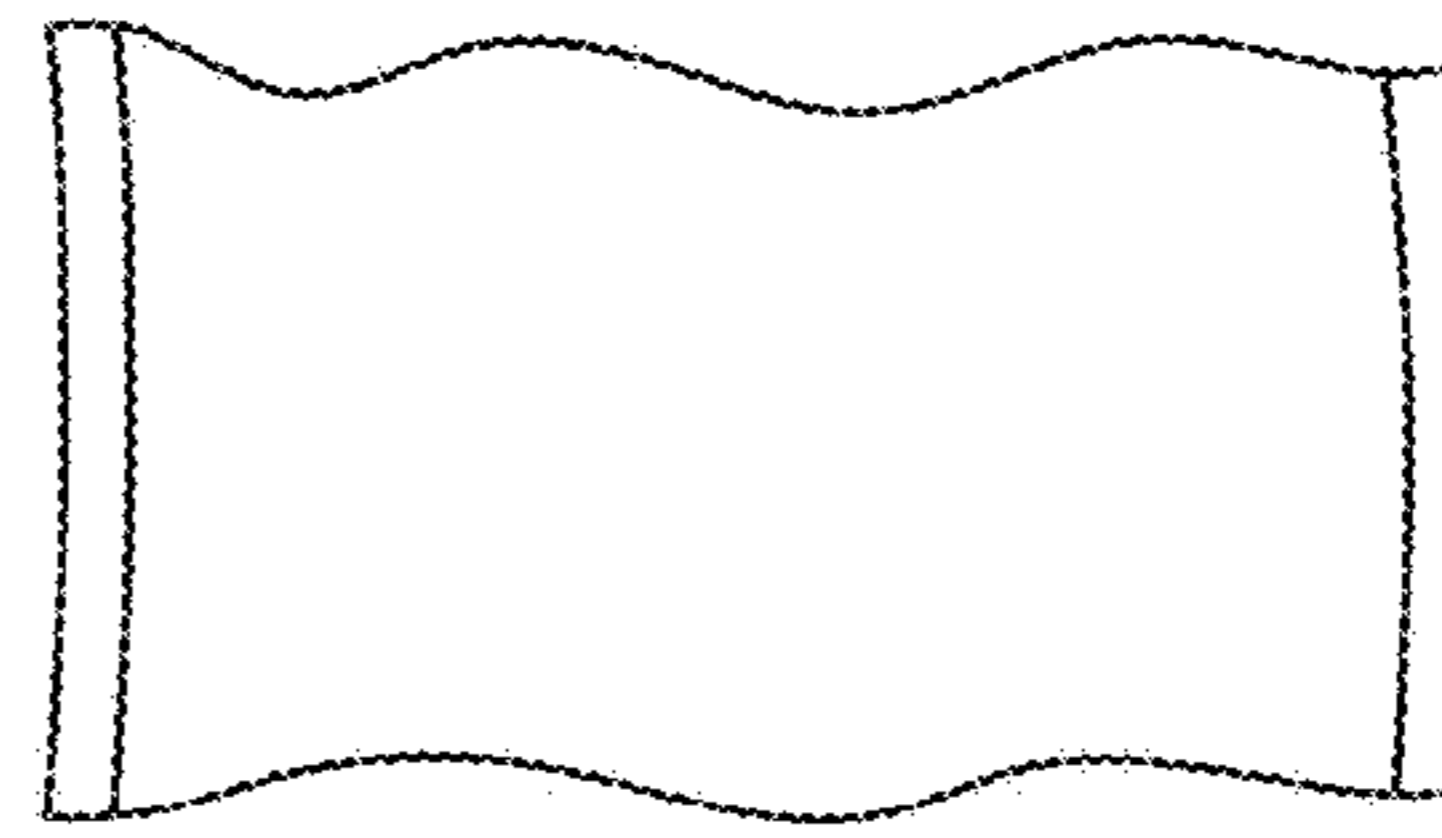

FIG. 132B

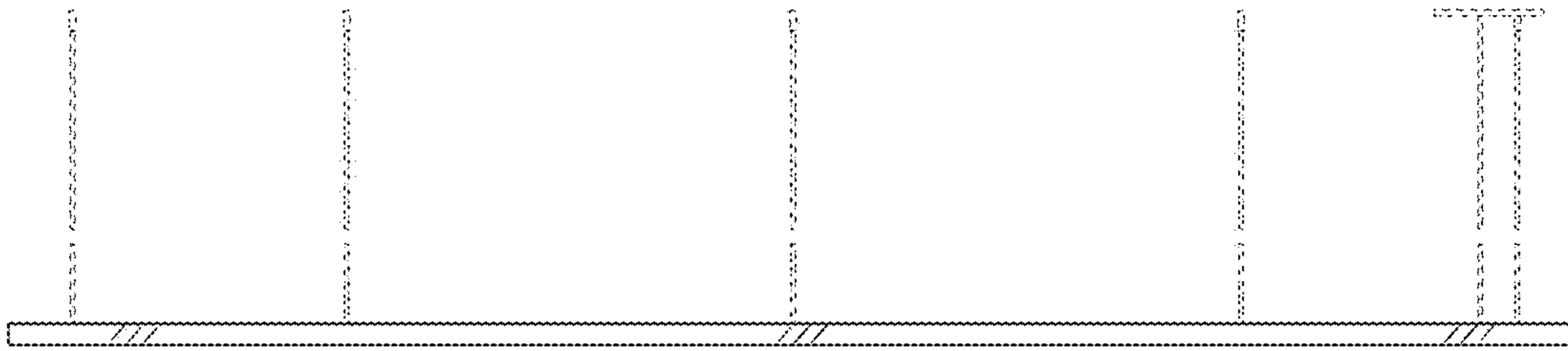

FIG. 133

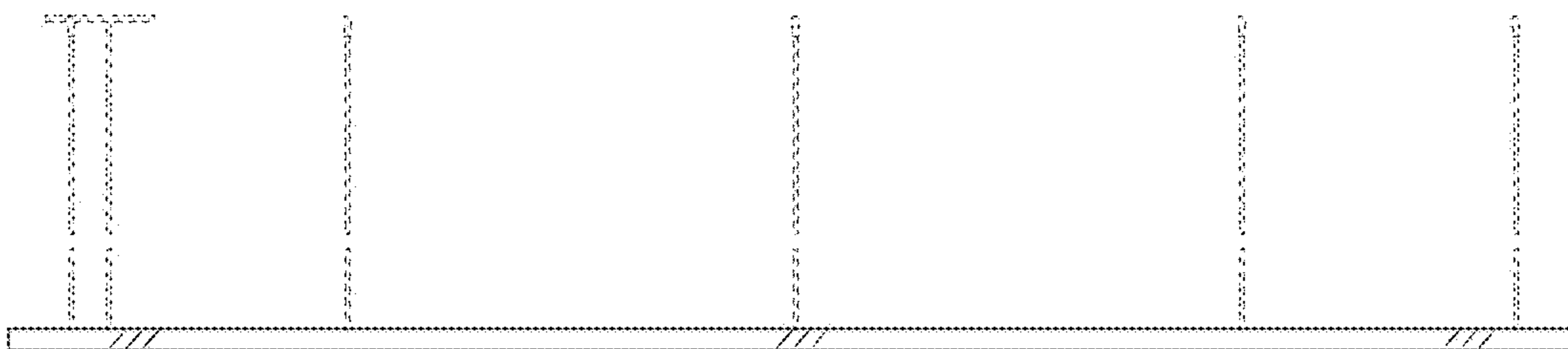

FIG. 134

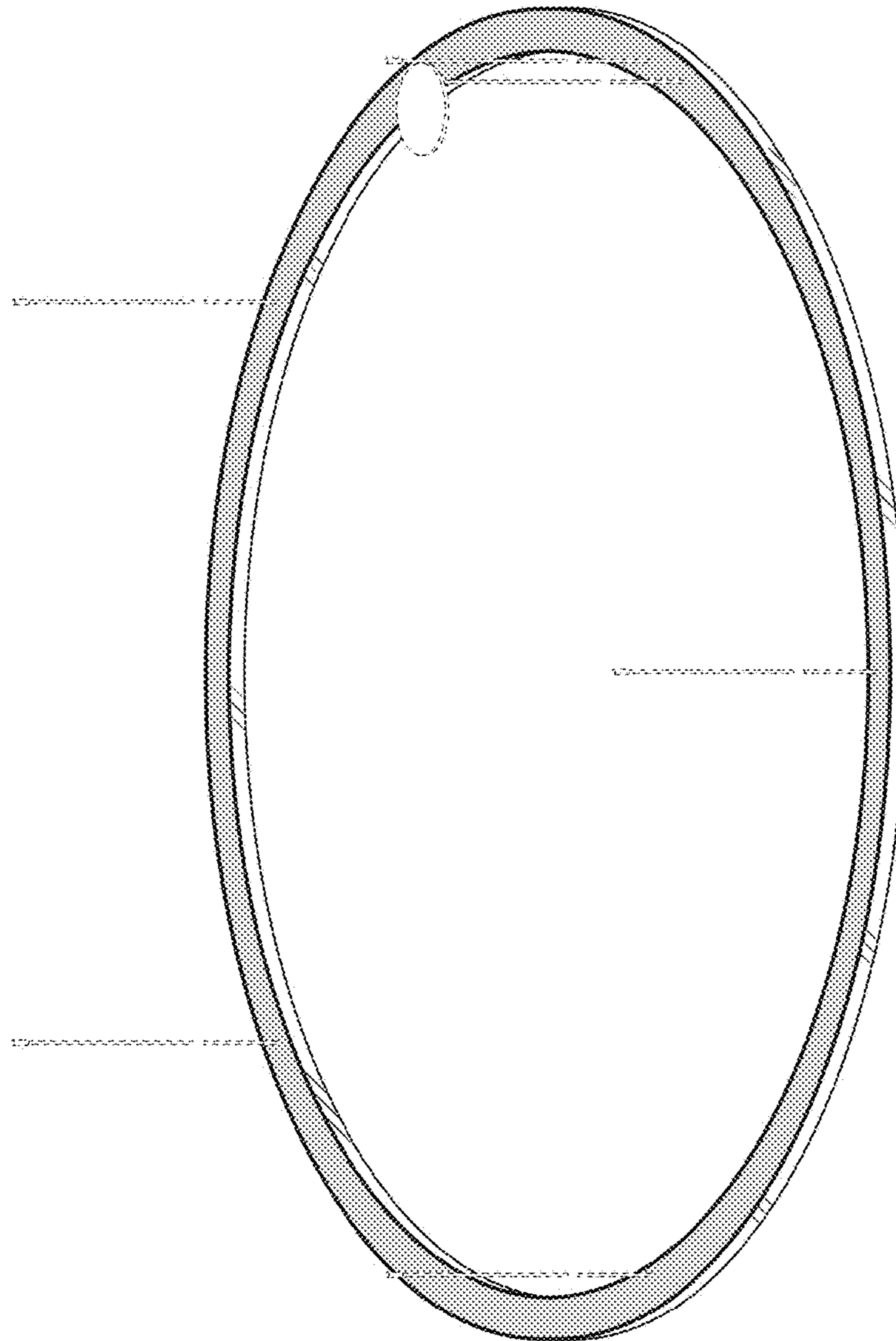

FIG. 135

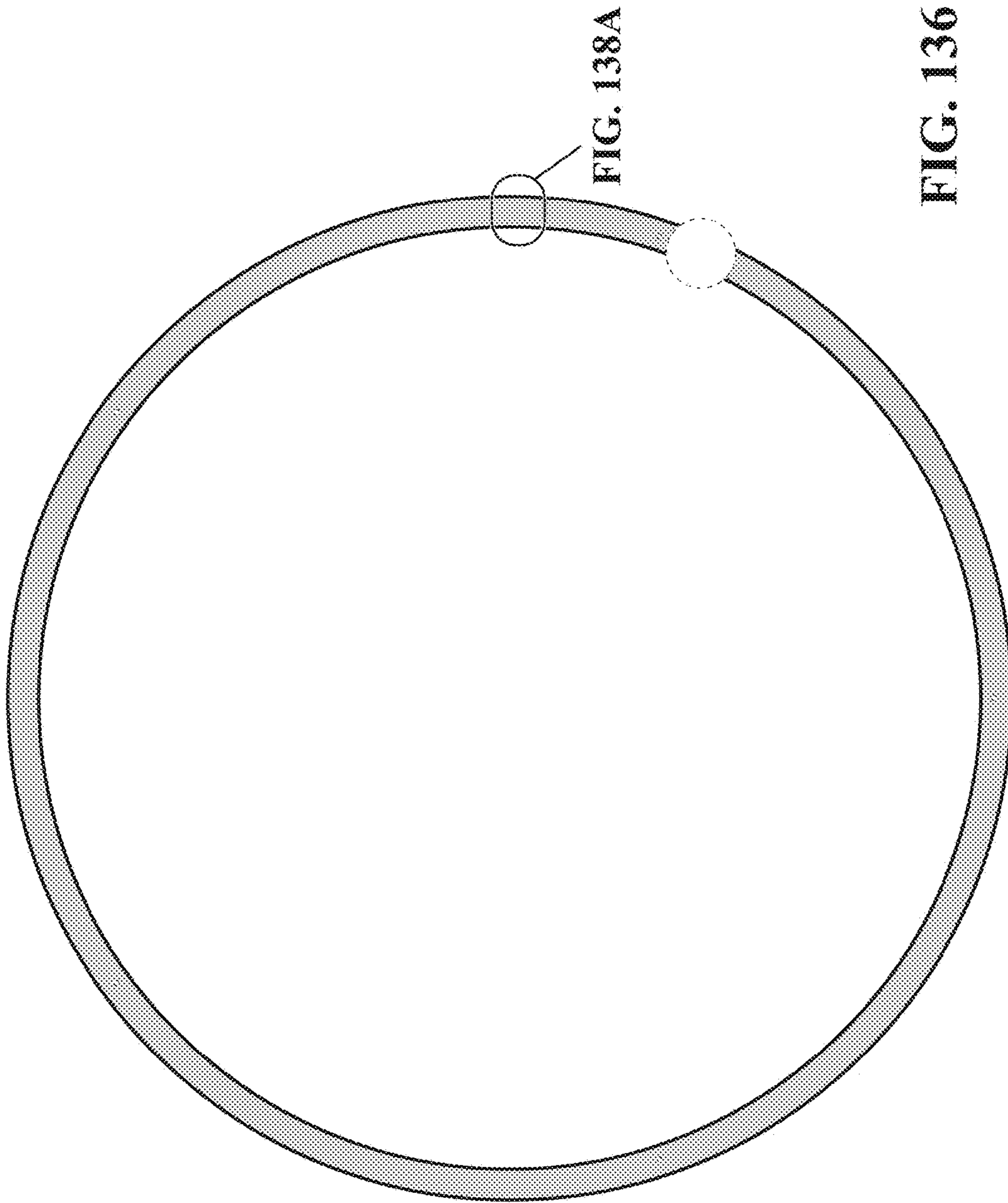

FIG. 138A

FIG. 136

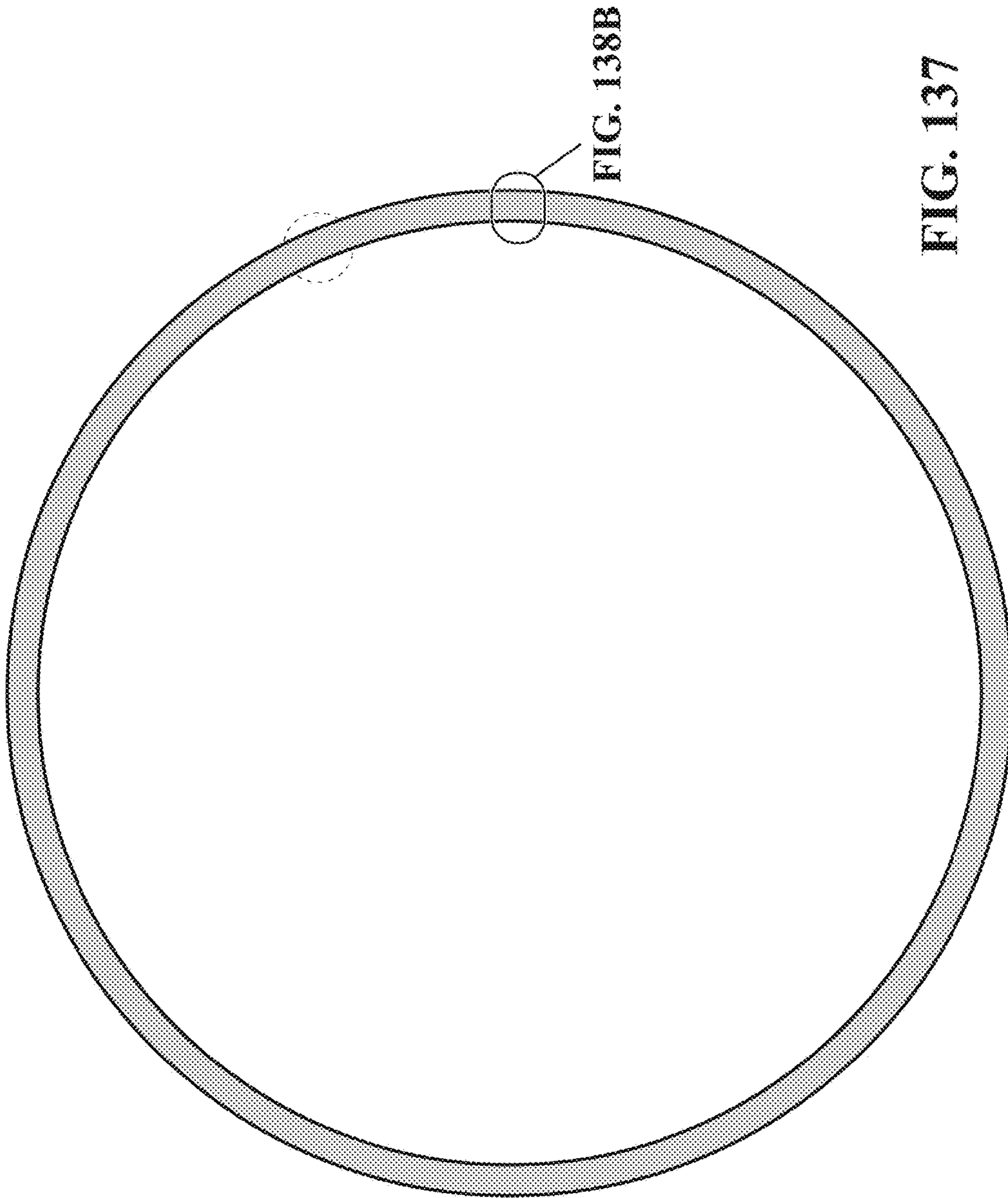

FIG. 138B

FIG. 137

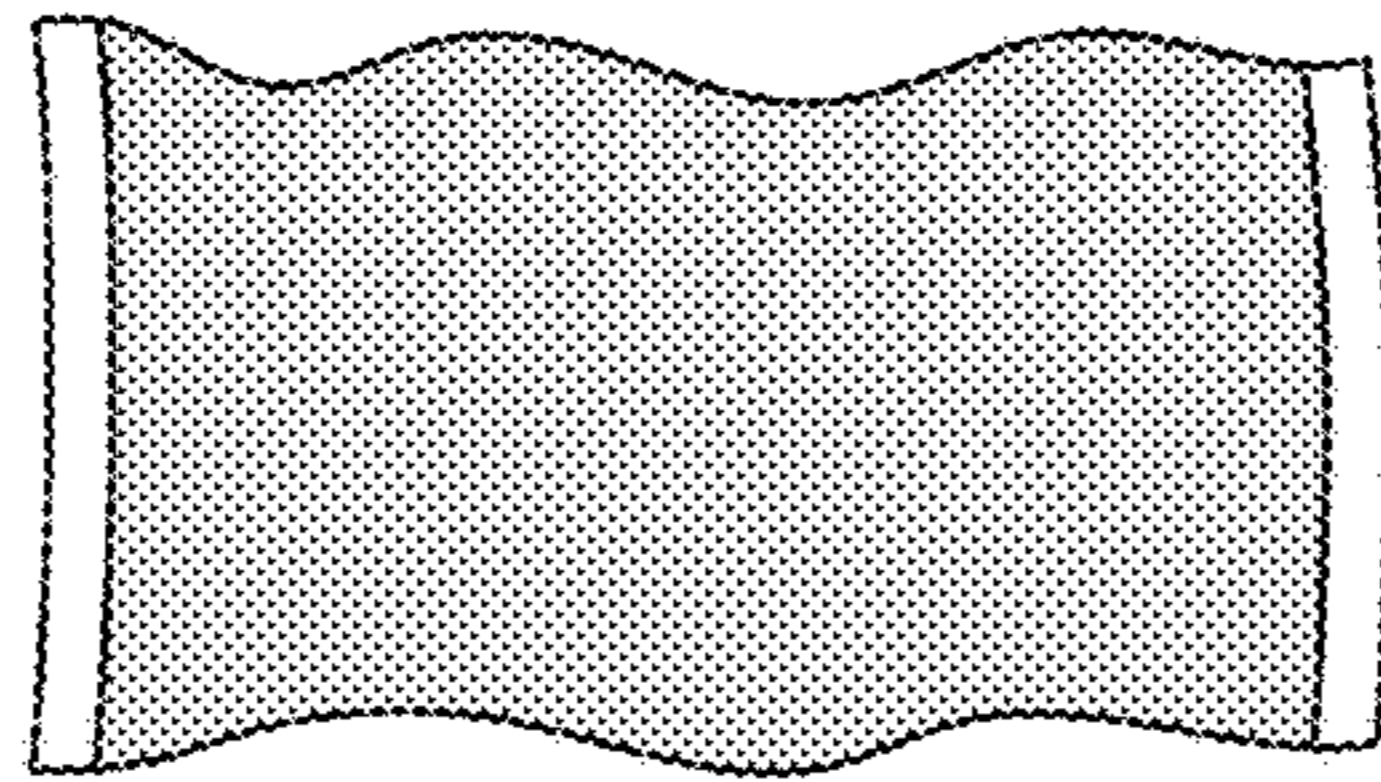

FIG. 138A

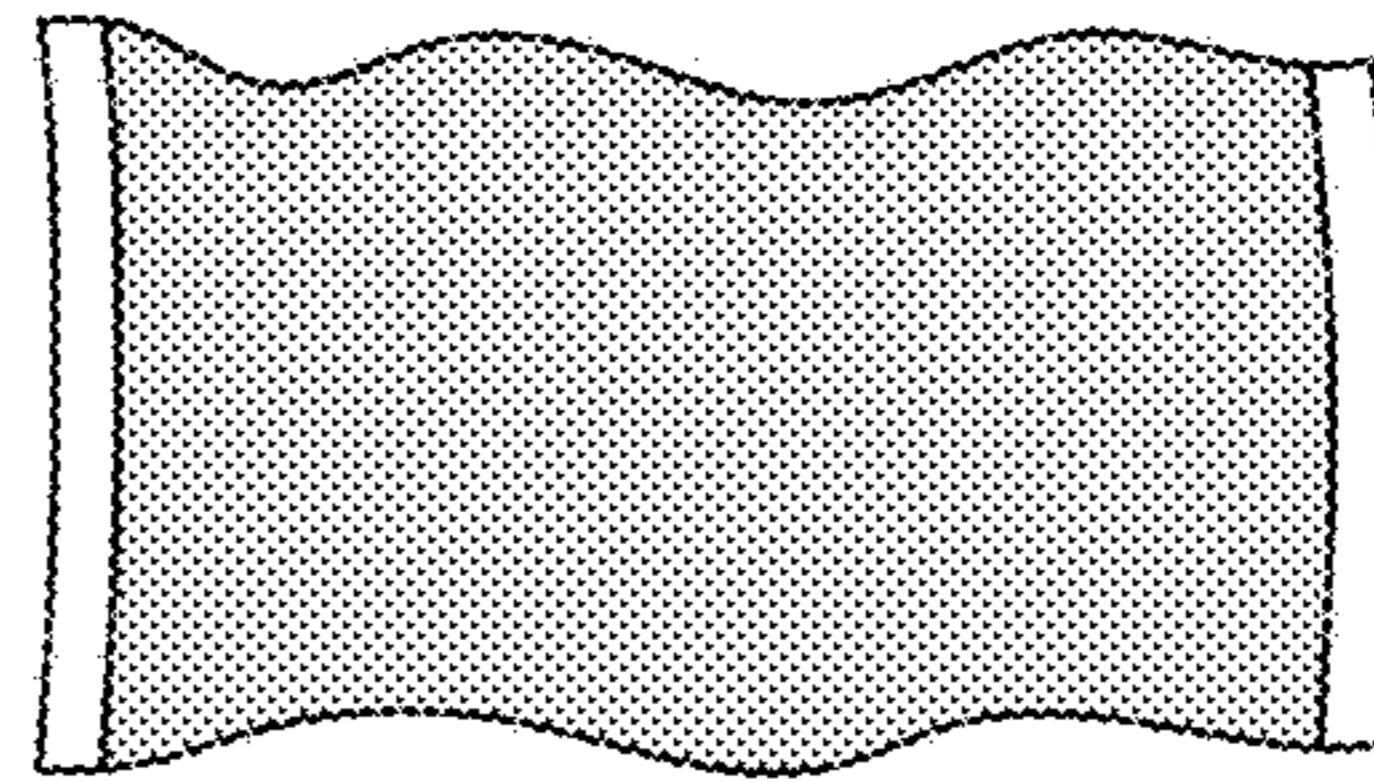

FIG. 138B

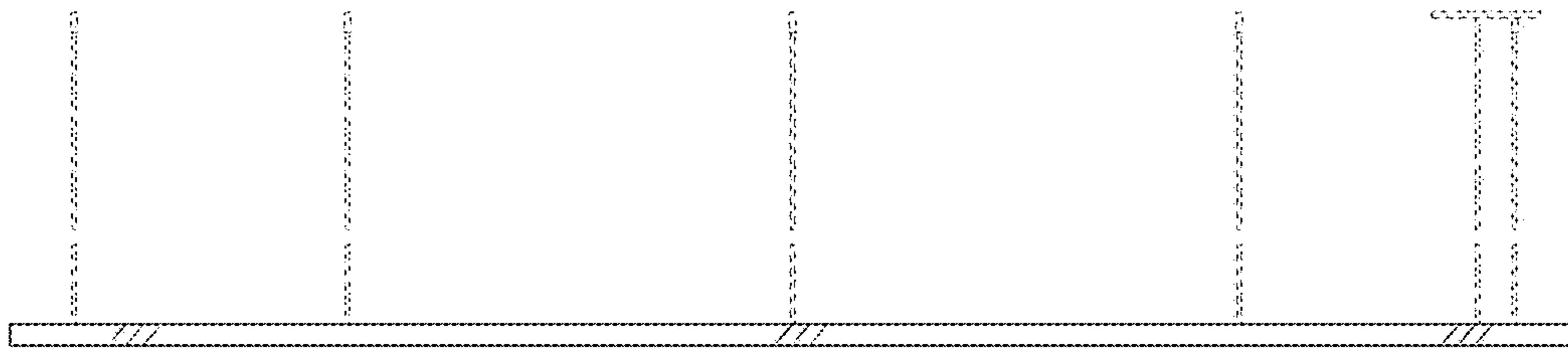

FIG. 139

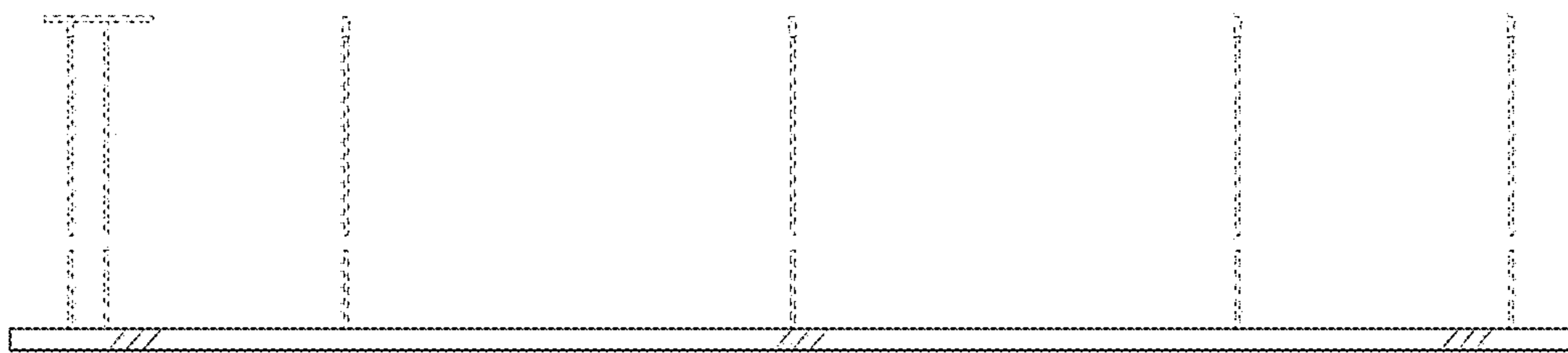

FIG. 140

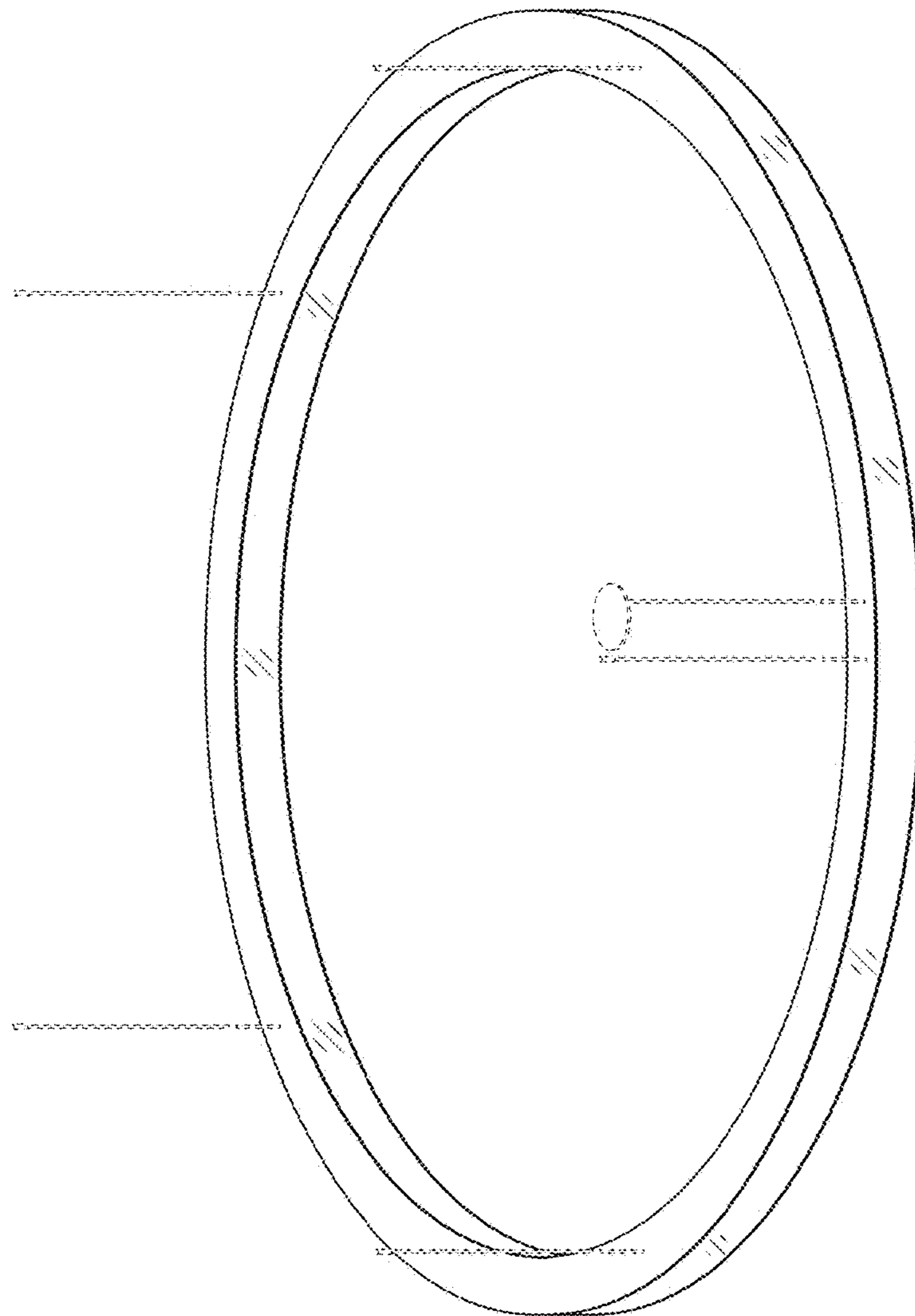

FIG. 141

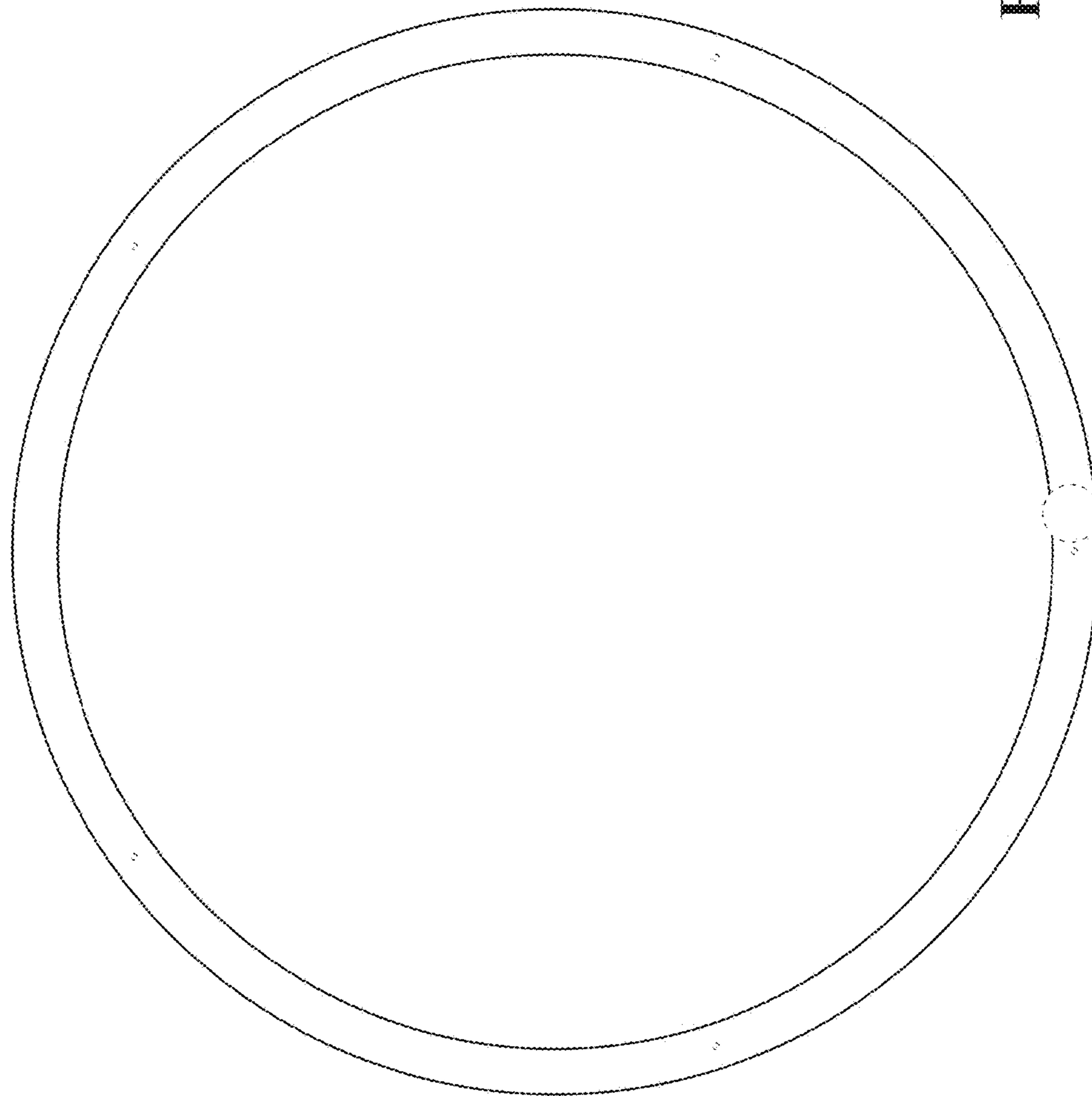

FIG. 142

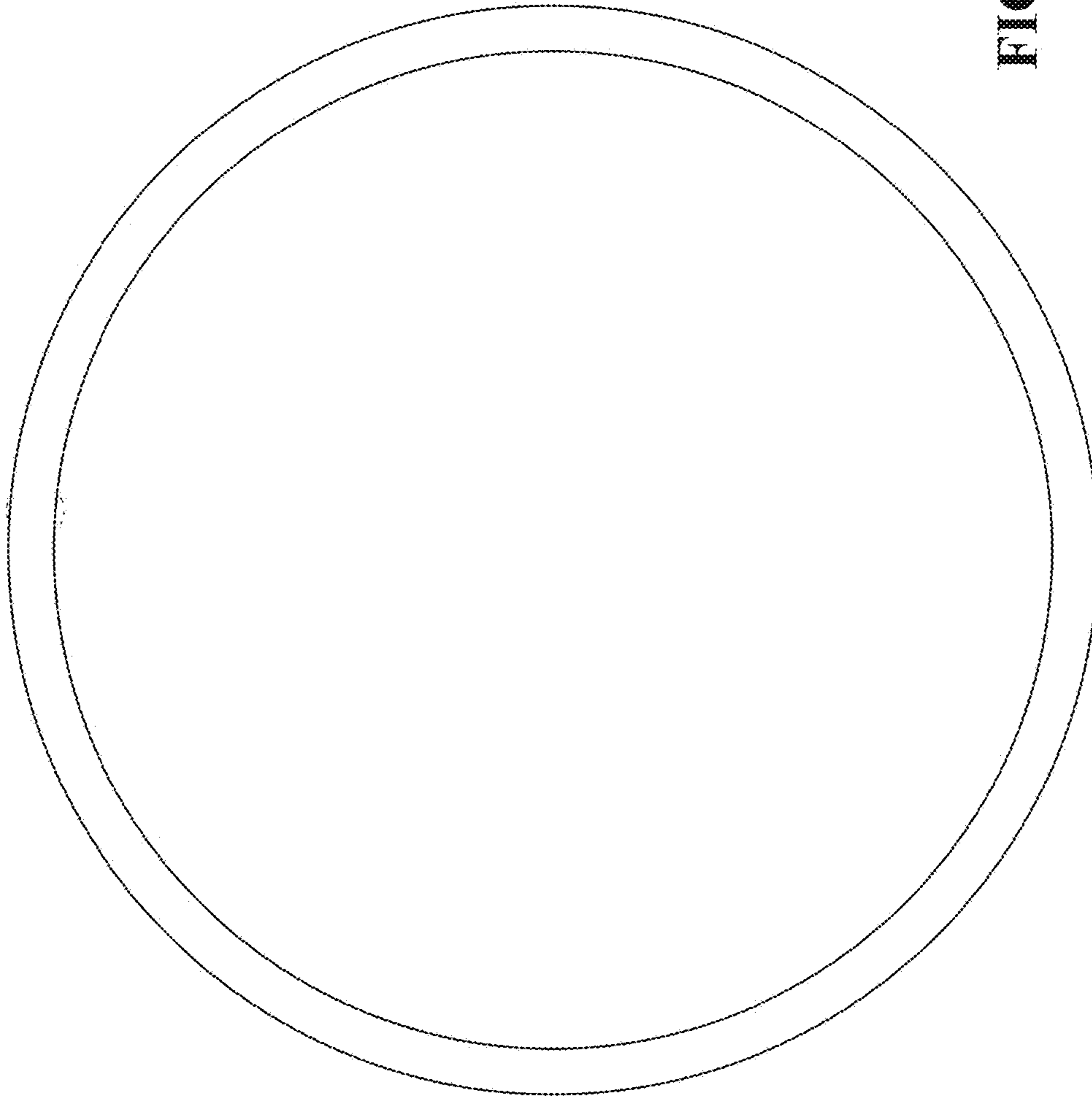

FIG. 143

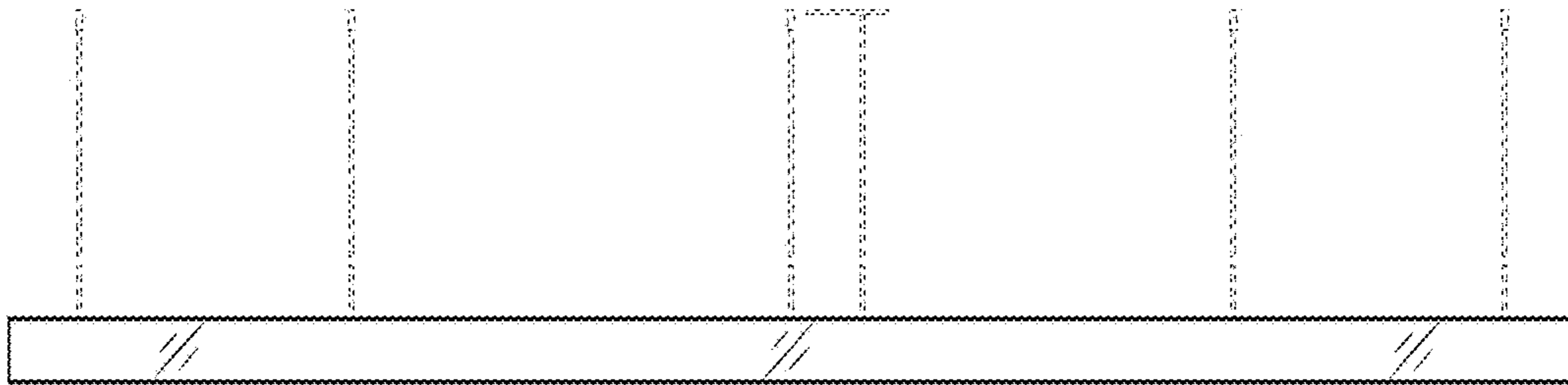

FIG. 144

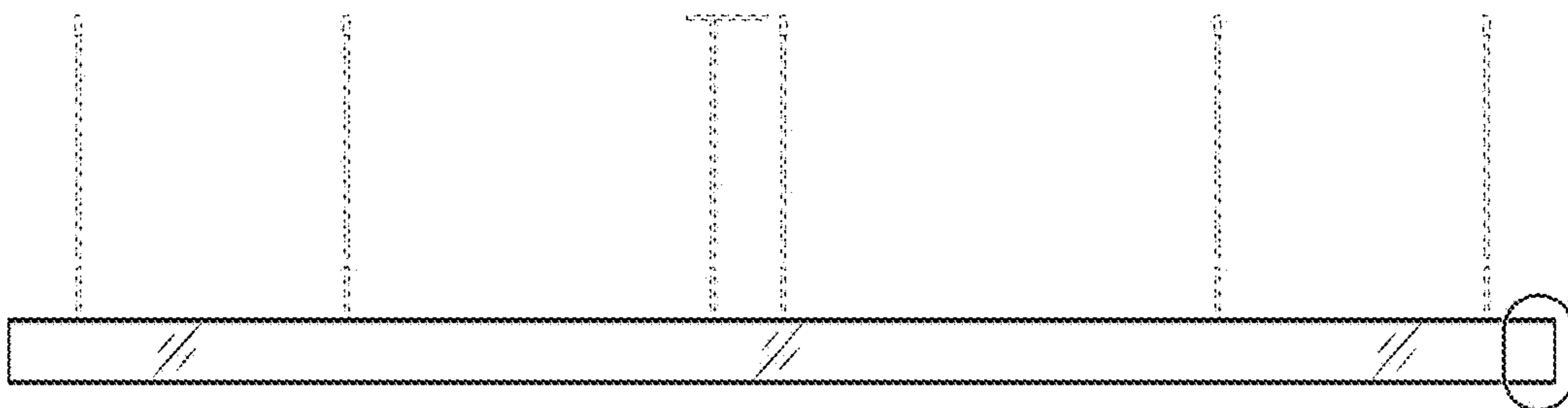

FIG. 145

FIG. 146



FIG. 146

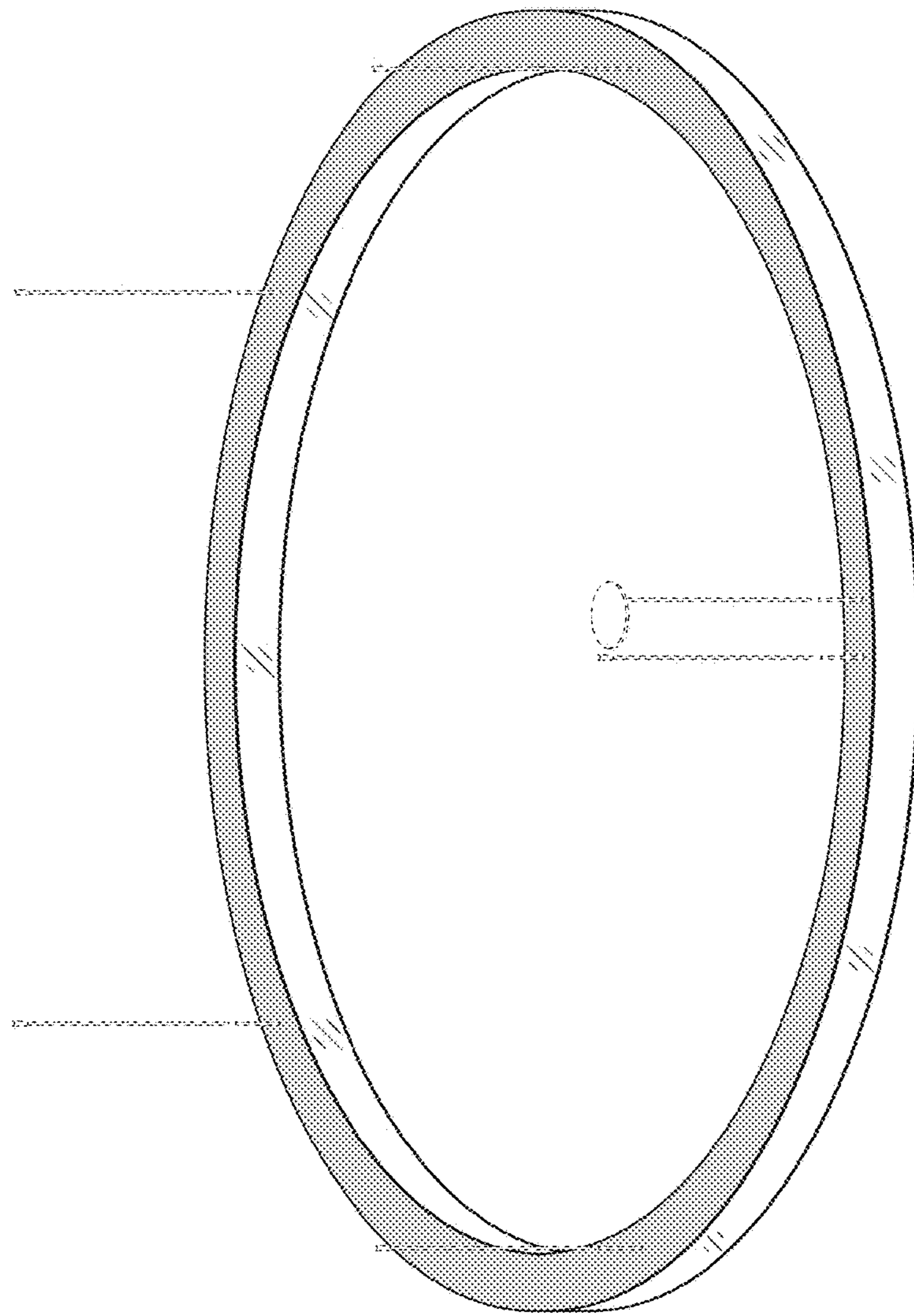

FIG. 147

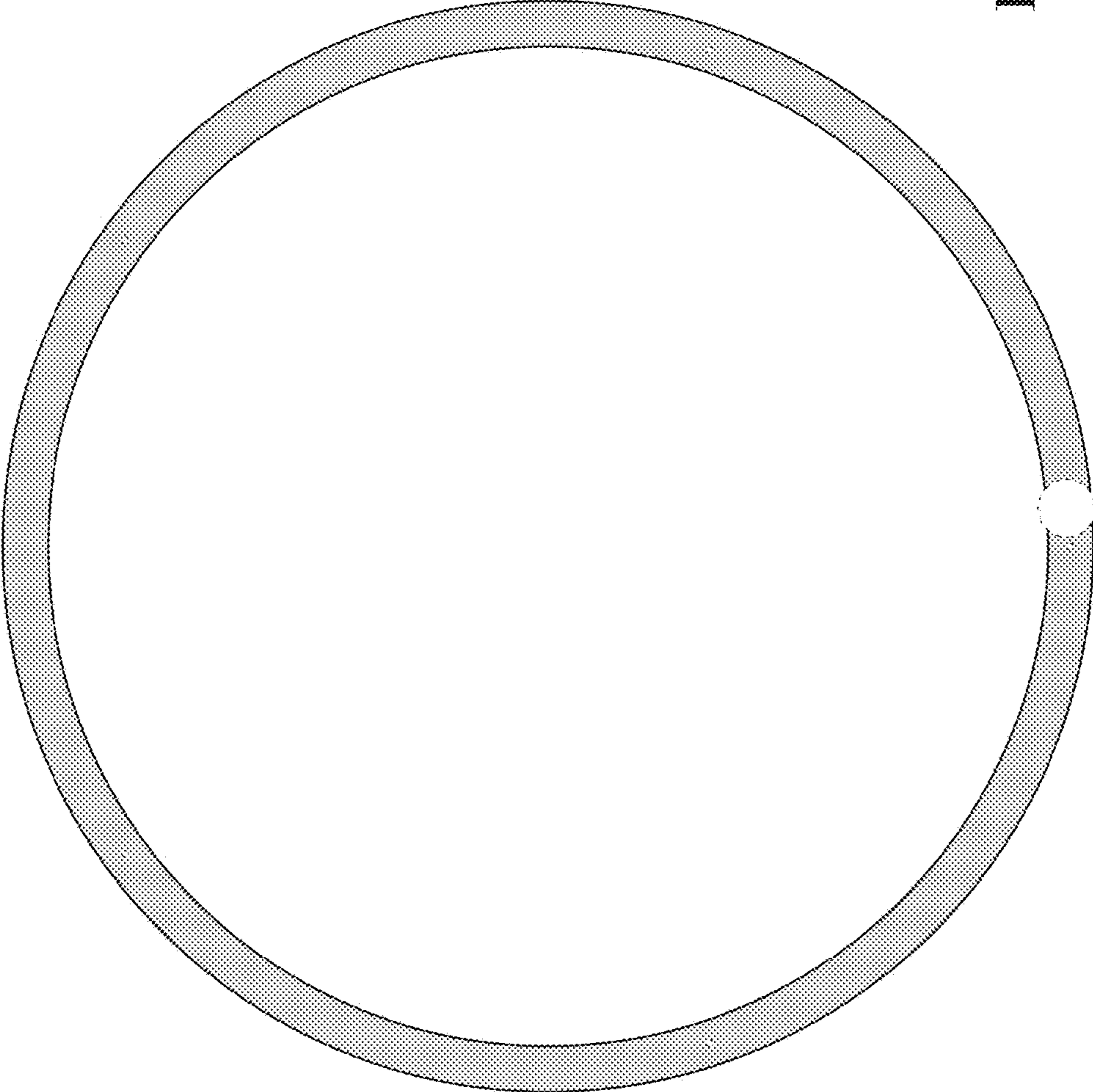

FIG. 148

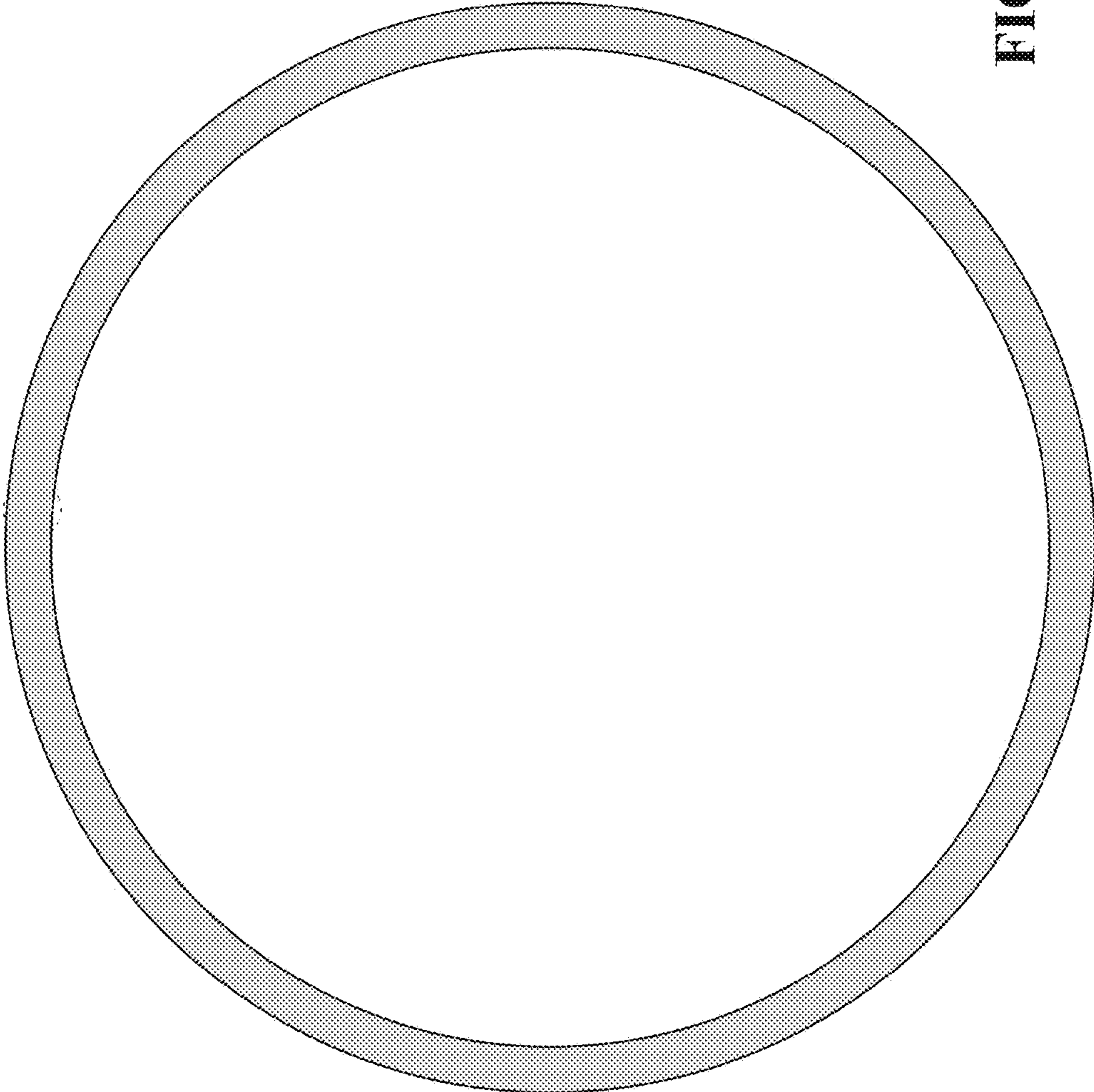

FIG. 149

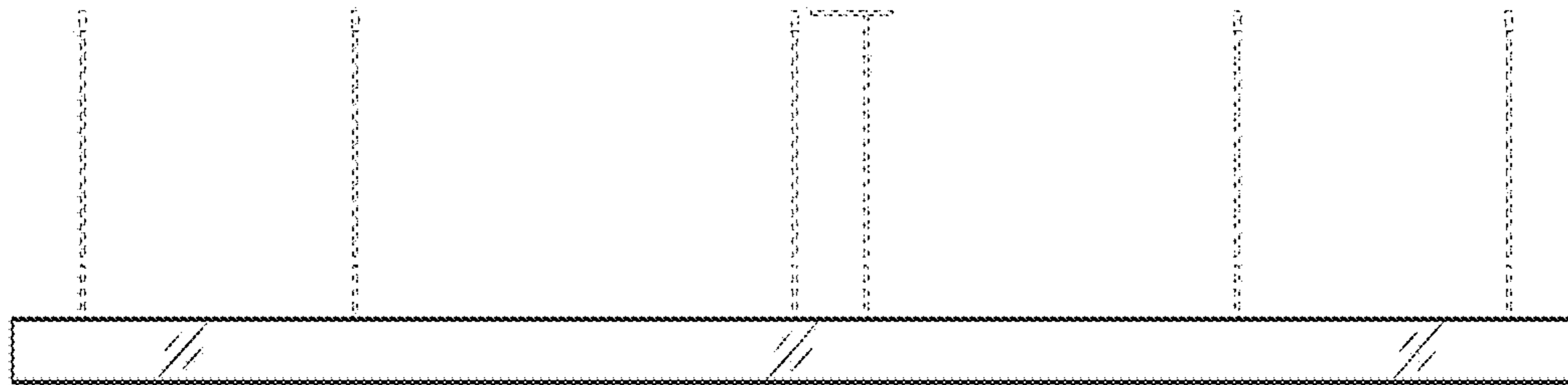

FIG. 150

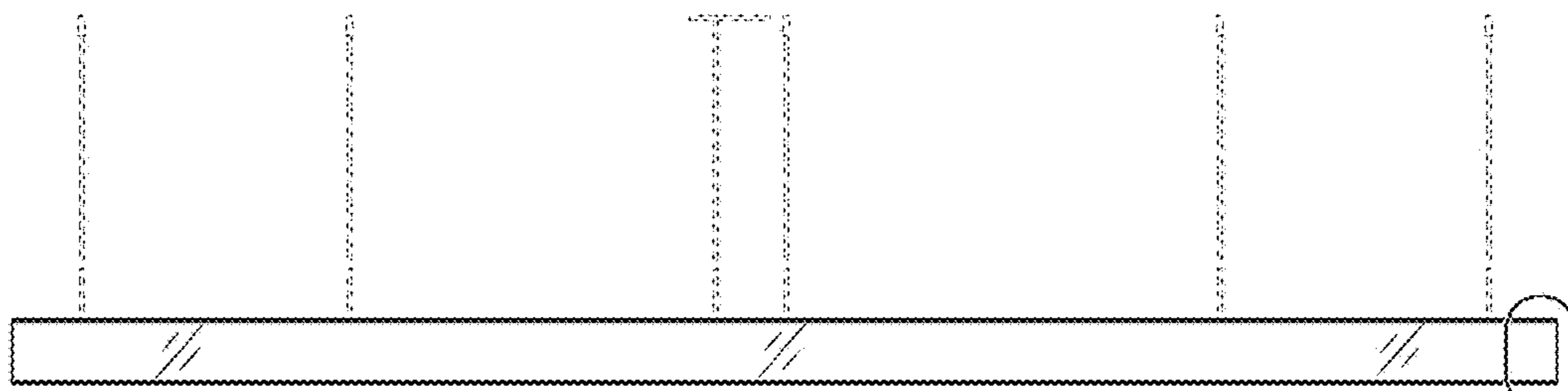

FIG. 151

FIG. 152

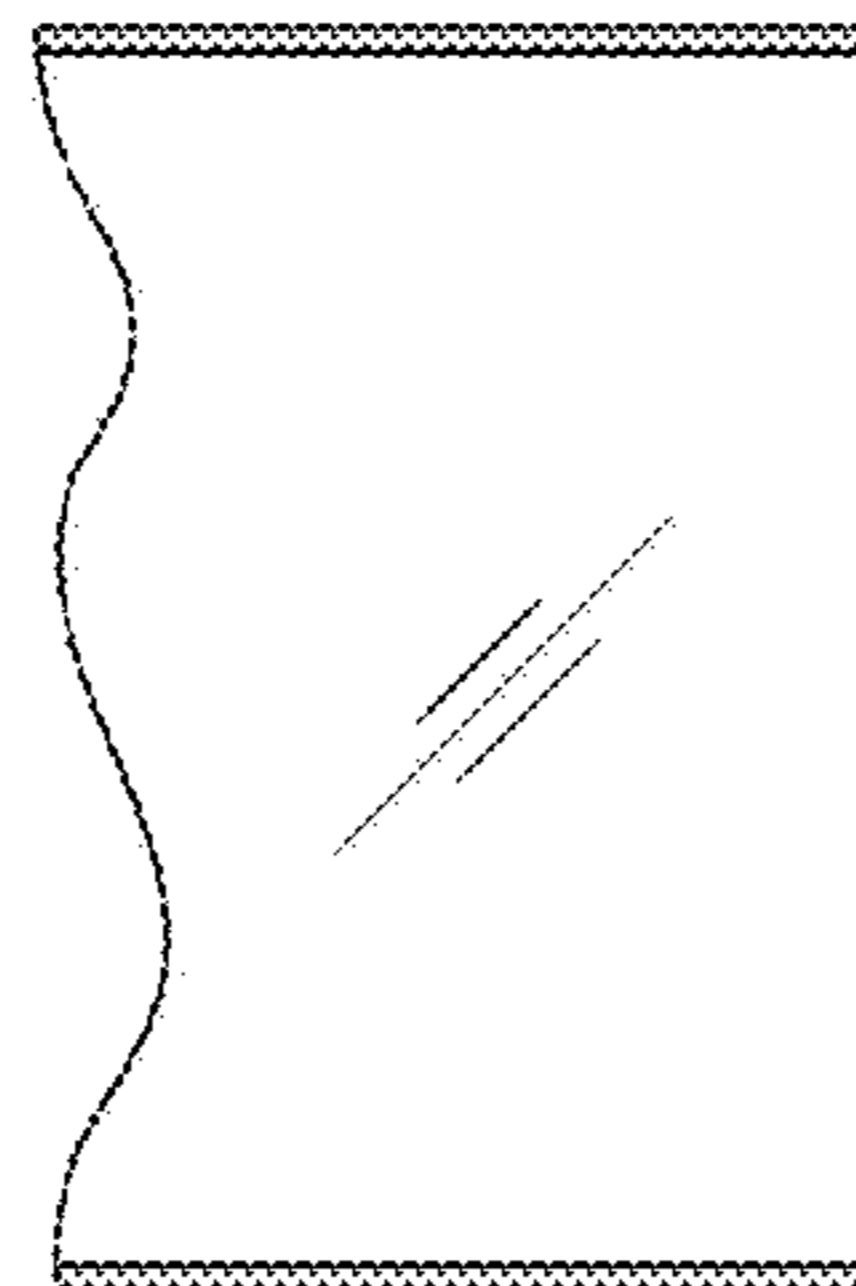

FIG. 152

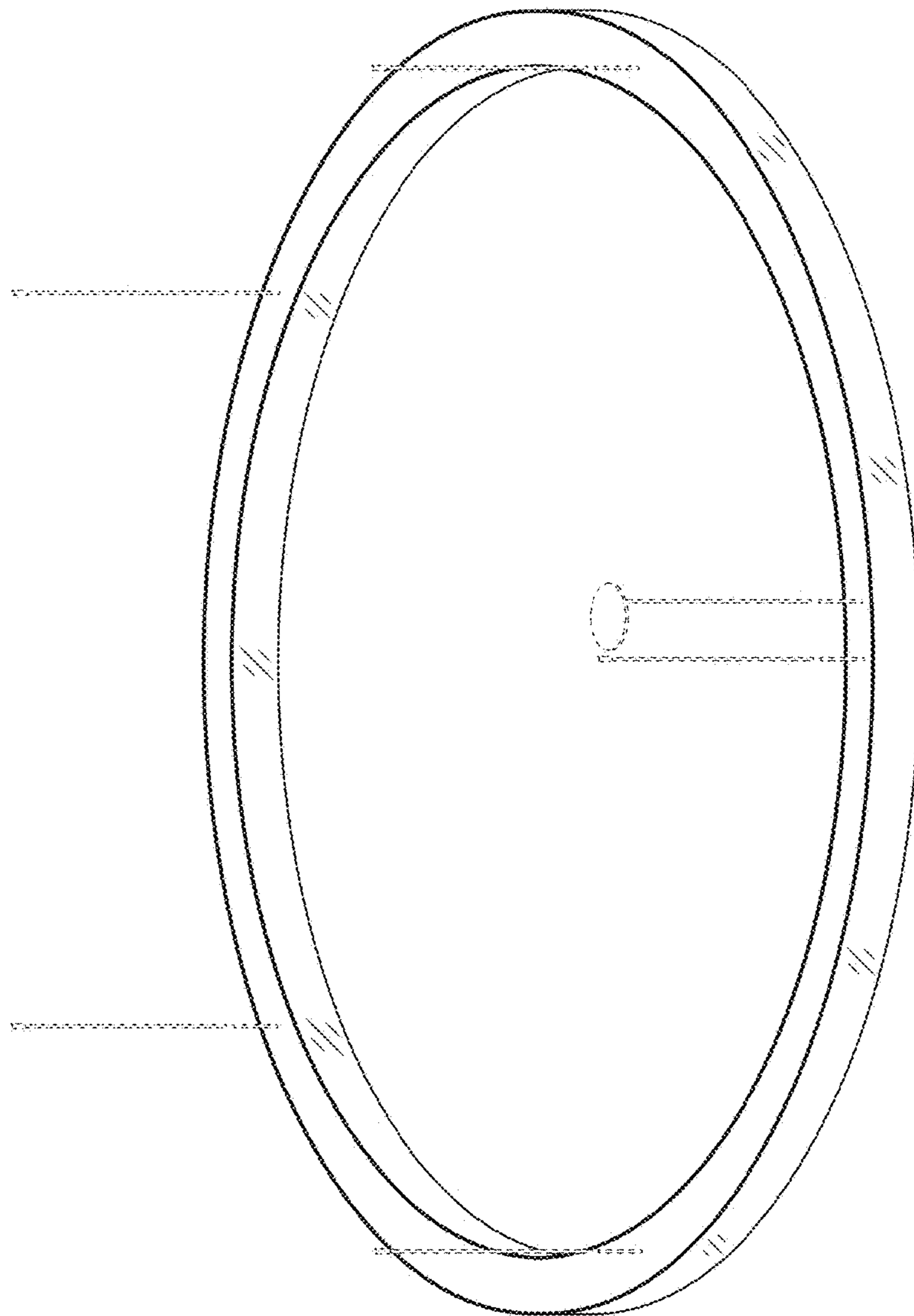
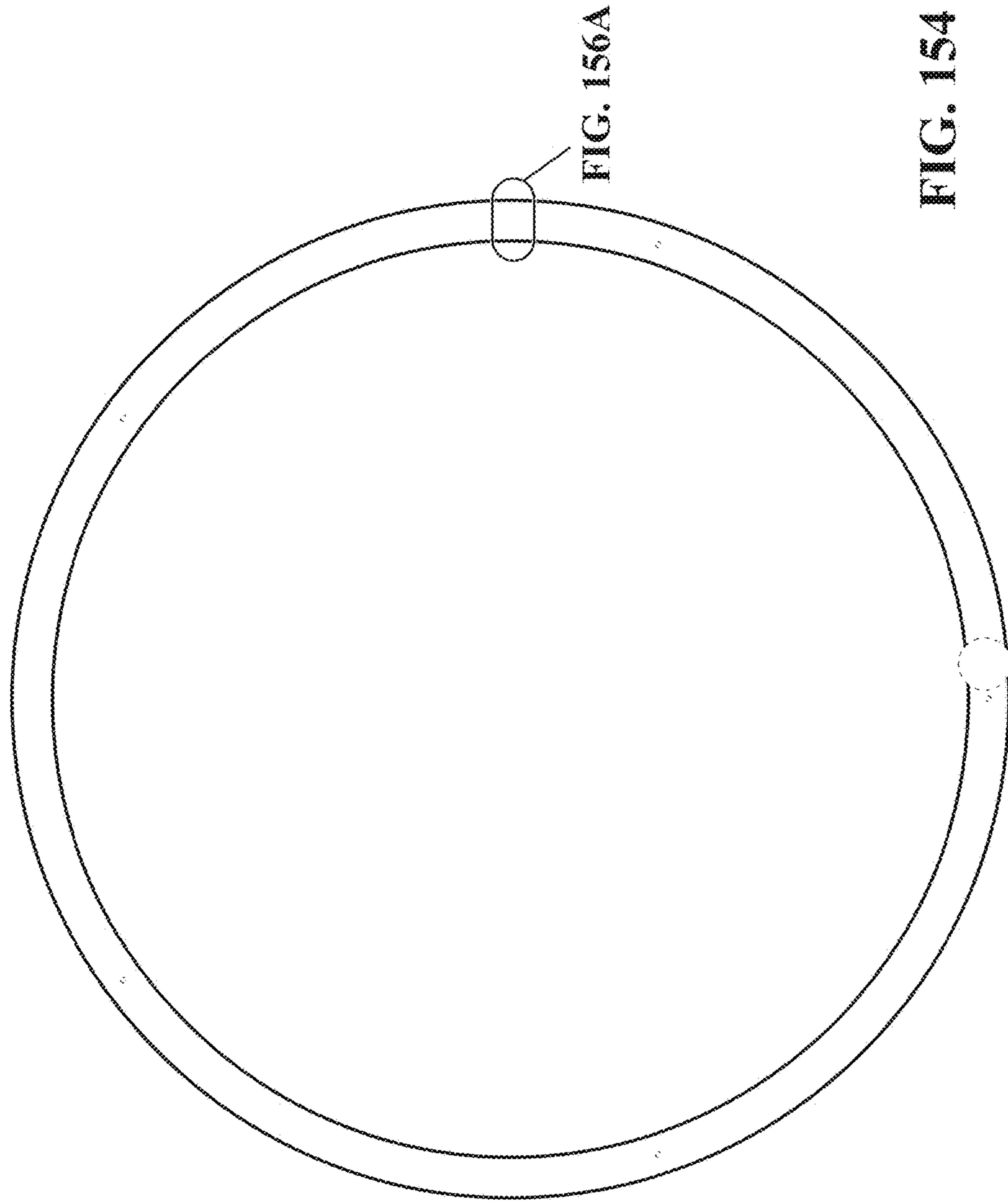

FIG. 153



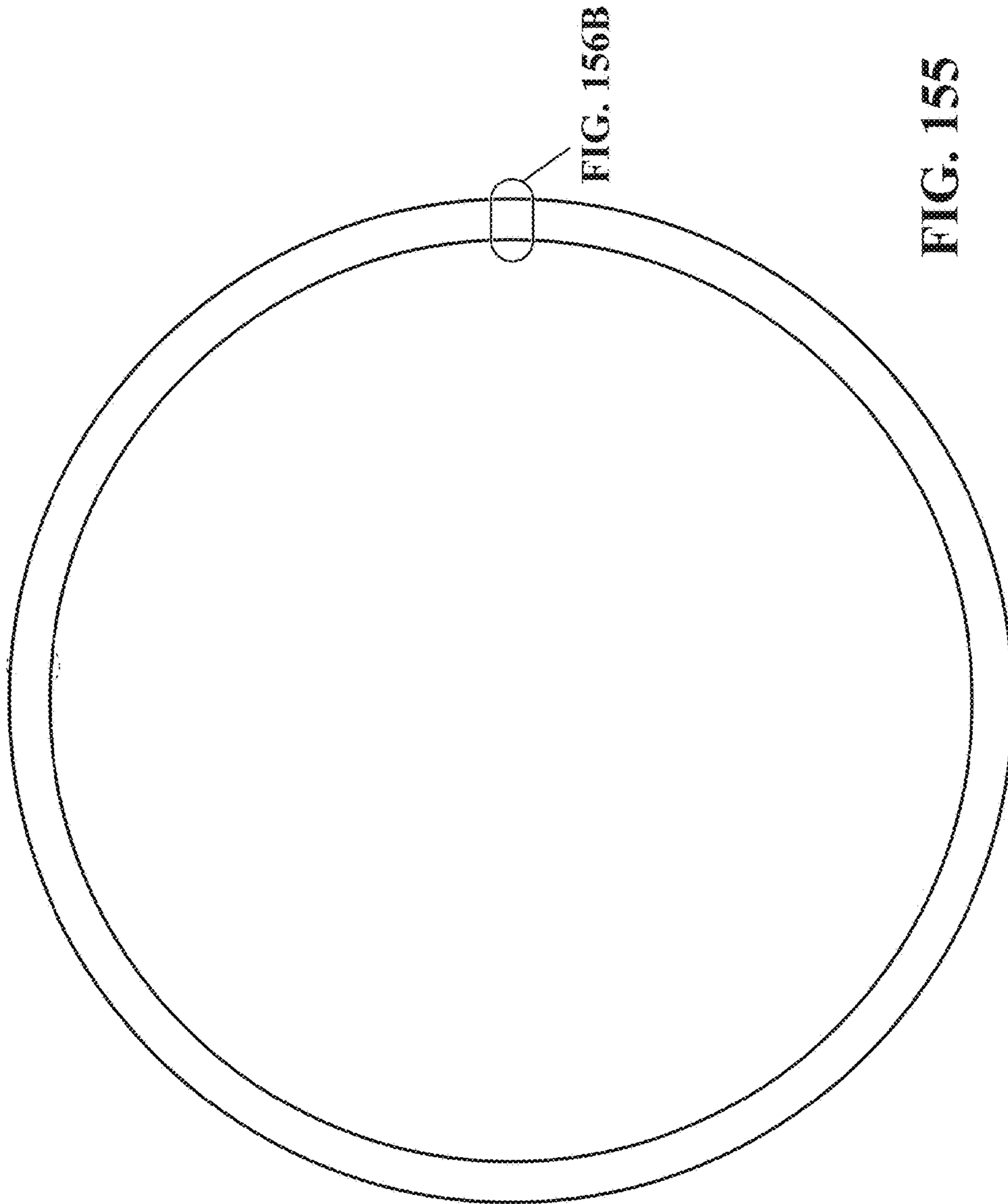

FIG. 156B

FIG. 155

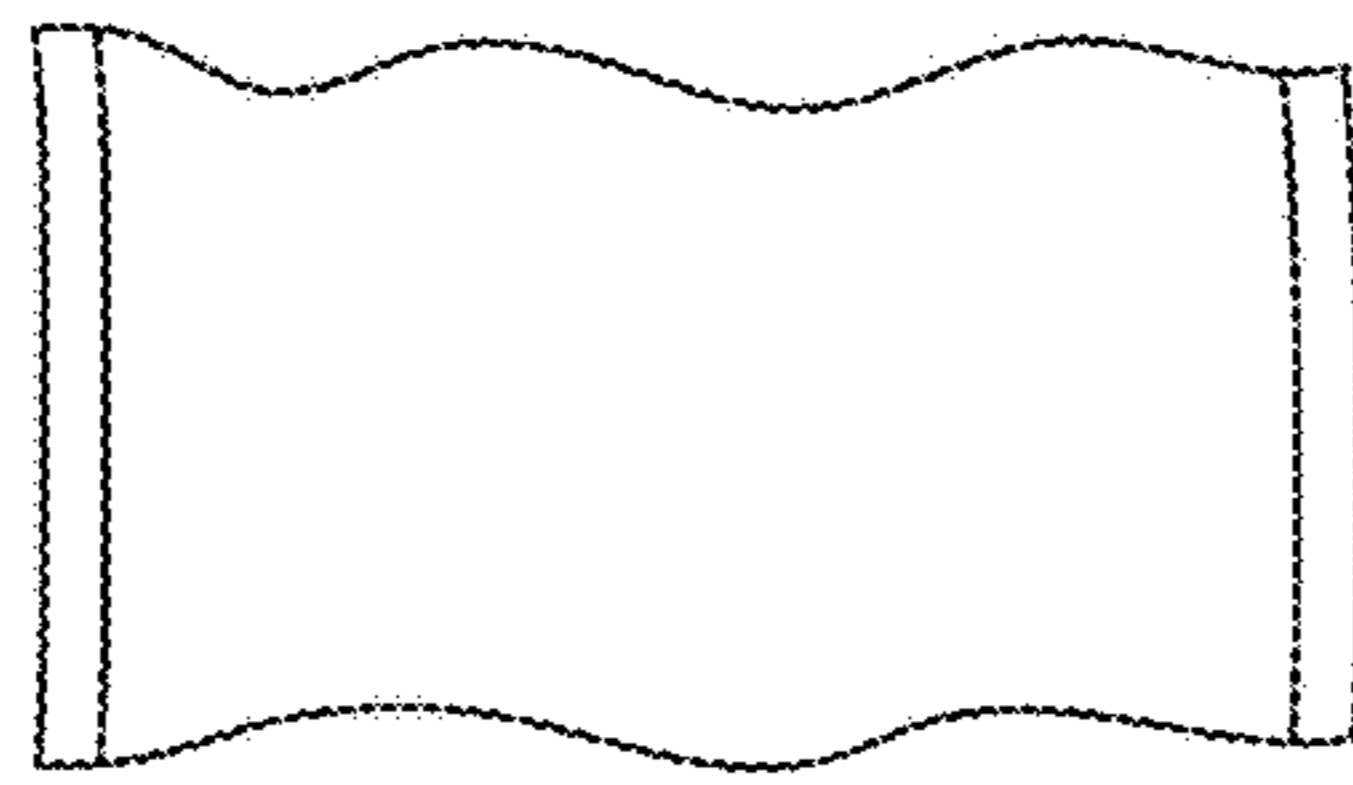

FIG. 156A

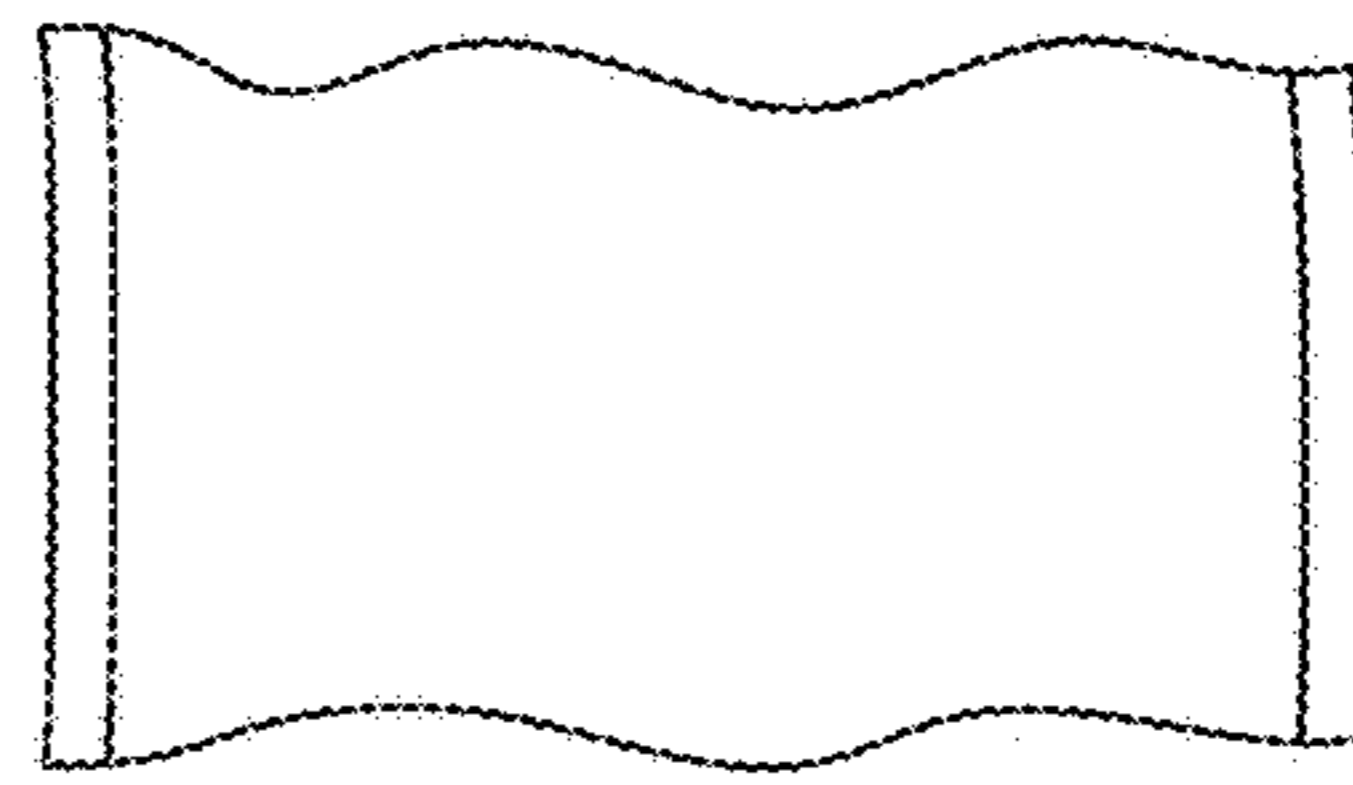

FIG. 156B

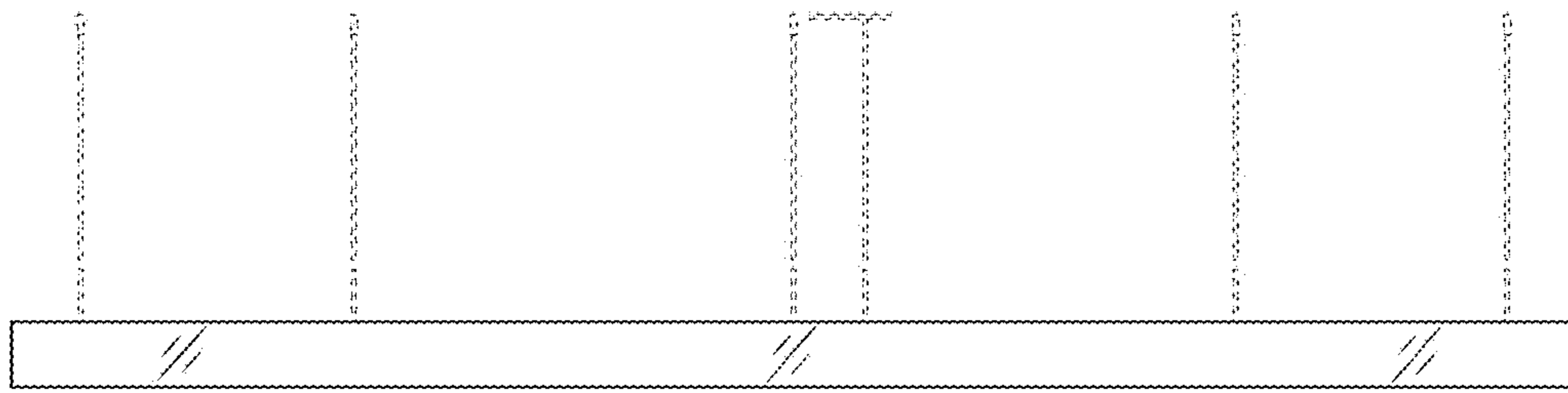

FIG. 157

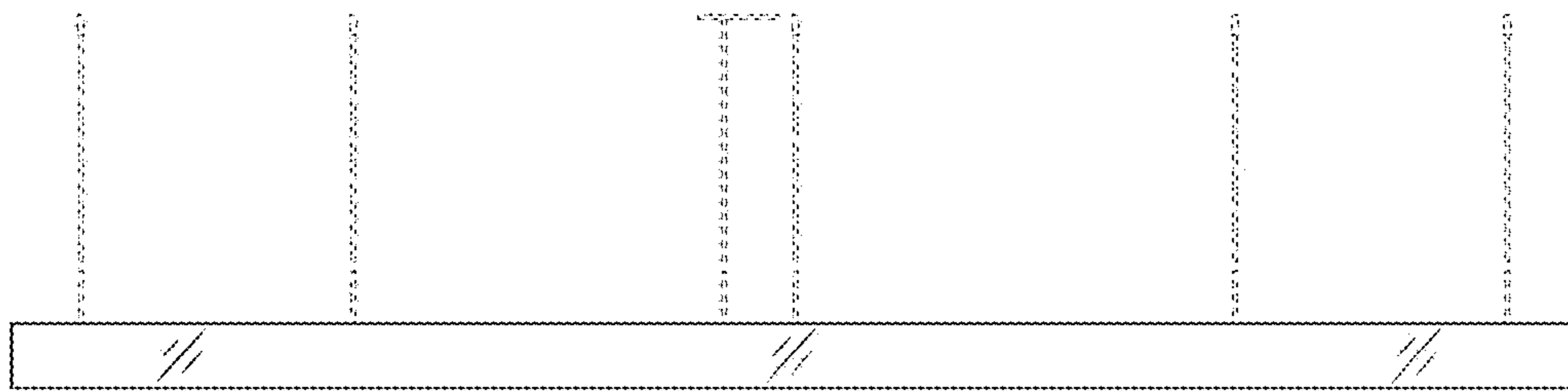

FIG. 158

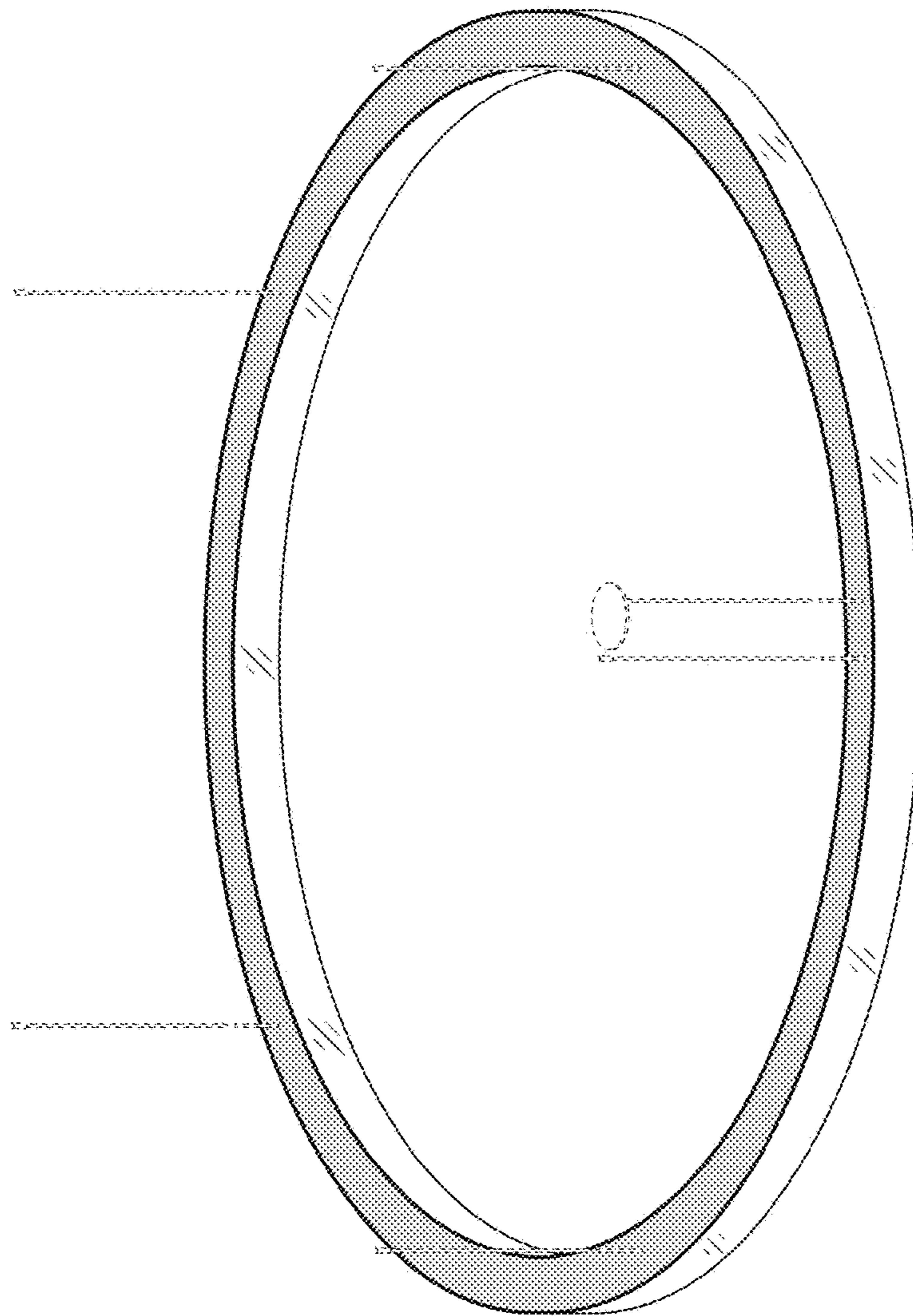
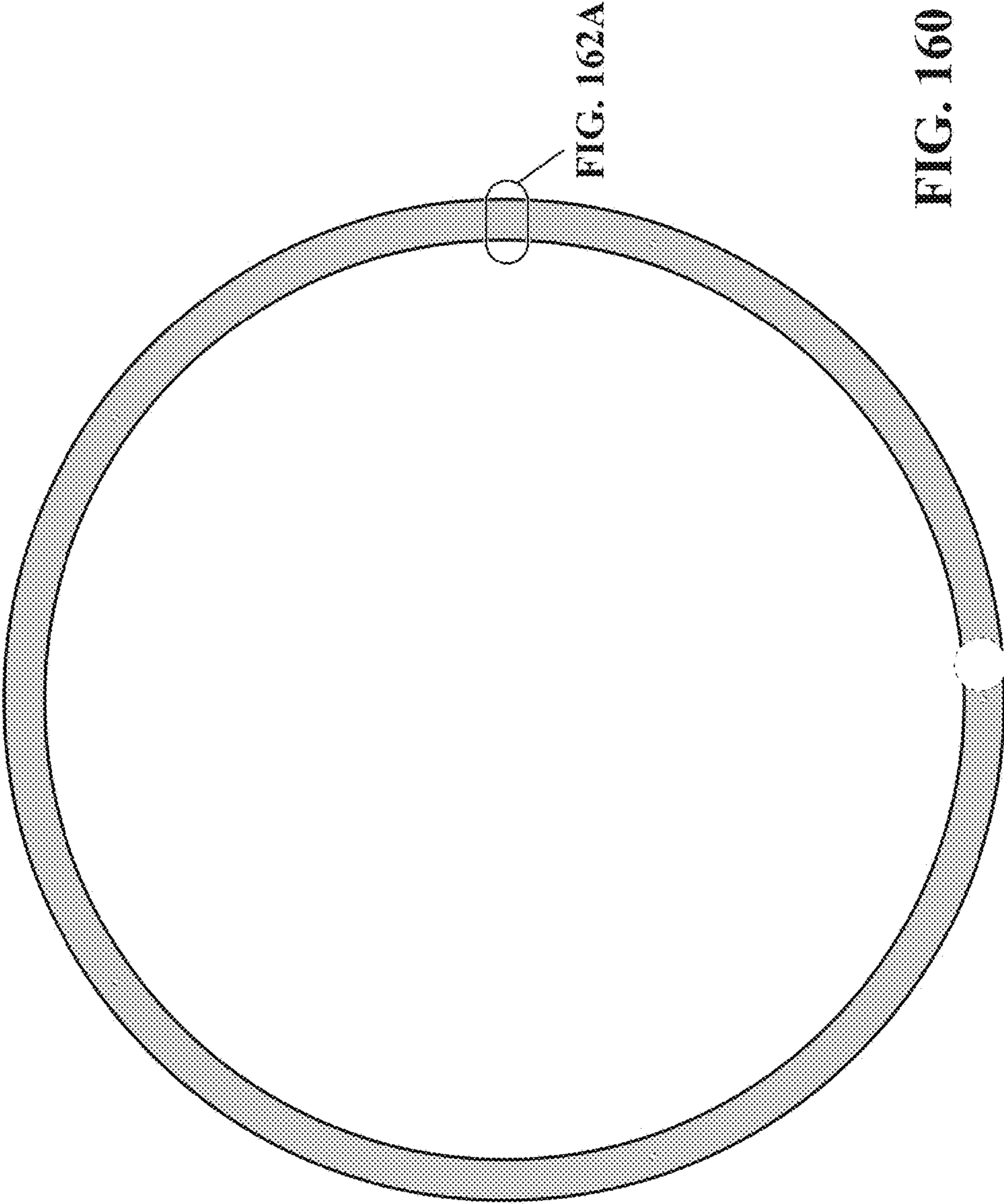
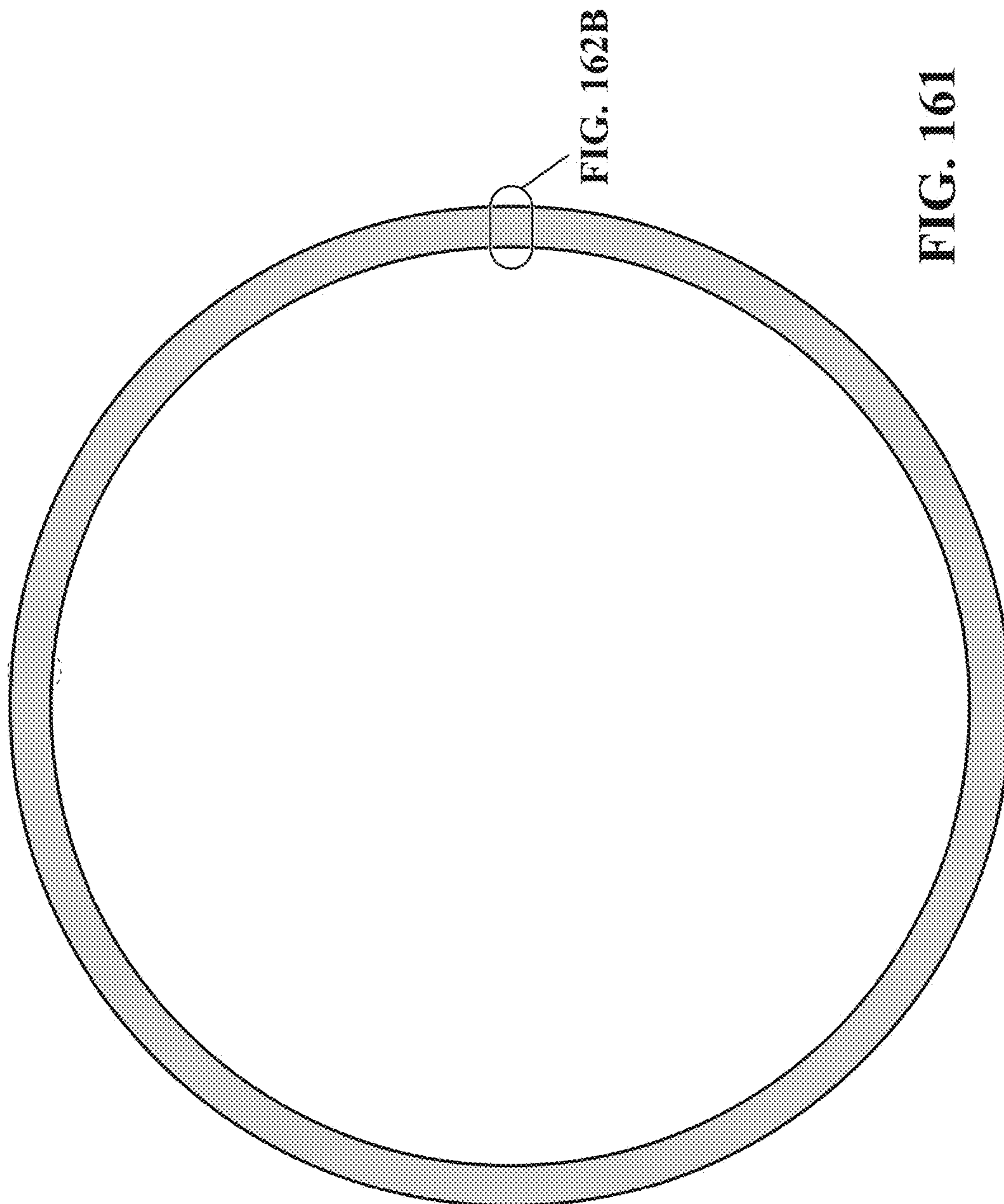

FIG. 159





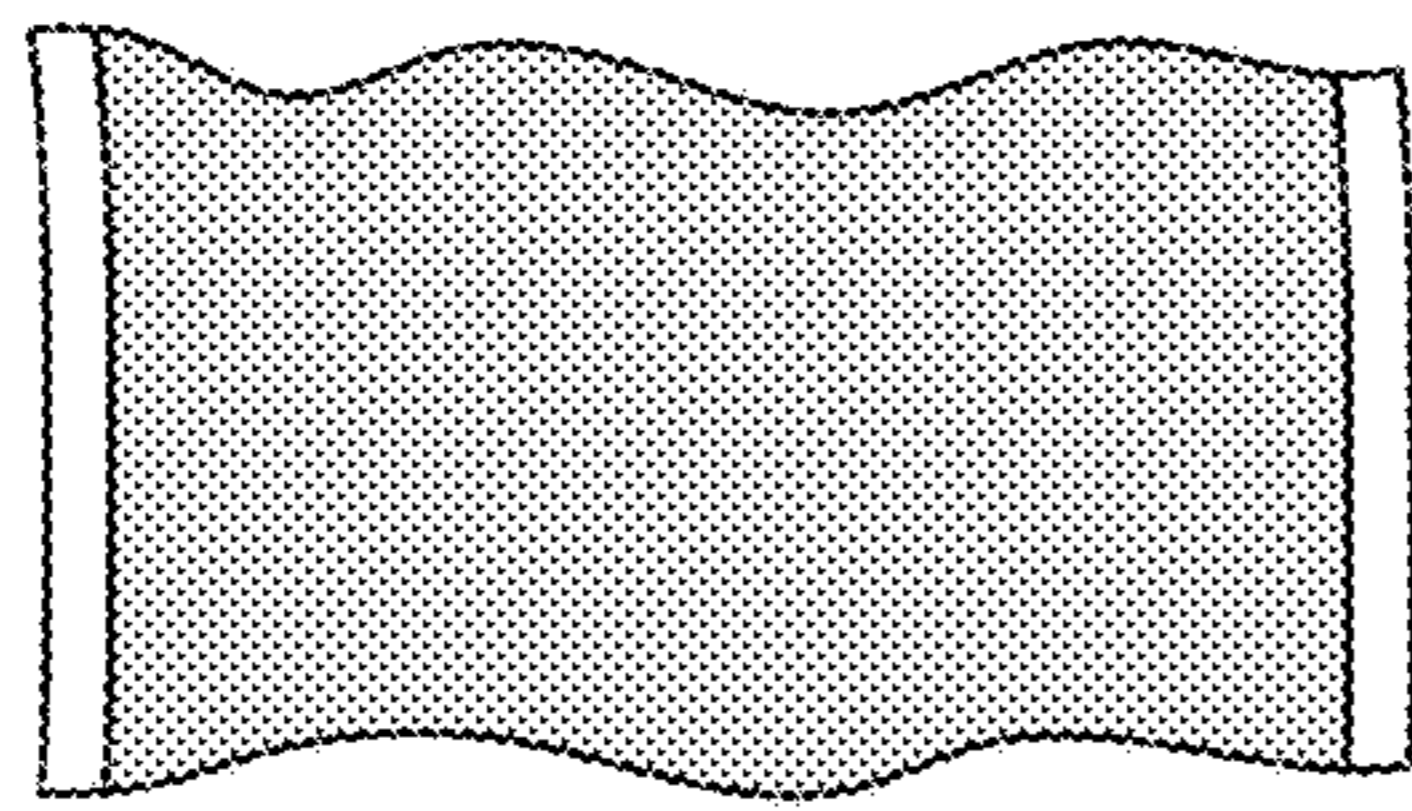

FIG. 162A

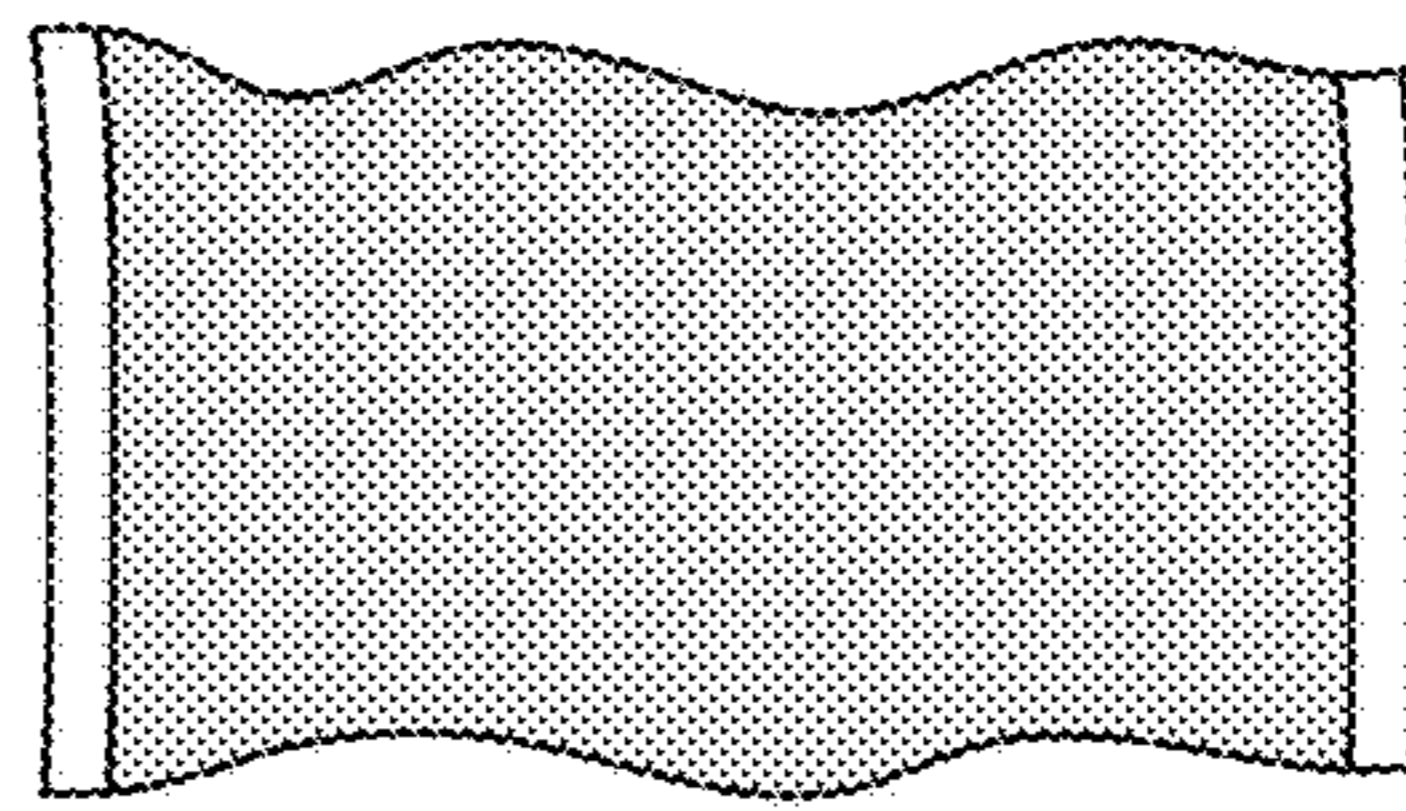

FIG. 162B

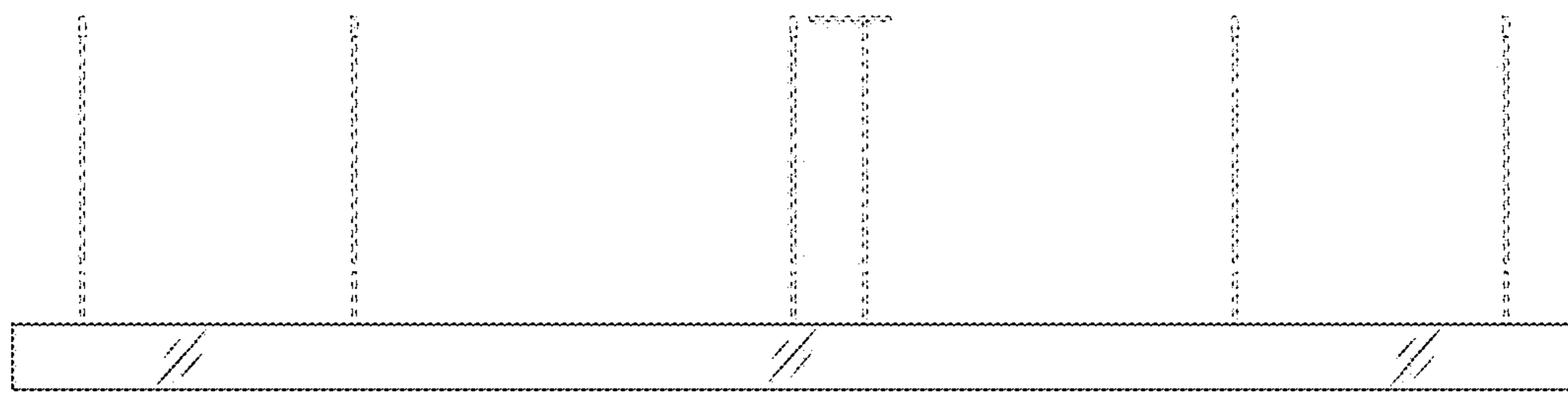

FIG. 163

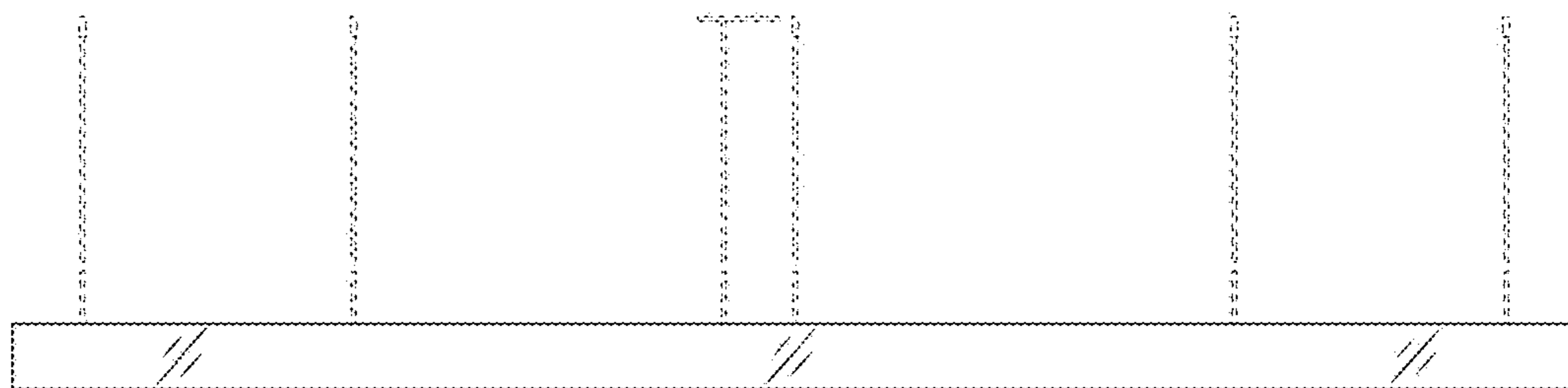

FIG. 164

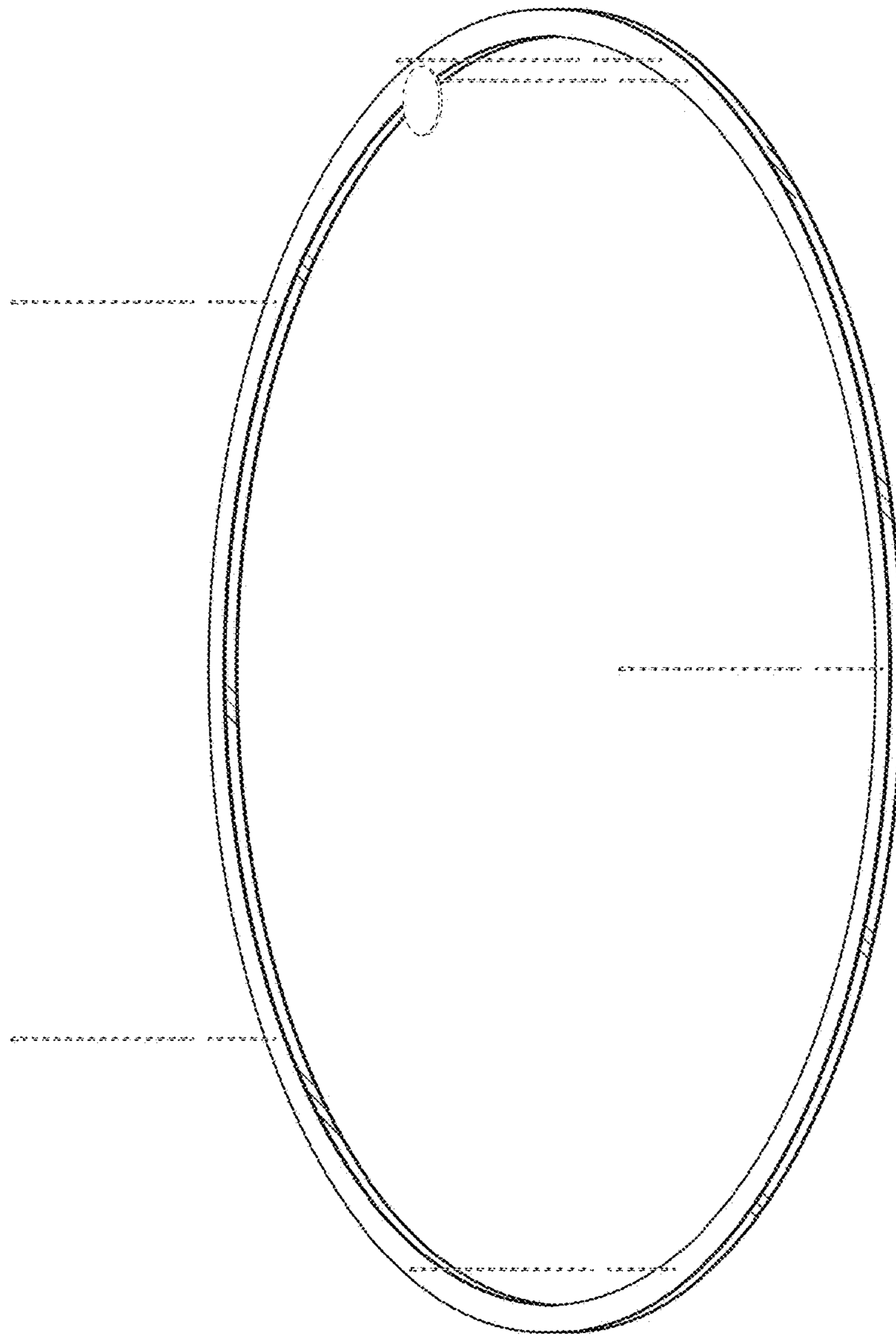

FIG. 165

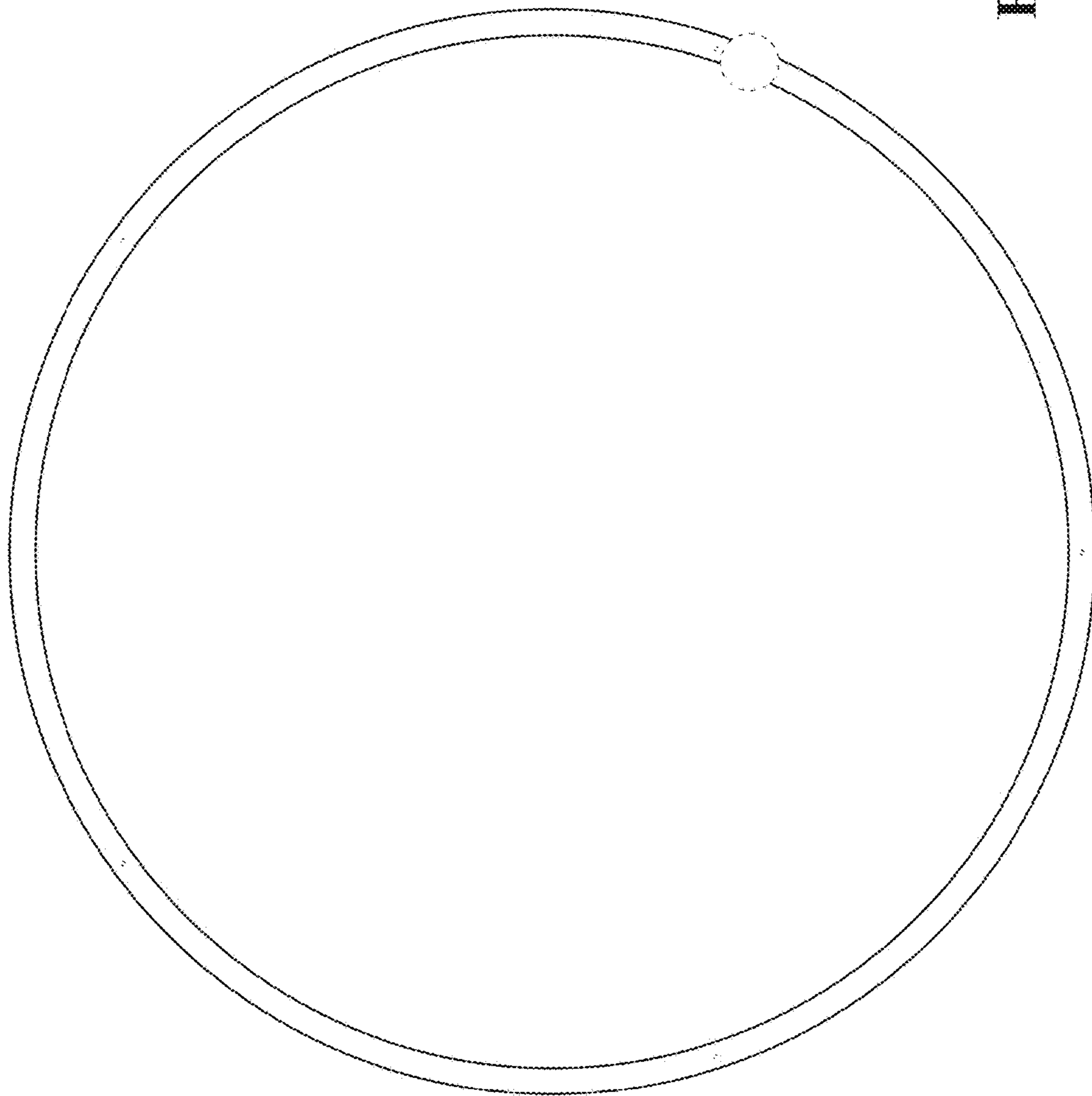

FIG. 166

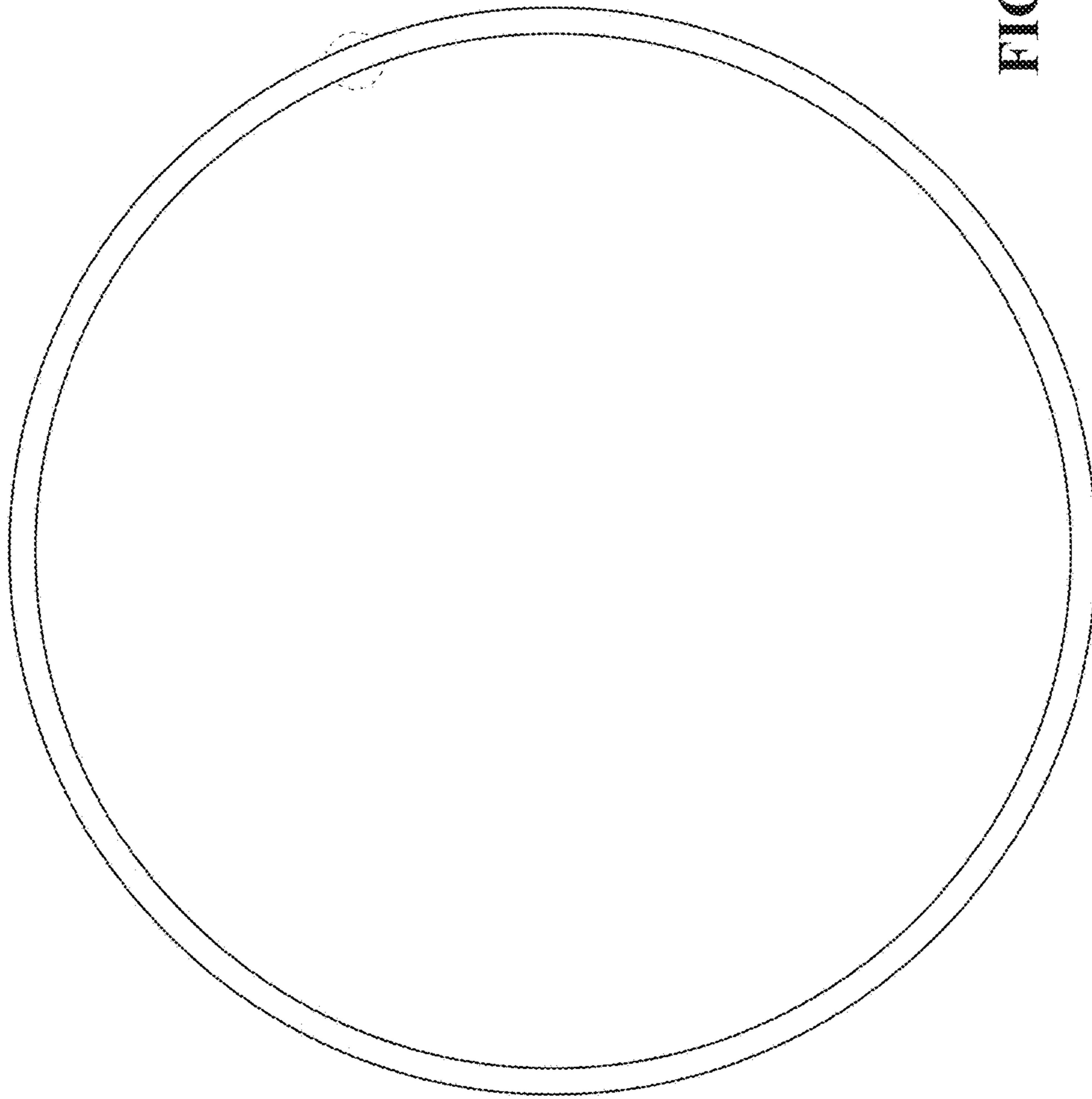

FIG. 167

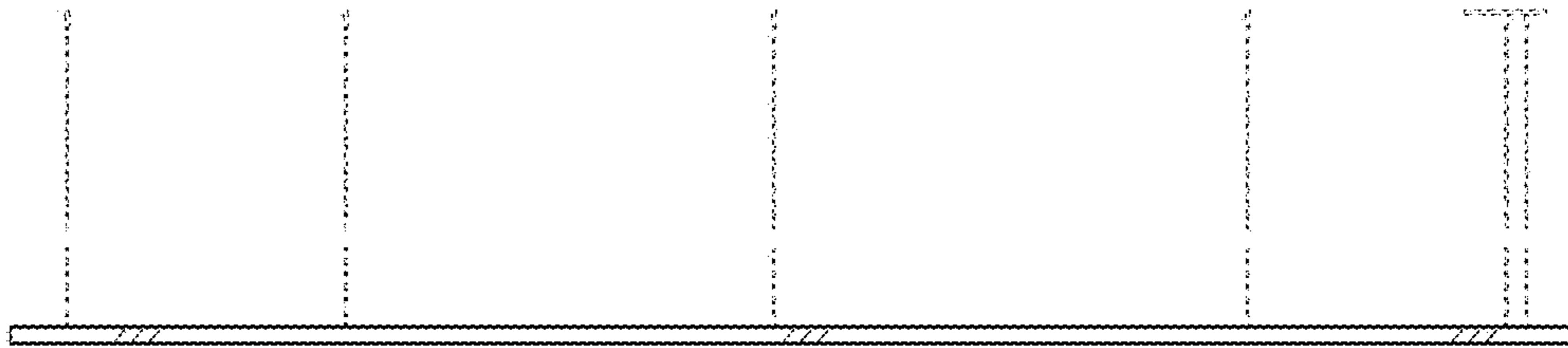

FIG. 168

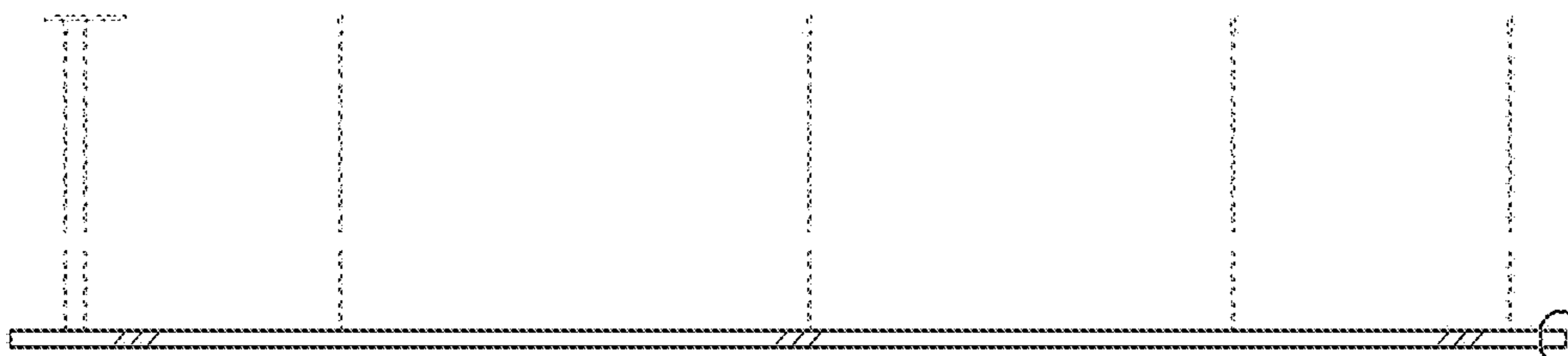

FIG. 169

FIG. 170



FIG. 170

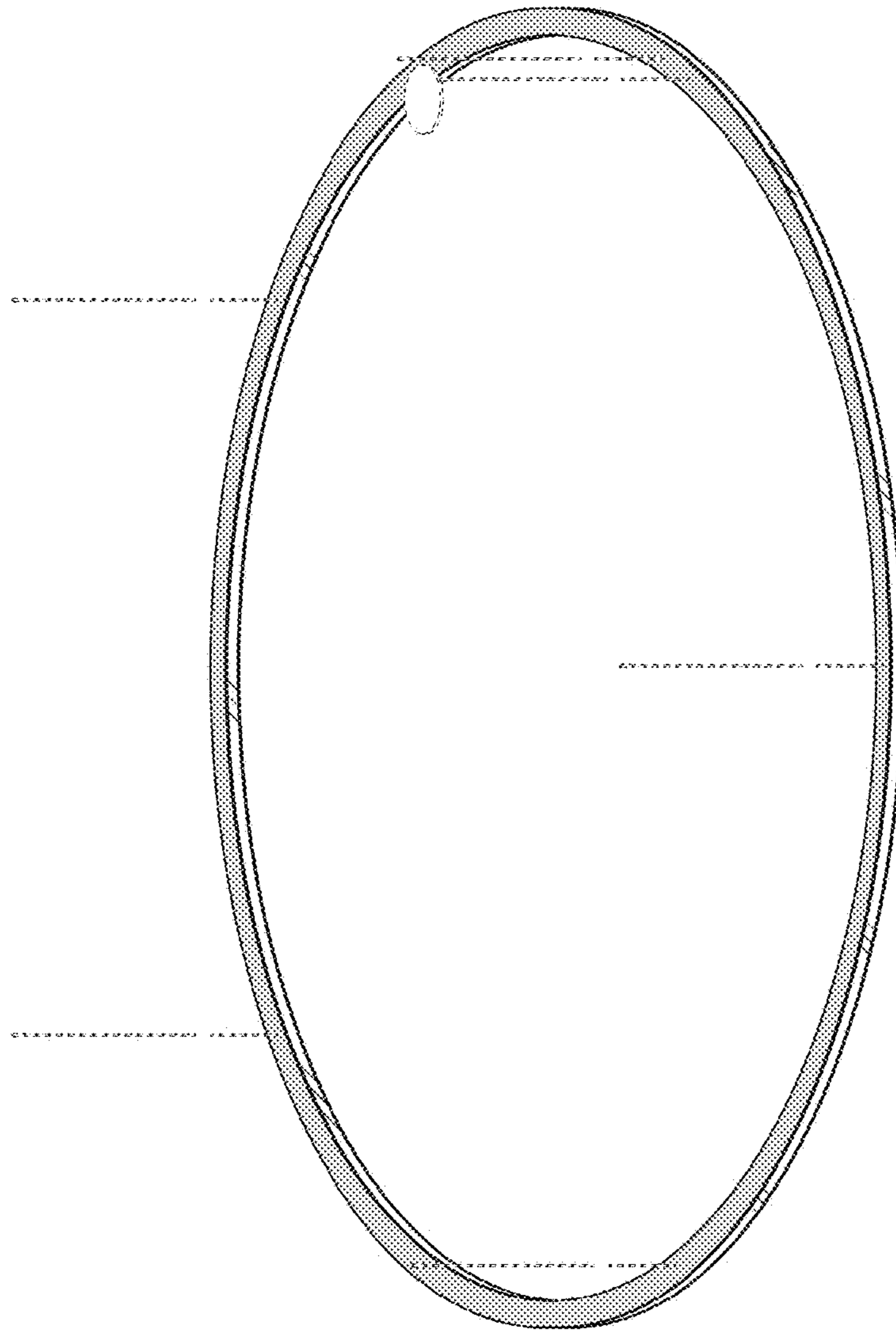

FIG. 171

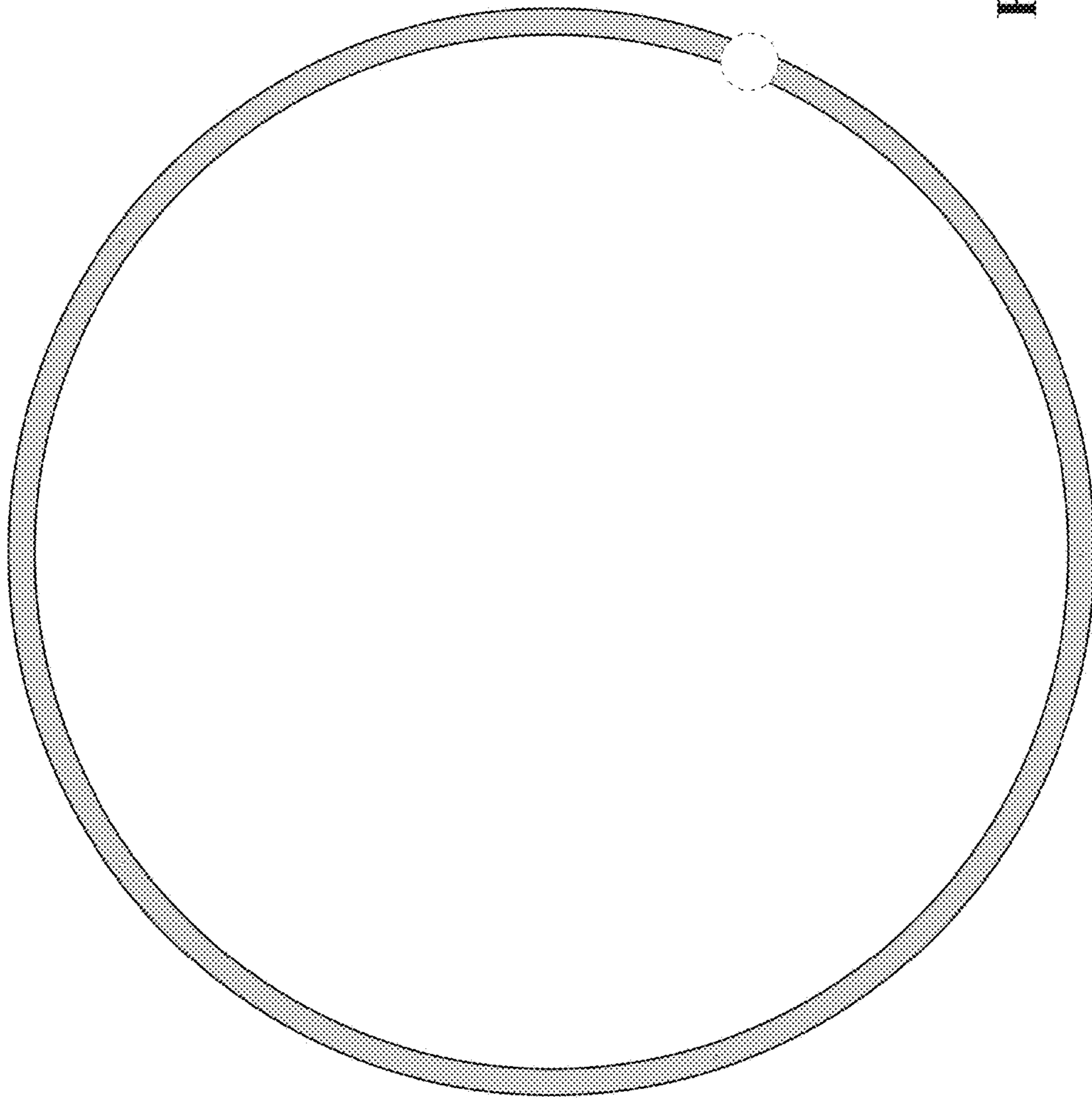

FIG. 172

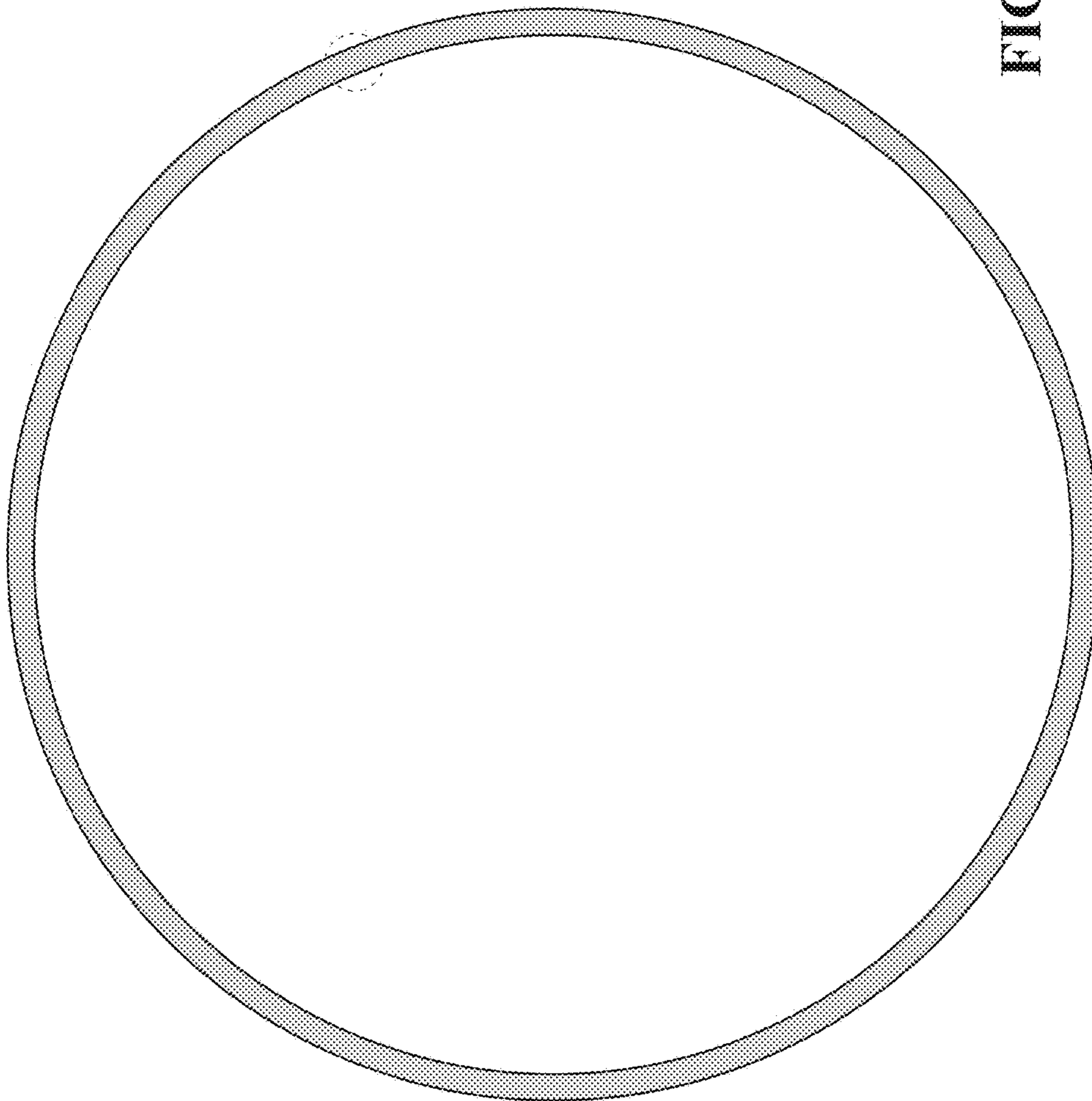

FIG. 173

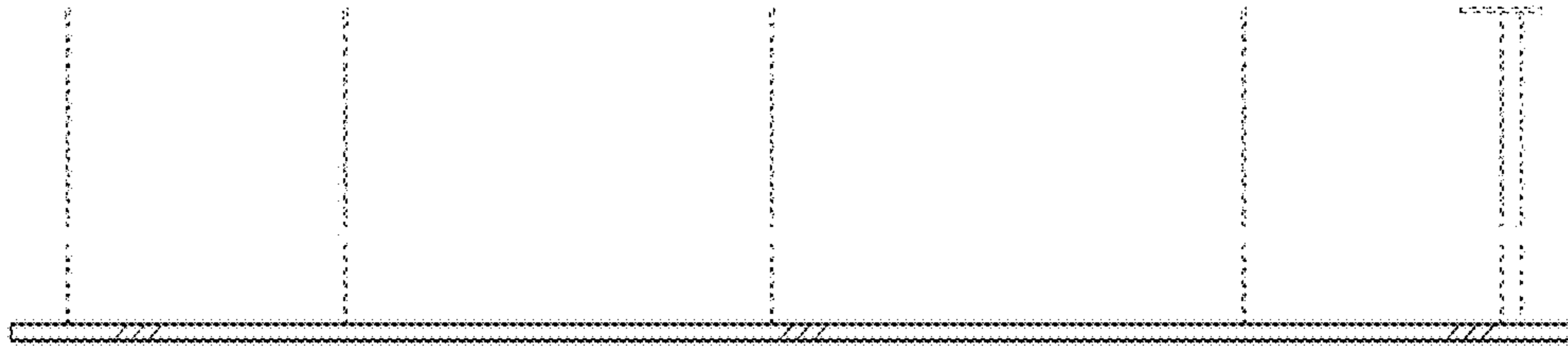

FIG. 174

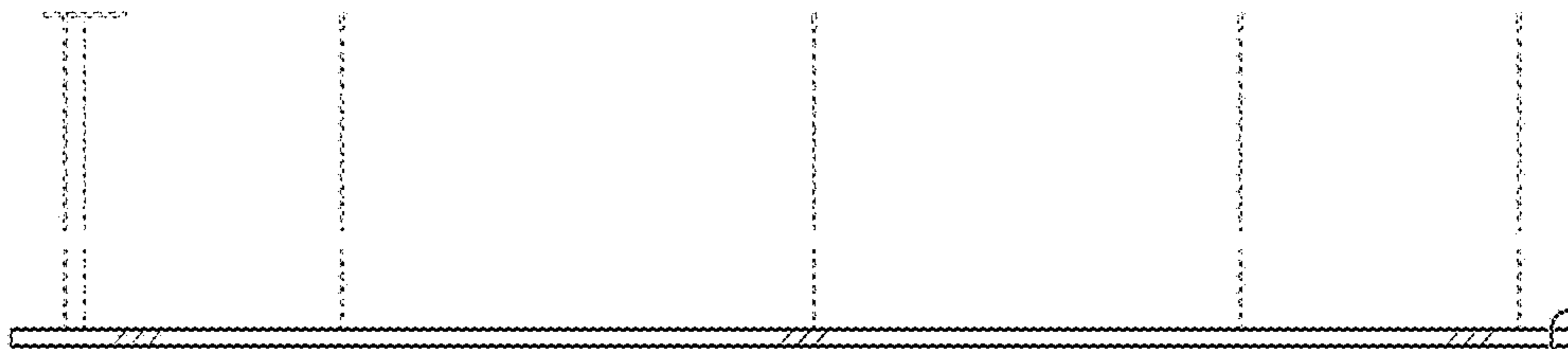

FIG. 175

FIG. 176



FIG. 176

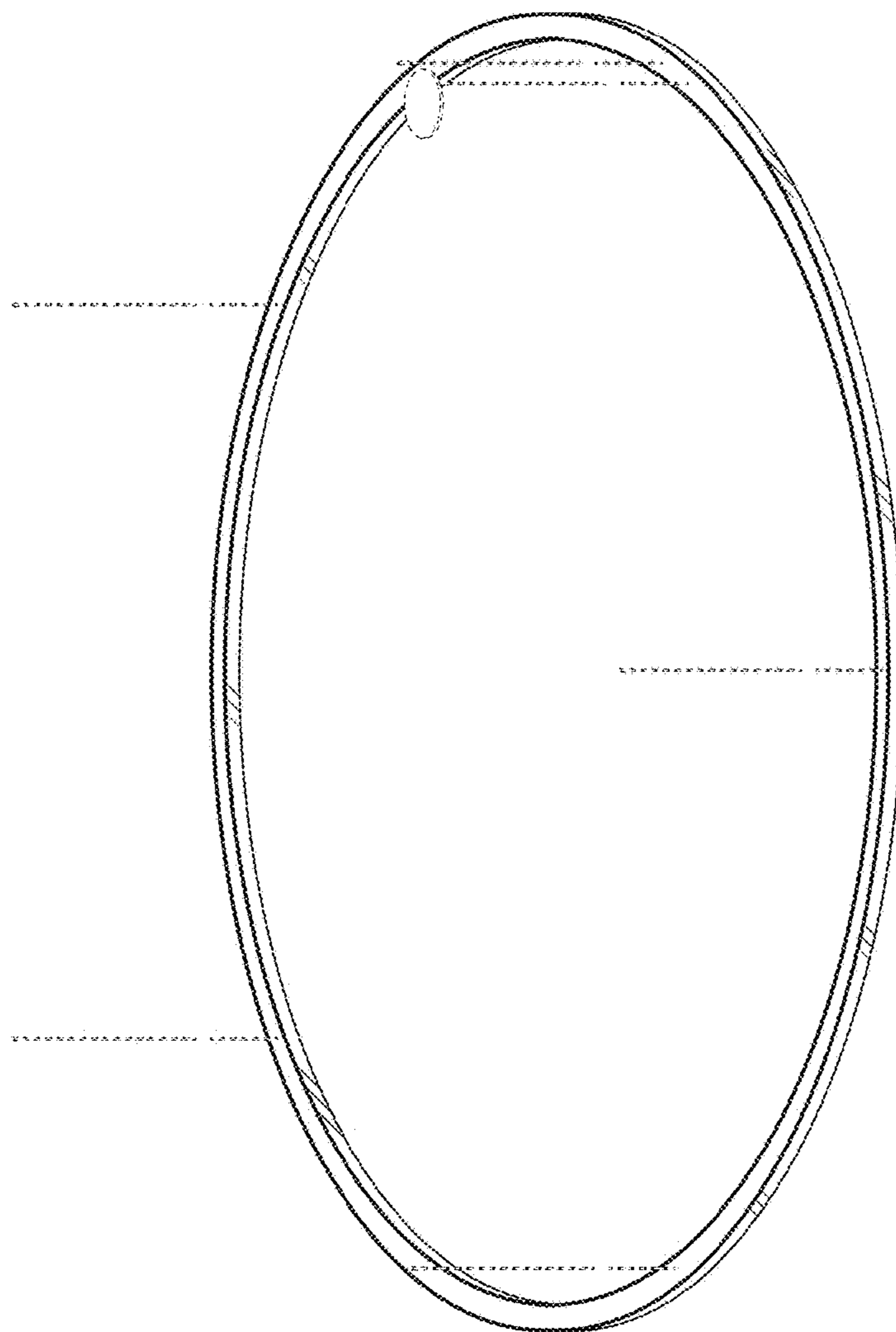
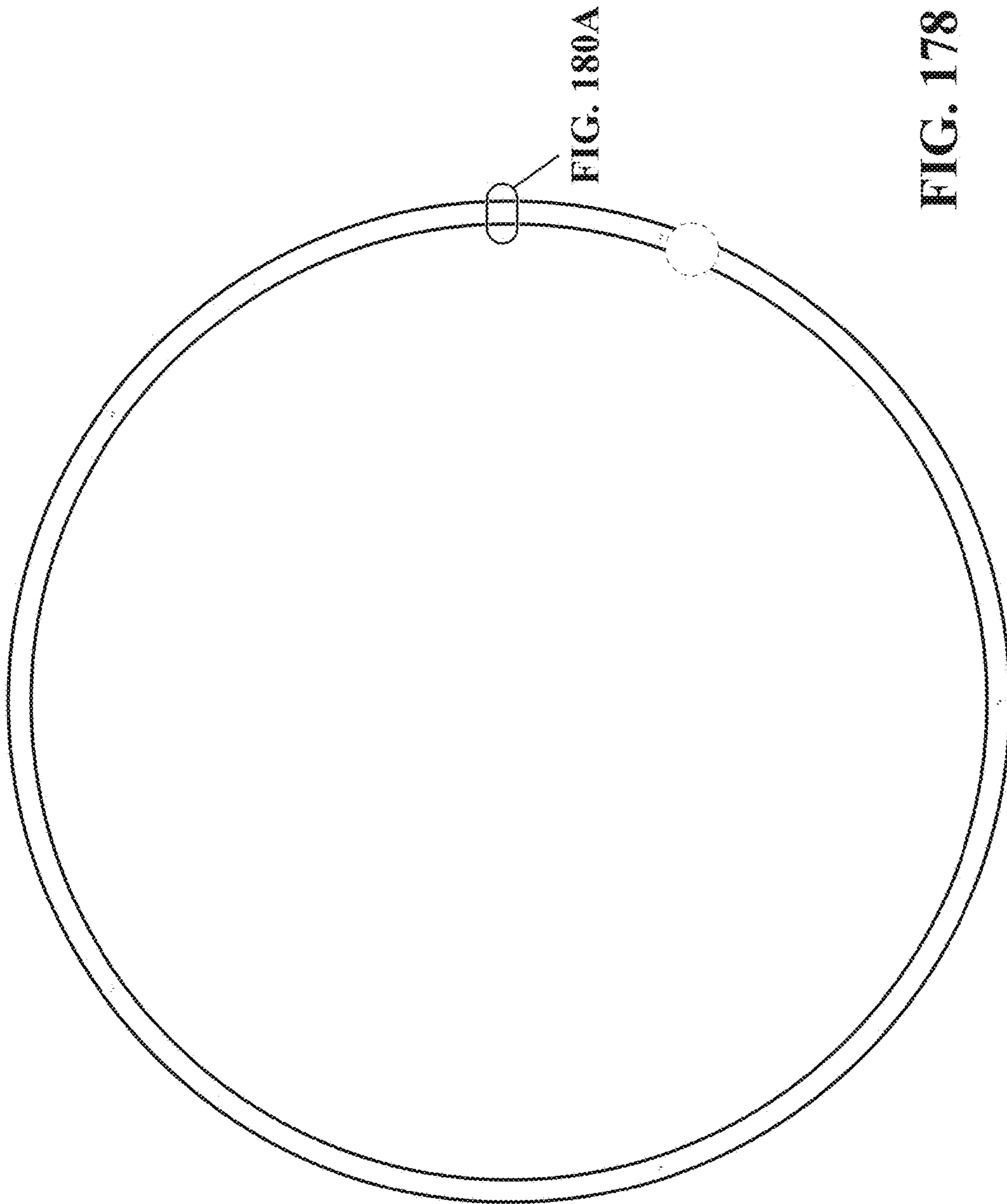

FIG. 177



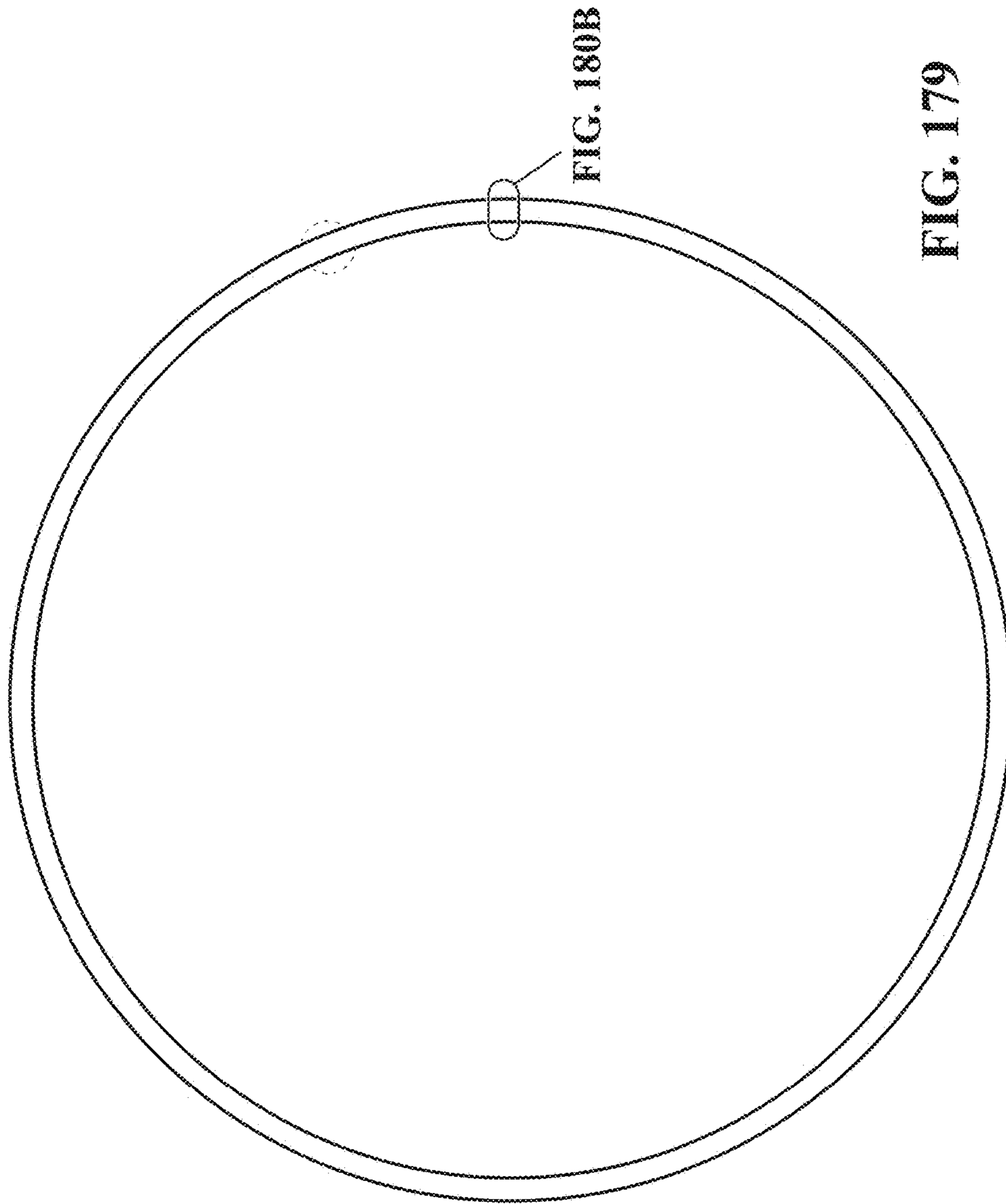

FIG. 180B

FIG. 179

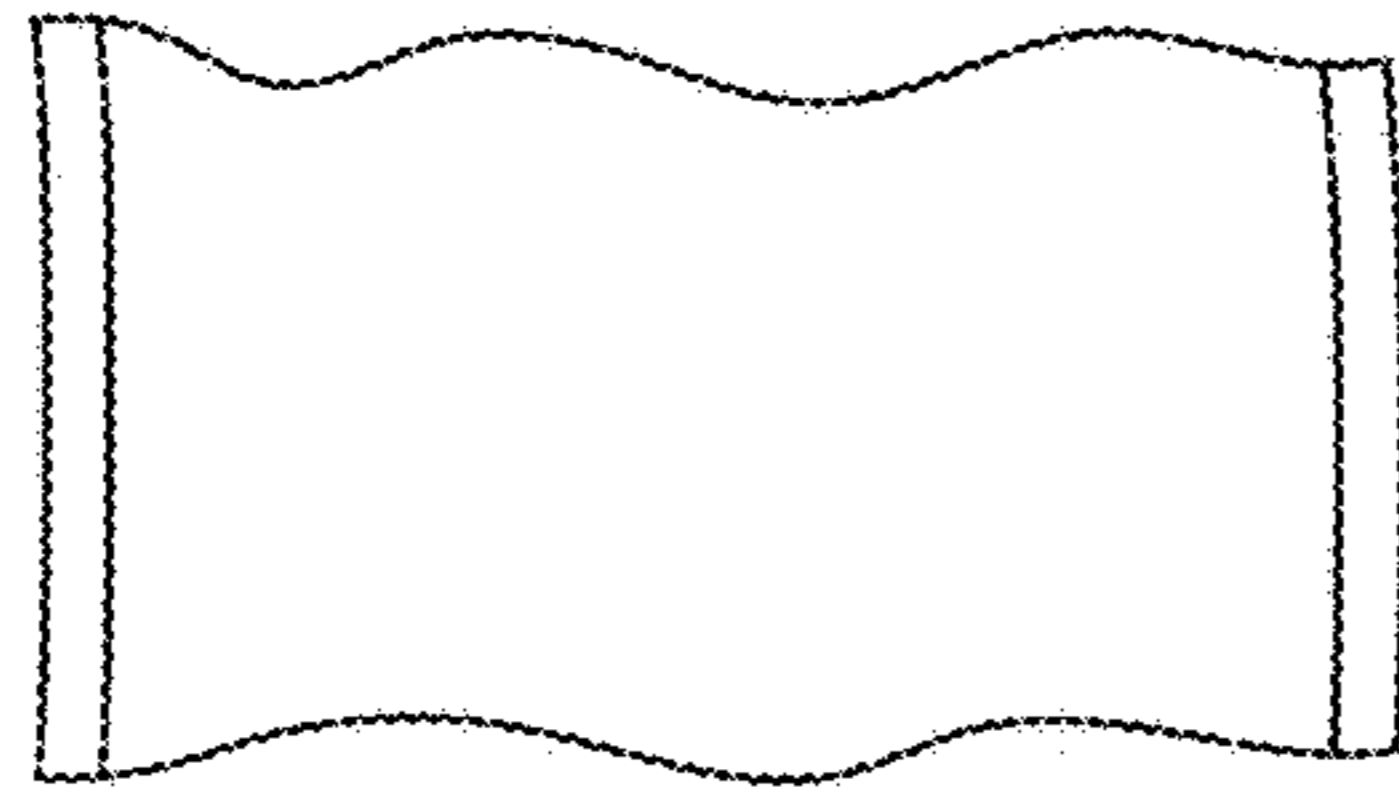

FIG. 180A

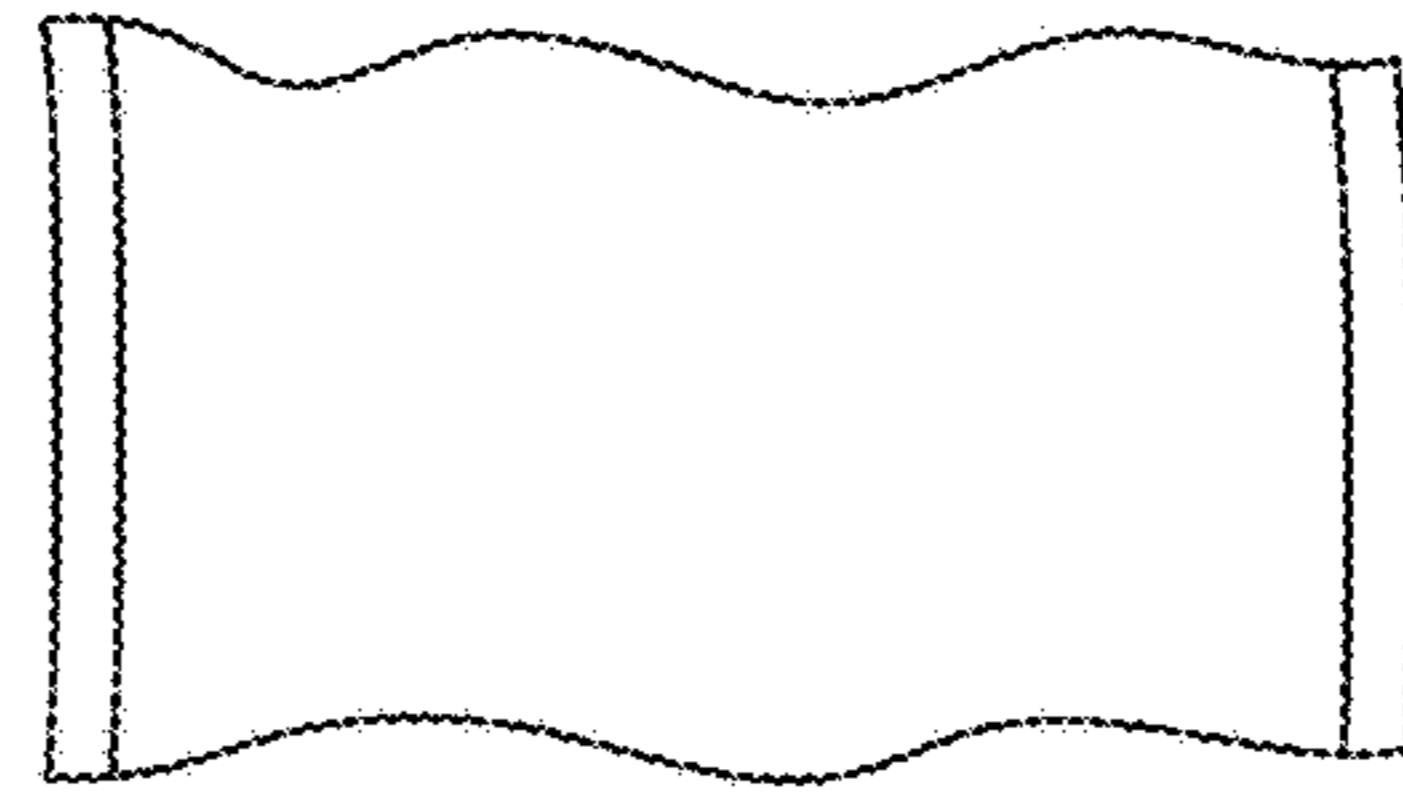

FIG. 180B

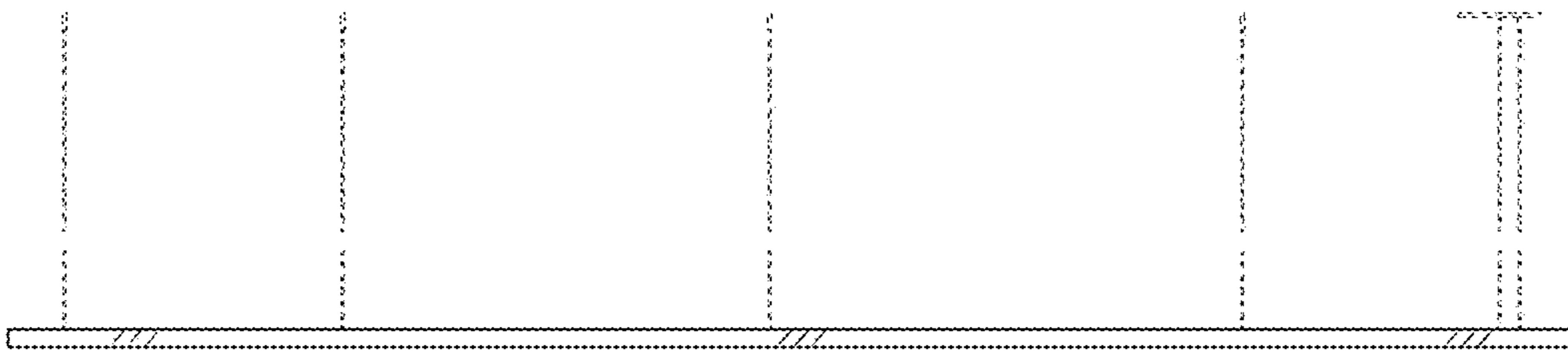

FIG. 181

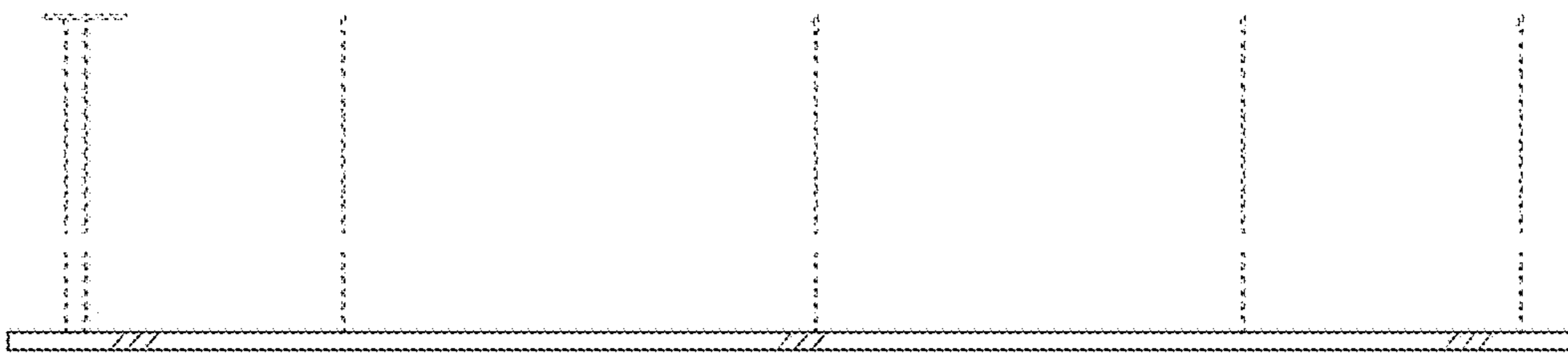

FIG. 182

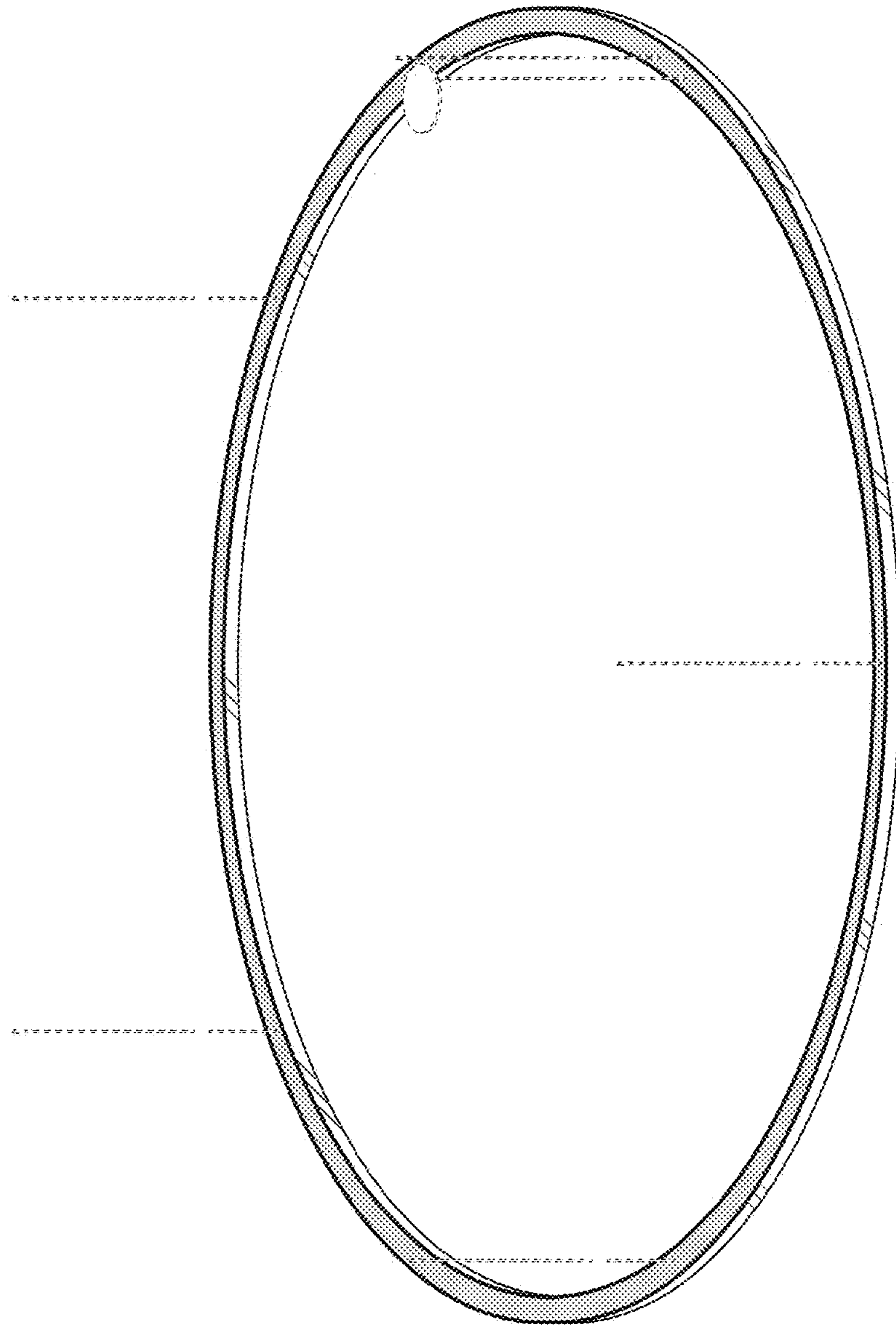

FIG. 183

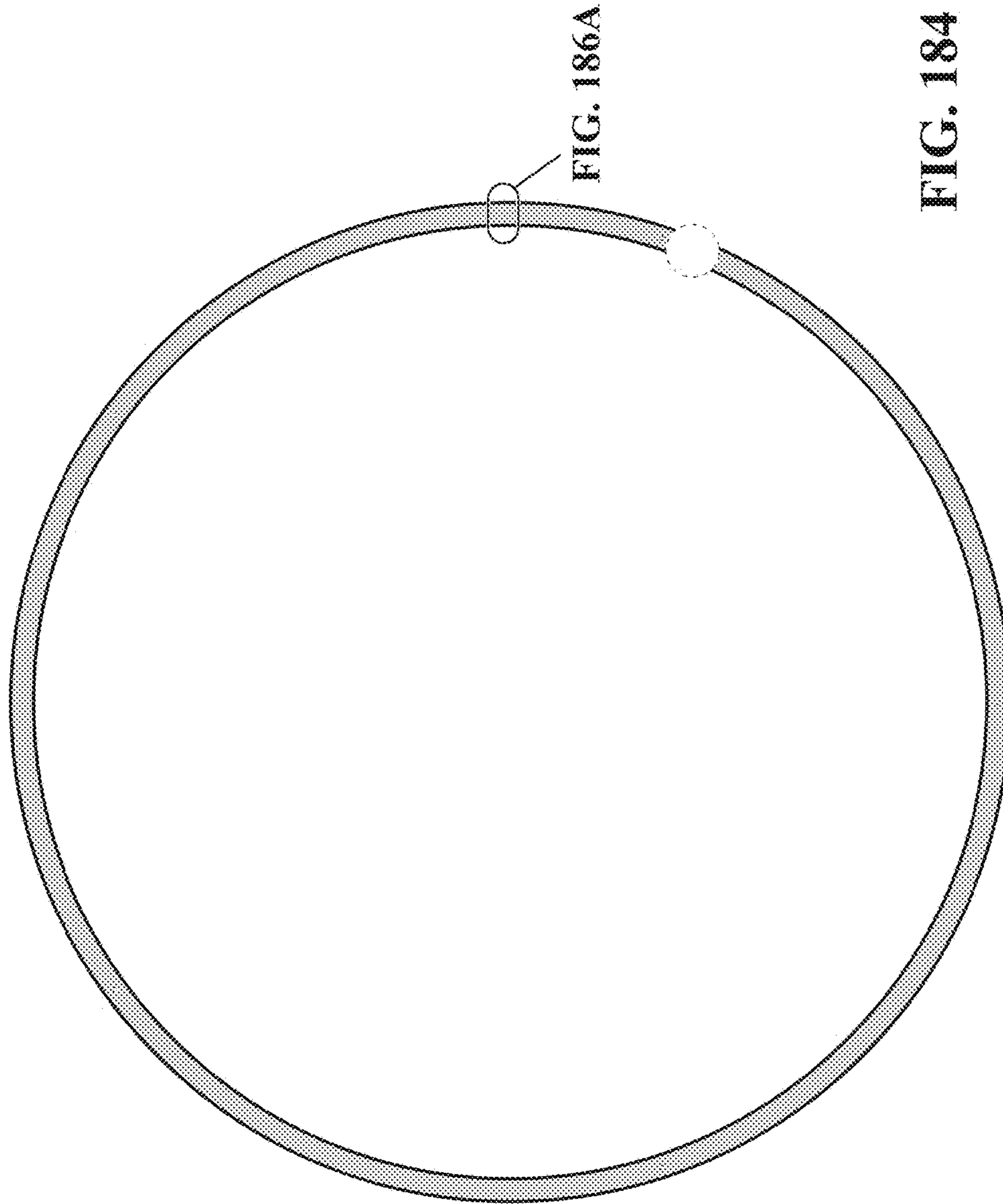

FIG. 186A

FIG. 184

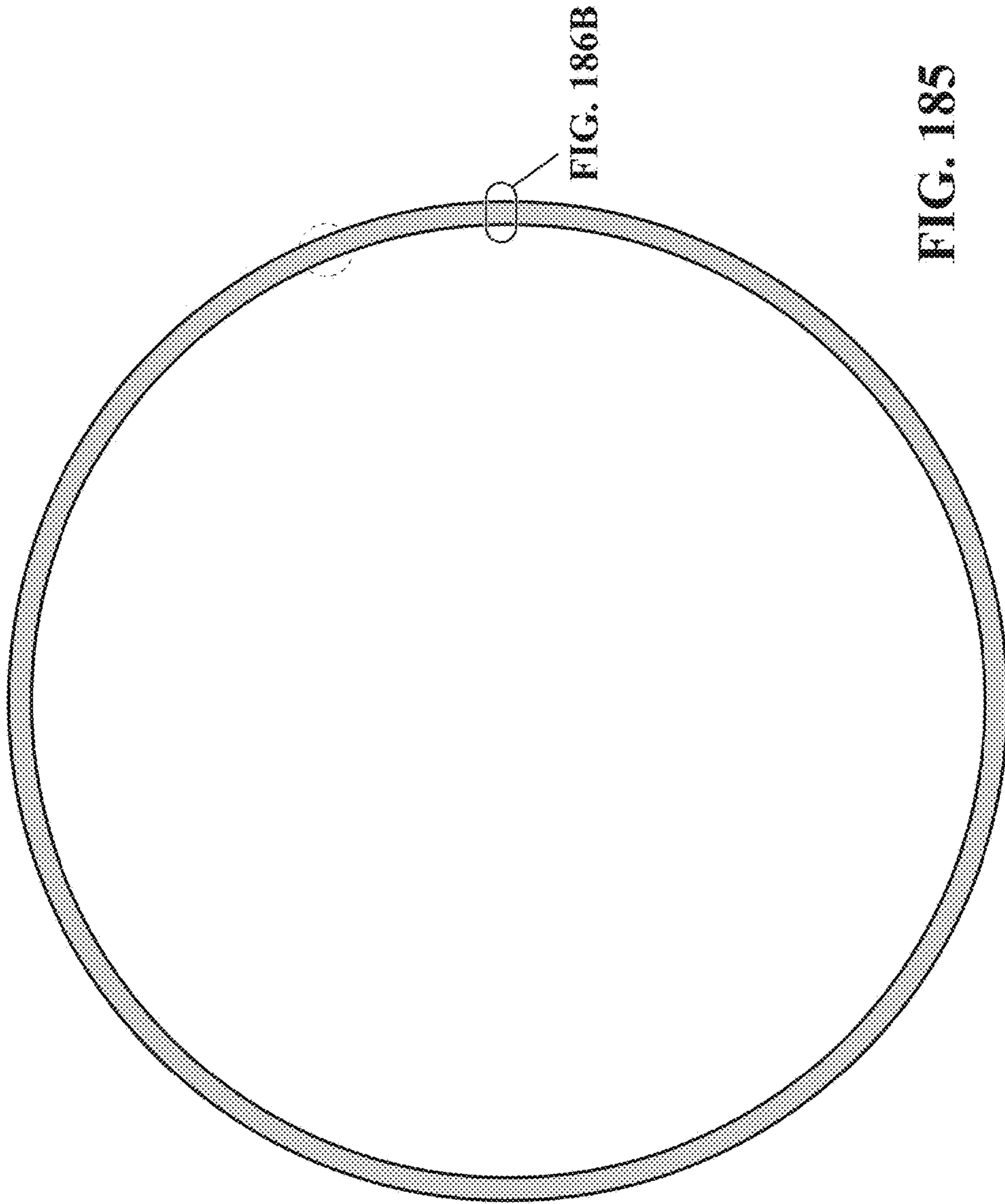

FIG. 186B

FIG. 185

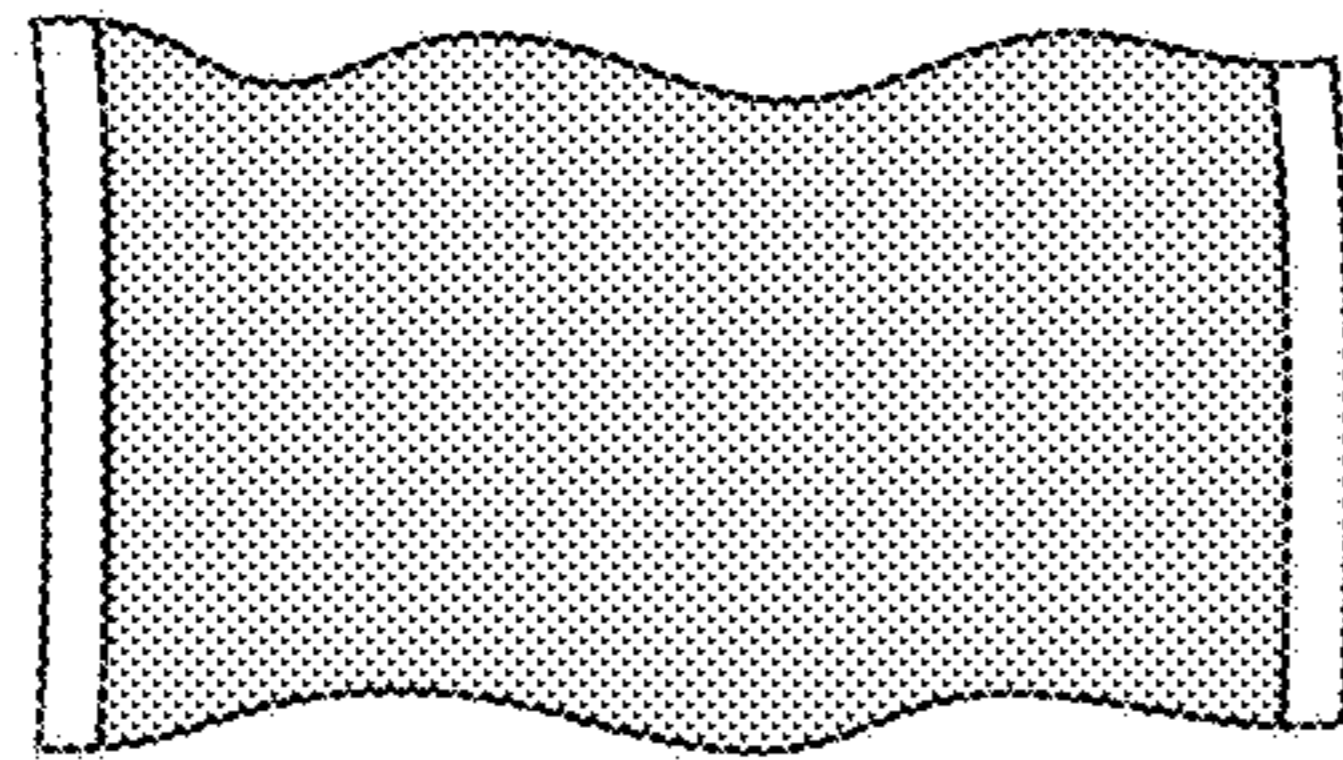

FIG. 186A

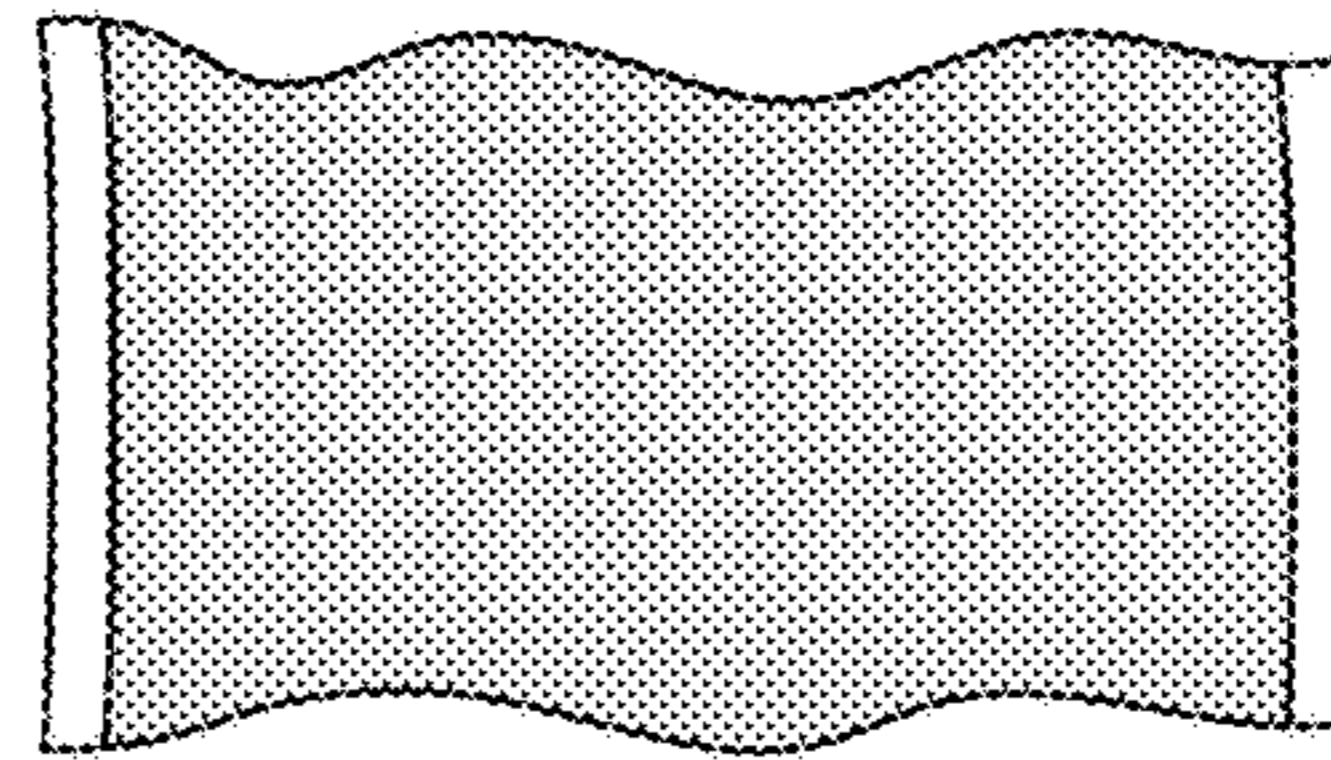

FIG. 186B

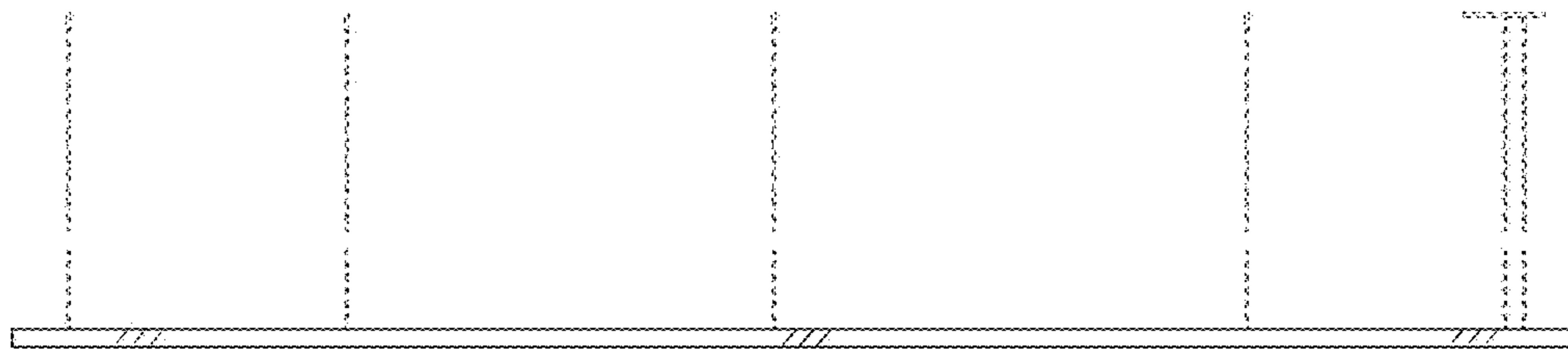

FIG. 187

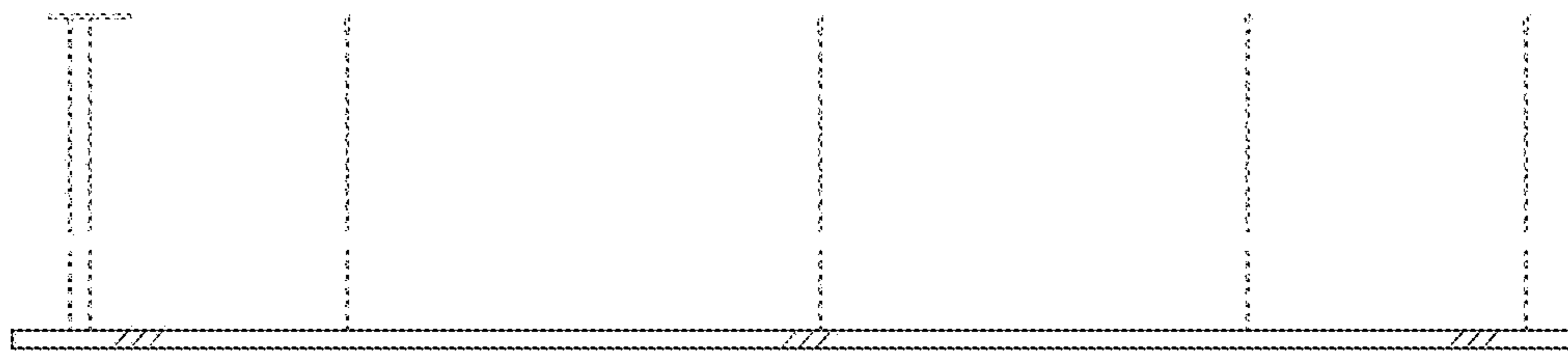

FIG. 188

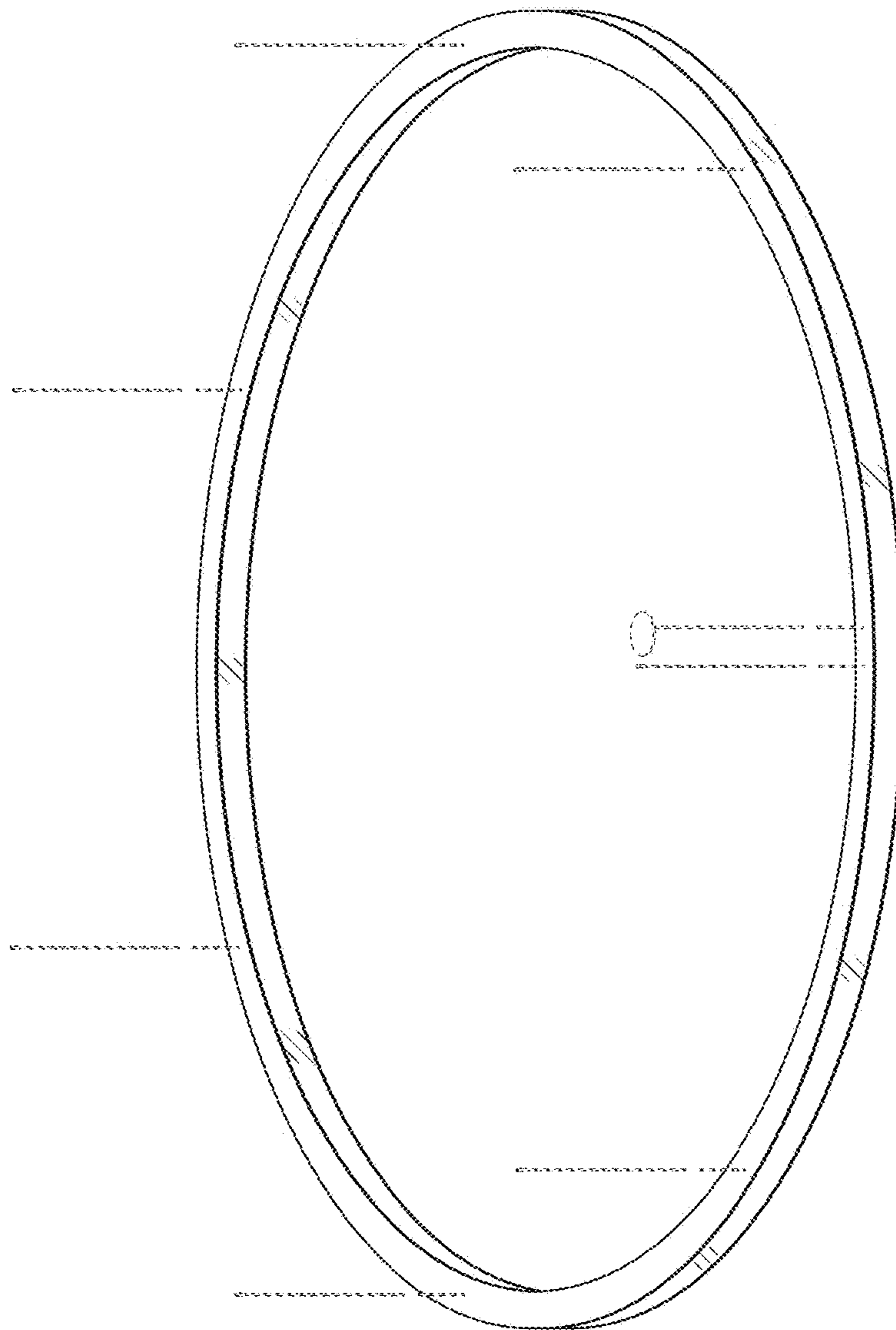

FIG. 189

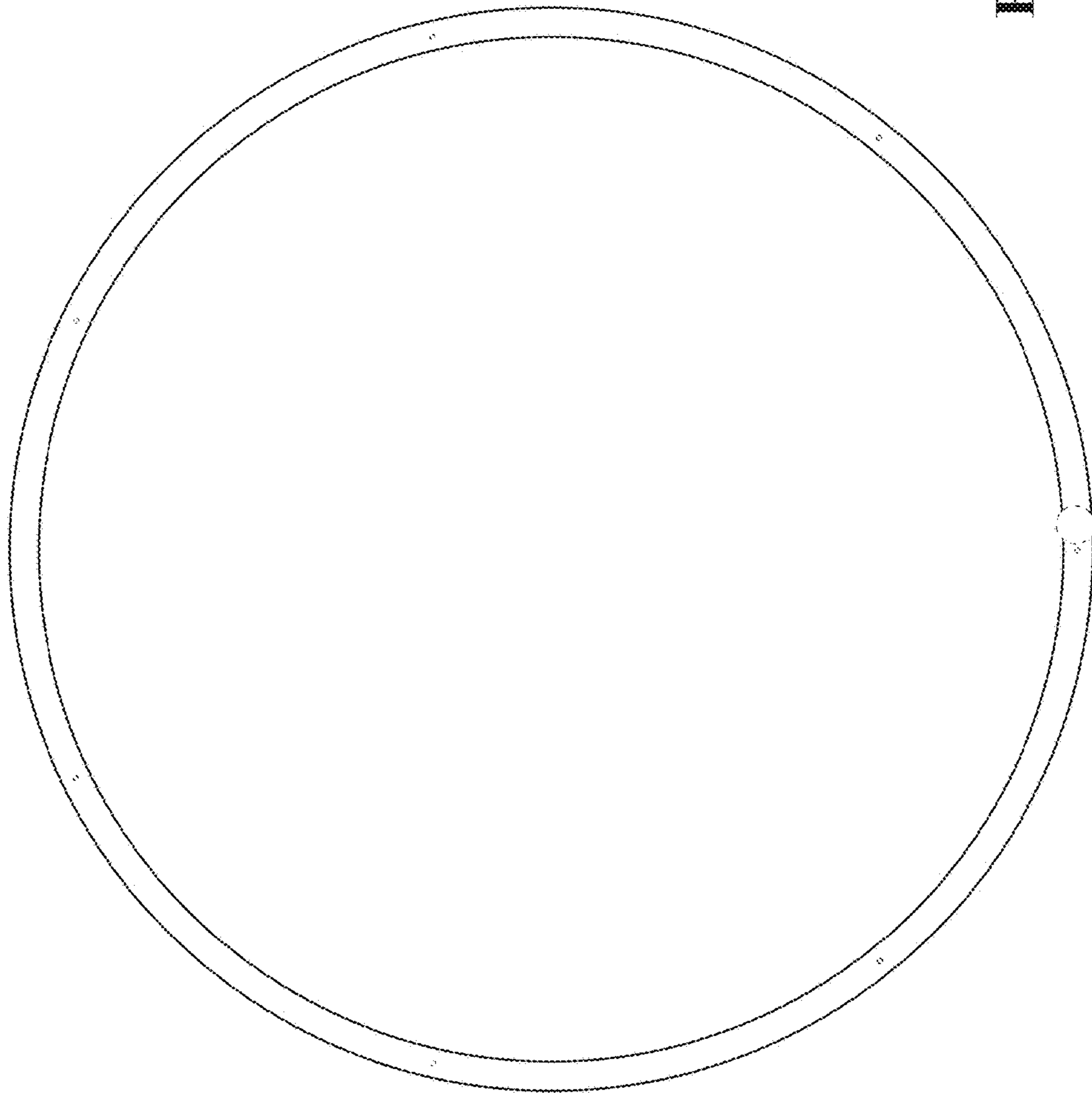

FIG. 190

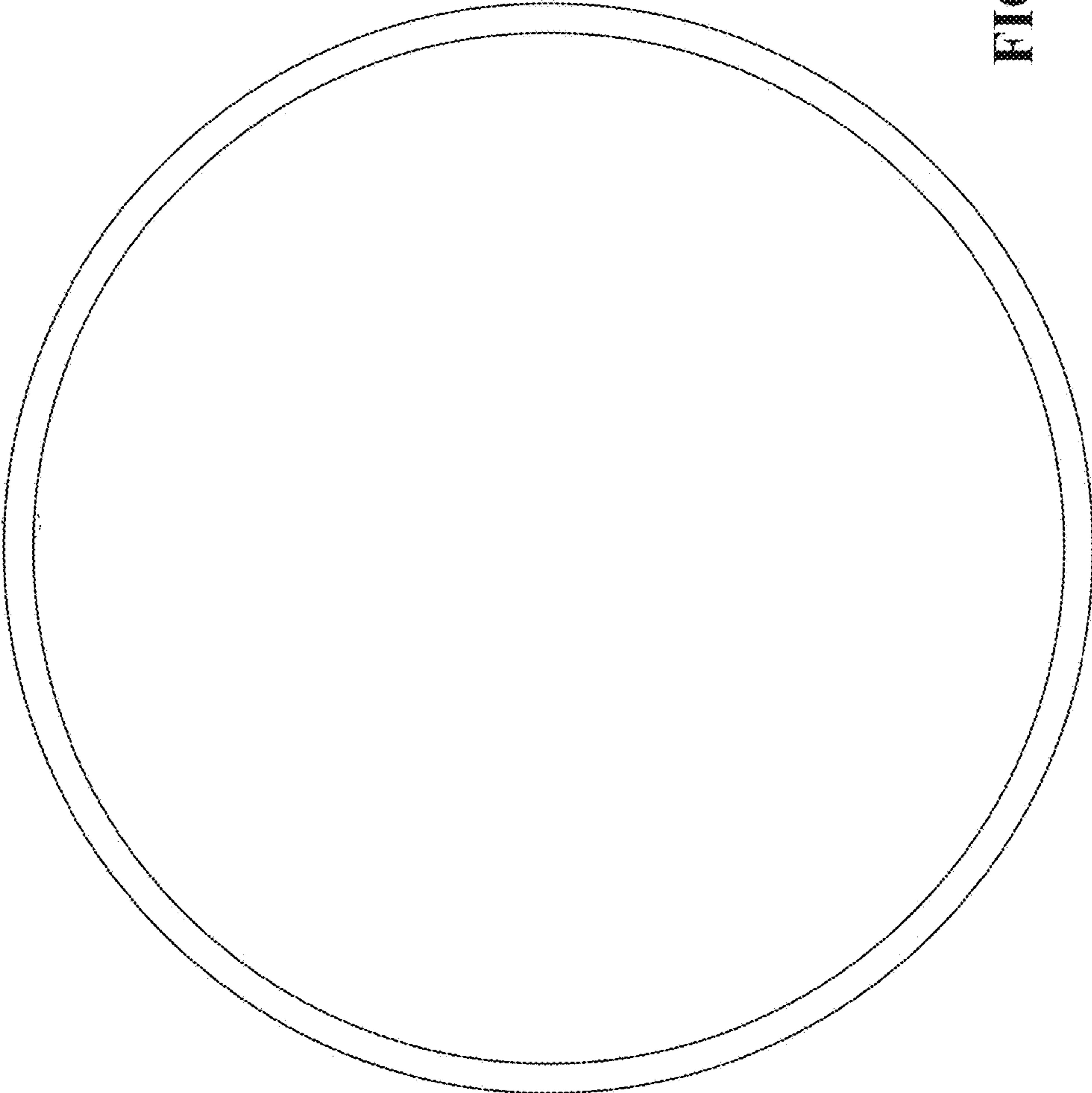

FIG. 191

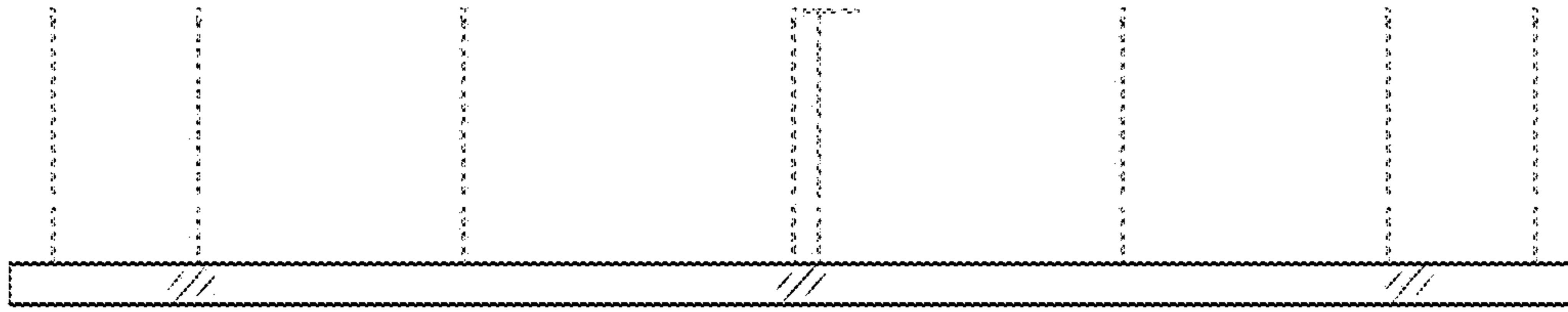

FIG. 192

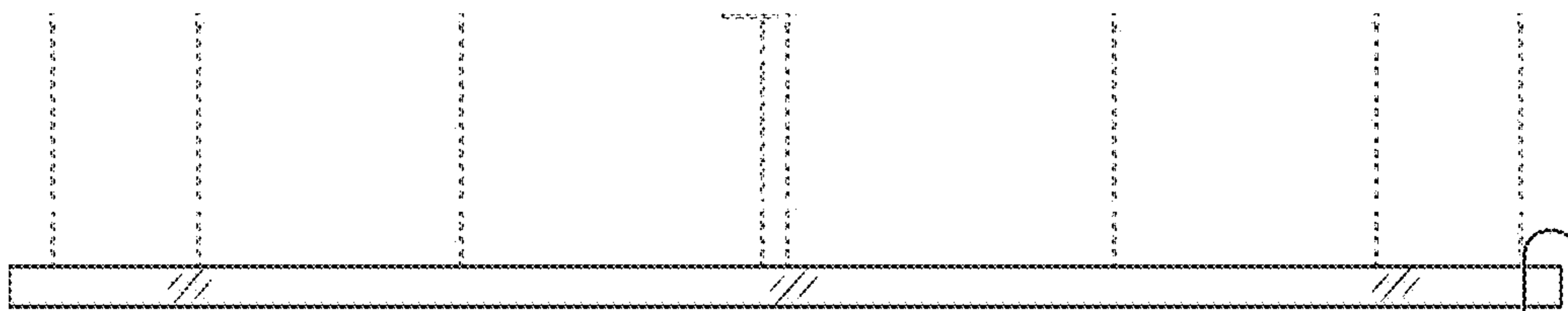

FIG. 193

FIG. 194

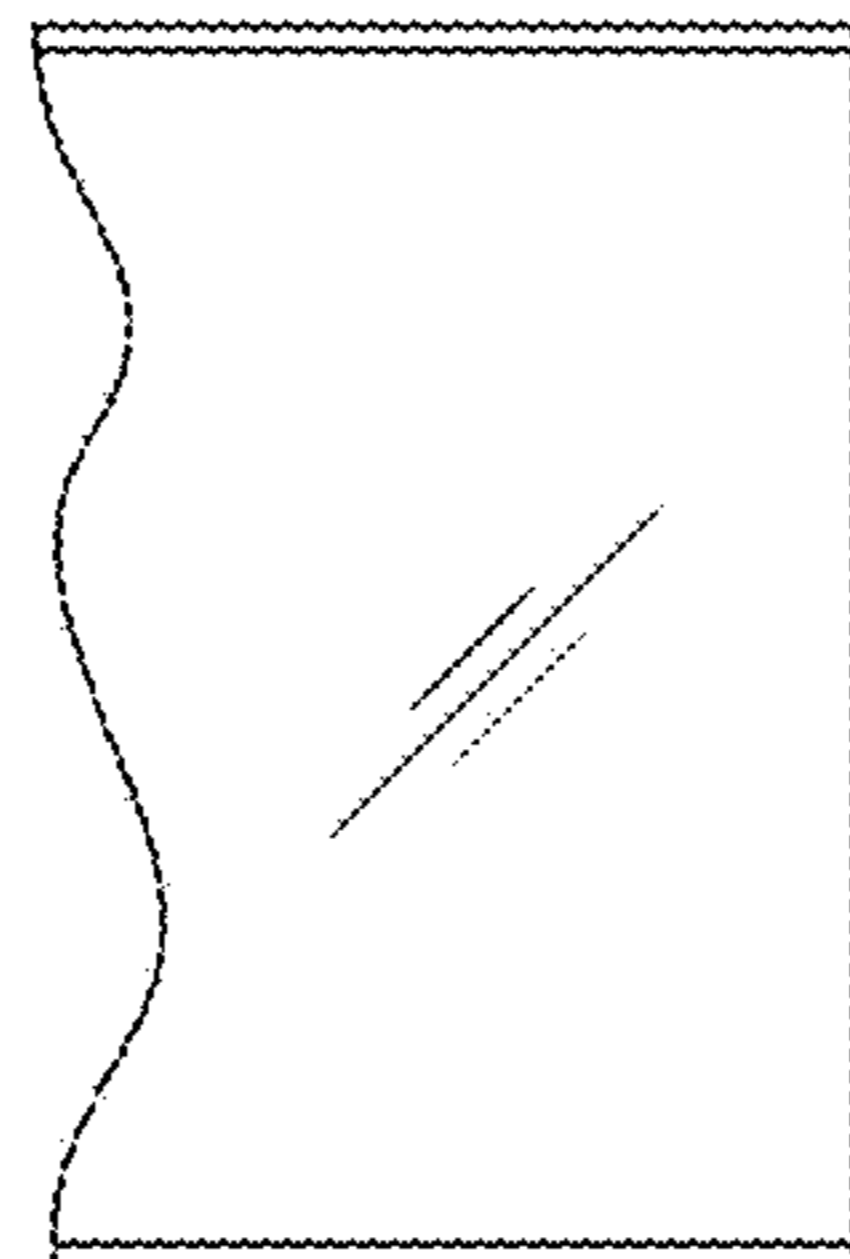

FIG. 194

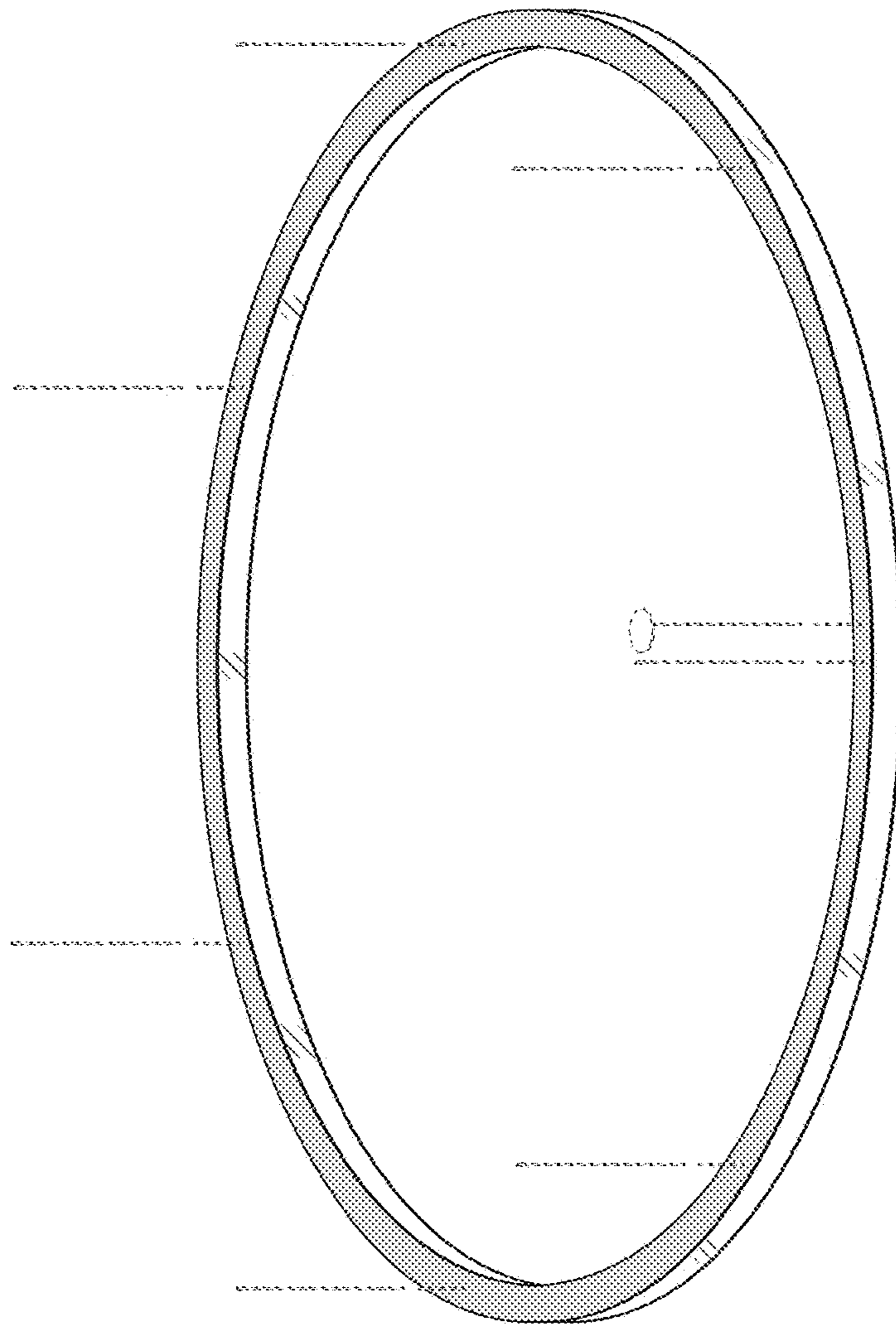

FIG. 195

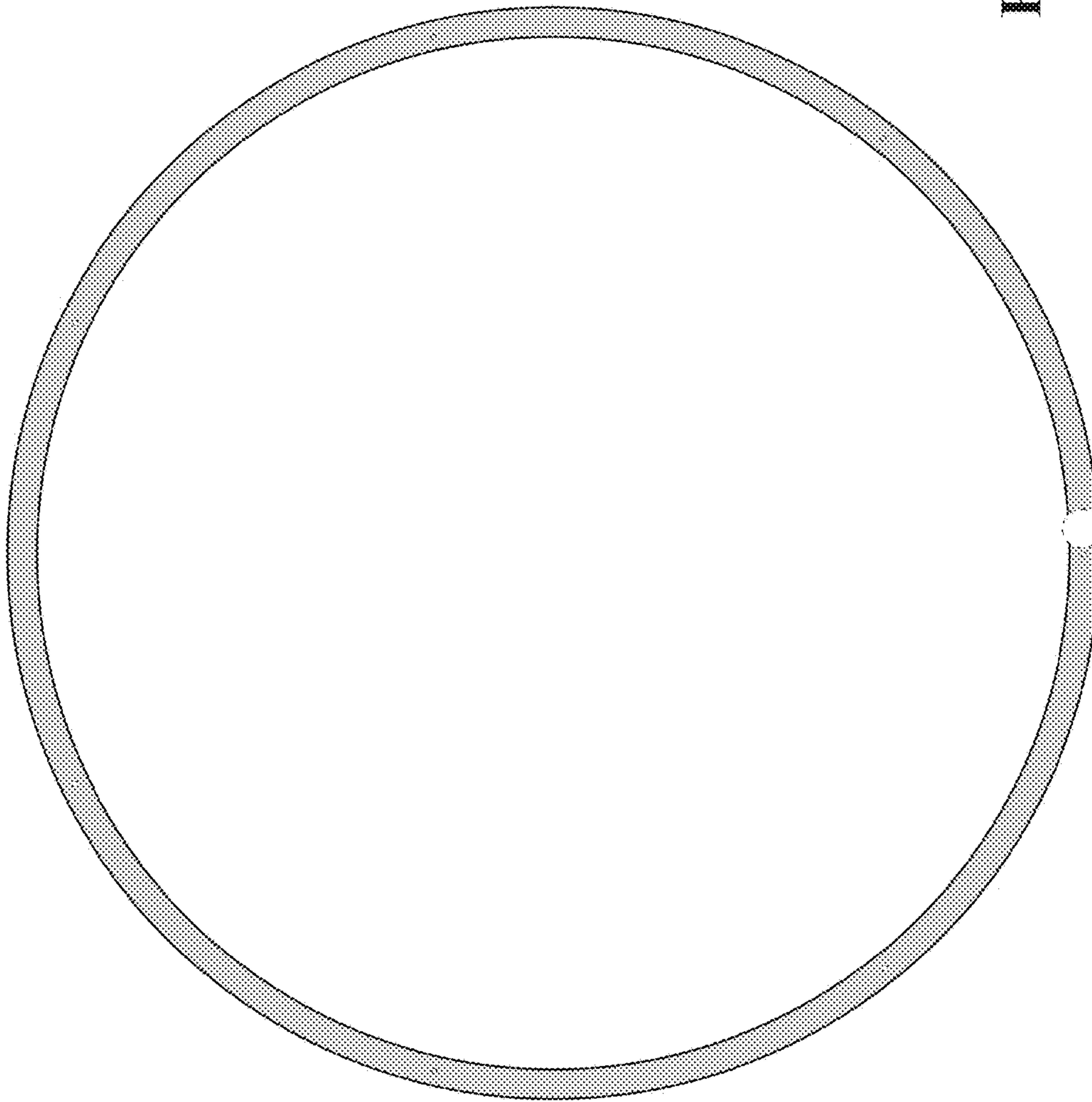

FIG. 196

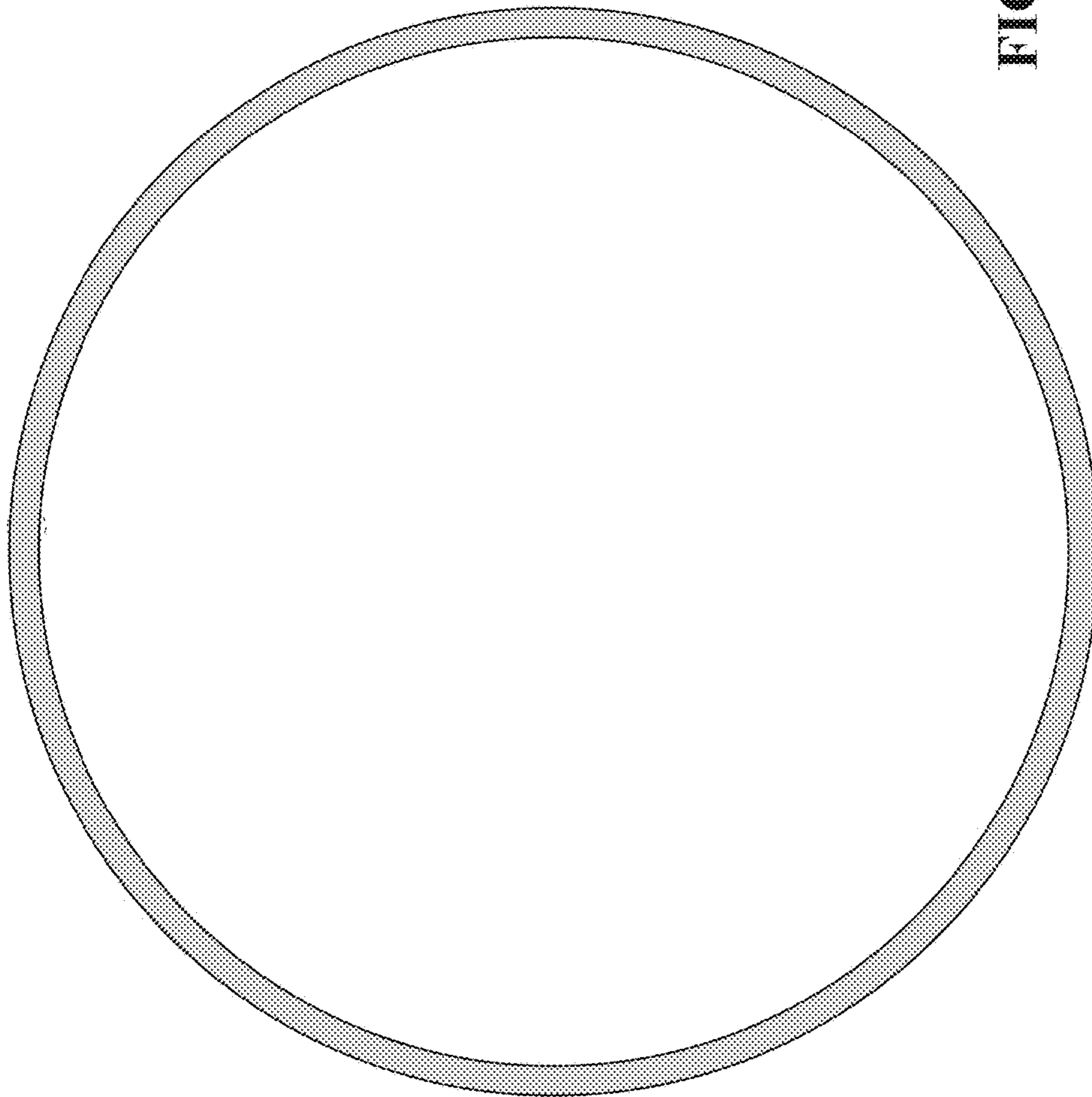

FIG. 197

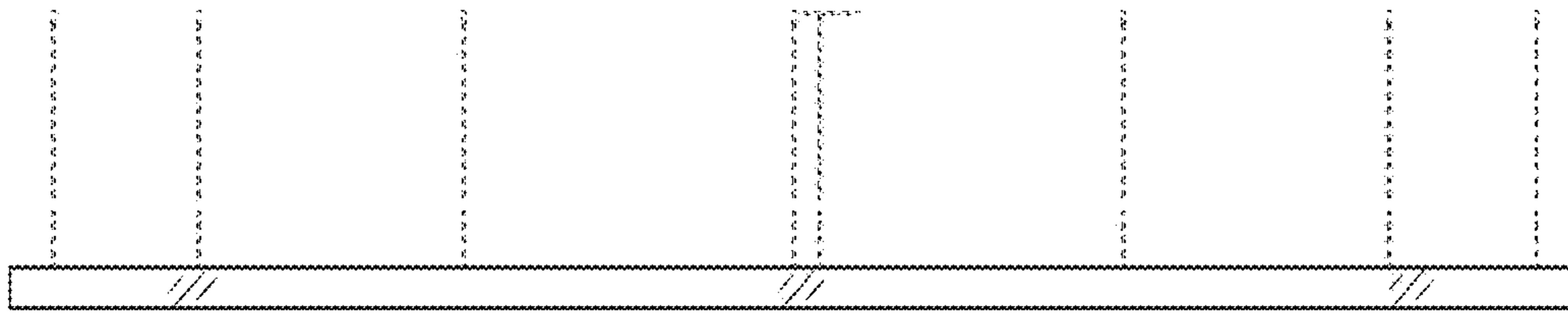

FIG. 198

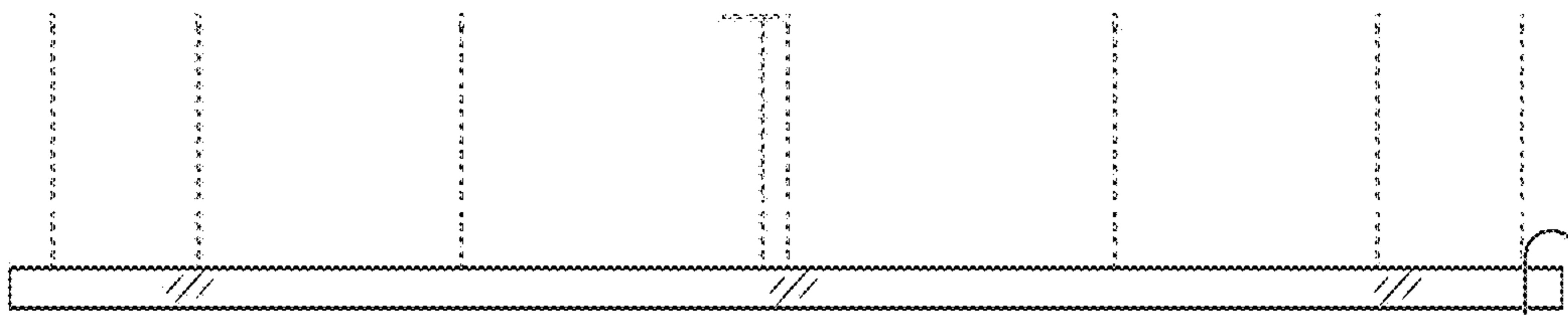

FIG. 199

FIG. 200



FIG. 200

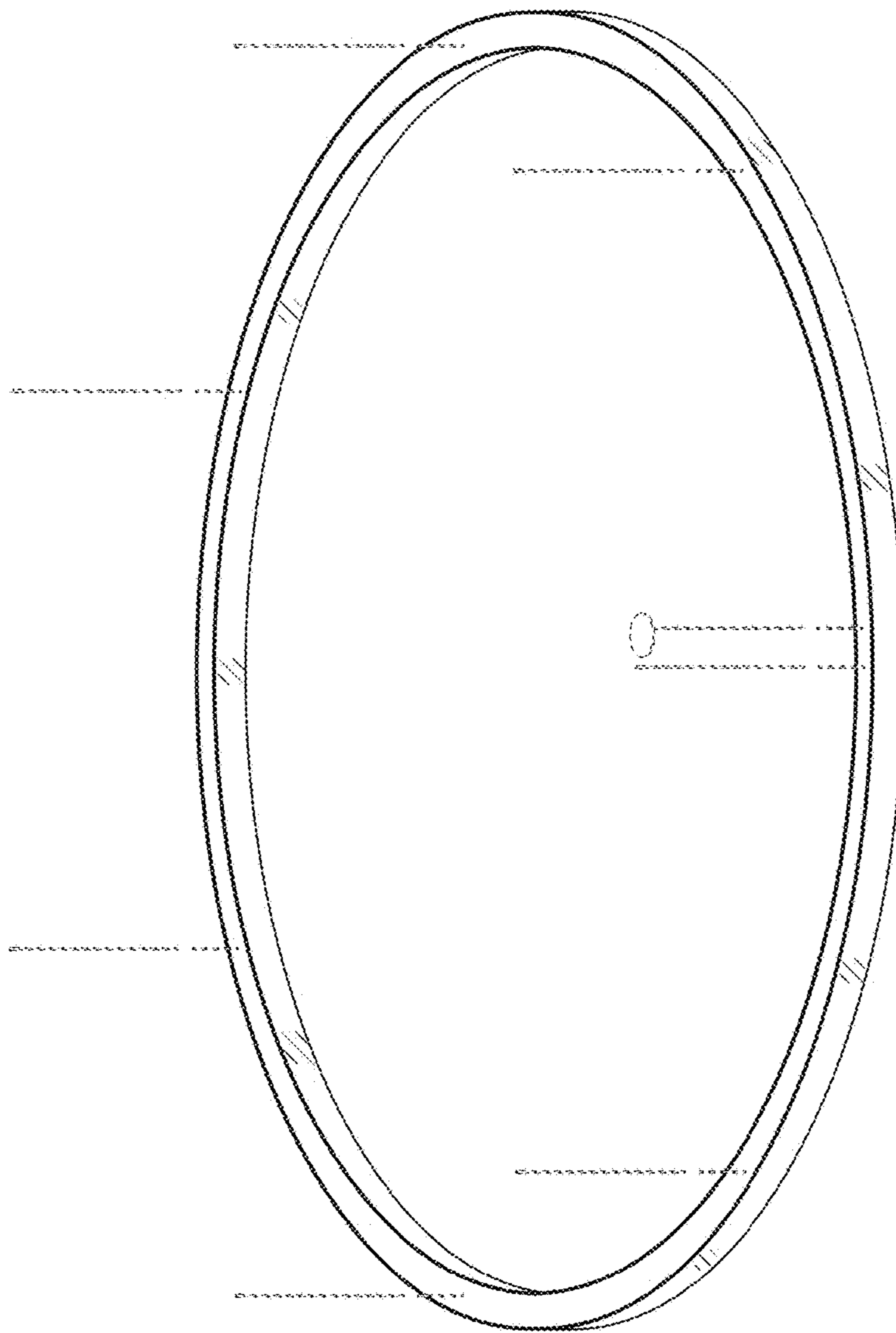

FIG. 201

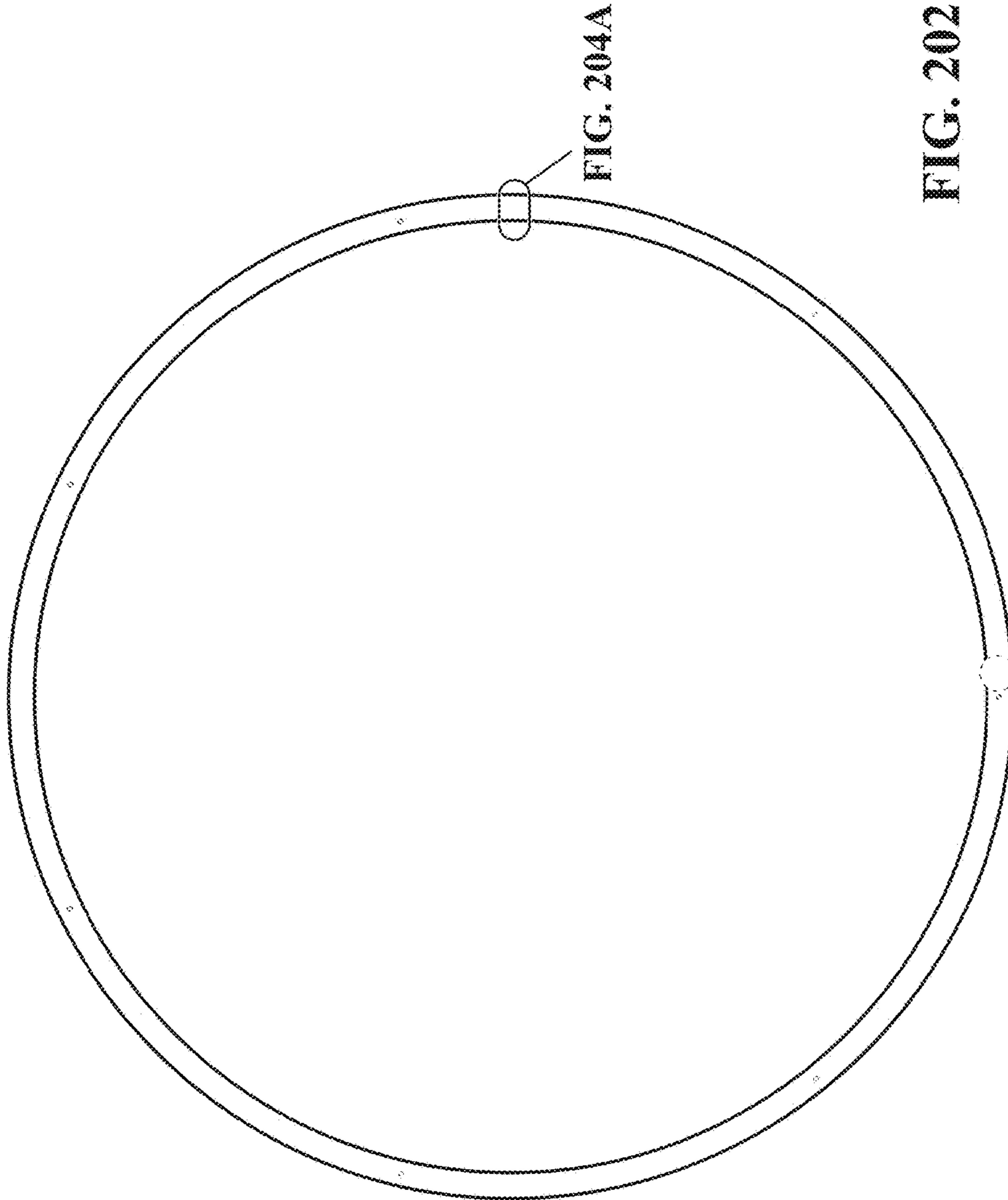

FIG. 204A

FIG. 202

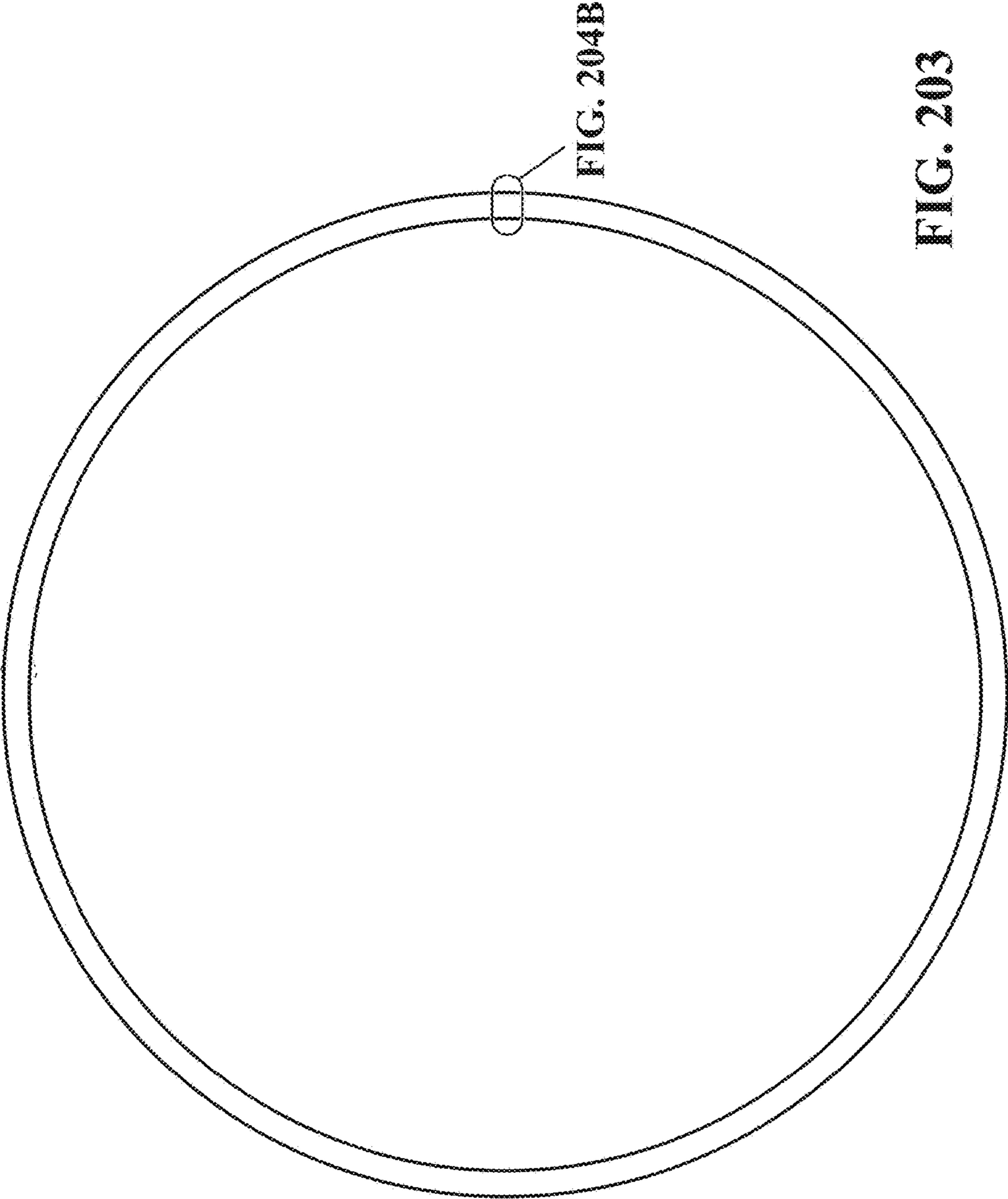

FIG. 203

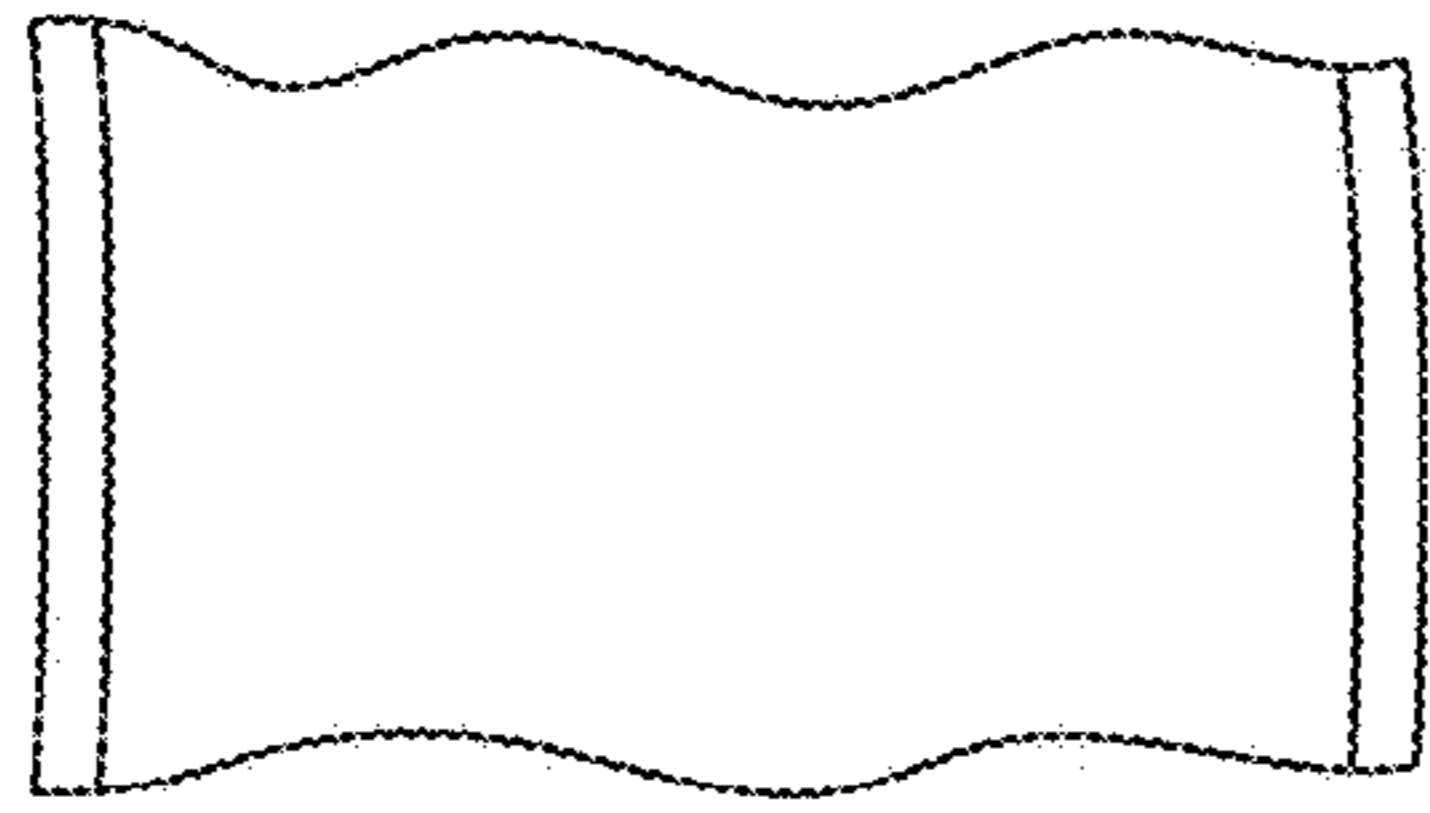

FIG. 204A

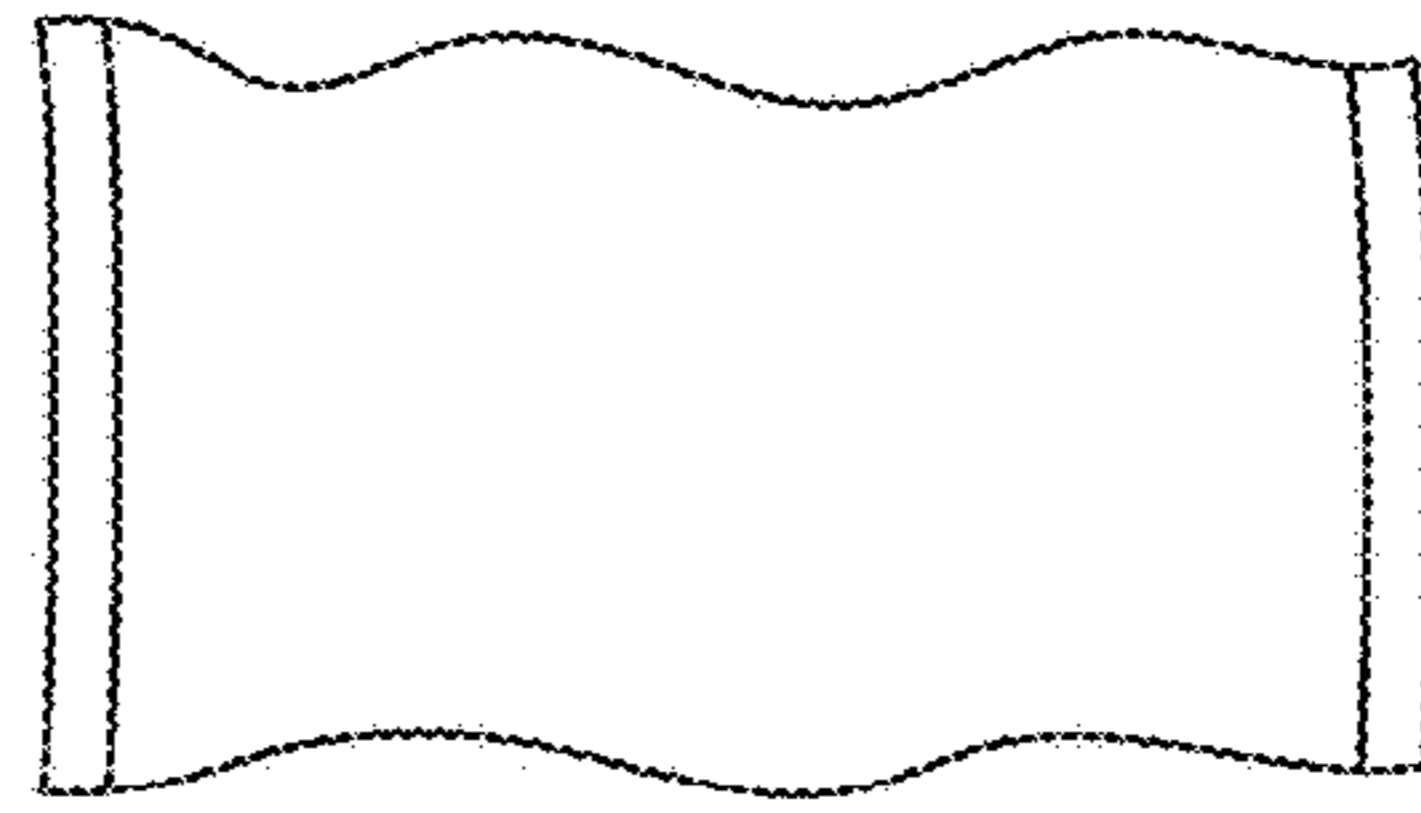

FIG. 204B

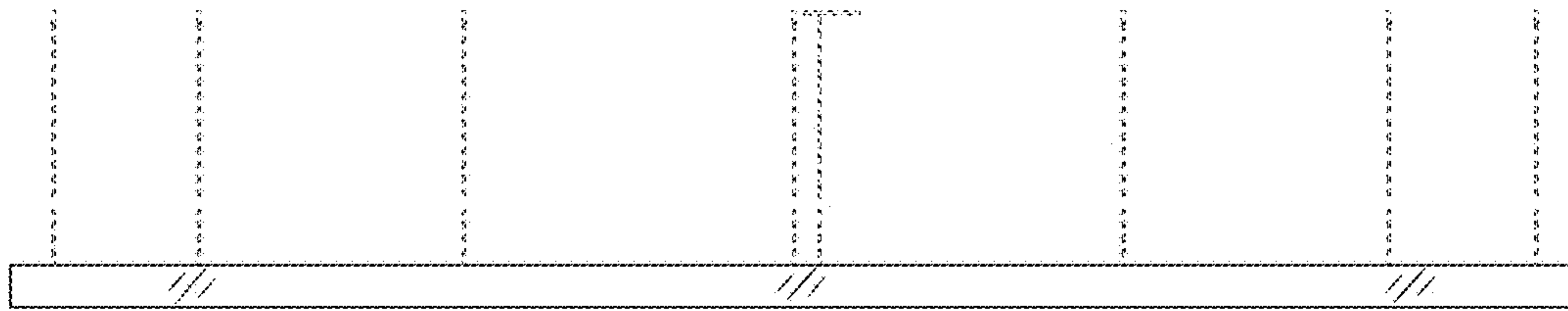

FIG. 205

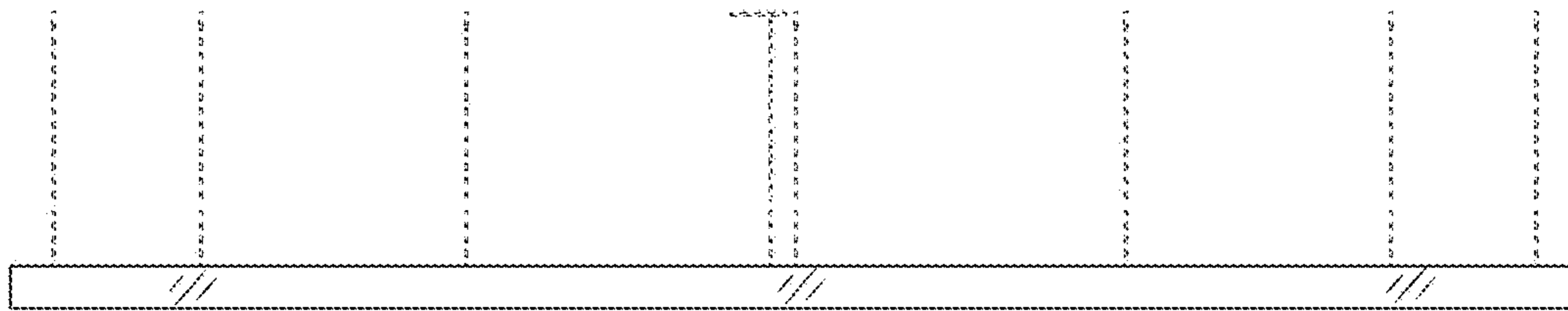

FIG. 206

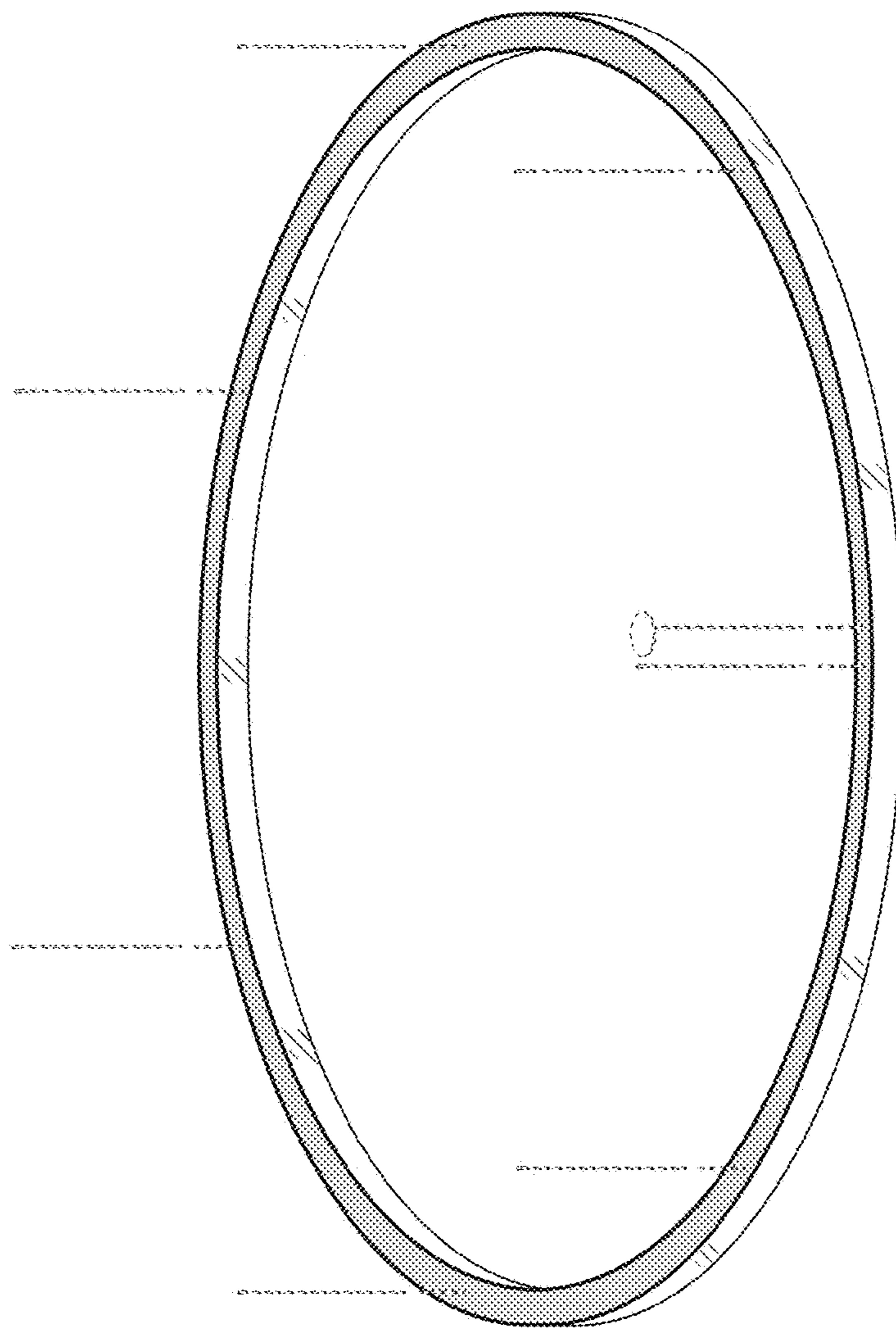

FIG. 207

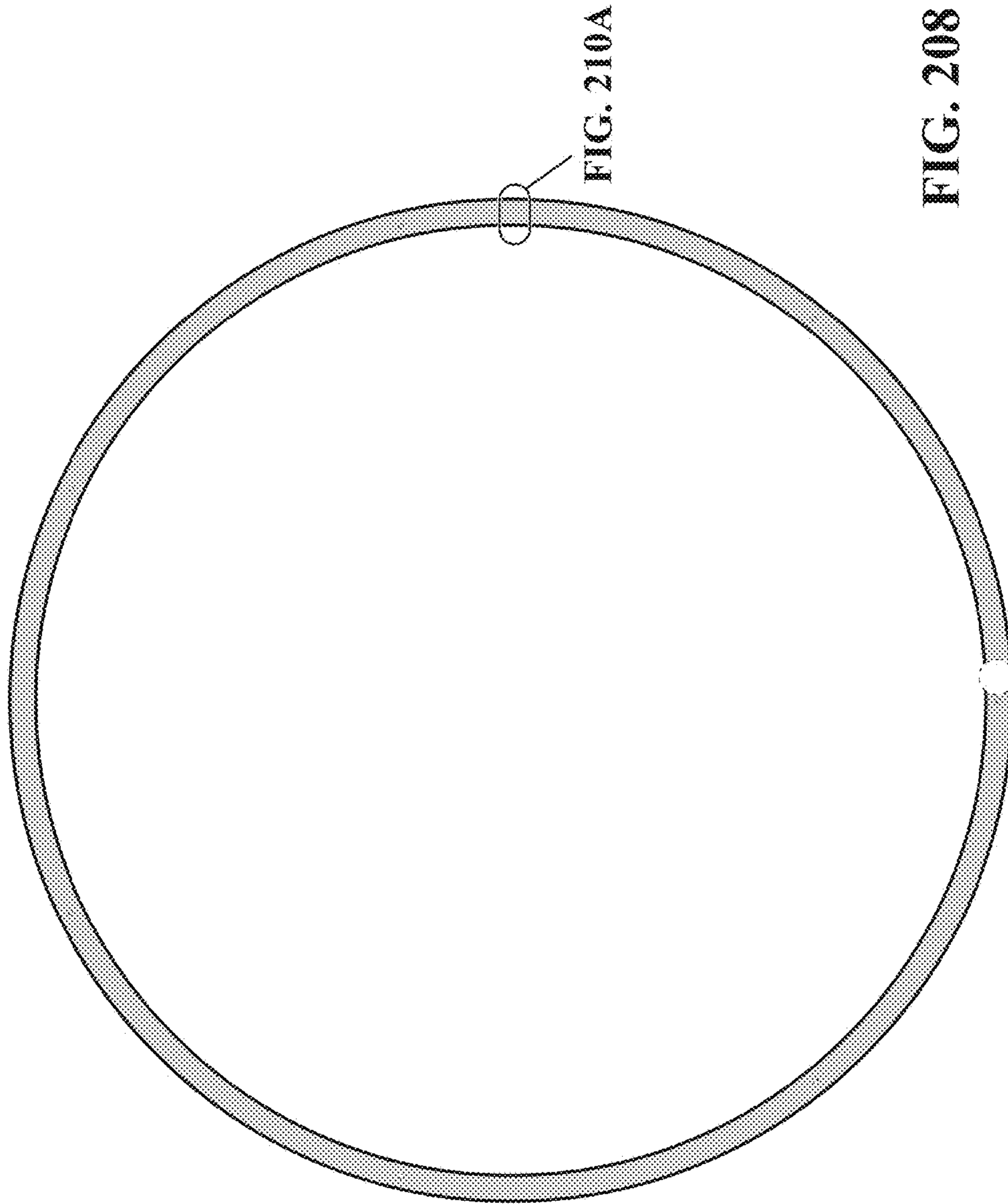

FIG. 210A

FIG. 208

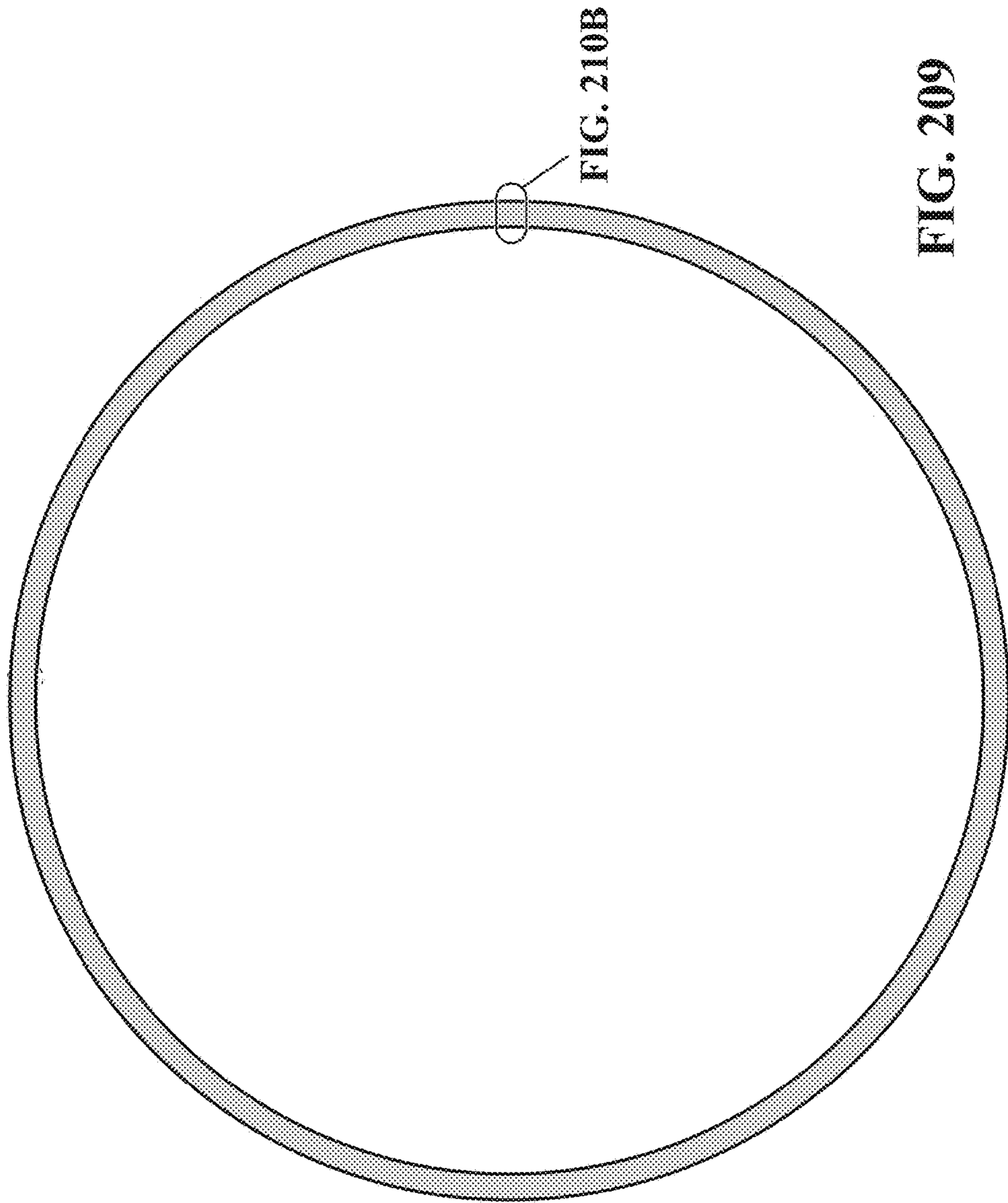

FIG. 210B

FIG. 209

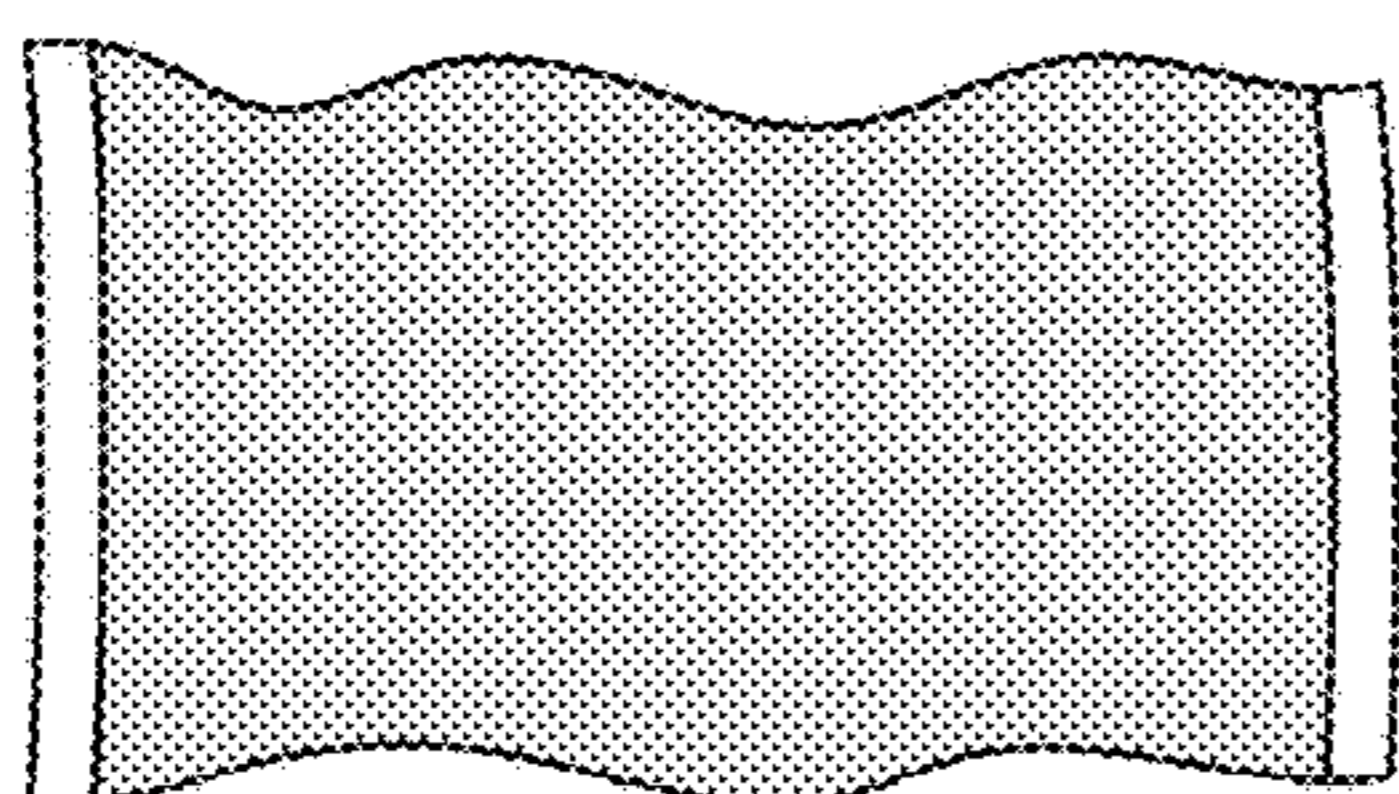

FIG. 210A

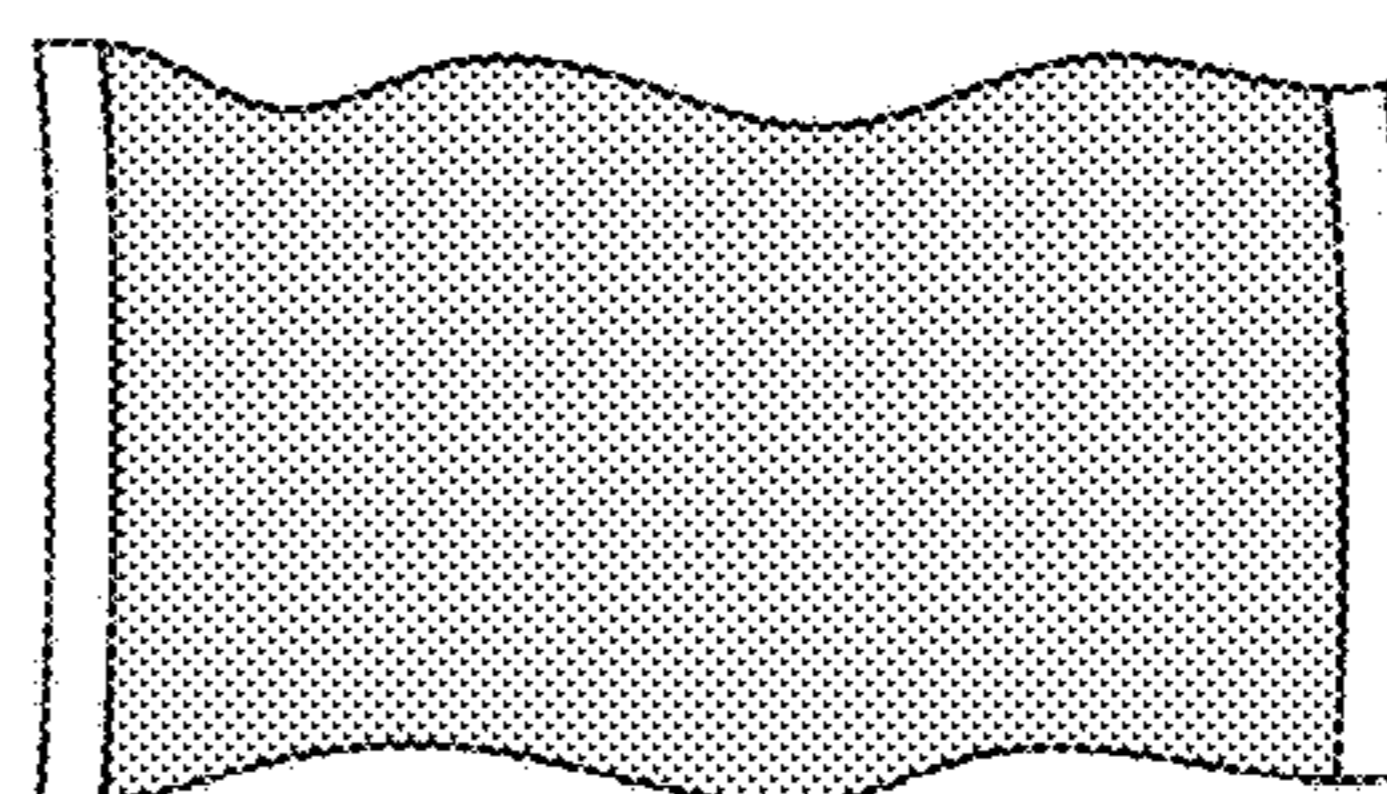

FIG. 210B

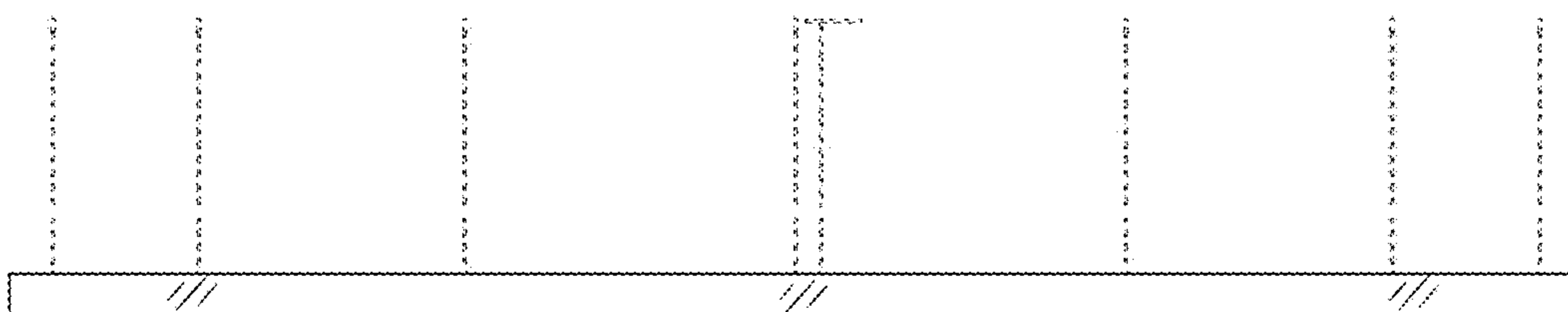

FIG. 211

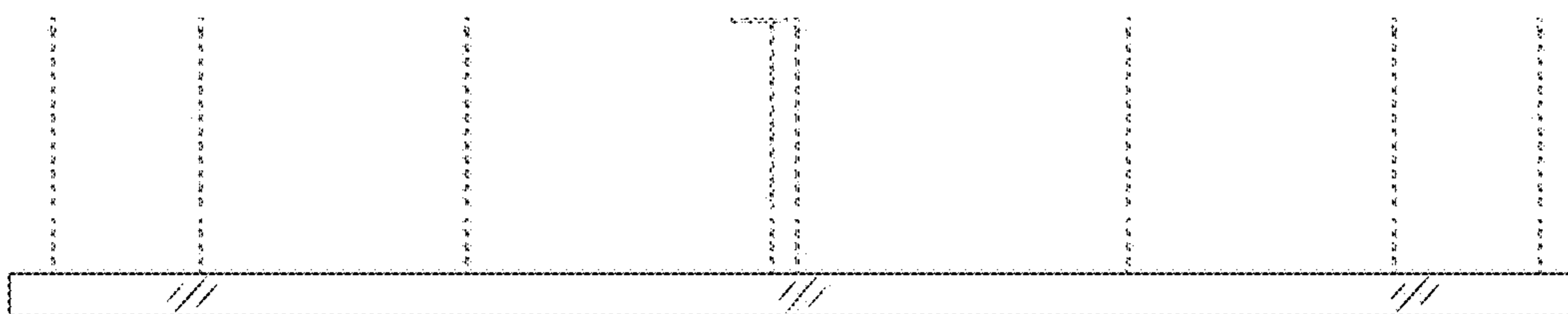

FIG. 212

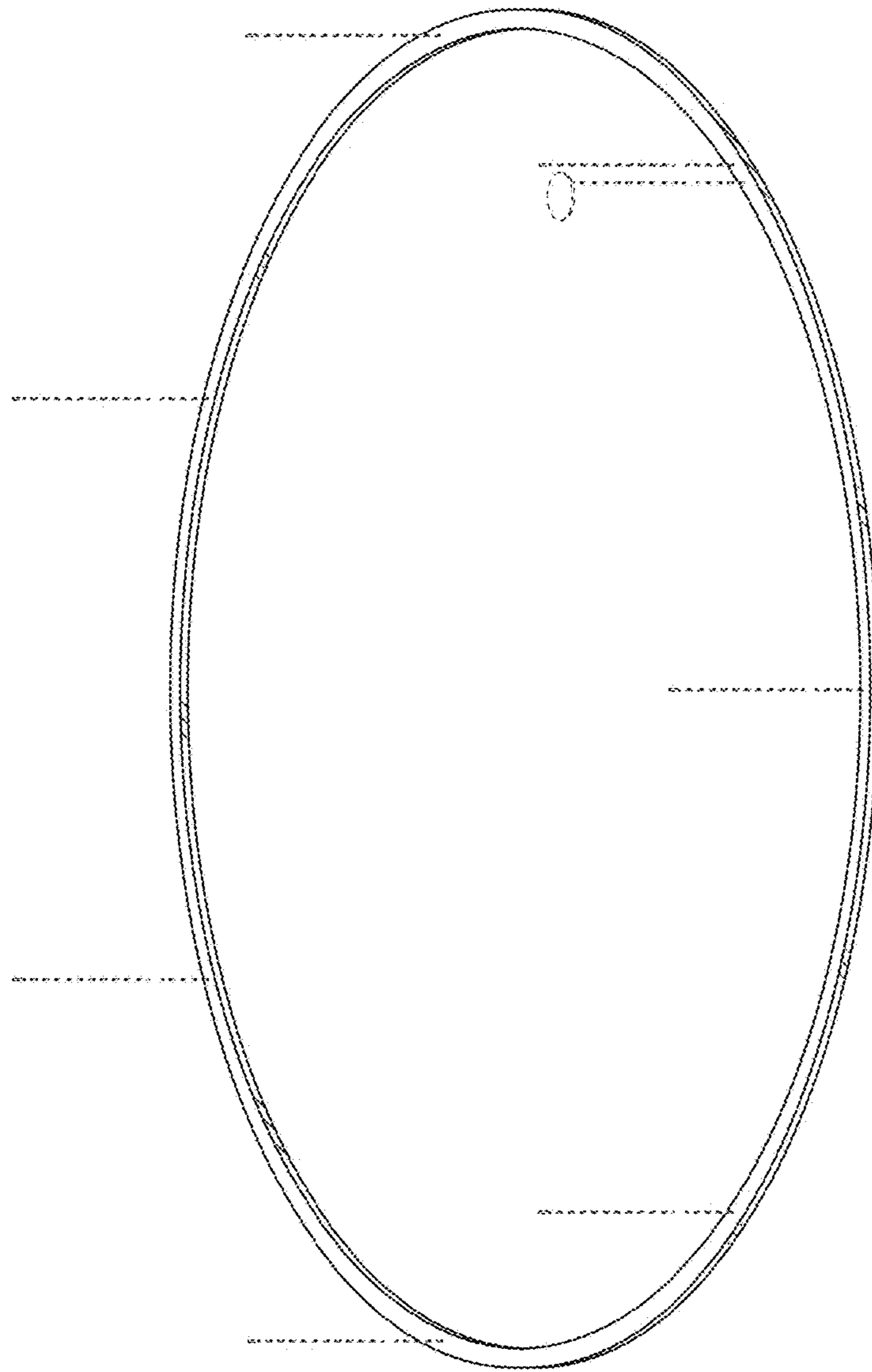

FIG. 213

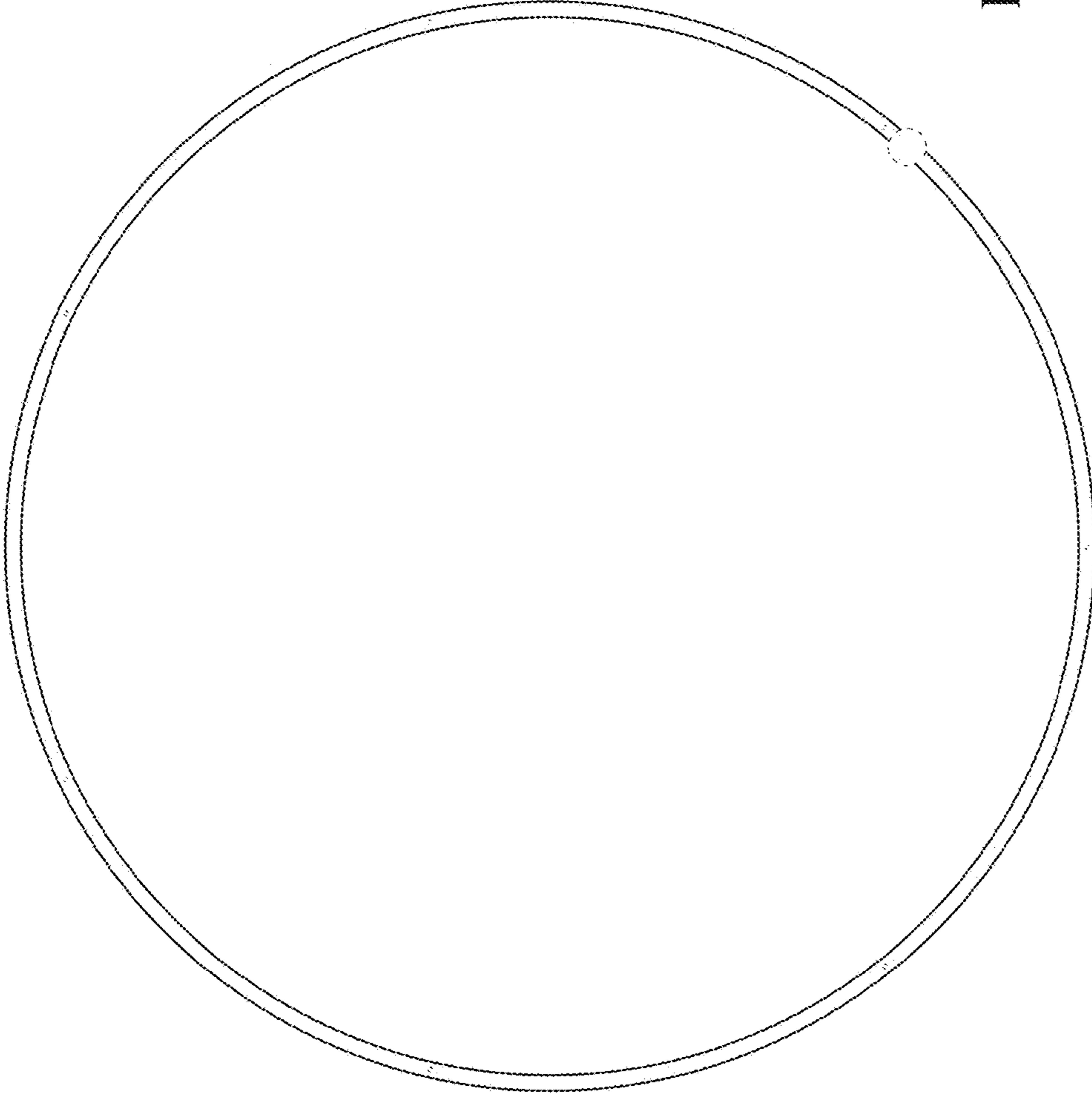

FIG. 214

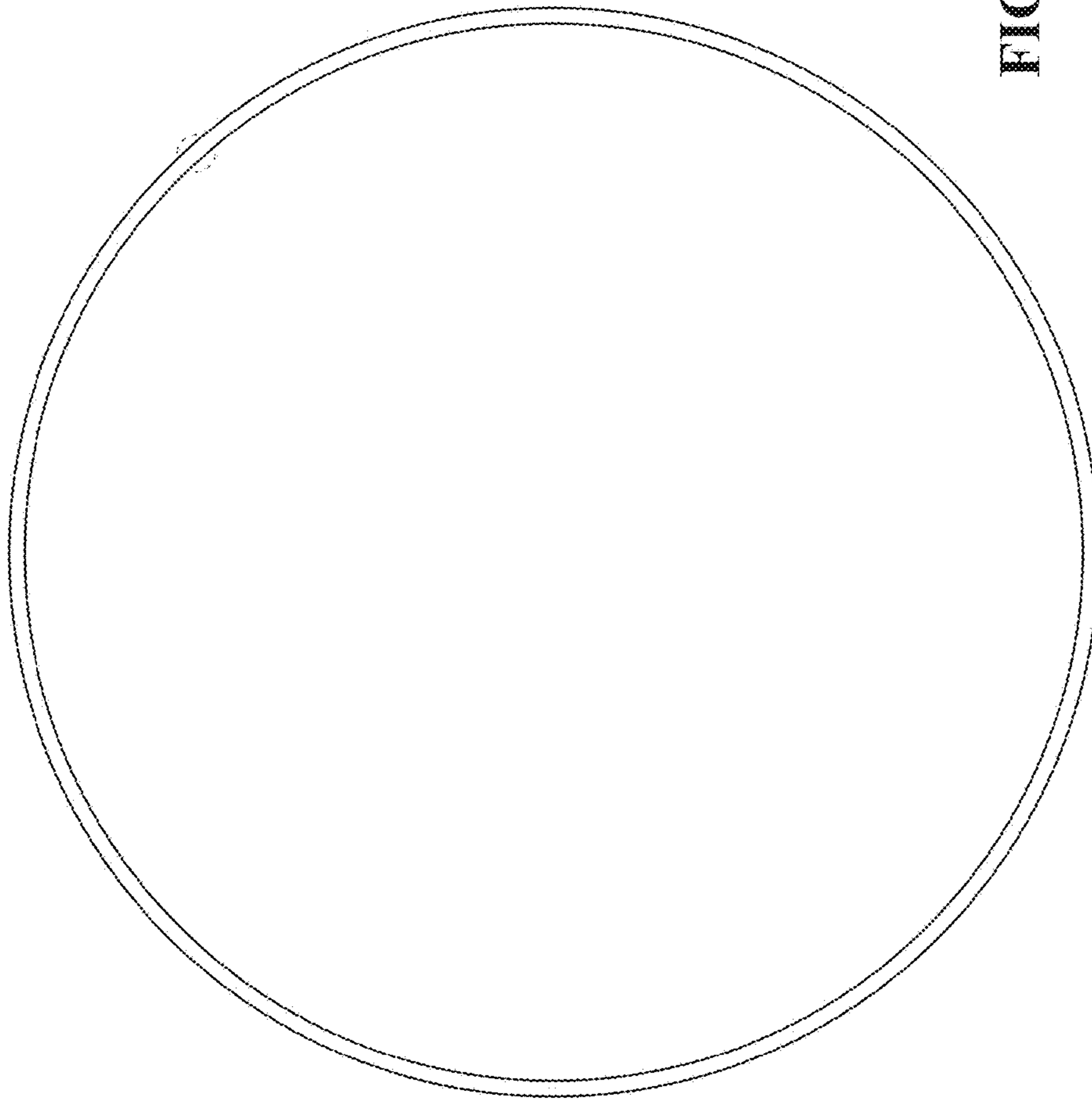

FIG. 215

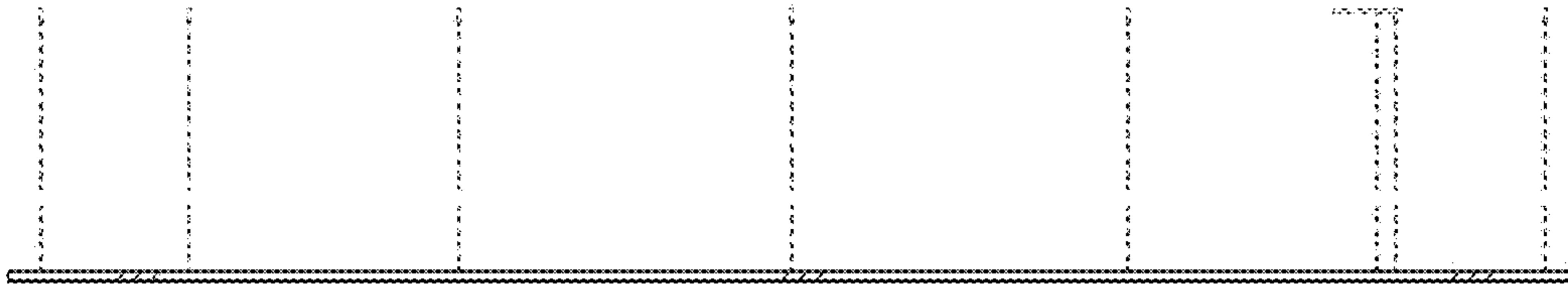

FIG. 216

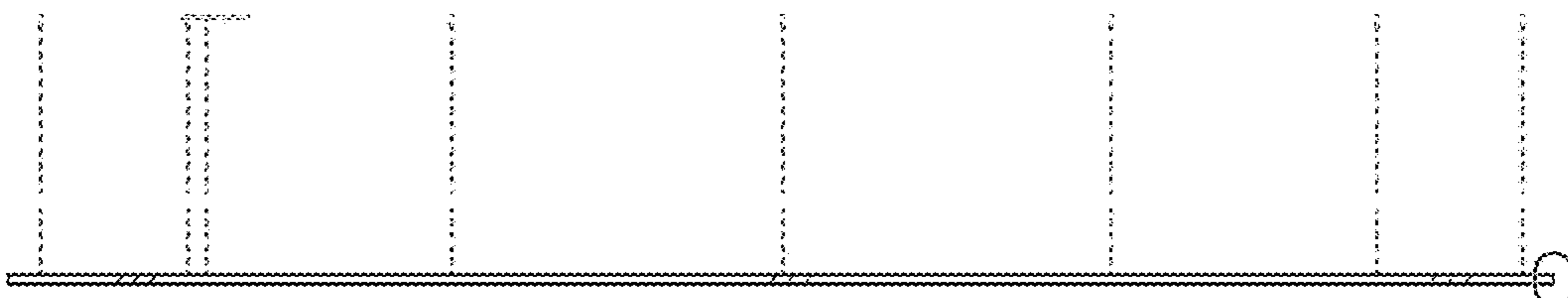

FIG. 217

FIG. 218

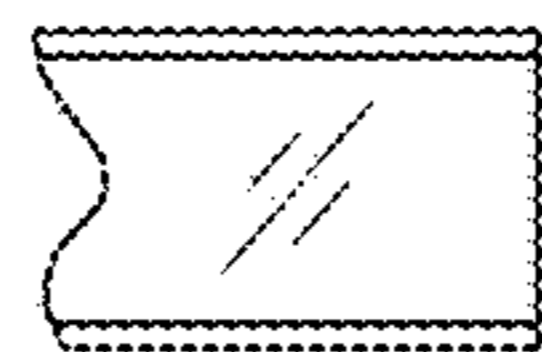

FIG. 218

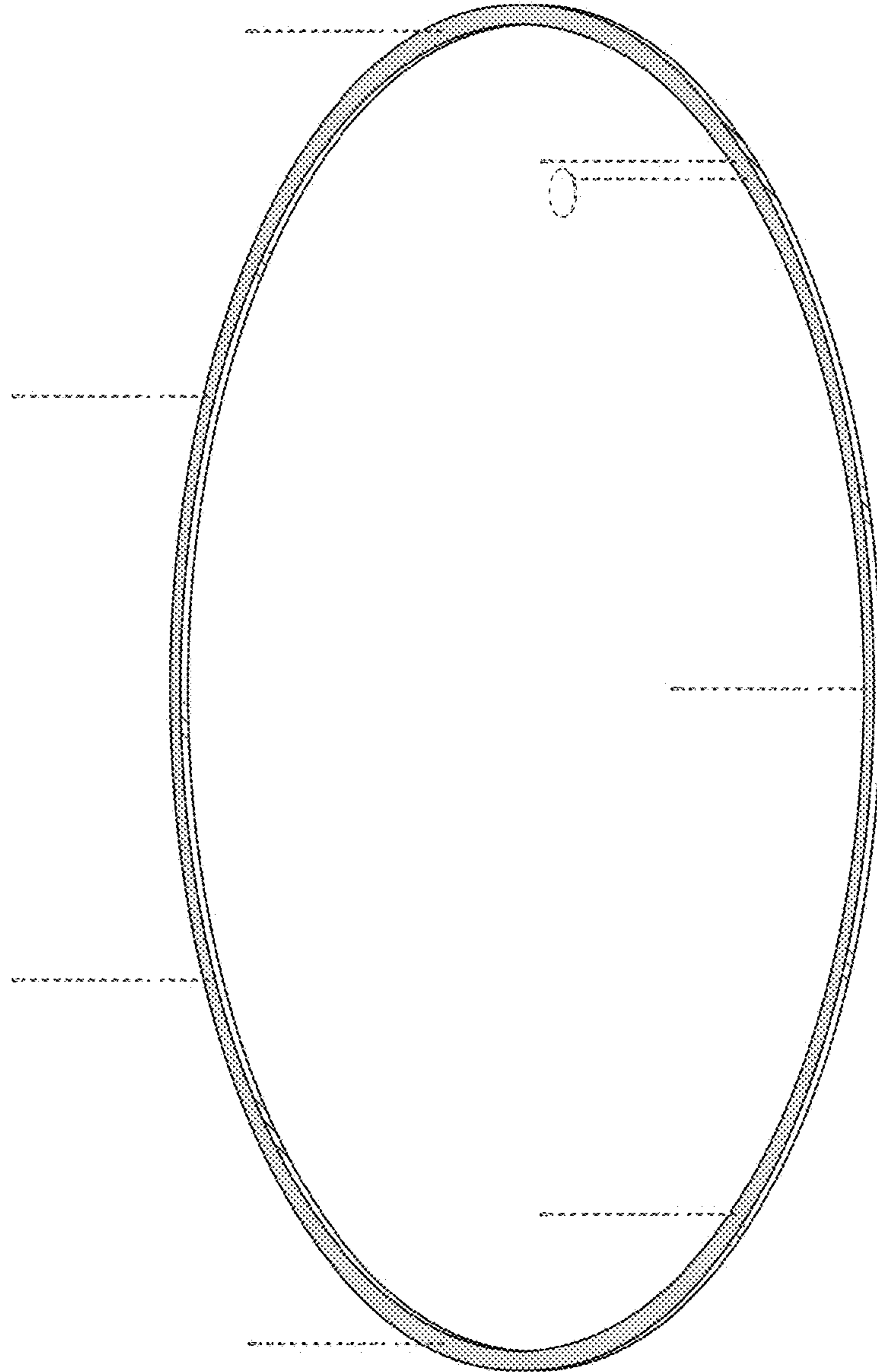

FIG. 219

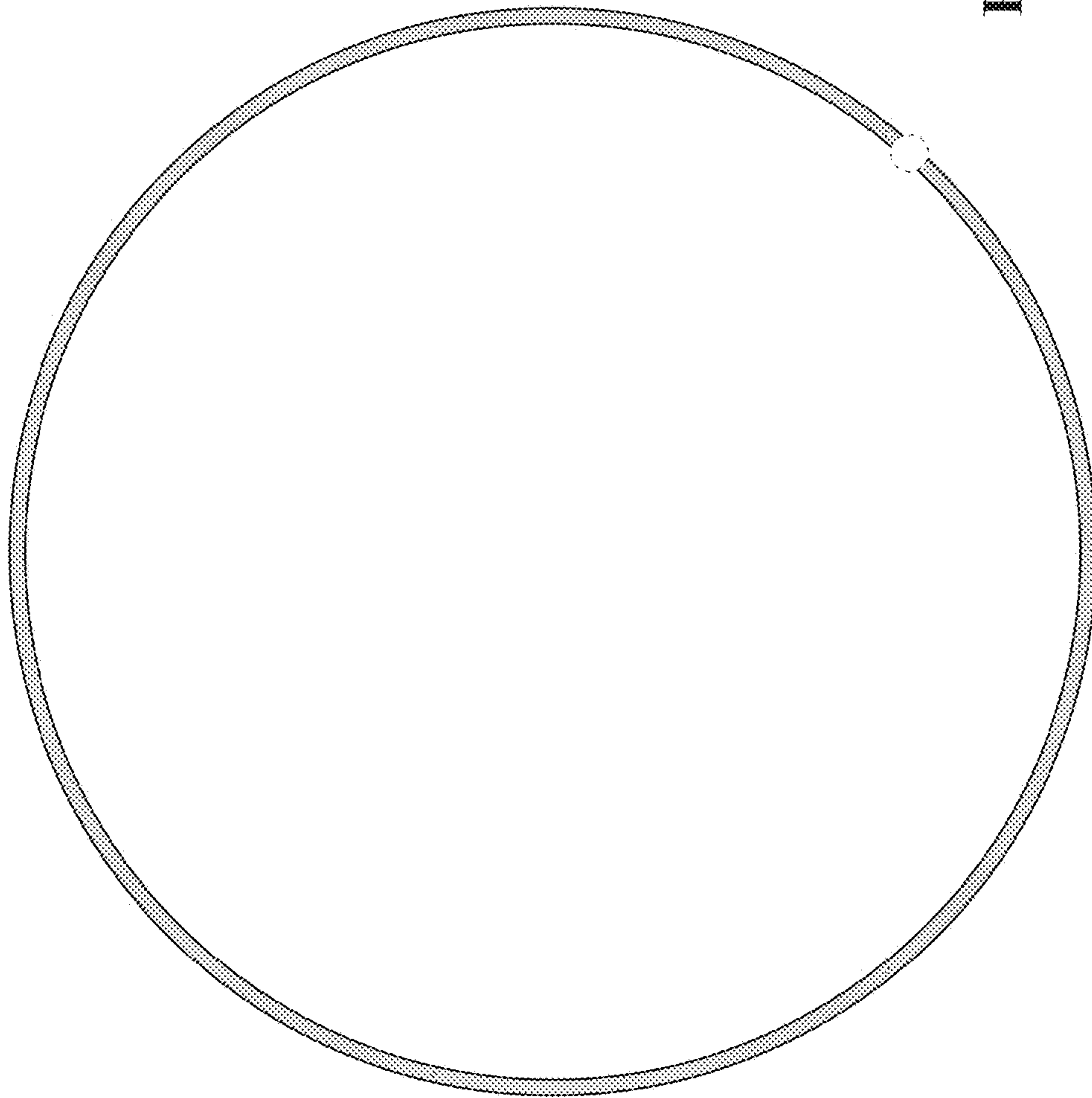

FIG. 220

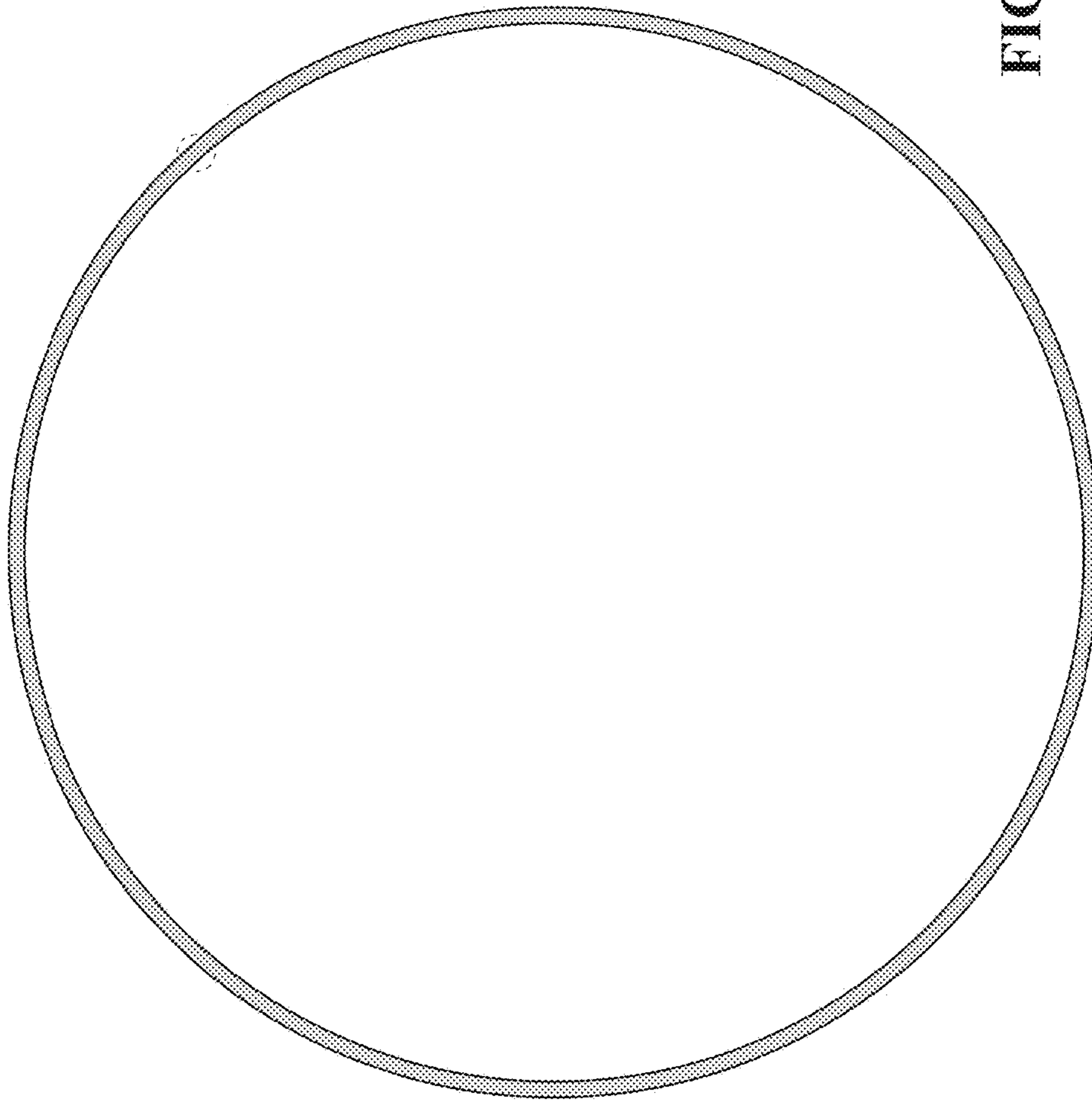

FIG. 221

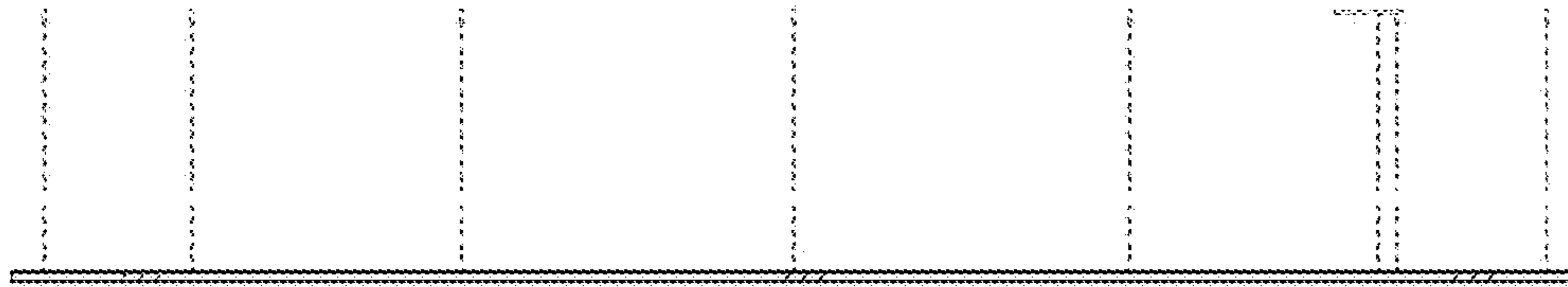

FIG. 222

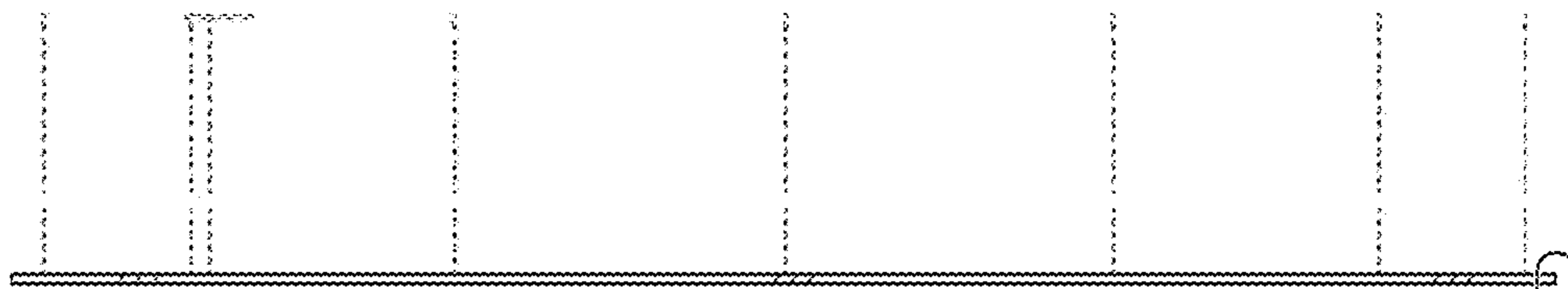

FIG. 223

FIG. 224

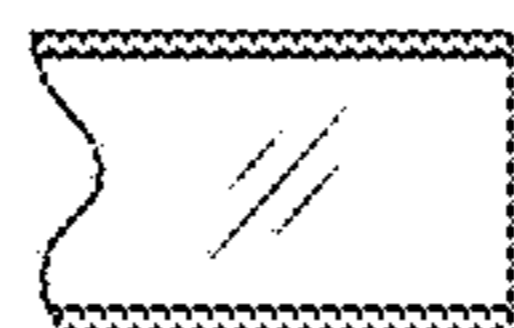

FIG. 224

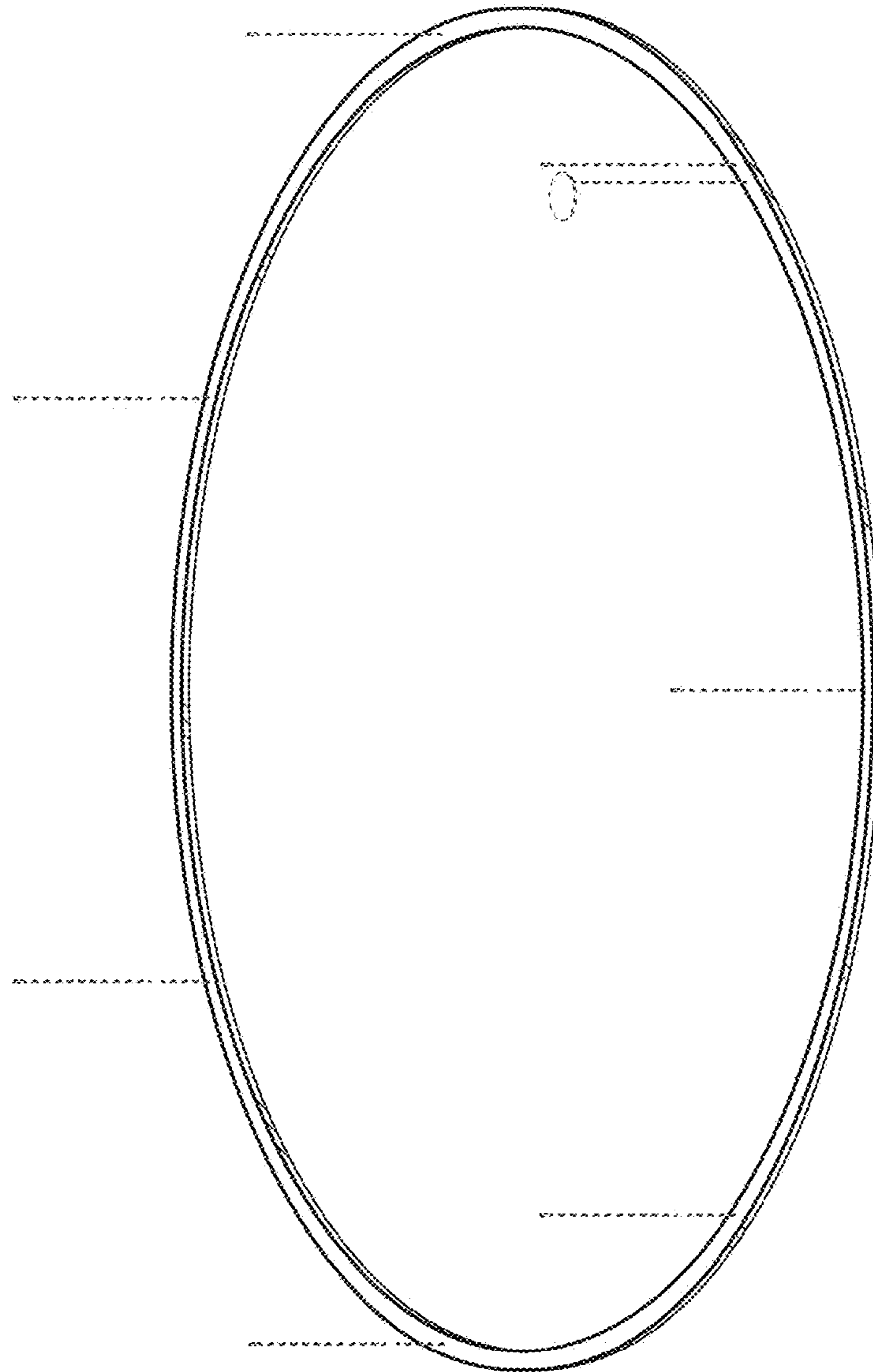
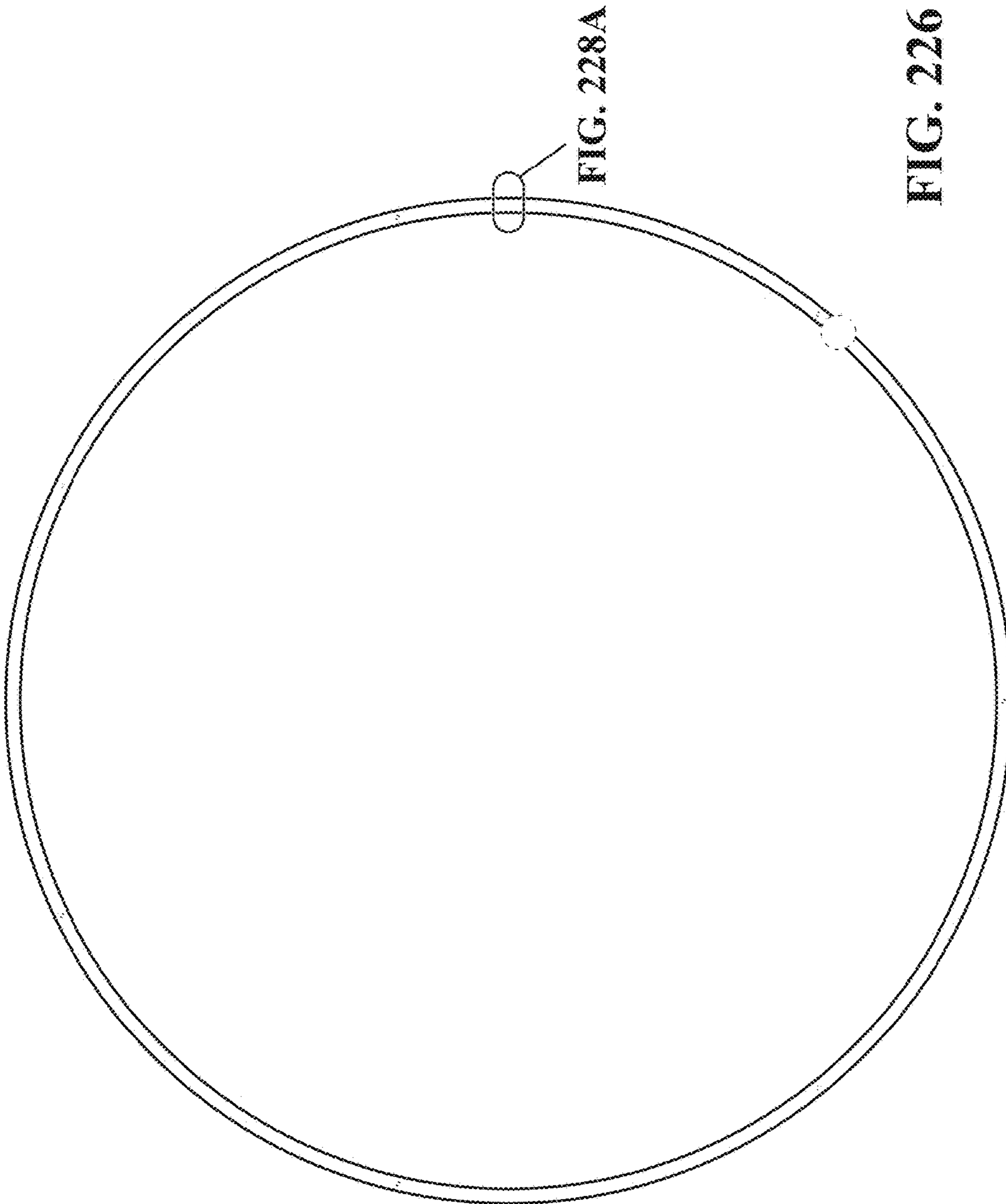

FIG. 225



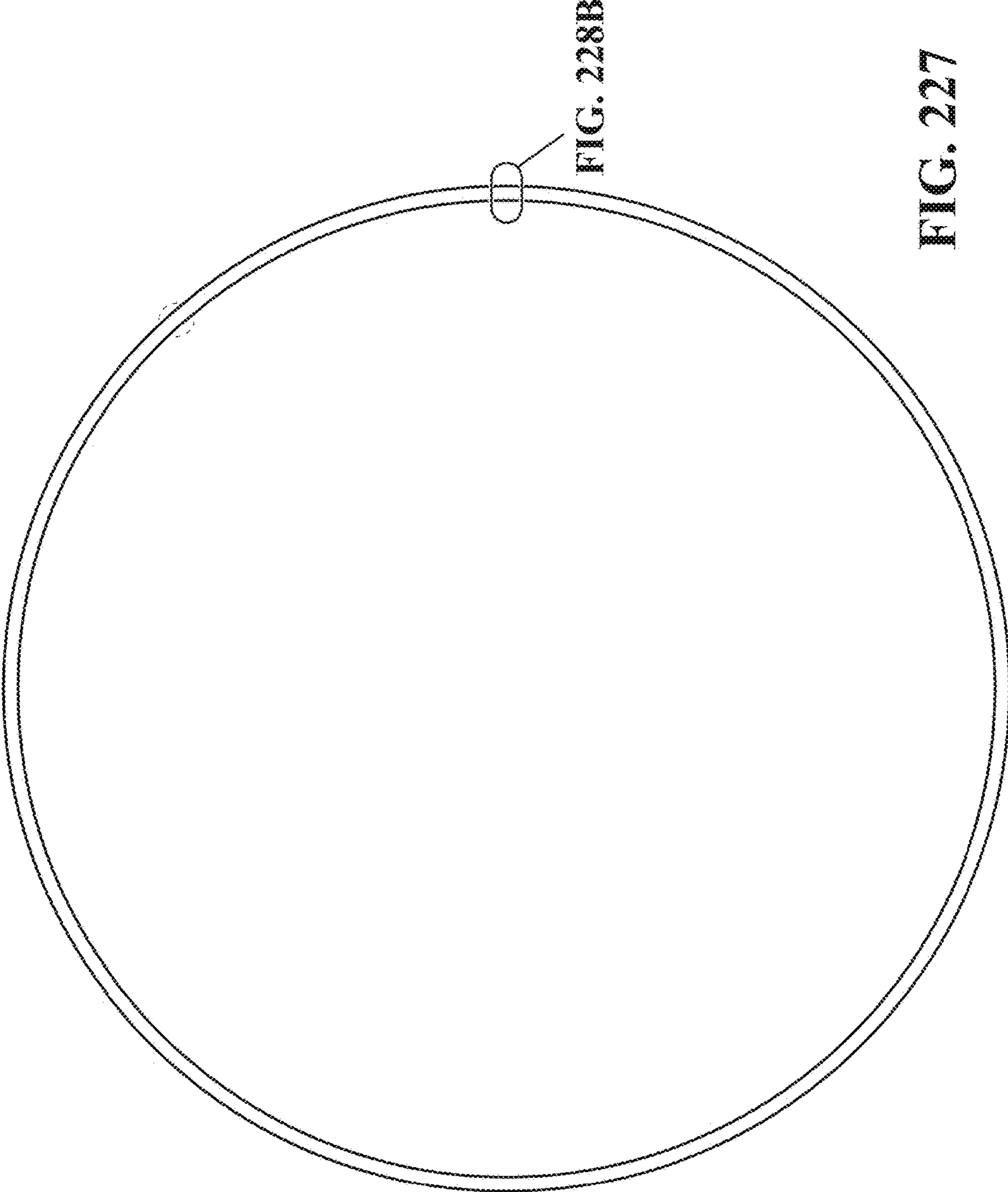

FIG. 228B

FIG. 227

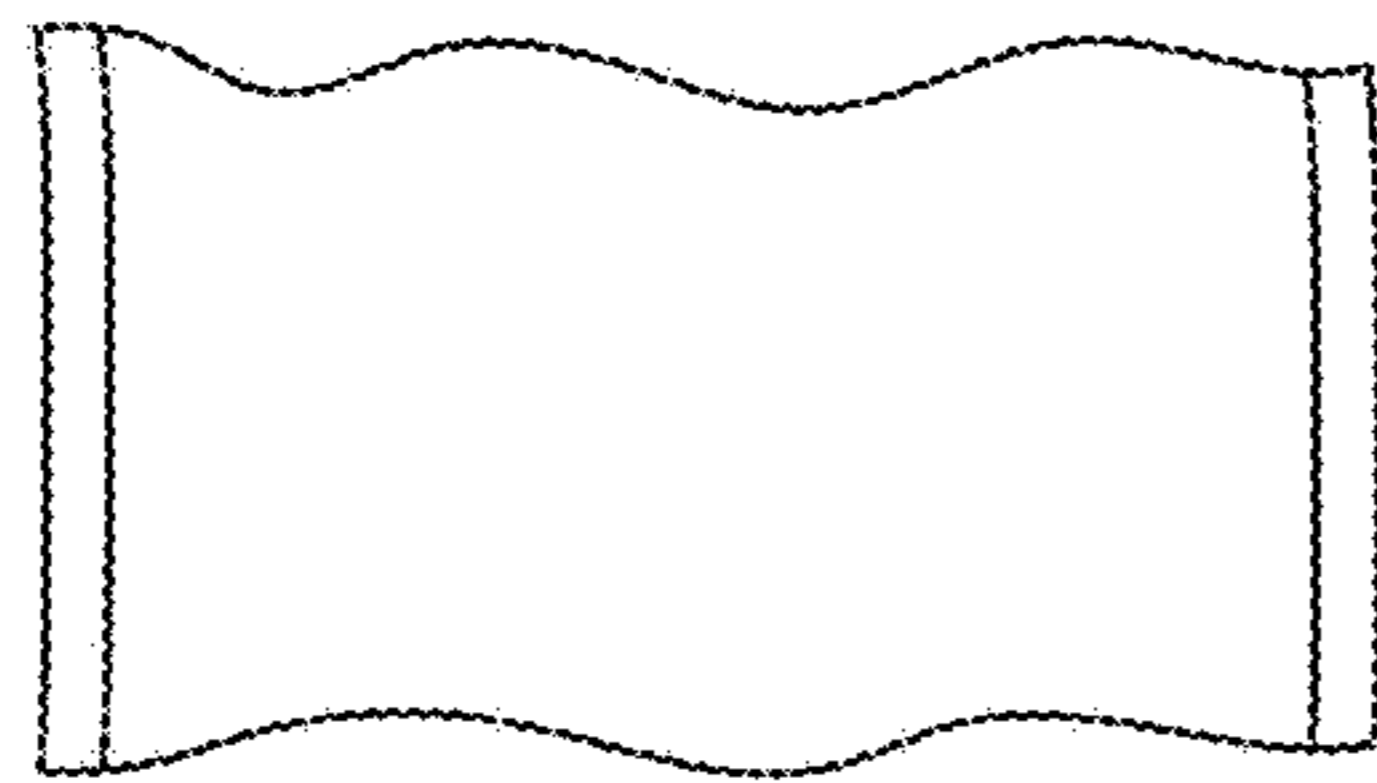

FIG. 228A

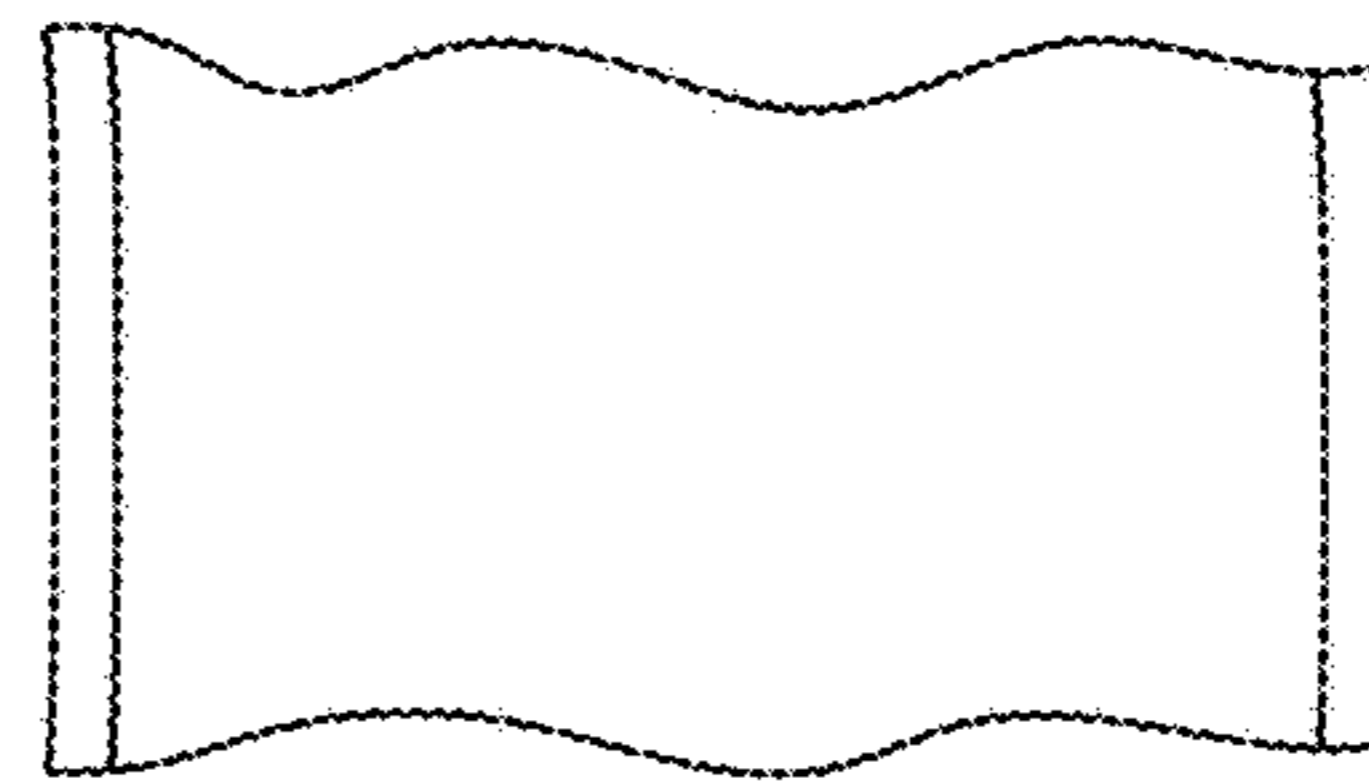

FIG. 228B

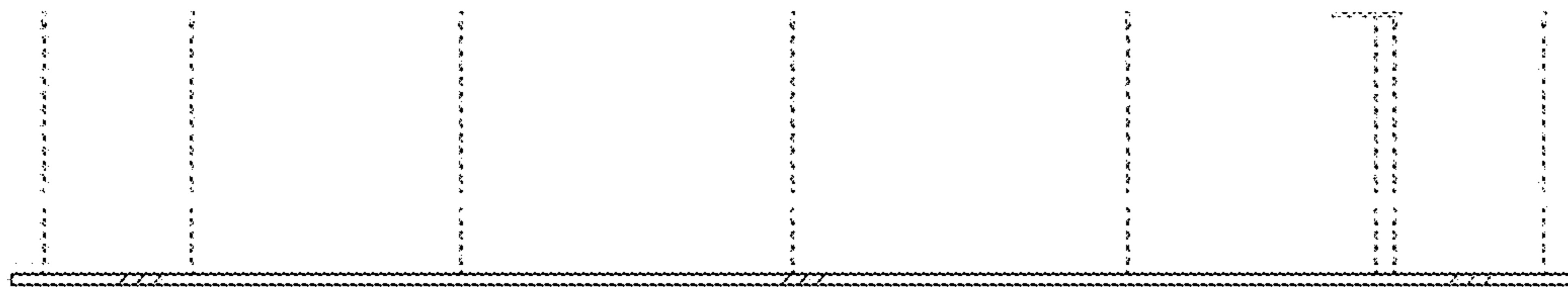

FIG. 229

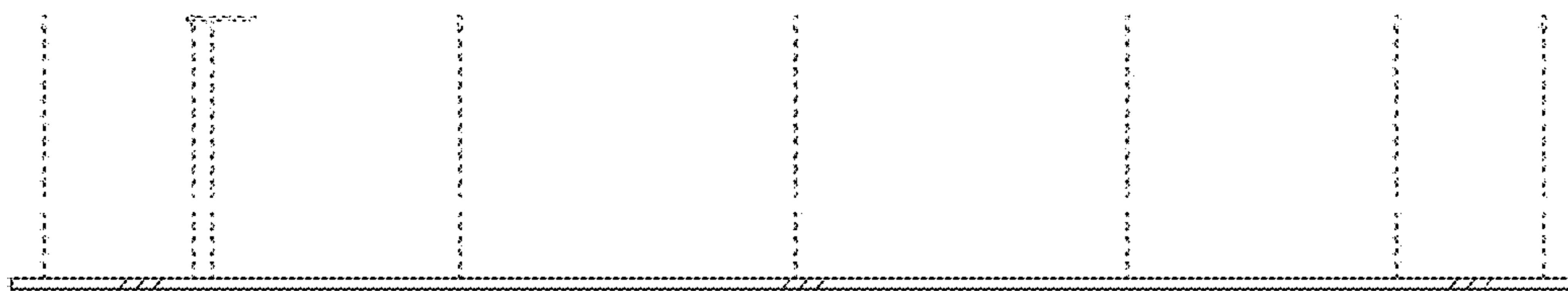

FIG. 230

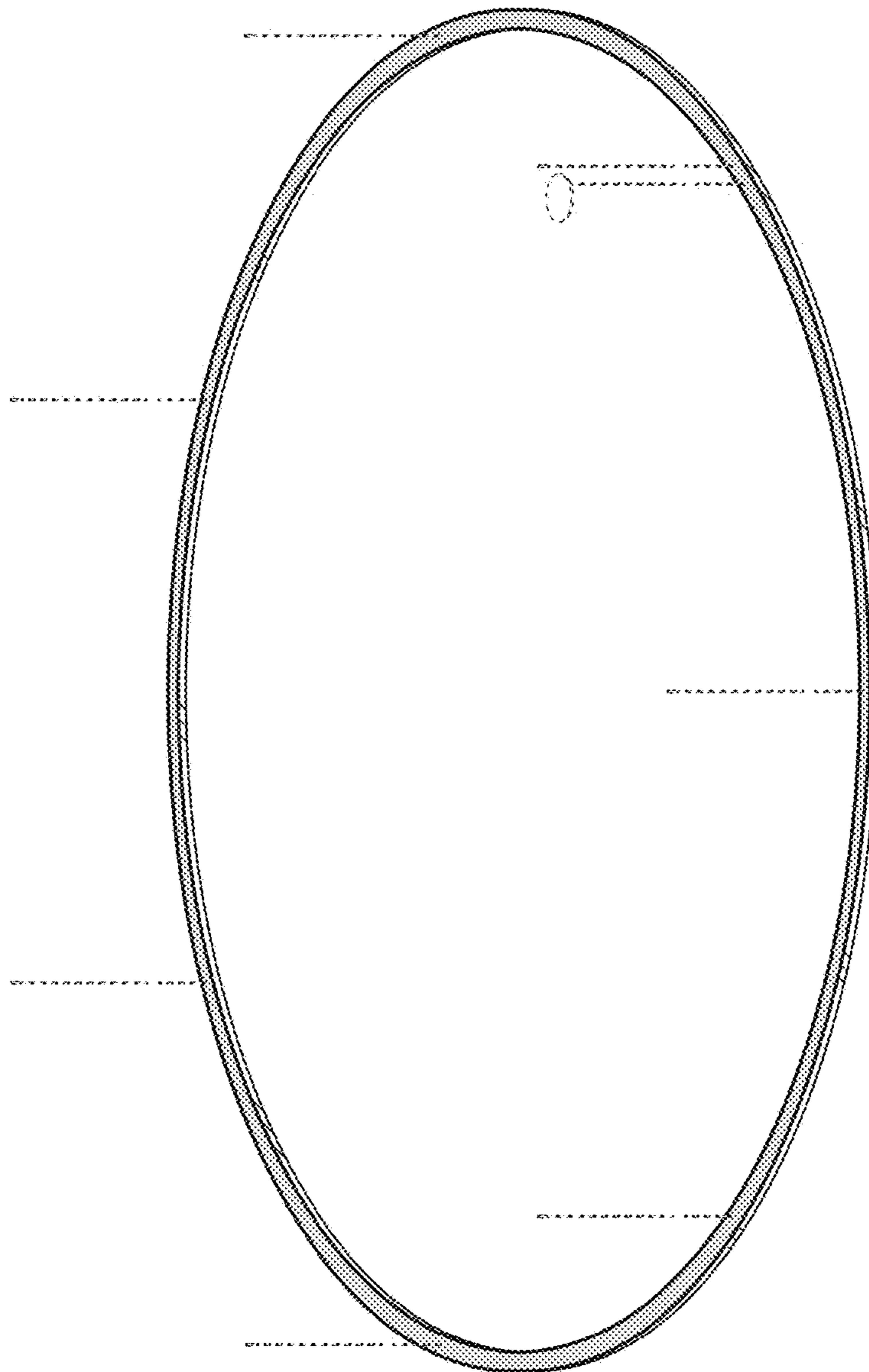
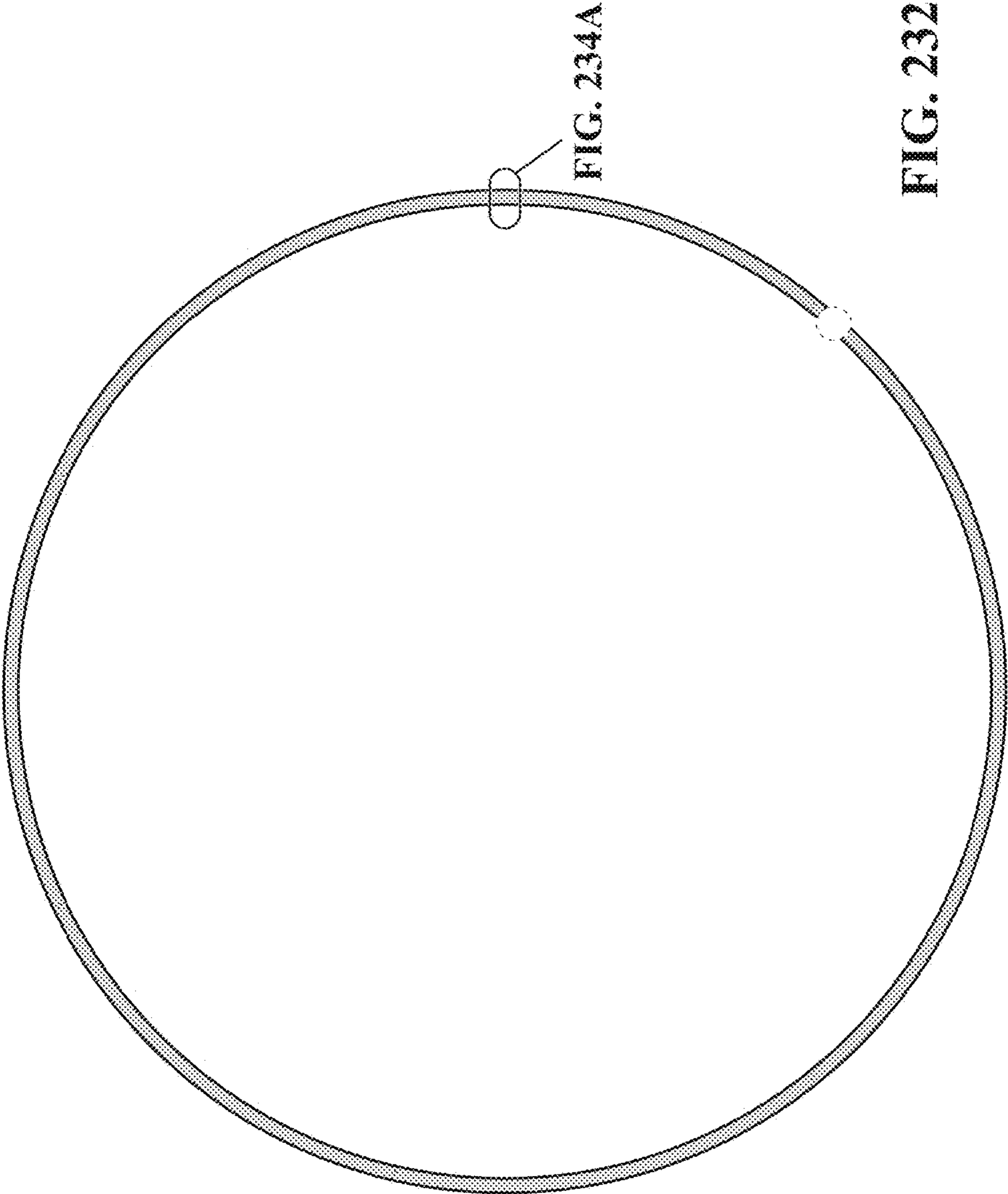

FIG. 231



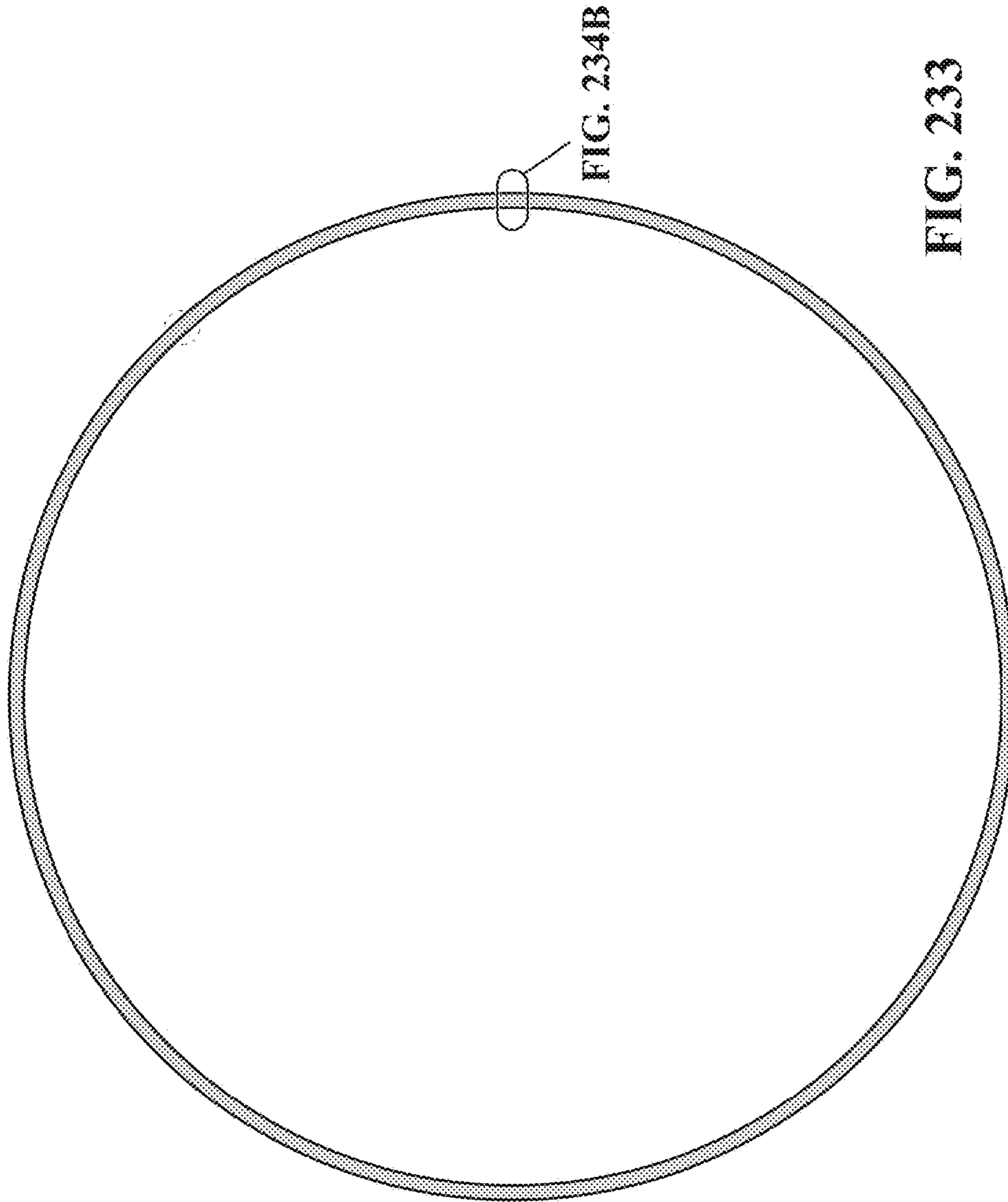

FIG. 234B

FIG. 233

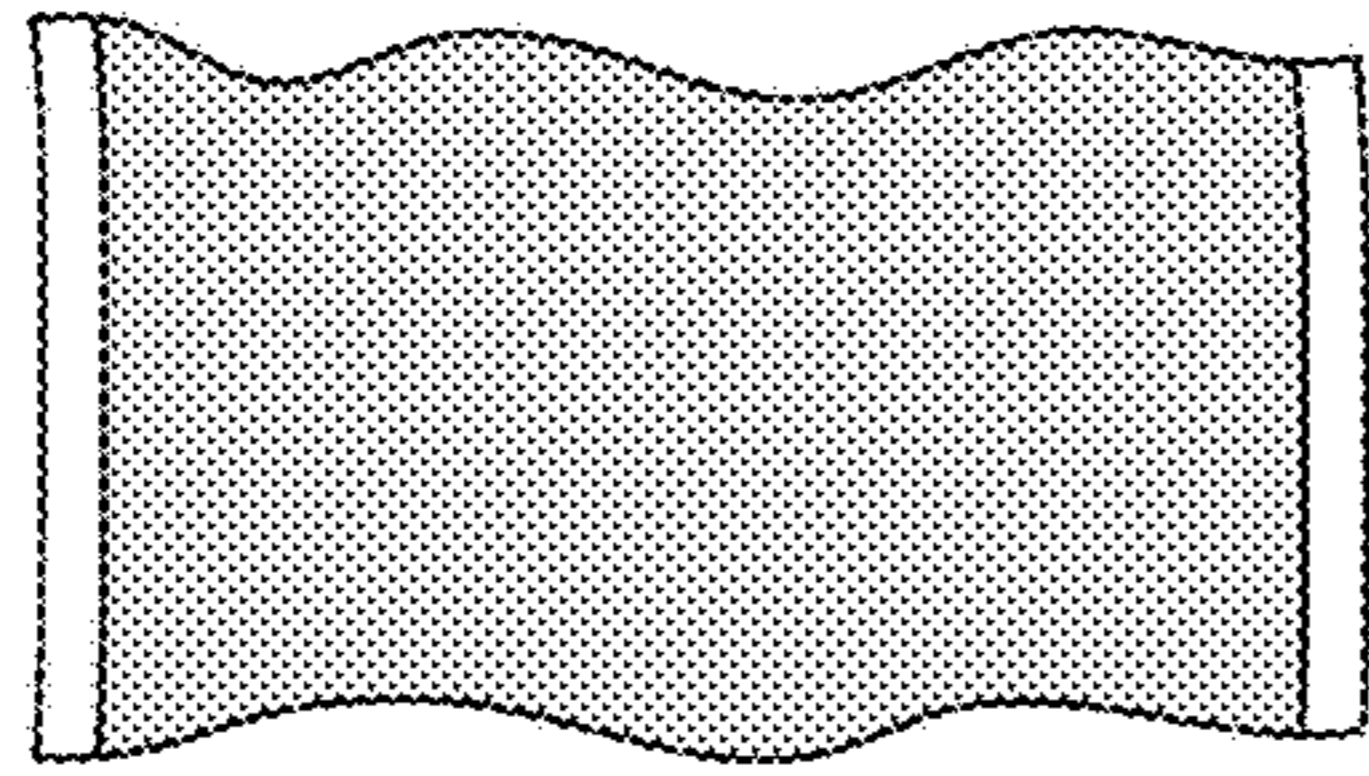

FIG. 234A

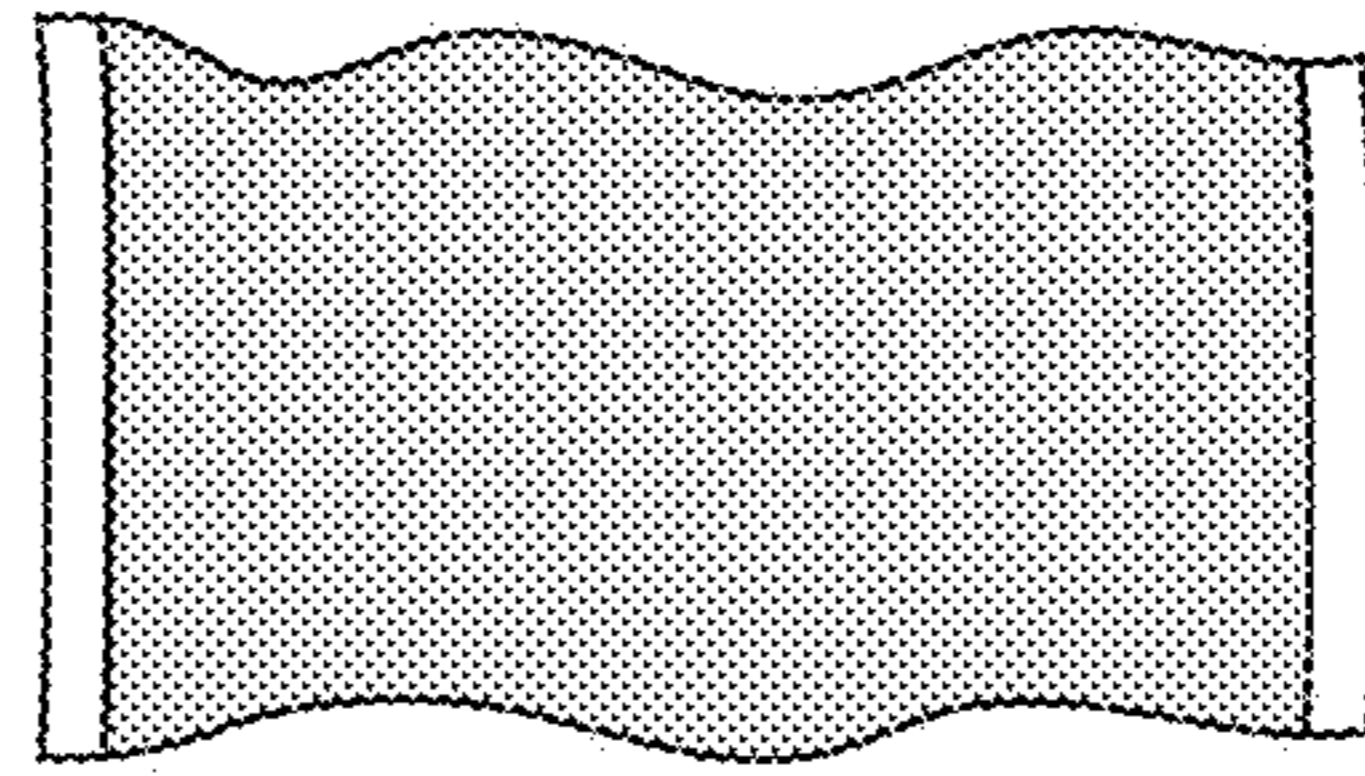

FIG. 234B

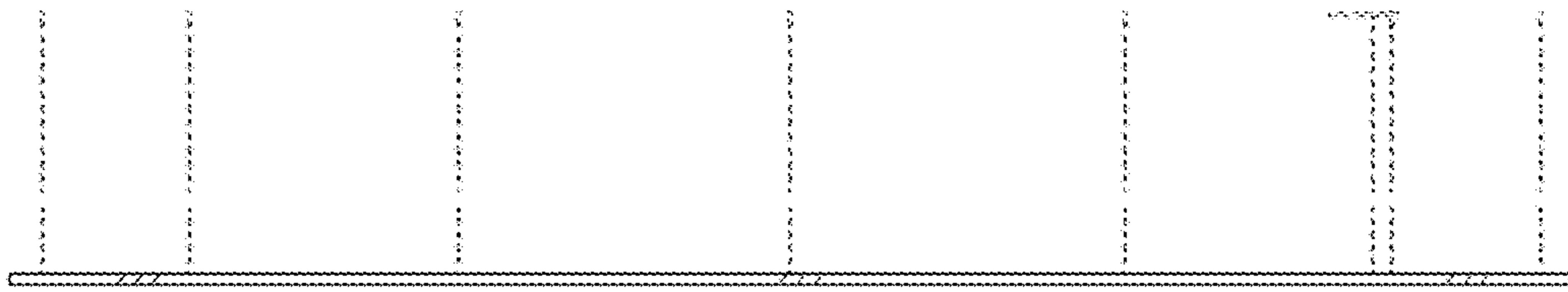

FIG. 235

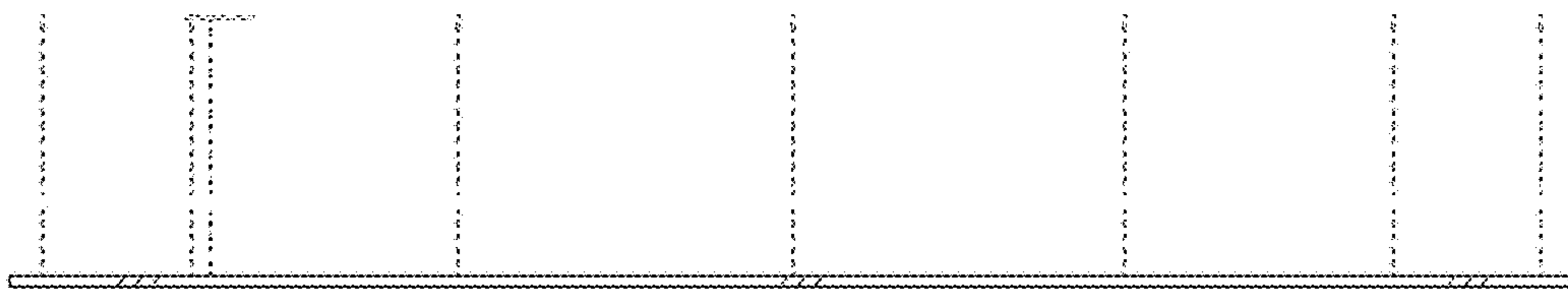

FIG. 236