



US00D835257S

(12) **United States Design Patent** (10) **Patent No.:** **US D835,257 S**
Parikh et al. (45) **Date of Patent:** **** *Dec. 4, 2018**

- (54) **PHARMACEUTICAL TABLET**
- (71) Applicant: **Celgene Corporation**, Summit, NJ (US)
- (72) Inventors: **Darshan Parikh**, Bridgewater, NJ (US); **Scott Burnside**, Wilmington, NC (US); **Sreenivas S. Bhat**, Kendall Park, NJ (US); **Jiping Liu**, Basking Ridge, NJ (US)
- (73) Assignee: **Celgene Corporation**, Summit, NJ (US)
- (*) Notice: This patent is subject to a terminal disclaimer.
- (**) Term: **15 Years**
- (21) Appl. No.: **29/594,822**
- (22) Filed: **Feb. 22, 2017**
- (51) **LOC (11) Cl.** **24-01**
- (52) **U.S. Cl.**
USPC **D24/101**
- (58) **Field of Classification Search**
USPC D24/100–104
CPC A61K 9/20; A61K 9/2072; A61K 9/2077; A61K 9/2086
See application file for complete search history.

- (56) **References Cited**
U.S. PATENT DOCUMENTS
- | | | | |
|--------------|---------|-------------------|---------|
| D31,133 S | 7/1899 | Lantz | |
| D301,764 S * | 6/1989 | Contractor | D24/102 |
| D302,051 S | 7/1989 | Contractor et al. | |
| 5,770,225 A | 6/1998 | Parekh et al. | |
| 5,824,338 A | 10/1998 | Jacobs et al. | |
| D403,396 S | 12/1998 | Lundbom et al. | |
| D408,910 S * | 4/1999 | Lundbom | D24/101 |
| D425,614 S | 5/2000 | Chen et al. | |
| D430,285 S | 8/2000 | Chen et al. | |
| D431,076 S * | 9/2000 | Chen | D24/102 |

- D434,846 S * 12/2000 Chen D24/102
 - 6,165,513 A 12/2000 Dansereau et al.
 - D459,798 S * 7/2002 Desesquelle D24/101
 - D506,544 S 6/2005 Rinker et al.
 - D515,202 S * 2/2006 Chen D24/102
- (Continued)

FOREIGN PATENT DOCUMENTS

JP D10612561 10/1999

OTHER PUBLICATIONS

U.S. Appl. No. 29/531,123, filed Jun. 23, 2015, Parikh et al.
(Continued)

Primary Examiner — Charles D Hanson
(74) *Attorney, Agent, or Firm* — Jones Day

(57) **CLAIM**

The ornamental design for a pharmaceutical tablet, as shown and described.

DESCRIPTION

FIG. 1 is a top perspective view of a pharmaceutical tablet in accordance with the present design;
 FIG. 2 is a top plan view thereof;
 FIG. 3 is a bottom plan view thereof;
 FIG. 4 is a side elevational view thereof;
 FIG. 5 is the opposite side elevational view thereof;
 FIG. 6 is an end elevational view thereof;
 FIG. 7 is the opposite end elevational view thereof;
 FIG. 8 is a top perspective view of a pharmaceutical tablet in accordance with a second embodiment of the present design;
 FIG. 9 is a top plan view thereof;
 FIG. 10 is a bottom plan view thereof;
 FIG. 11 is a side elevational view thereof;
 FIG. 12 is the opposite side elevational view thereof;
 FIG. 13 is an end elevational view thereof; and,
 FIG. 14 is the opposite end elevational view thereof.

1 Claim, 6 Drawing Sheets

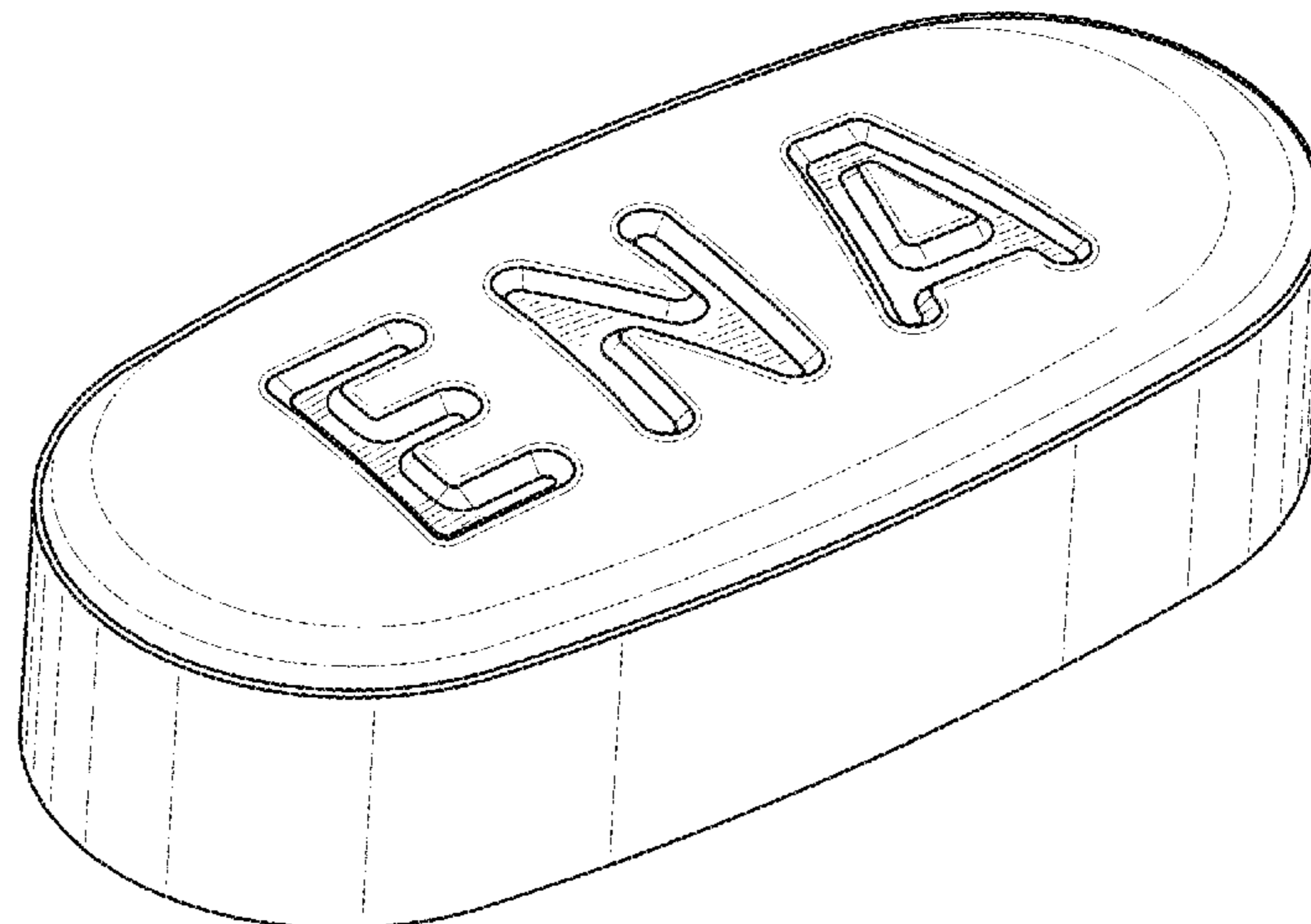

(56)

References Cited

U.S. PATENT DOCUMENTS

D534,646 S	1/2007	Chang et al.	
D535,021 S	1/2007	Stawski et al.	
D564,086 S	3/2008	Nielsen et al.	
D671,636 S	11/2012	Nishino	
D733,315 S	6/2015	Lui	
D741,990 S	10/2015	Ramos	
D787,042 S *	5/2017	Parikh	D24/101
D787,043 S *	5/2017	Parikh	D24/101

OTHER PUBLICATIONS

United States Patent and Trademark Office, Office Action issued in U.S. Appl. No. 29/524,022, dated Apr. 6, 2016.
United States Patent and Trademark Office, Final Office Action issued in U.S. Appl. No. 29/524,022, dated Oct. 18, 2016.

United States Patent and Trademark Office, Office Action issued in U.S. Appl. No. 29/524,022, dated Jan. 10, 2017.
United States Patent and Trademark Office, Office Action issued in U.S. Appl. No. 29/525,253, dated Apr. 11, 2016.
United States Patent and Trademark Office, Final Office Action issued in U.S. Appl. No. 29/525,253, dated Oct. 18, 2016.
United States Patent and Trademark Office, Notice of Allowance issued in U.S. Appl. No. 29/525,253, dated Jan. 13, 2017.
United States Patent and Trademark Office, Office Action issued in U.S. Appl. No. 29/531,113, dated Apr. 12, 2016.
United States Patent and Trademark Office, Final Office Action issued in U.S. Appl. No. 29/531,113, dated Oct. 18, 2016.
United States Patent and Trademark Office, Notice of Allowance issued in U.S. Appl. No. 29/531,113, dated Jan. 17, 2017.
United States Patent and Trademark Office, Office Action issued in U.S. Appl. No. 29/531,123, dated Apr. 11, 2016.
United States Patent and Trademark Office, Final Office Action issued in U.S. Appl. No. 29/531,123, dated Oct. 18, 2016.

* cited by examiner

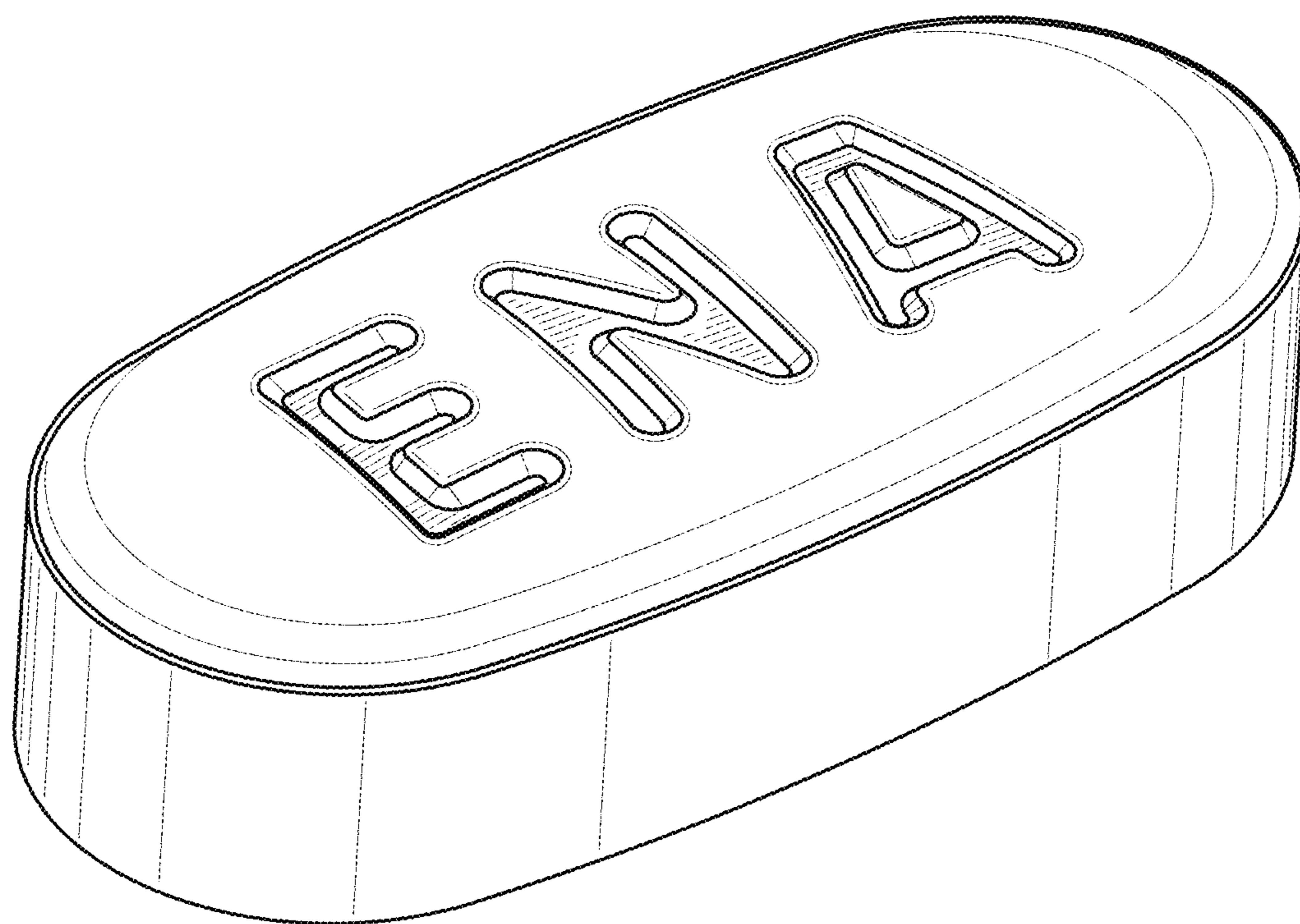

FIG. 1

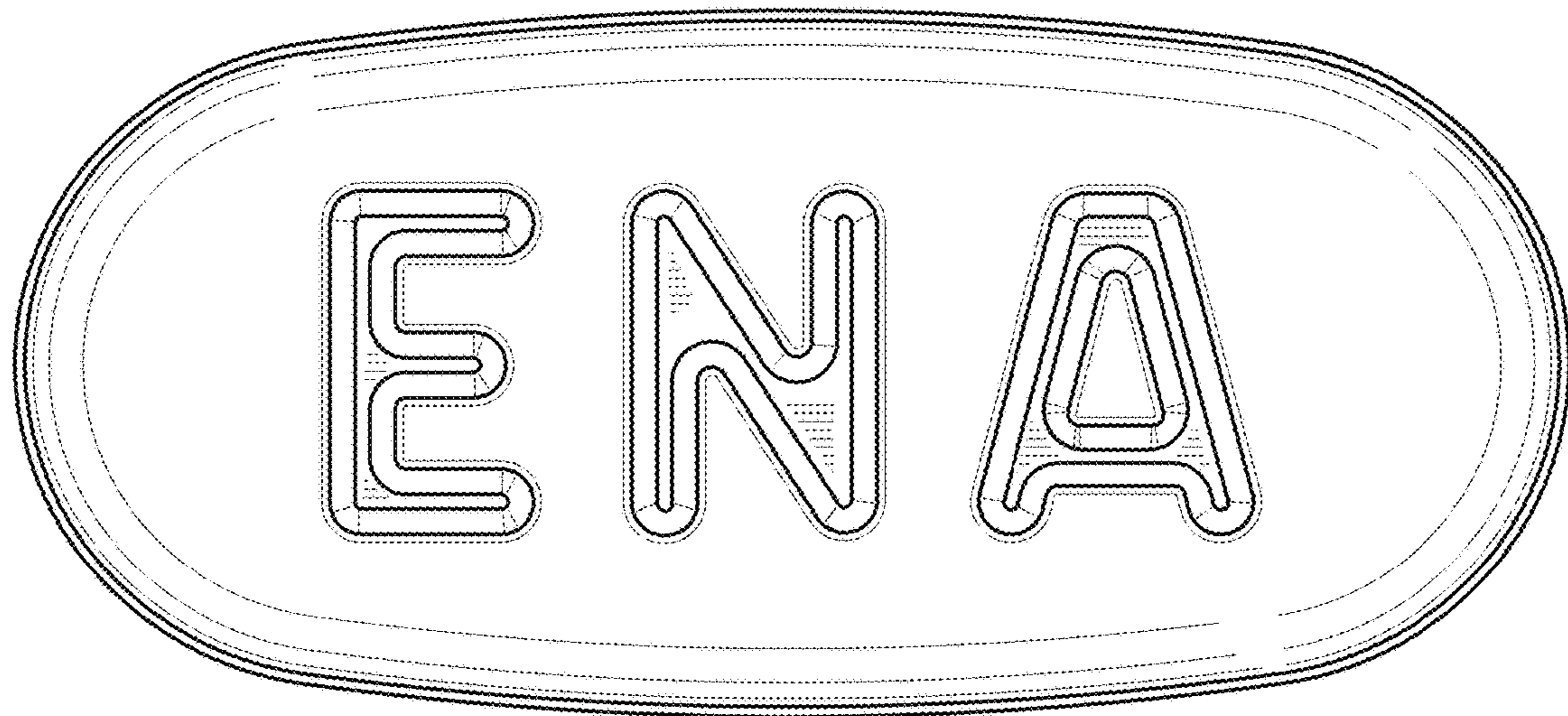

FIG. 2

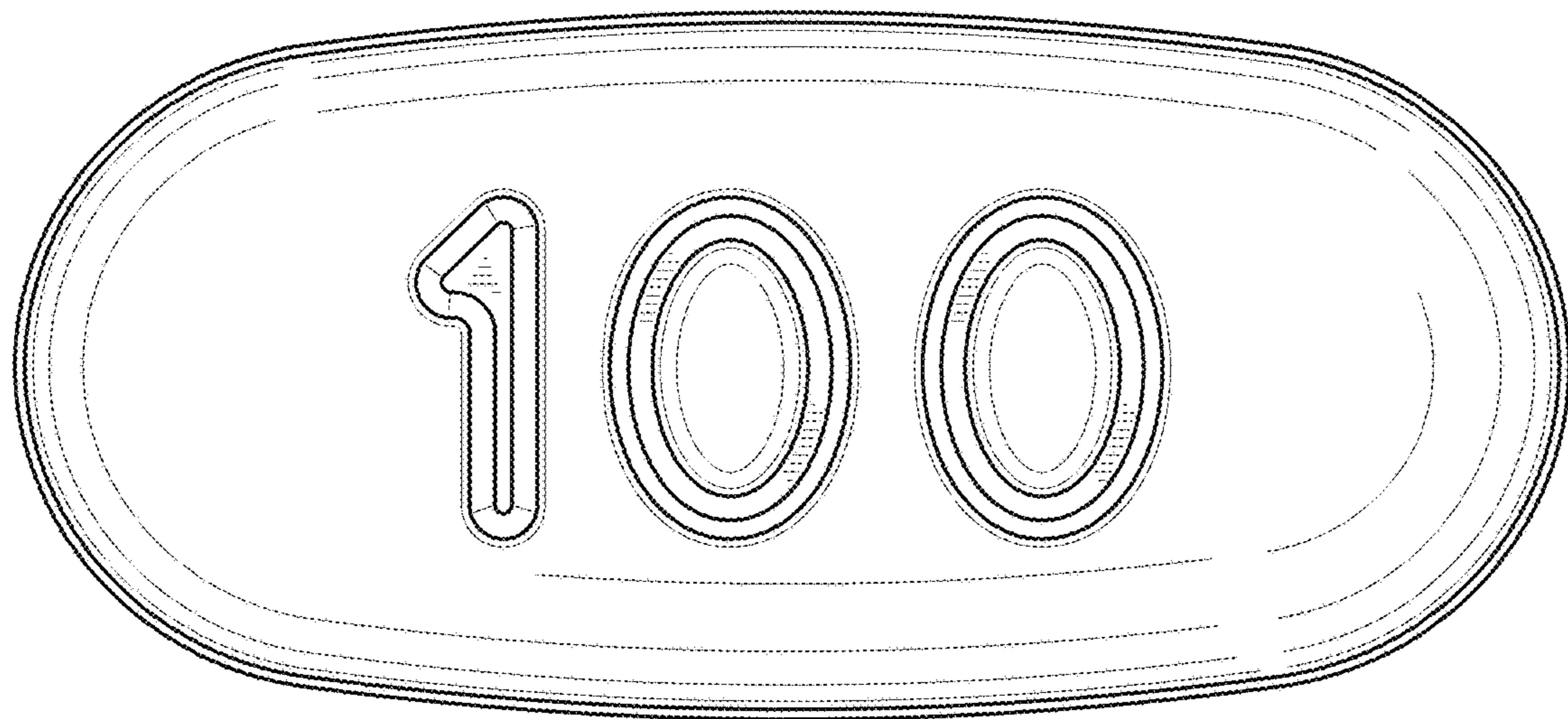

FIG. 3

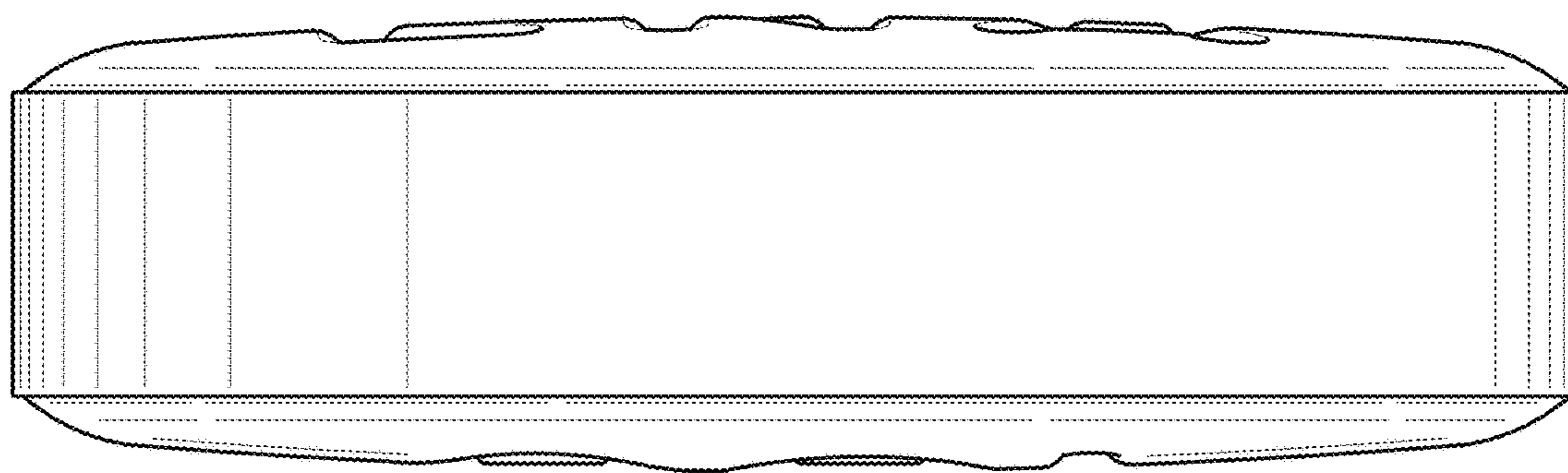

FIG. 4

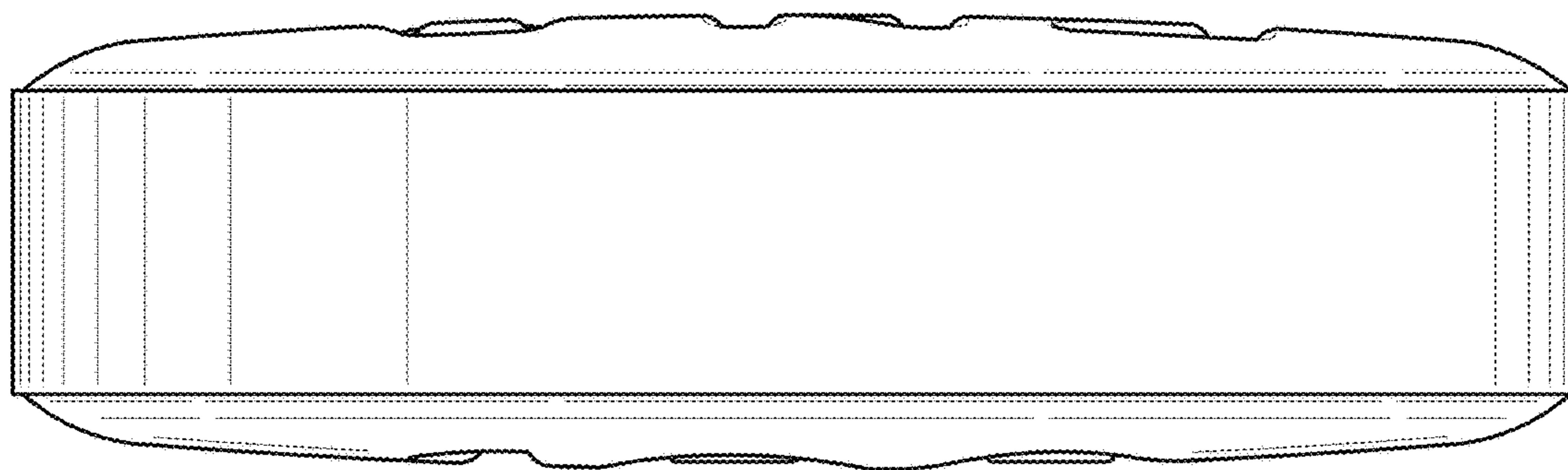

FIG. 5

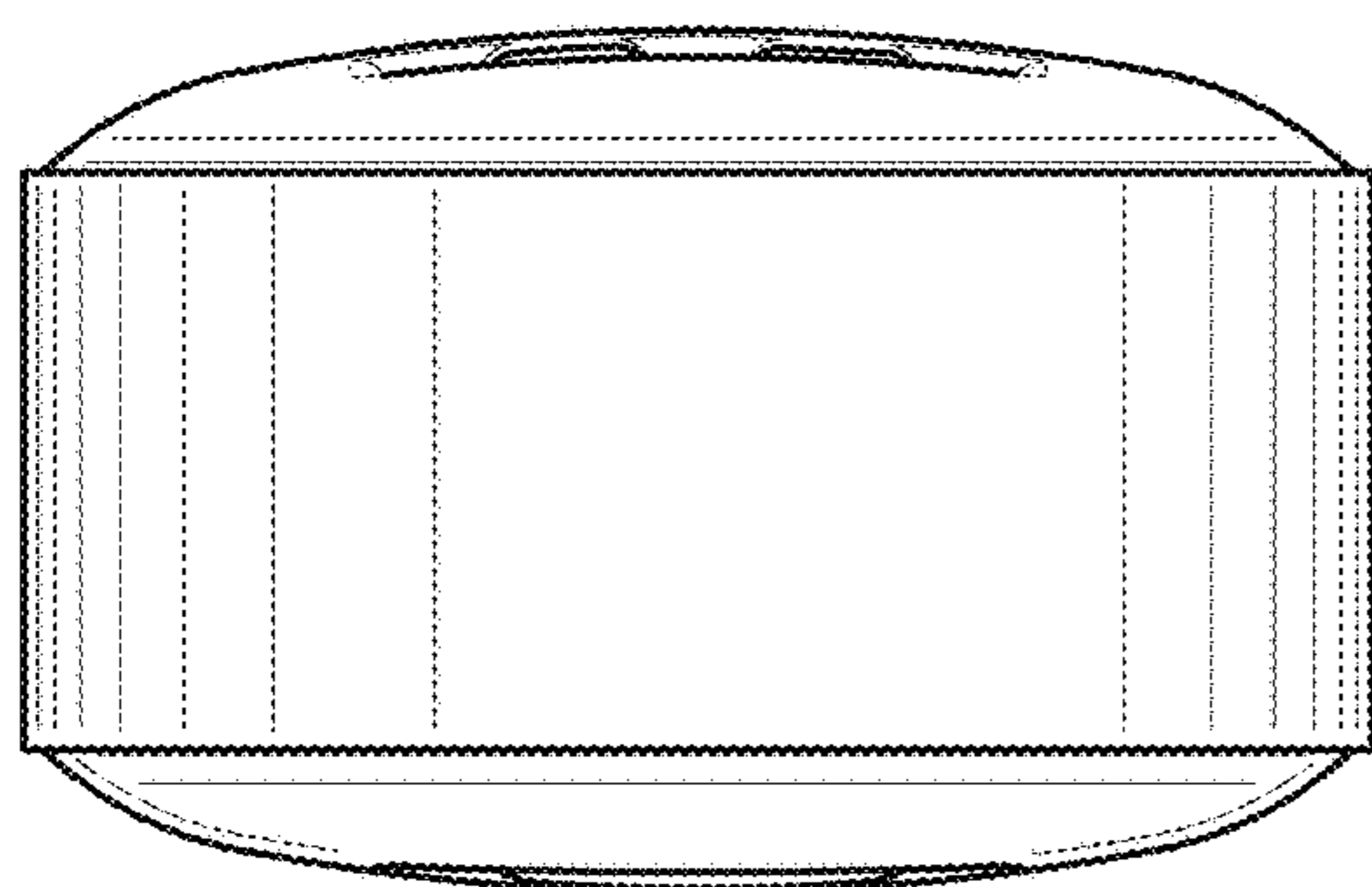

FIG. 6

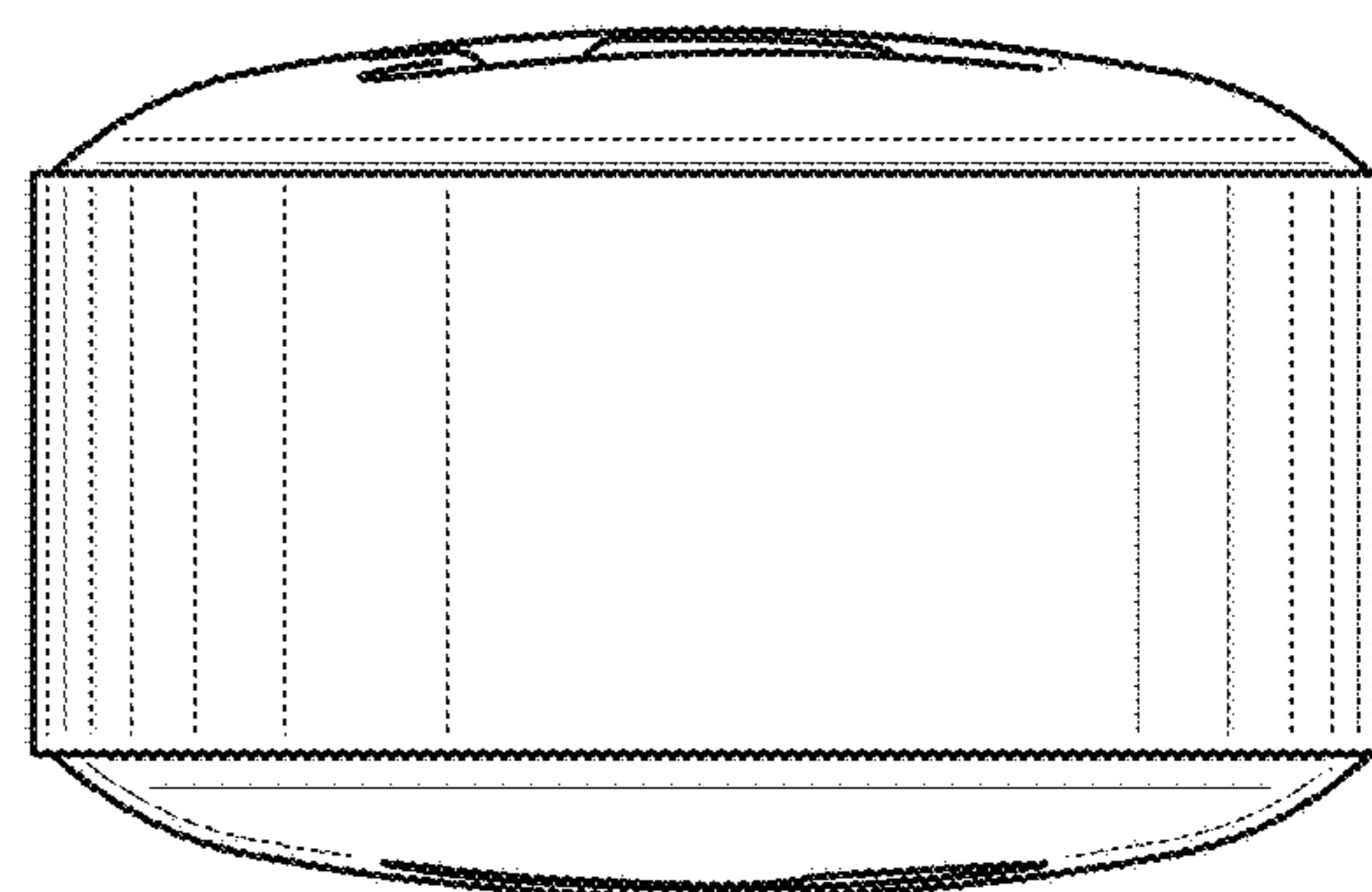

FIG. 7

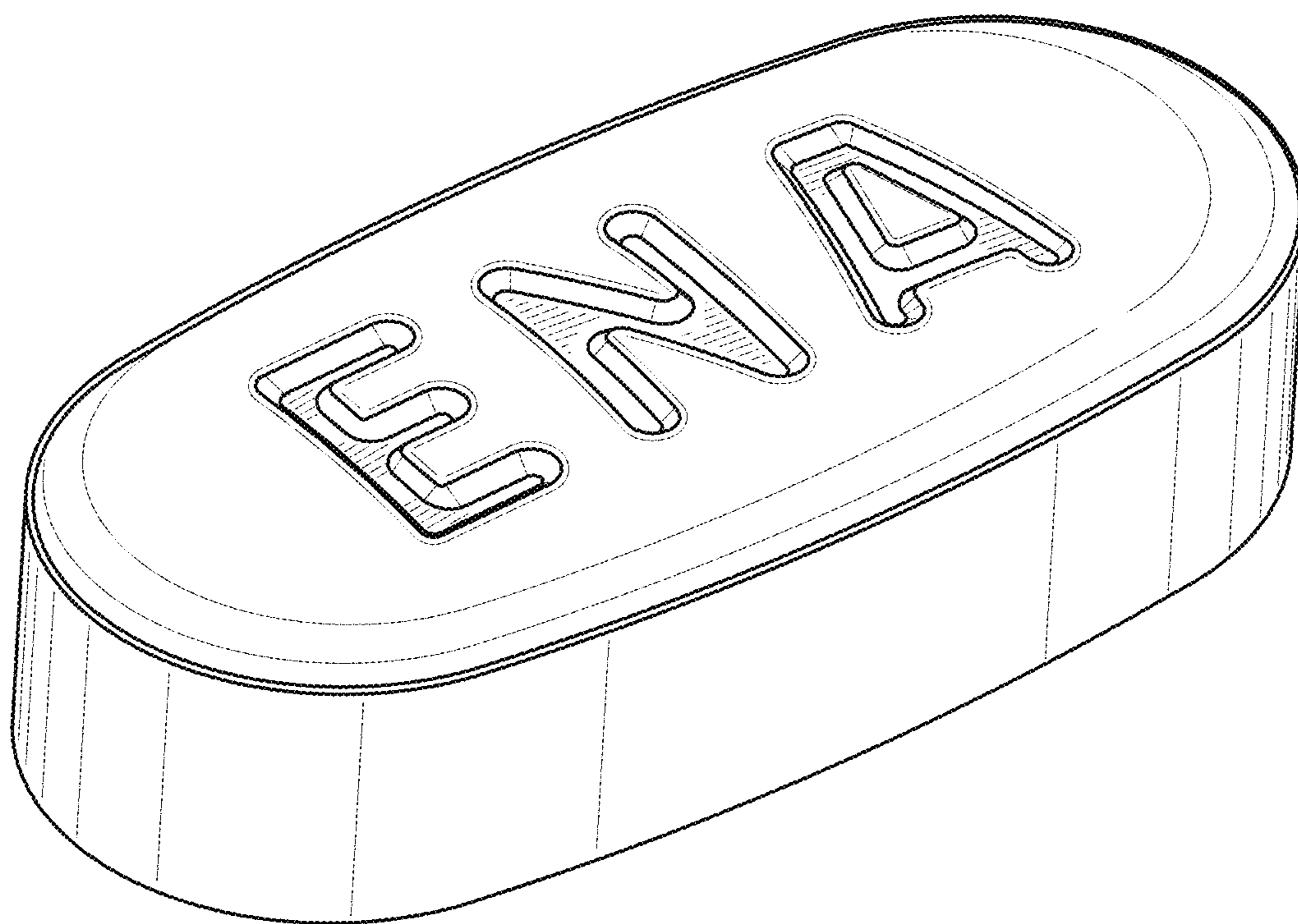

FIG. 8

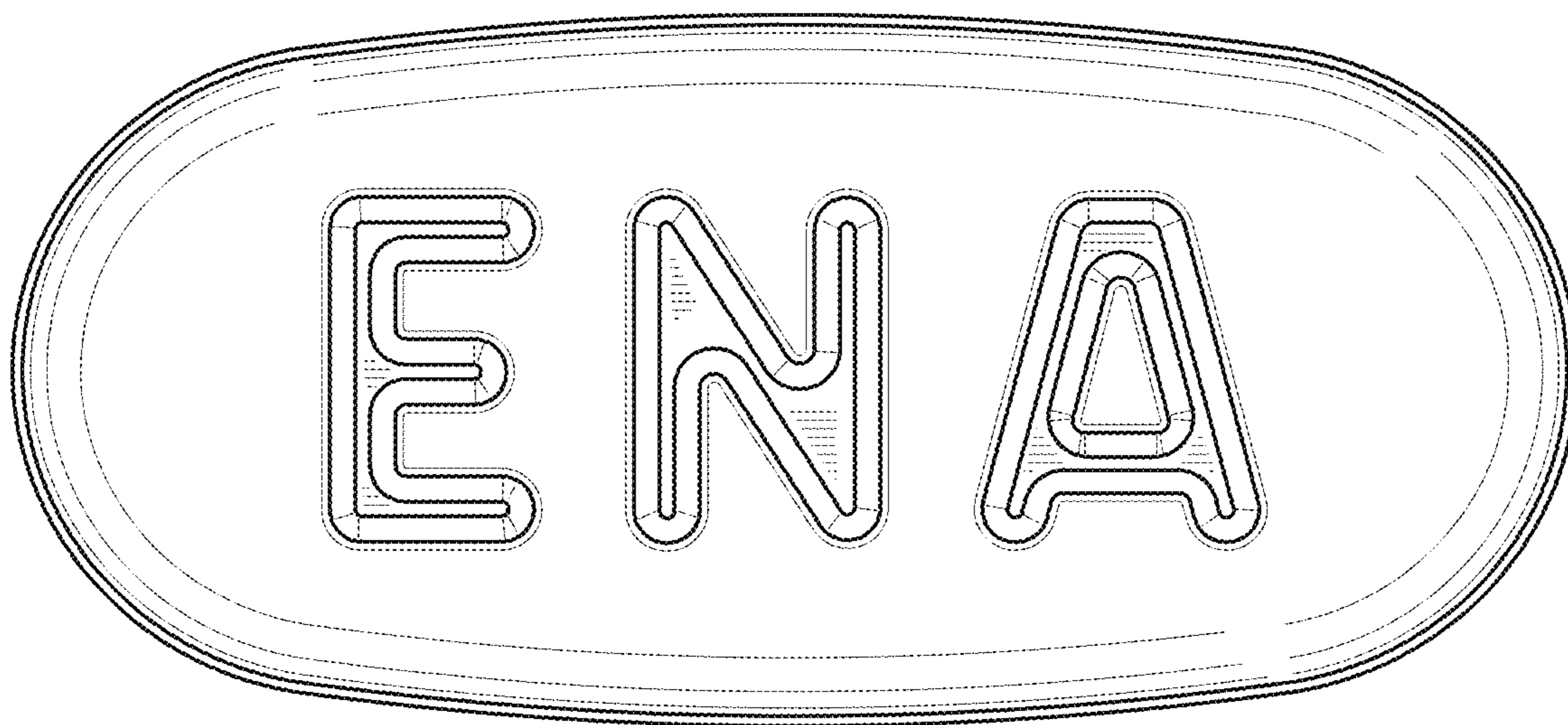

FIG. 9

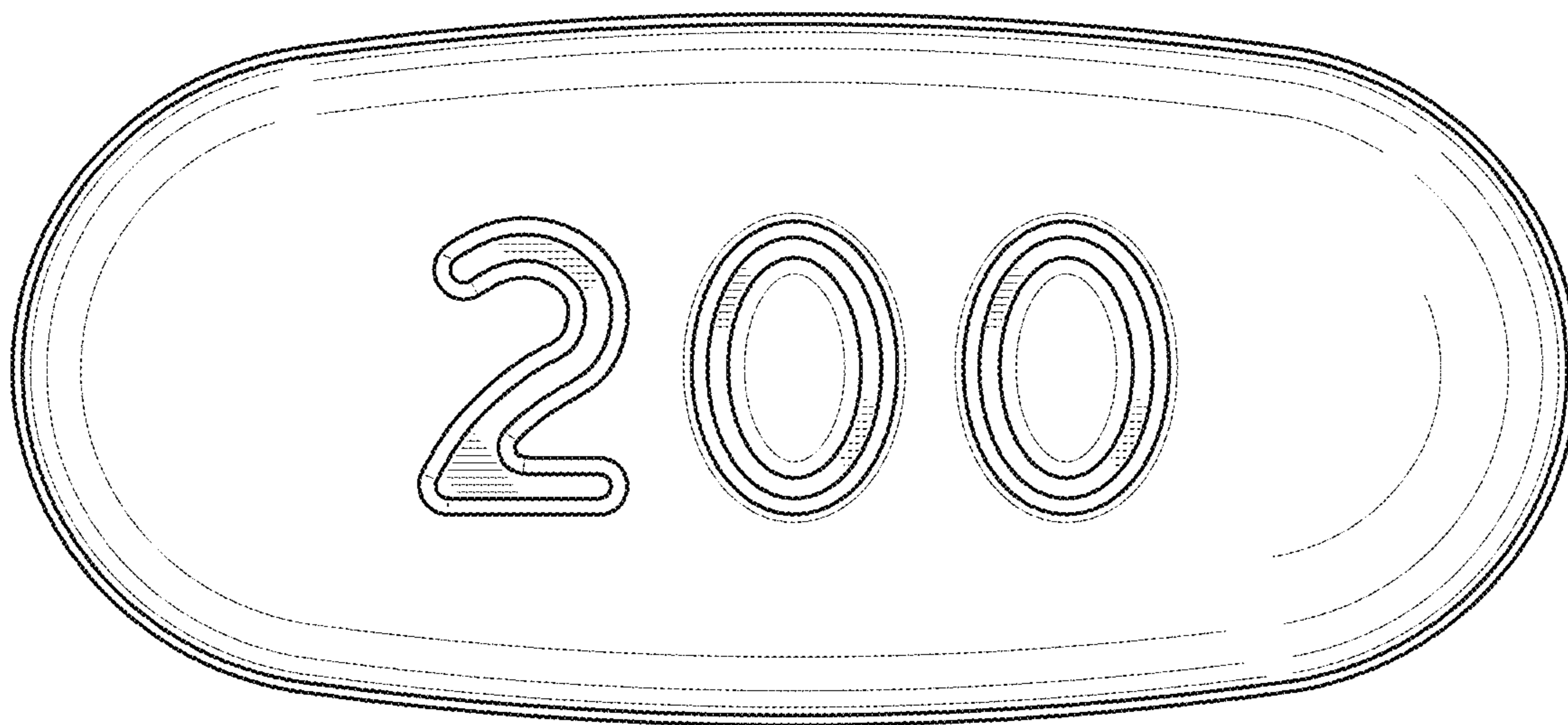

FIG. 10

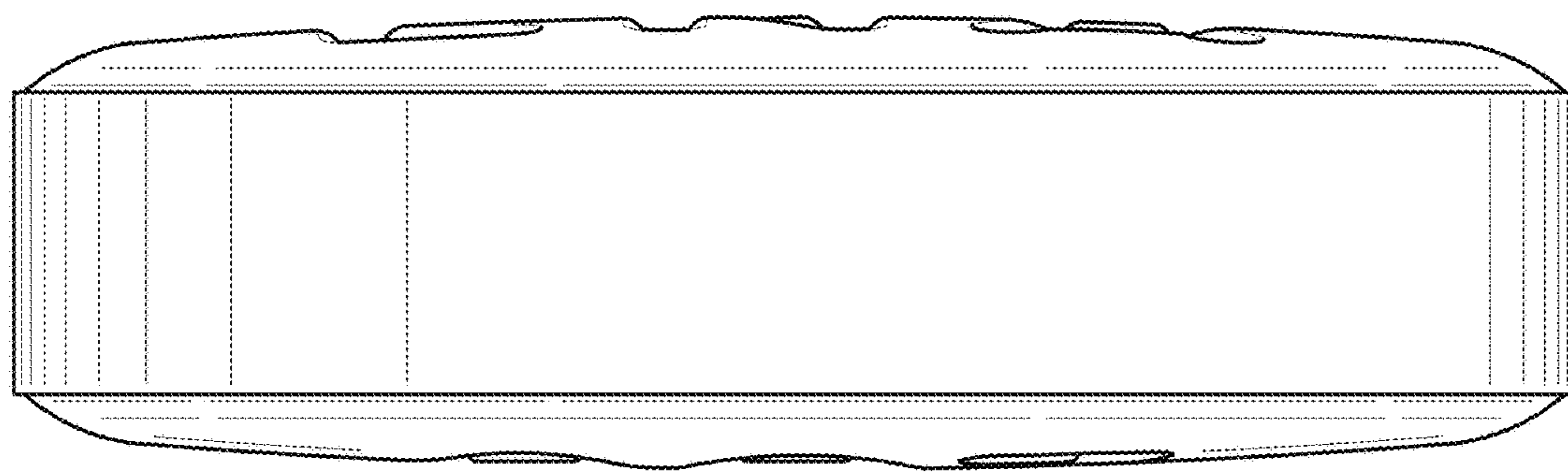

FIG. 11

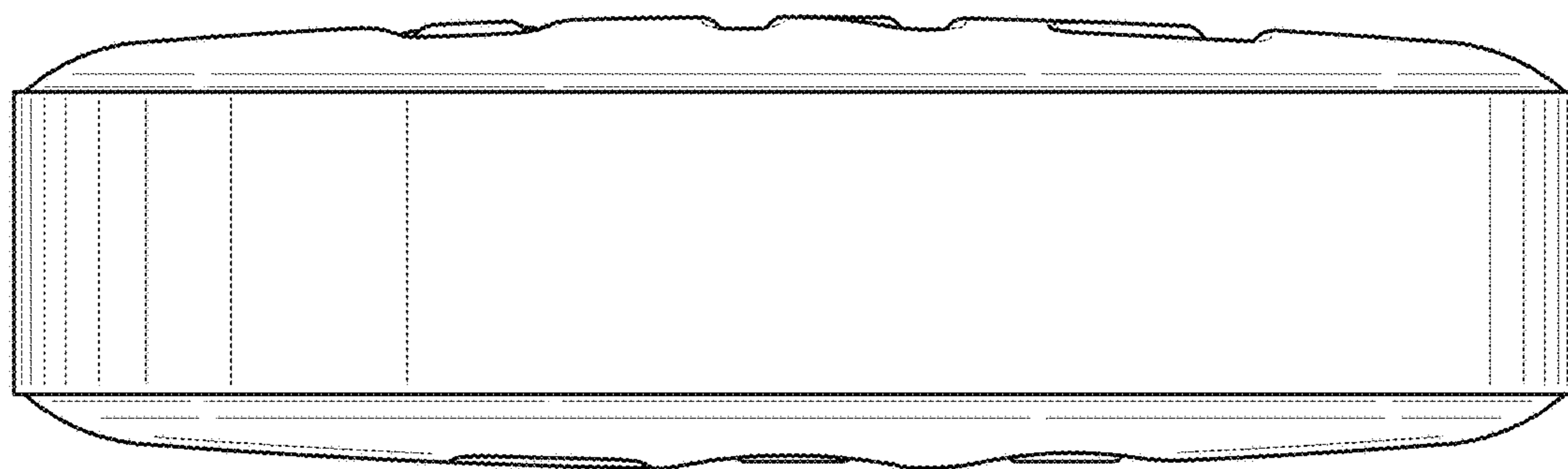

FIG. 12

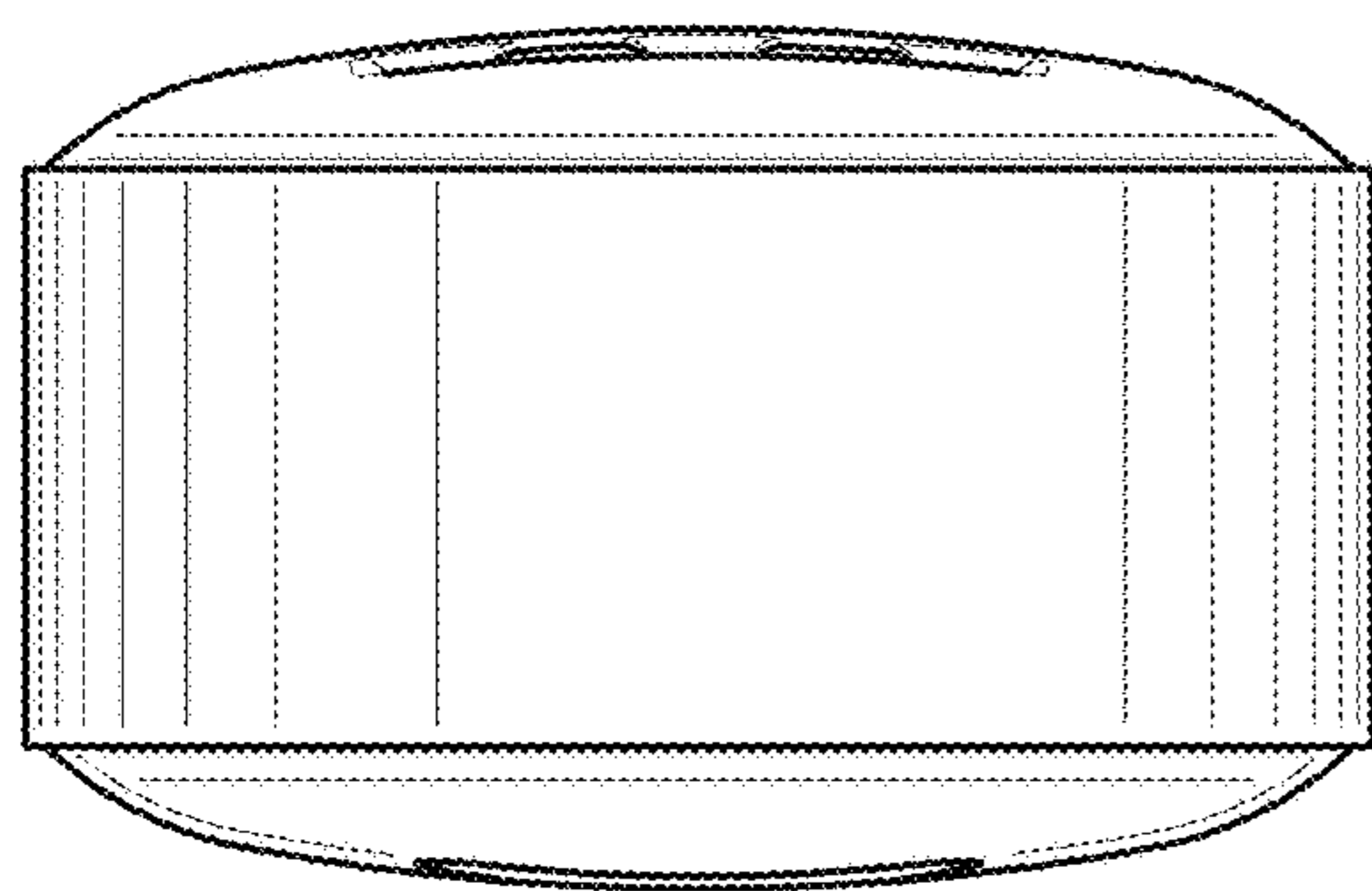

FIG. 13

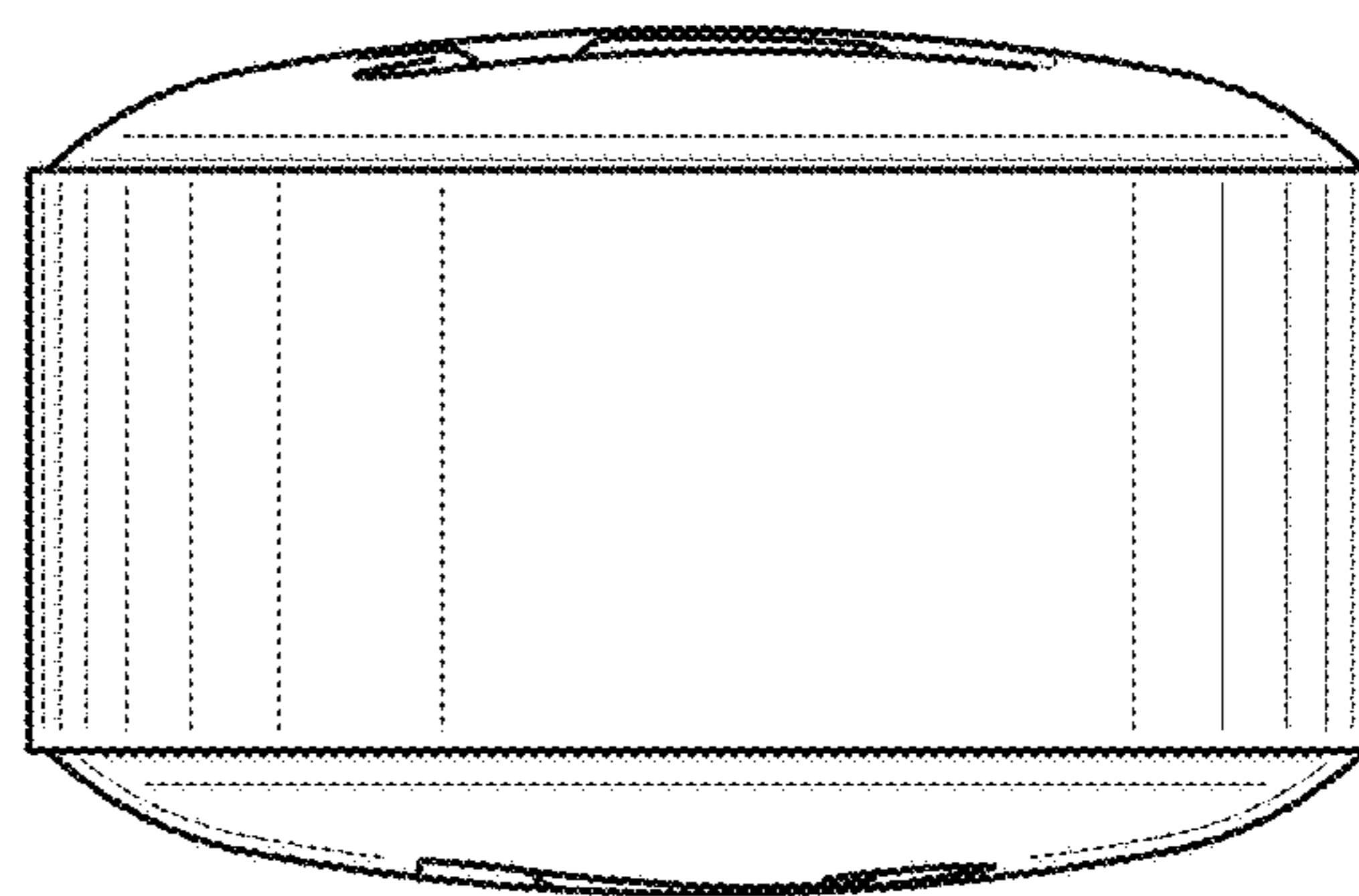

FIG. 14