



US00D835207S

(12) **United States Design Patent** (10) **Patent No.:** **US D835,207 S**  
**Exley** (45) **Date of Patent:** **\*\* Dec. 4, 2018**

(54) **TOY POLICE CAR**  
(71) Applicant: **Ontel Products Corporation**, Fairfield, NJ (US)  
(72) Inventor: **Ross Exley**, Morristown, NJ (US)  
(73) Assignee: **Ontel Products Corporation**, Fairfield, NJ (US)  
(\*\*) Term: **15 Years**  
(21) Appl. No.: **29/594,395**  
(22) Filed: **Feb. 17, 2017**  
(51) **LOC (11) Cl.** ..... **21-01**  
(52) **U.S. Cl.**  
USPC ..... **D21/424**; D21/433; D21/533; D21/548  
(58) **Field of Classification Search**  
USPC ..... D12/86, 90-92, 164, 173, 184-186, 190, D12/196; D21/419, 421, 423, 424-426, D21/433-434, 548, 550, 552, 559; 446/456  
CPC ..... B60R 13/04; B60R 19/54; B62D 25/12; B62D 27/026; B62D 35/005; B60J 5/0412  
See application file for complete search history.

D721,769 S \* 1/2015 Johnson ..... D21/552  
D771,201 S \* 11/2016 Tompkin ..... D21/550  
D771,202 S \* 11/2016 Gan ..... D21/552  
D771,203 S \* 11/2016 Gan ..... D21/552  
2012/0077411 A1\* 3/2012 Amireh ..... A63H 17/32 446/456

**OTHER PUBLICATIONS**

<http://www.mindscopeproducts.com/twister-tracks-255-emergency-series-as-seen-on-tv.html>; 4 pgs.

\* cited by examiner

*Primary Examiner* — Robin V Webster  
*Assistant Examiner* — Keith J Wilson

(74) *Attorney, Agent, or Firm* — John S. Artz; Dickinson Wright PLLC

(57) **CLAIM**

The ornamental design for a toy police car, as shown and described.

**DESCRIPTION**

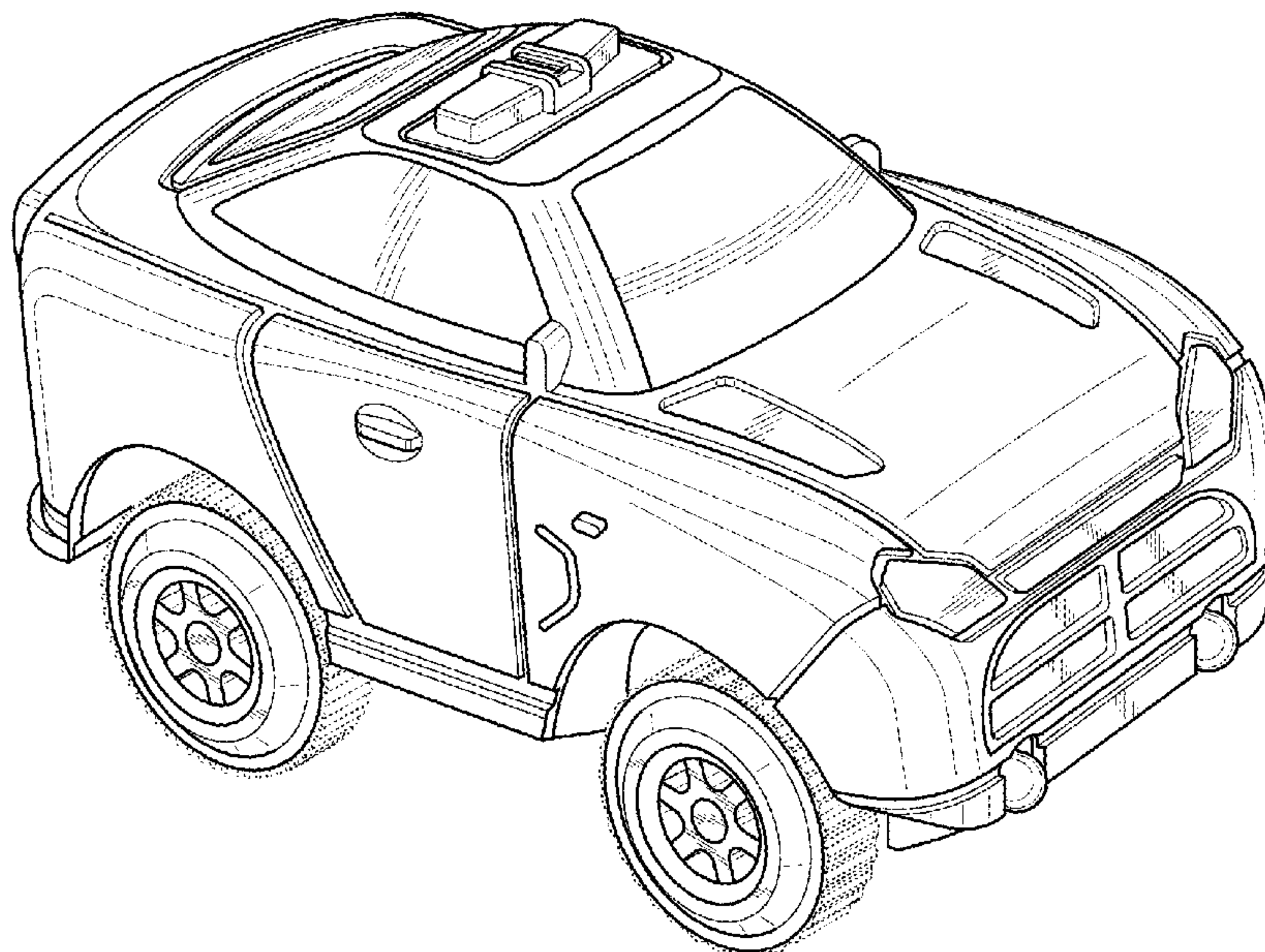
FIG. 1 is a perspective view of a toy police car; FIG. 2 is a front view of the toy police car of FIG. 1; FIG. 3 is a right side view of the toy police car of FIG. 1, and the left side view of the toy police car is a mirror image of FIG. 3; FIG. 4 is a back view of the toy police car of FIG. 1; FIG. 5 is a top view of the toy police car of FIG. 1; and, FIG. 6 is a bottom view of the toy police car of FIG. 1. The broken lines in FIGS. 1-6 represent environment only and form no part of the claimed design.

**1 Claim, 3 Drawing Sheets**

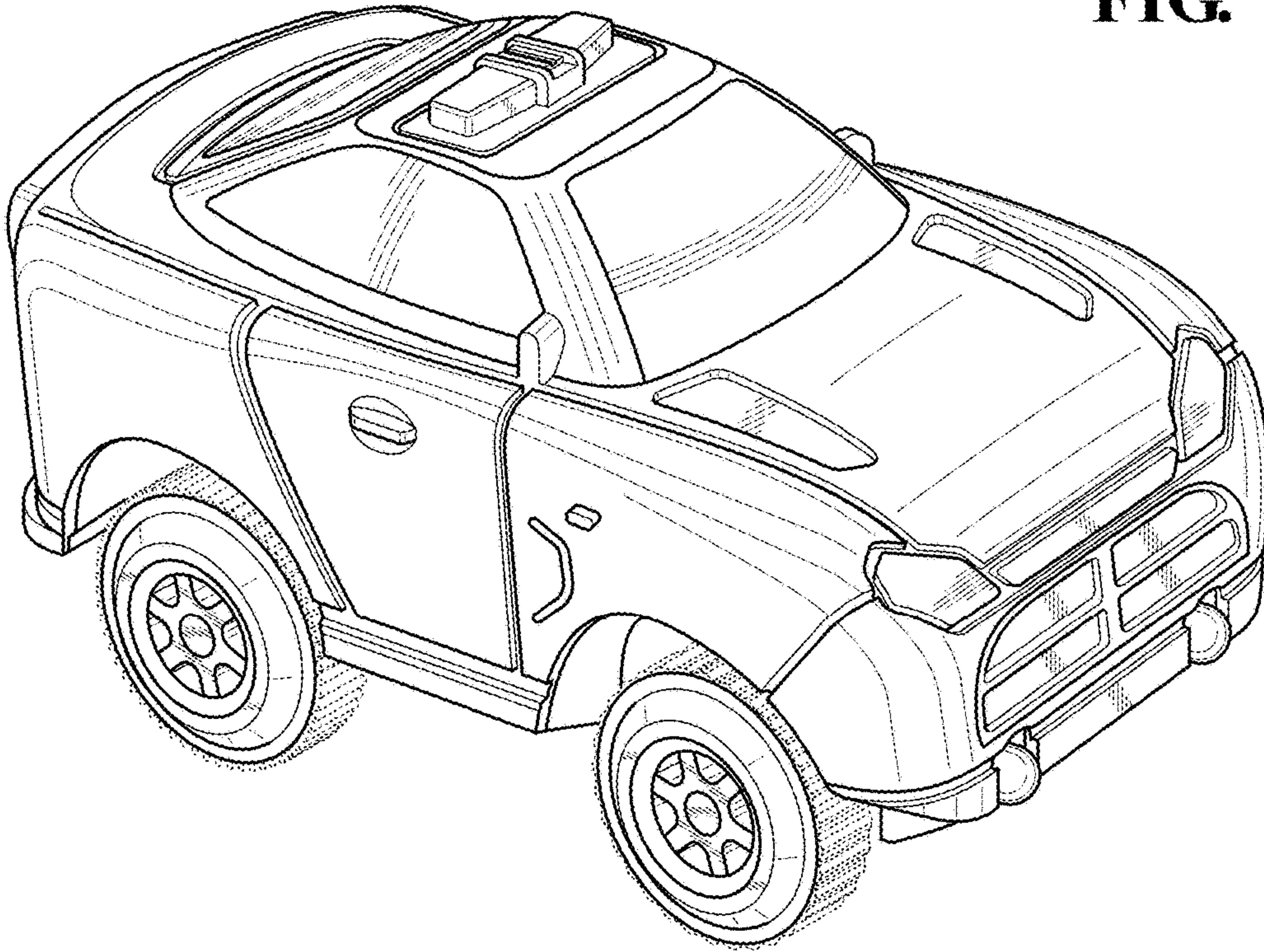
(56) **References Cited**

**U.S. PATENT DOCUMENTS**

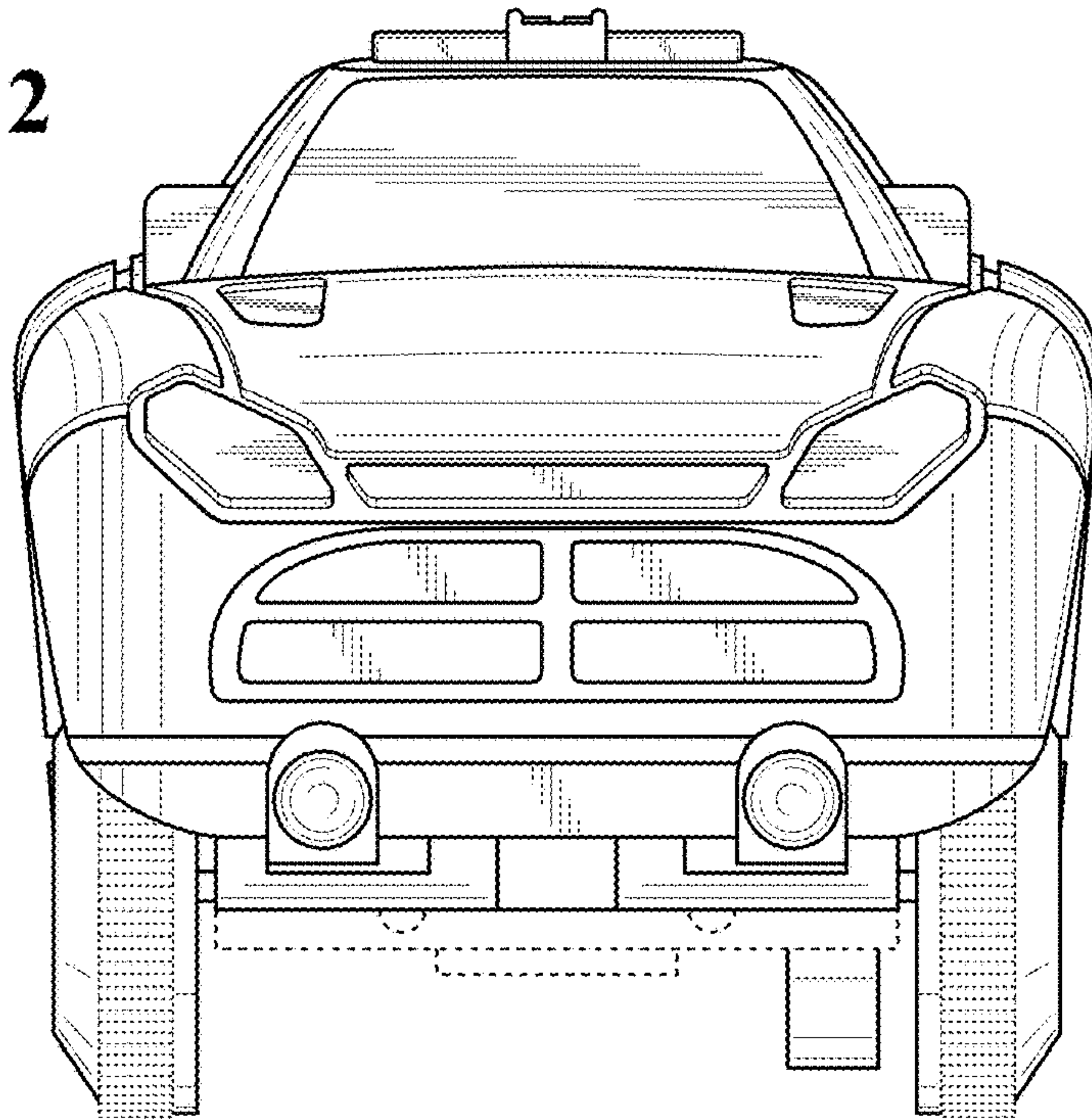
D274,632 S \* 7/1984 Terui ..... D21/559  
D312,488 S \* 11/1990 Kwan ..... D21/551  
D443,318 S \* 6/2001 Tse ..... D21/559  
D457,576 S \* 5/2002 Zweiback ..... D21/548  
D498,798 S \* 11/2004 Wei ..... D21/550  
D540,714 S \* 4/2007 Mueller-Stolz ..... D12/91  
D717,886 S \* 11/2014 Mimlitch, III ..... D21/550



**FIG. 1**

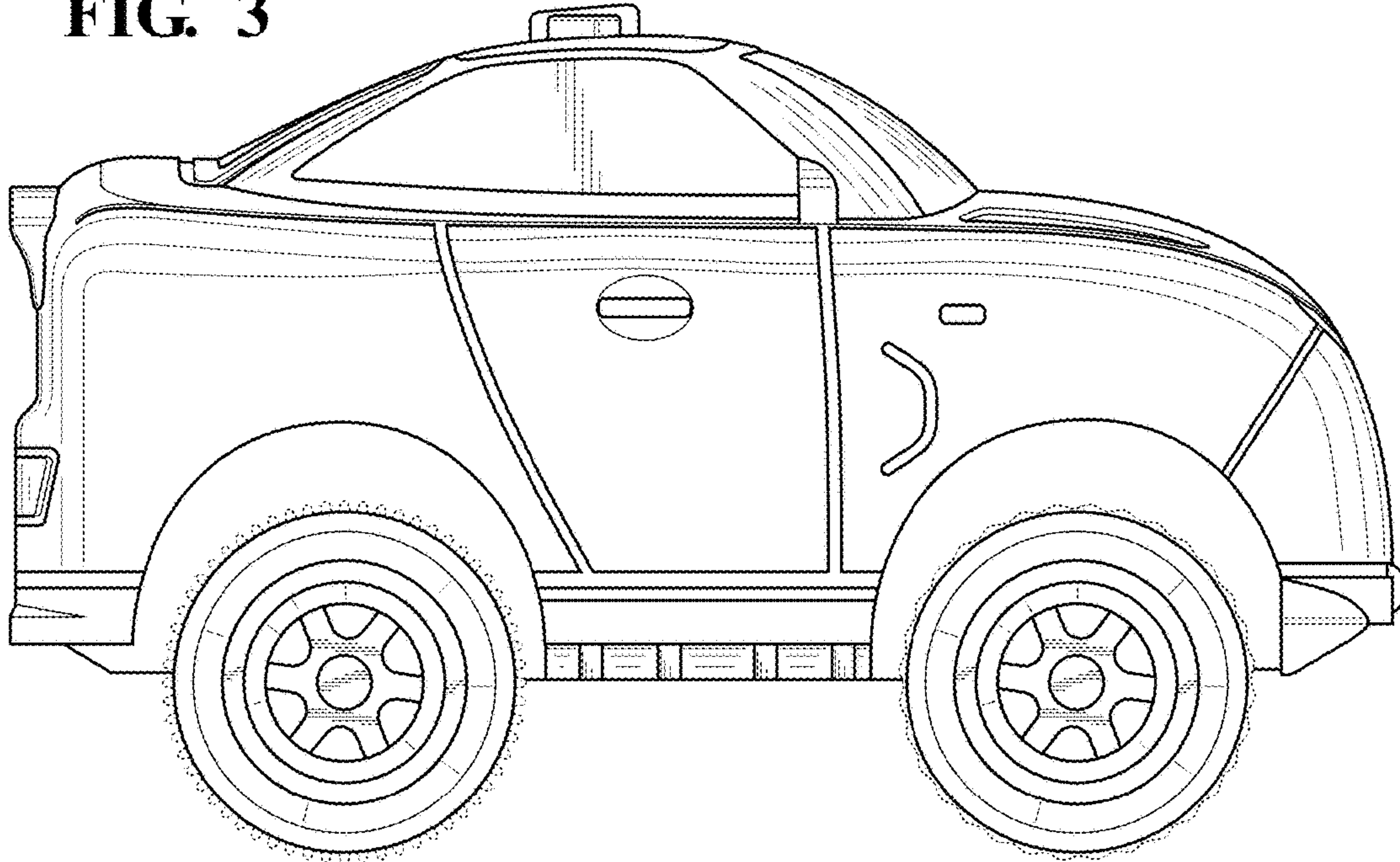


**FIG. 2**

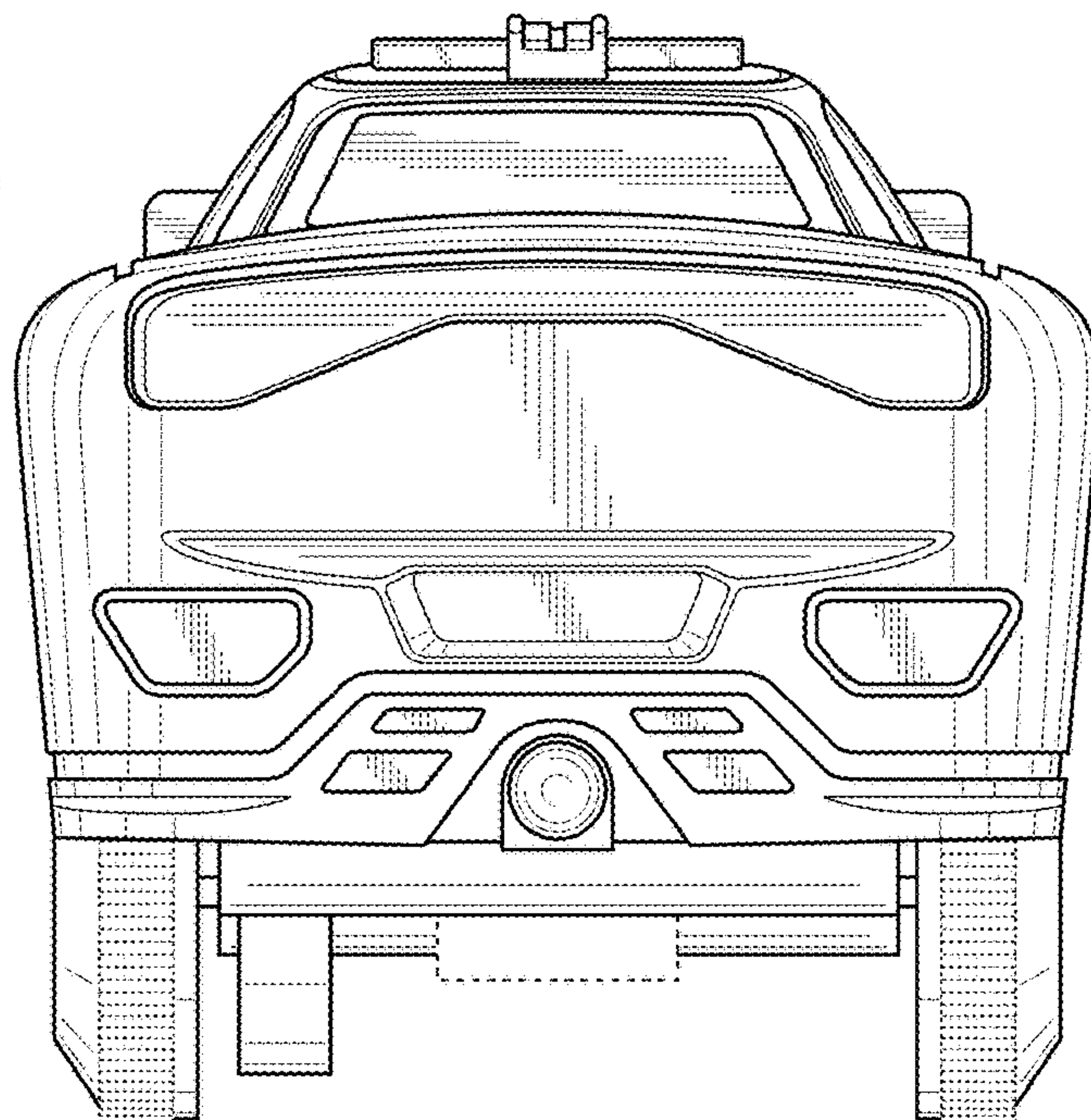




**FIG. 3**



**FIG. 4**



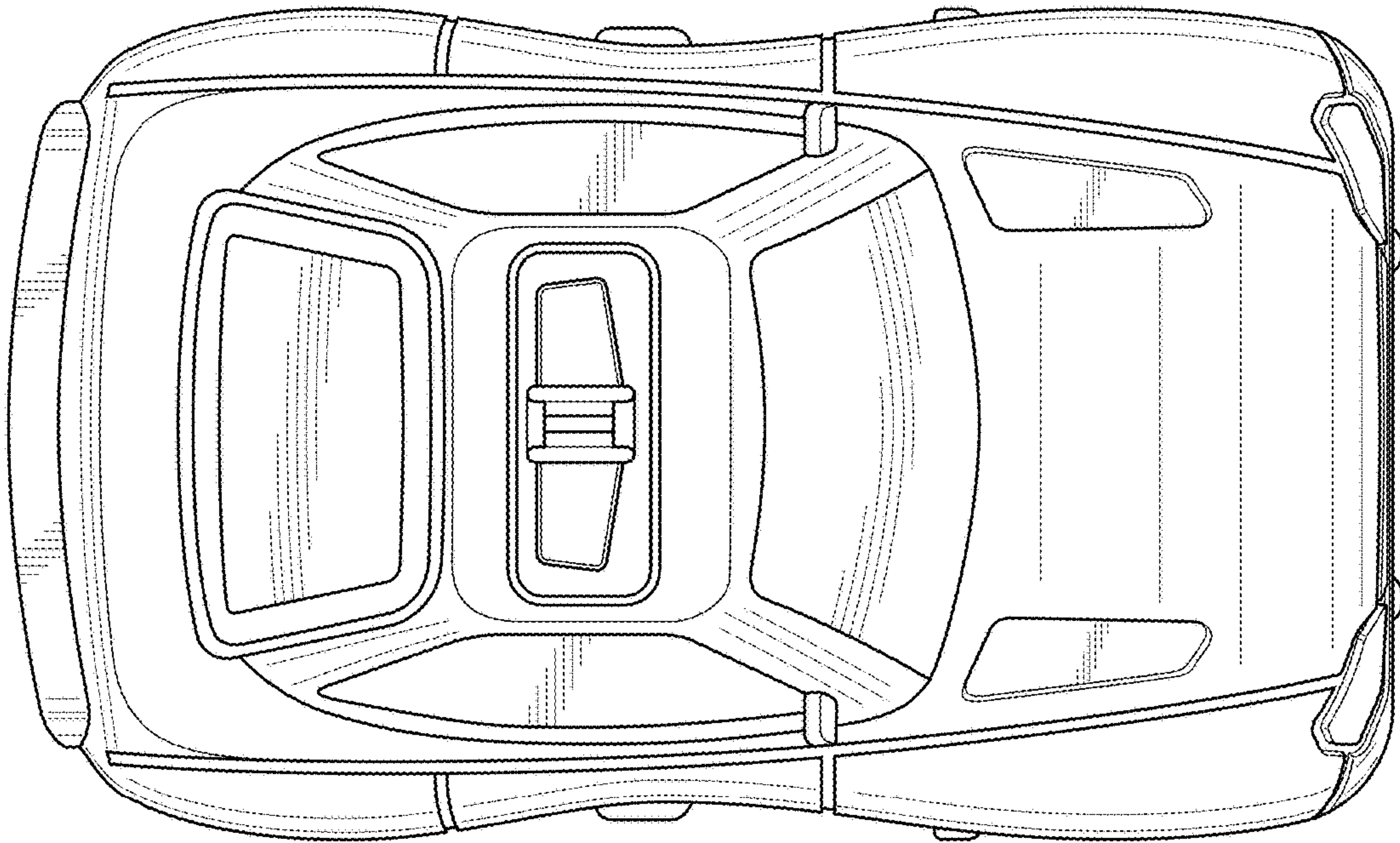


FIG. 5

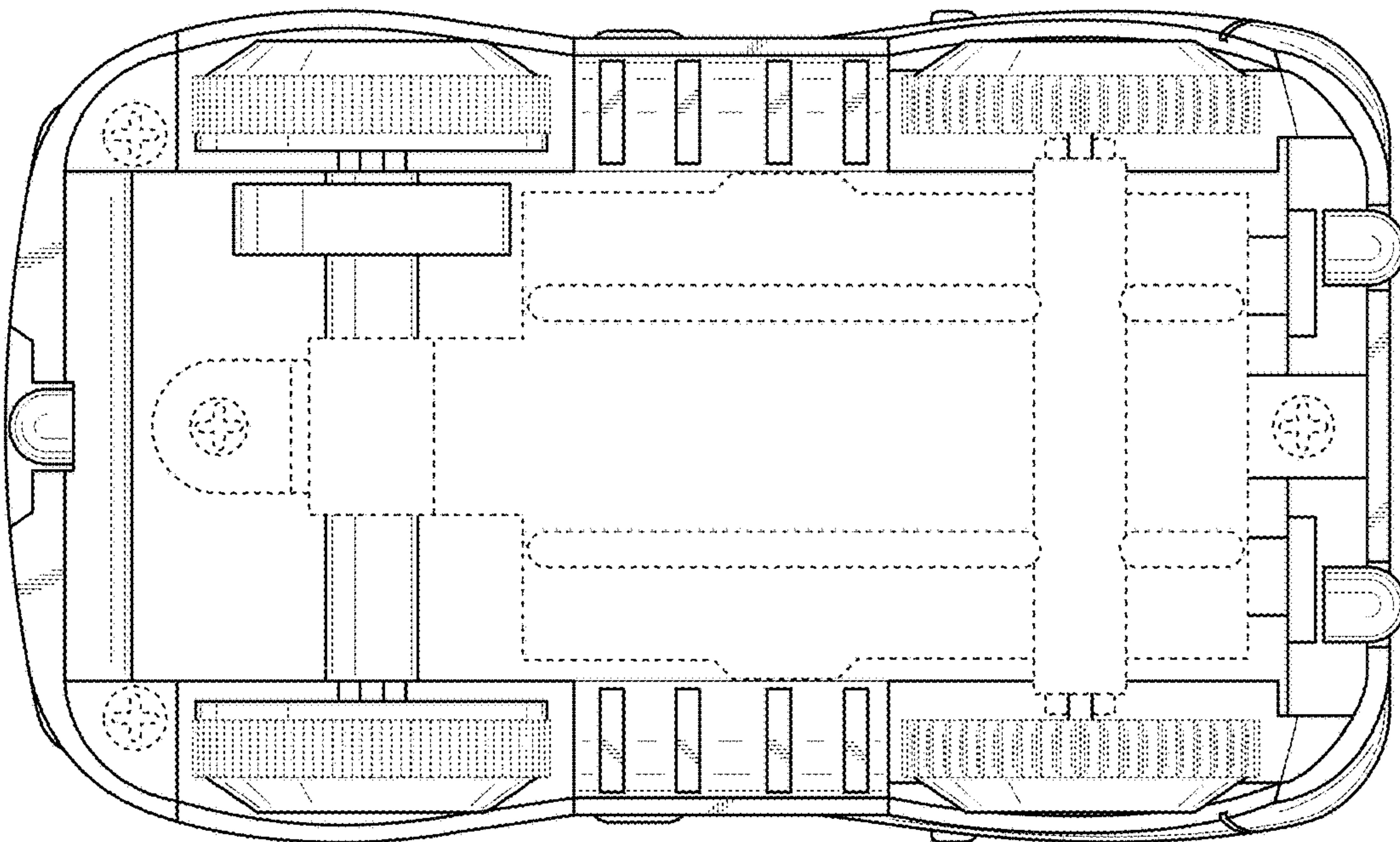


FIG. 6