



US00D835075S

(12) **United States Design Patent** (10) **Patent No.:** **US D835,075 S**
Maier et al. (45) **Date of Patent:** **** Dec. 4, 2018**

(54) **REMOTE CONTROL**

(71) Applicant: **FM MARKETING GMBH**, Neumarkt am Wallersee (AT)

(72) Inventors: **Ferdinand Maier**, Neumarkt am Wallersee (AT); **Erwin Weitgasser**, Salzburg (AT)

(73) Assignee: **fm marketing gmbh**, Neumarkt am Wallersee (AT)

(**) Term: **15 Years**

(21) Appl. No.: **35/503,513**

(22) Filed: **Jul. 25, 2017**

(80) **Hague Agreement Data**

Int. Filing Date: **Jul. 25, 2017**

Int. Reg. No.: **DM/097252**

Int. Reg. Date: **Jul. 25, 2017**

Int. Reg. Pub. Date: **Aug. 18, 2017**

(51) **LOC (11) Cl.** **14-03**

(52) **U.S. Cl.**
USPC **D14/218**

(58) **Field of Classification Search**
USPC D13/168; D14/324-333, 512, 516, 517;
D18/2.7

(Continued)

(56) **References Cited**

U.S. PATENT DOCUMENTS

D603,783 S * 11/2009 Carlton D12/501
D647,887 S * 11/2011 Dawson D14/218

(Continued)

Primary Examiner — Michael A. Pratt

(74) *Attorney, Agent, or Firm* — Stinson Leonard Street LLP

(57) **CLAIM**

The ornamental design for a remote control, as shown and described.

DESCRIPTION

4.-12. Remote control

- 4.1: Bottom
- 4.2: Rear
- 4.3: Top
- 4.4: Left
- 4.5: Right
- 4.6: Front
- 4.7: Perspective
- 5.1: Top
- 5.2: Right
- 5.3: Bottom
- 5.4: Left
- 5.5: Rear
- 5.6: Front
- 5.7: Perspective
- 6.1: Bottom
- 6.2: Top
- 6.3: Left
- 6.4: Rear
- 6.5: Right
- 6.6: Front
- 6.7: Perspective
- 7.1: Bottom
- 7.2: Top
- 7.3: Rear
- 7.4: Left
- 7.5: Right
- 7.6: Front
- 7.7: Perspective
- 8.1: Top
- 8.2: Bottom
- 8.3: Rear
- 8.4: Right
- 8.5: Left
- 8.6: Front
- 8.7: Perspective
- 9.1: Bottom

(Continued)

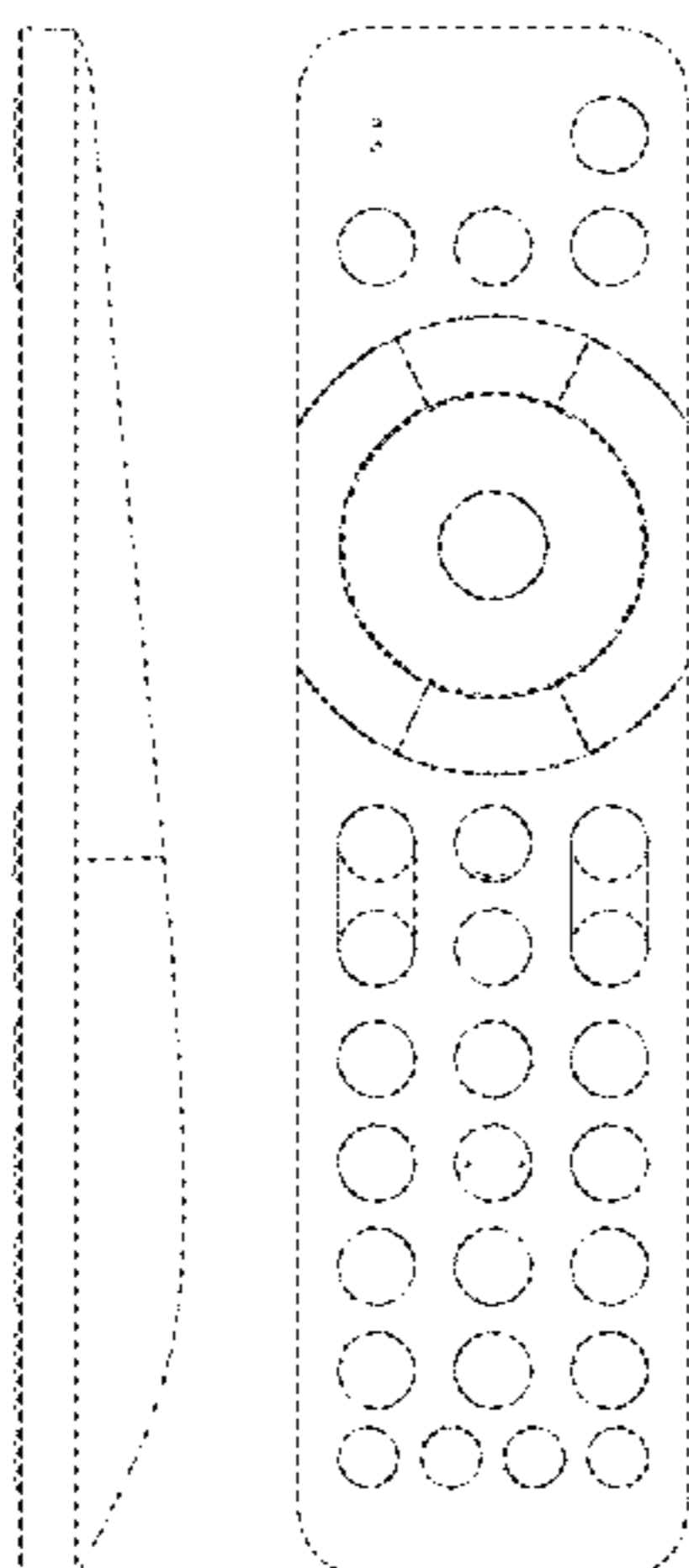

9.2: Top
9.3: Left
9.4: Right
9.5: Rear
9.6: Front
9.7: Perspective
10.1: Bottom
10.2: Left
10.3: Rear
10.4: Right
10.5: Top
10.6: Front
10.7: Perspective
11.1: Bottom
11.2: Left
11.3: Top
11.4: Rear
11.5: Right
11.6: Front
11.7: Perspective
12.1: Top
12.2: Bottom
12.3: Right

12.4: Rear
12.5: Left
12.6: Front
12.7: Perspective

1 Claim, 63 Drawing Sheets

(58) **Field of Classification Search**
CPC H04N 5/44; H04L 17/02; G08C 19/12
See application file for complete search history.

(56) **References Cited**

U.S. PATENT DOCUMENTS

D706,379	S	*	6/2014	Iannello	D22/108
D727,456	S	*	4/2015	Schefter	D22/108
D735,831	S	*	8/2015	Faifer	D22/108
D803,815	S	*	11/2017	Maier	D14/218
D808,877	S	*	1/2018	Liu	D12/204
D809,485	S	*	2/2018	McManigal	D14/218
D818,457	S	*	5/2018	Paschke	D14/218

* cited by examiner

4.1

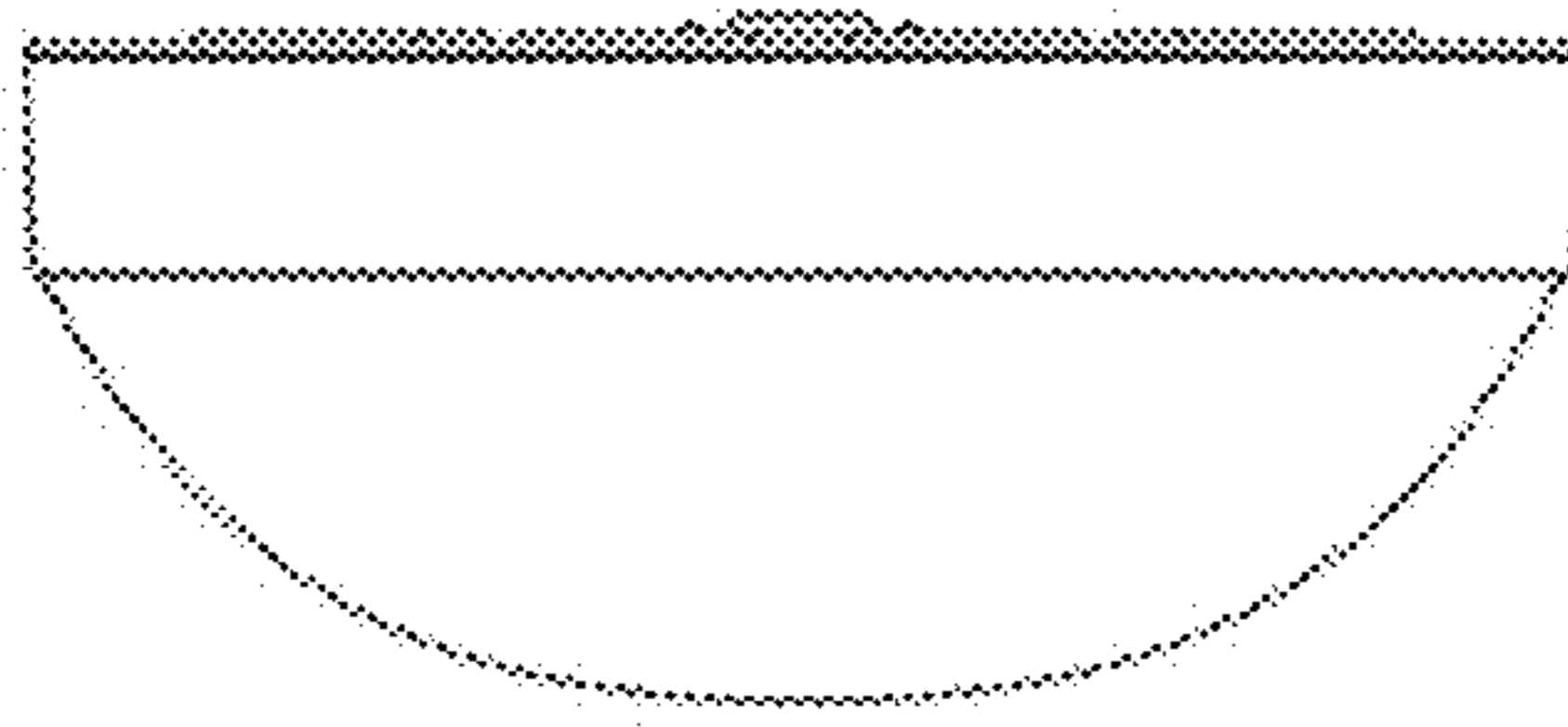

4.2

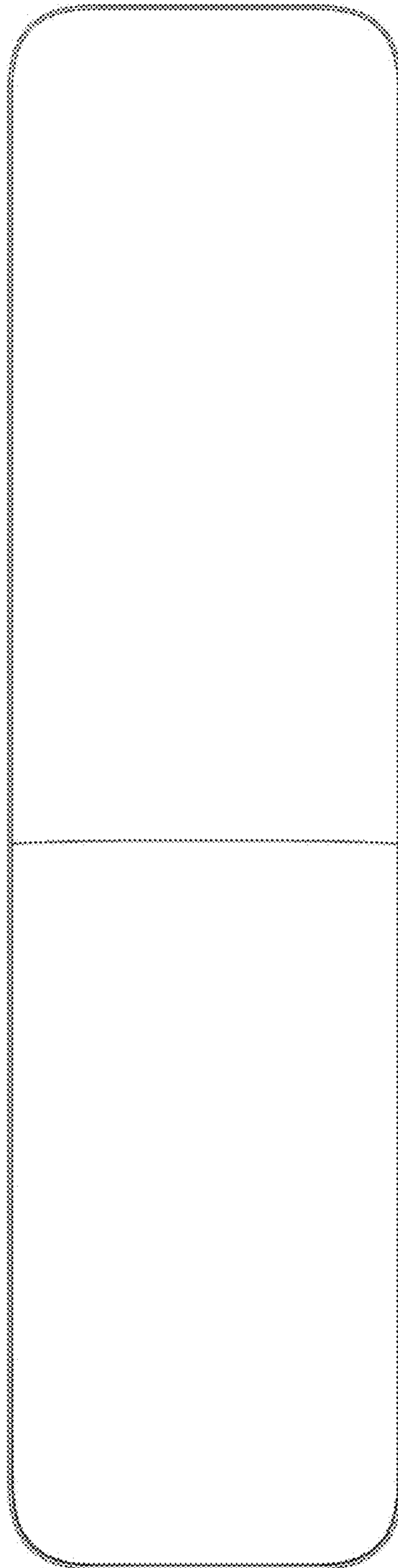

4.3

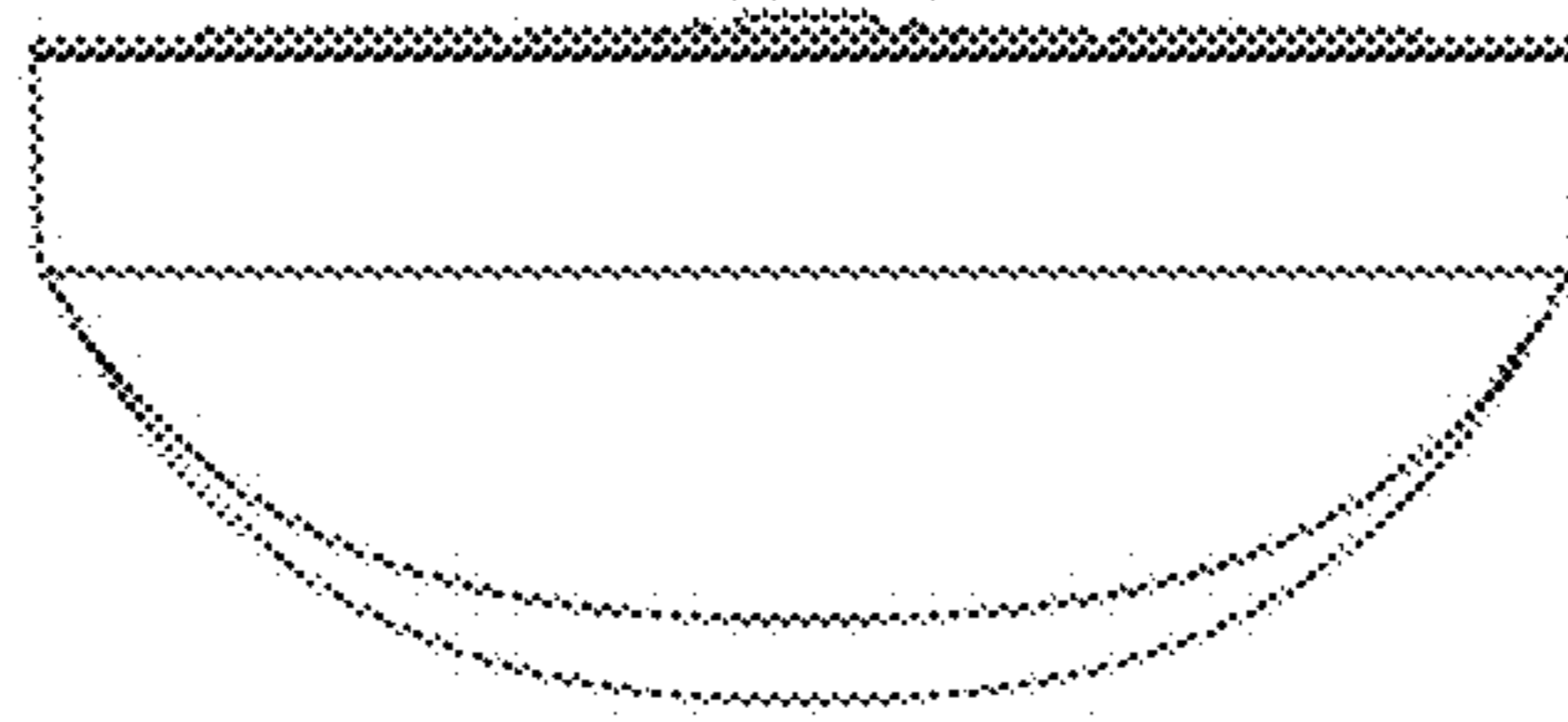

4.4

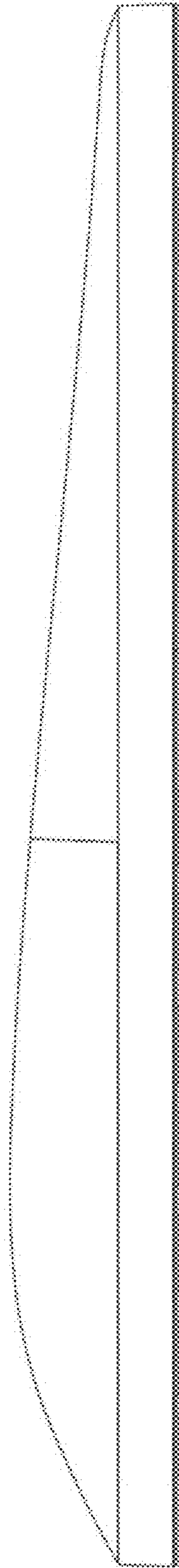

4.5

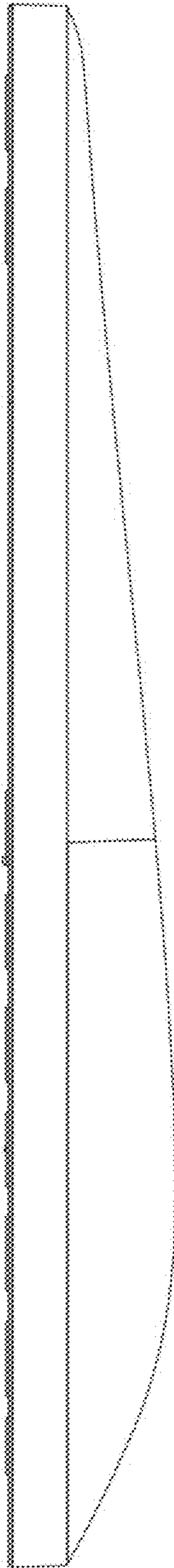

4.6

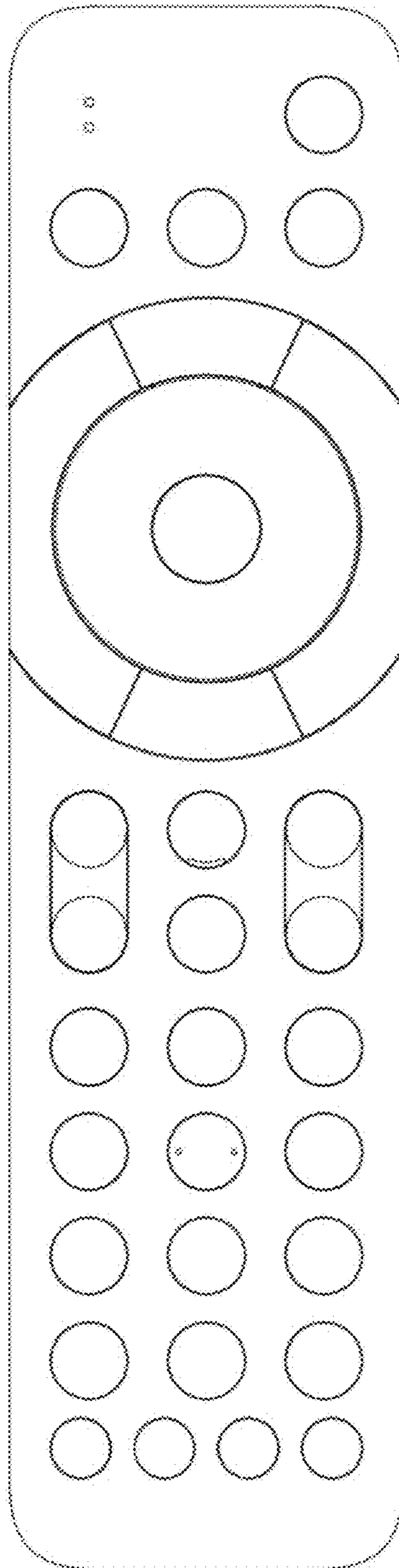

4.7

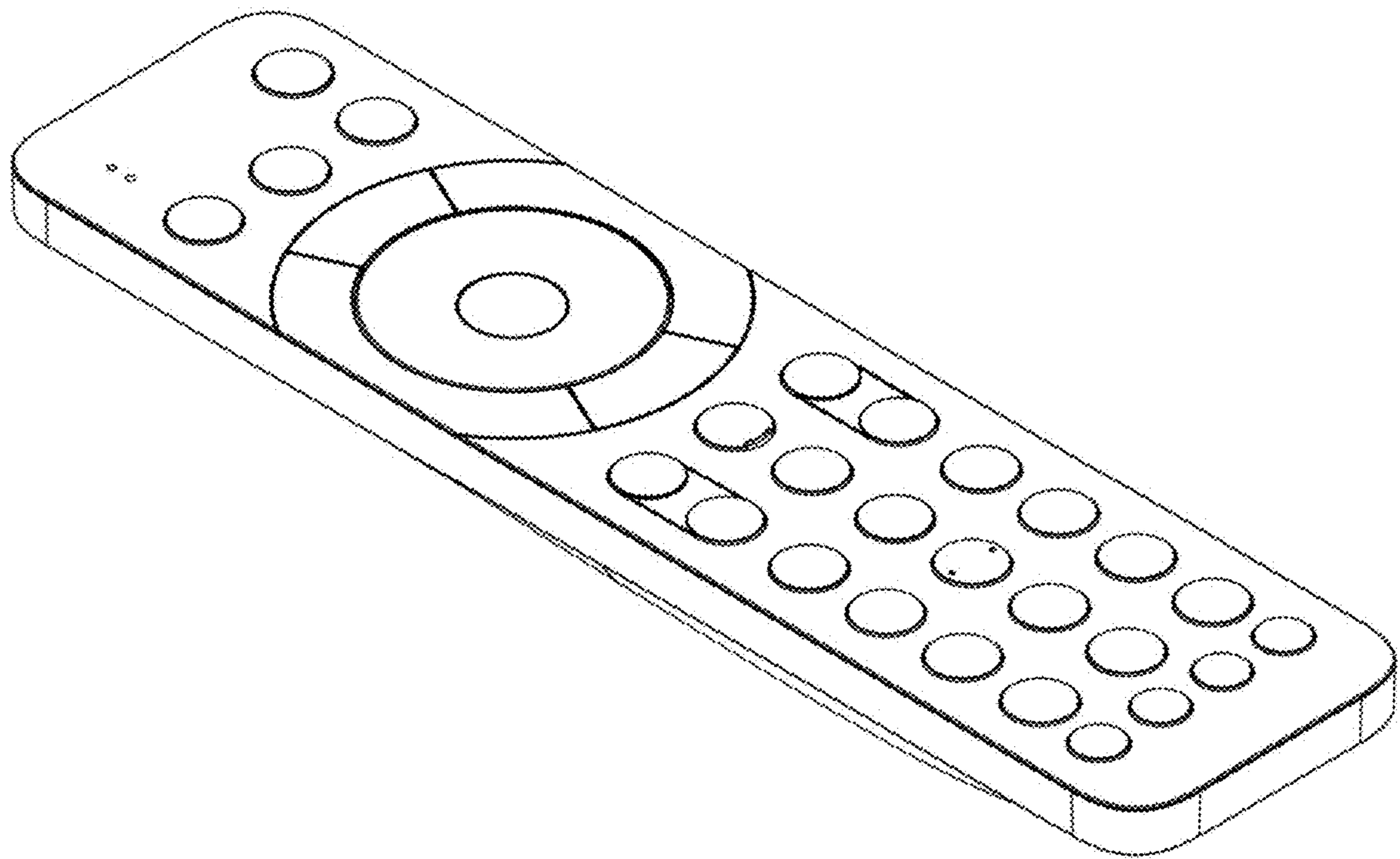

5.1

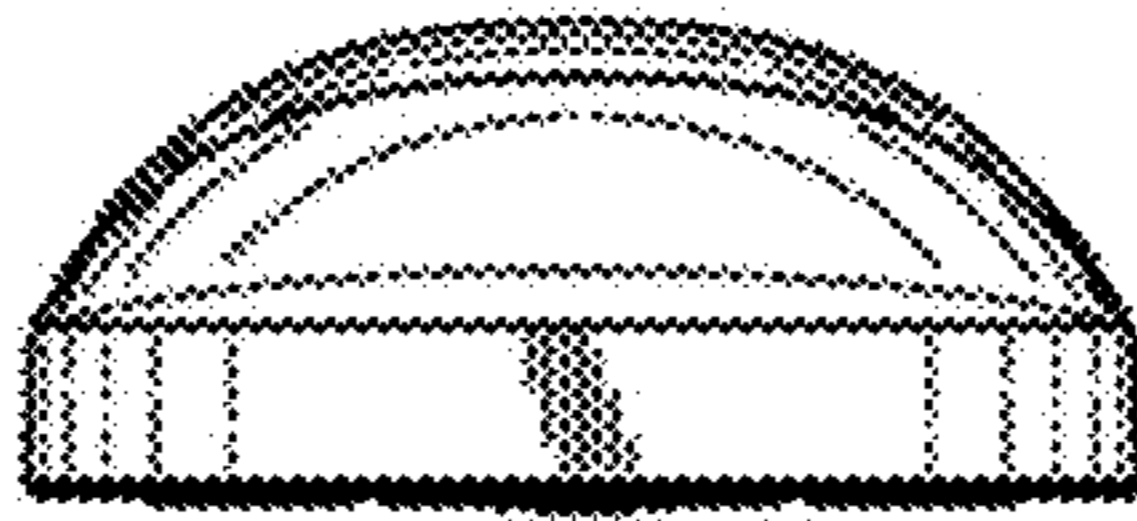

5.2

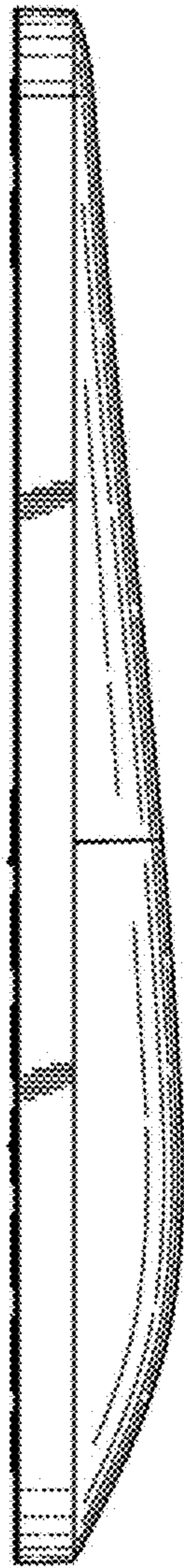

5.3



5.4

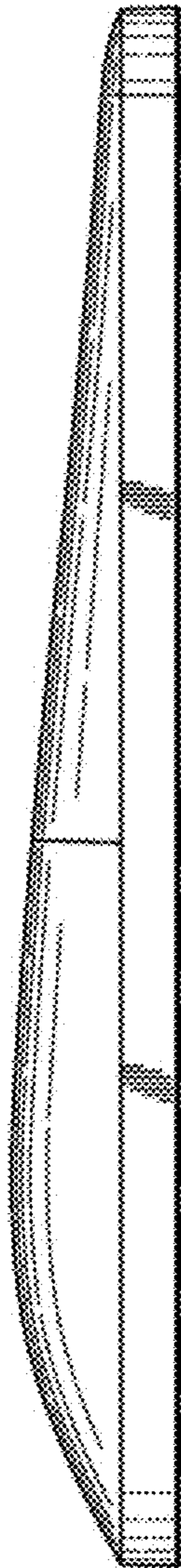

5.5

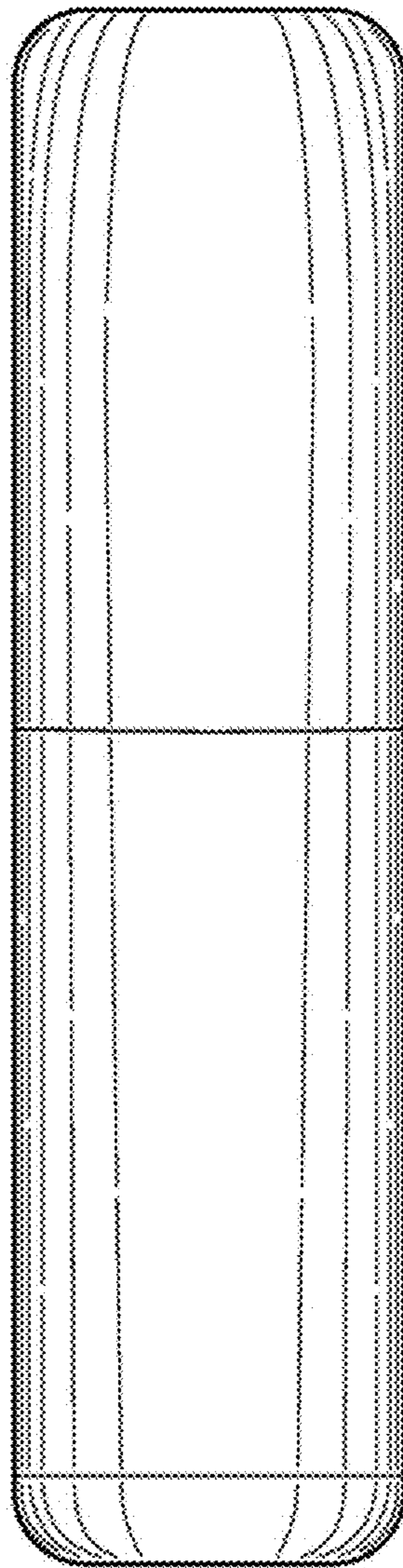

5.6

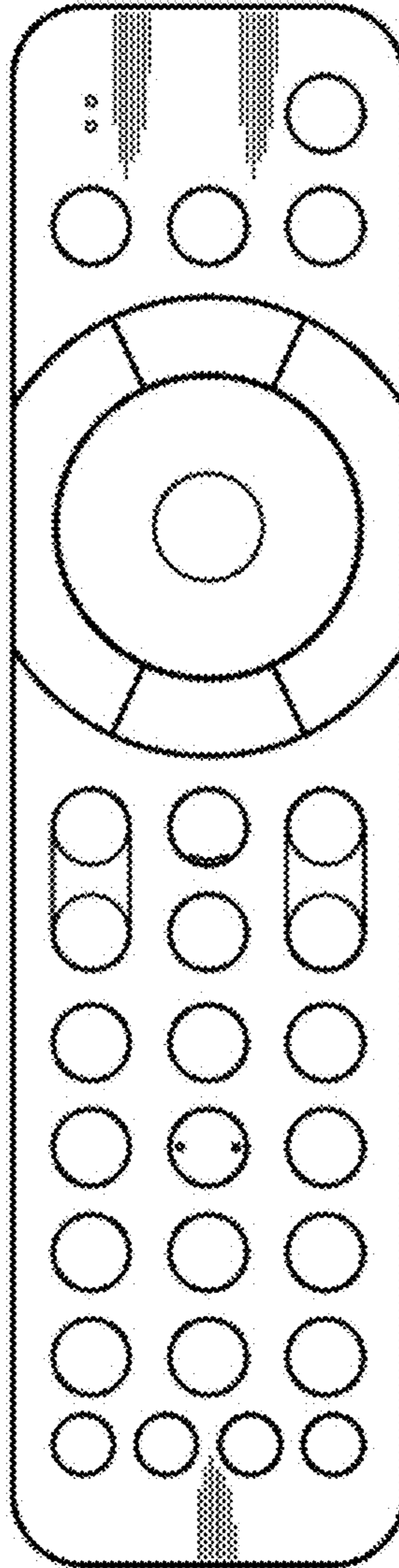

5.7

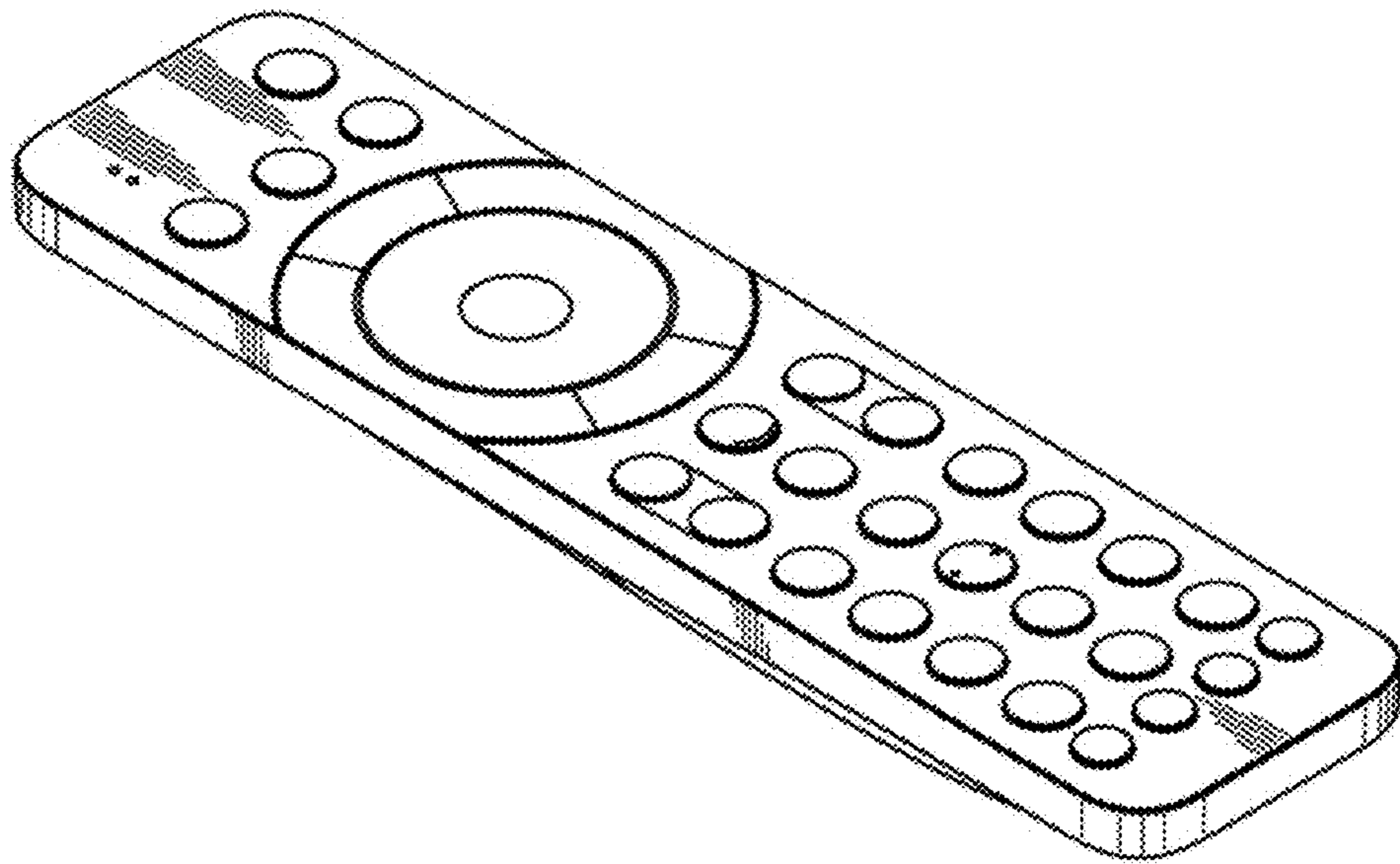

6.1

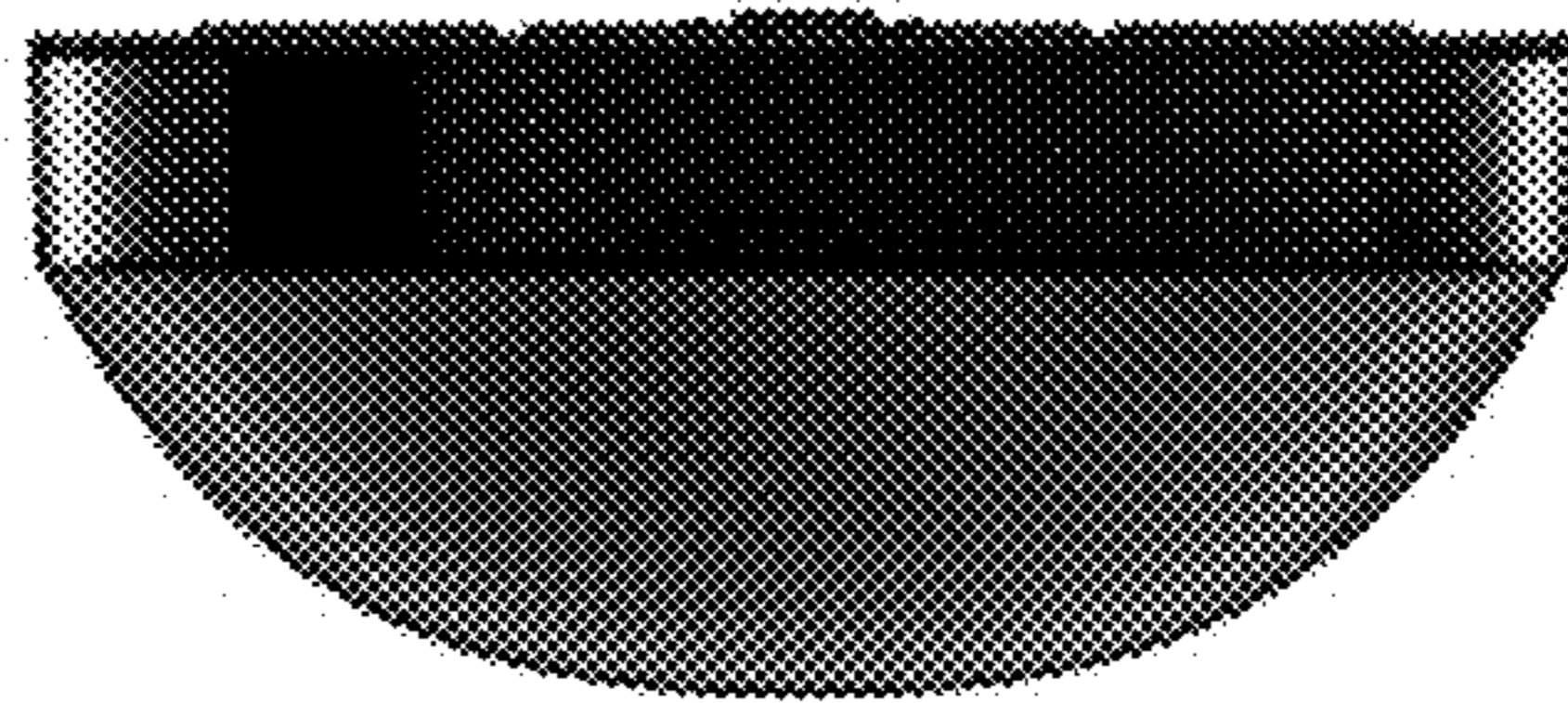

6.2

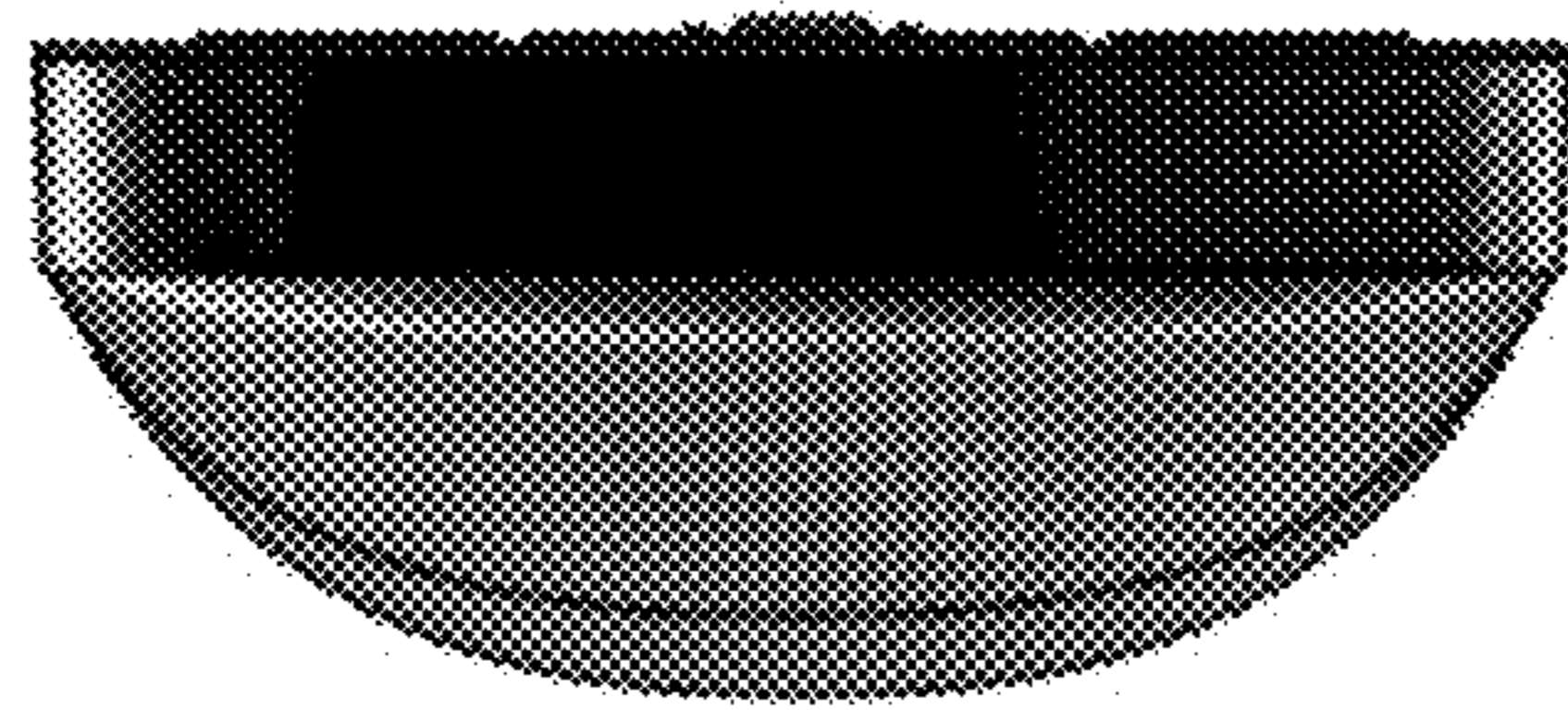

6.3

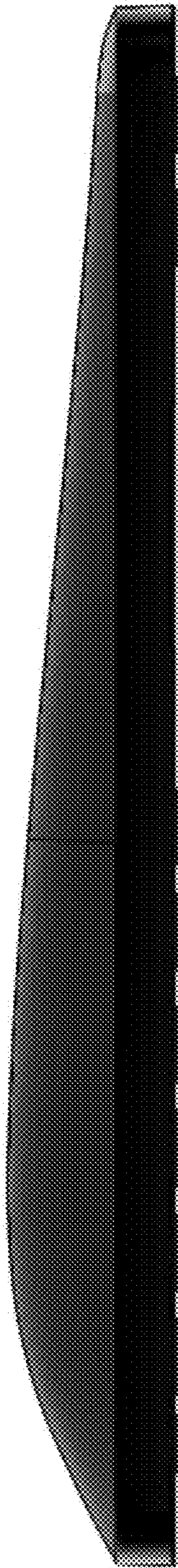

6.4

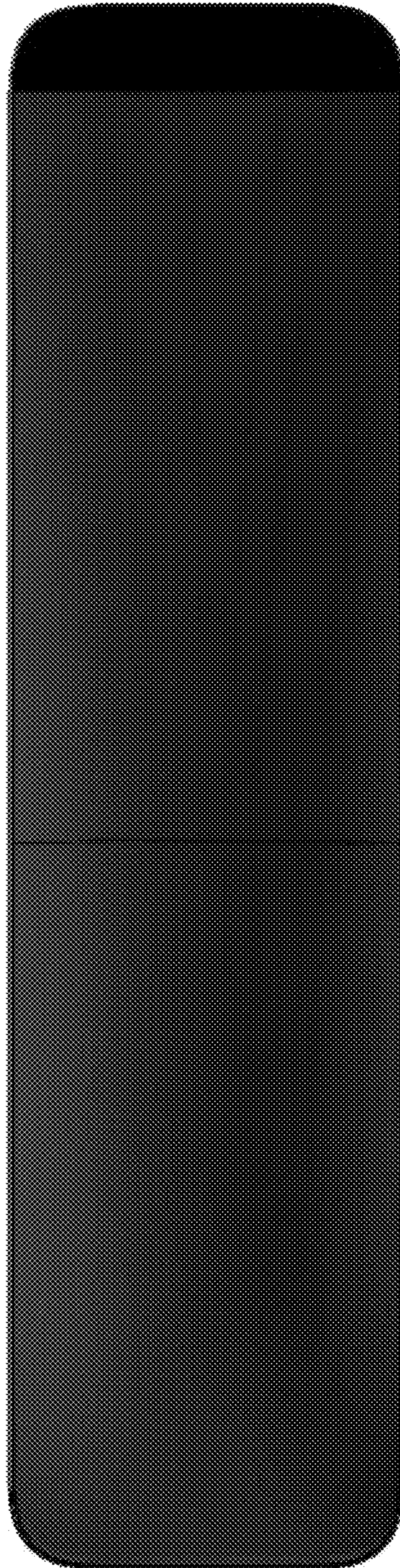

6.5

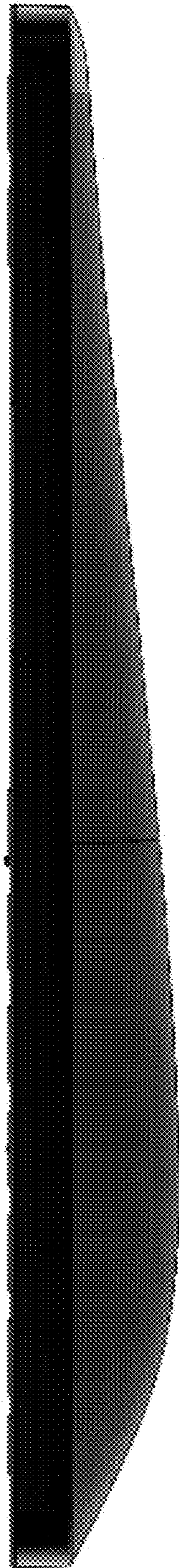

6.6

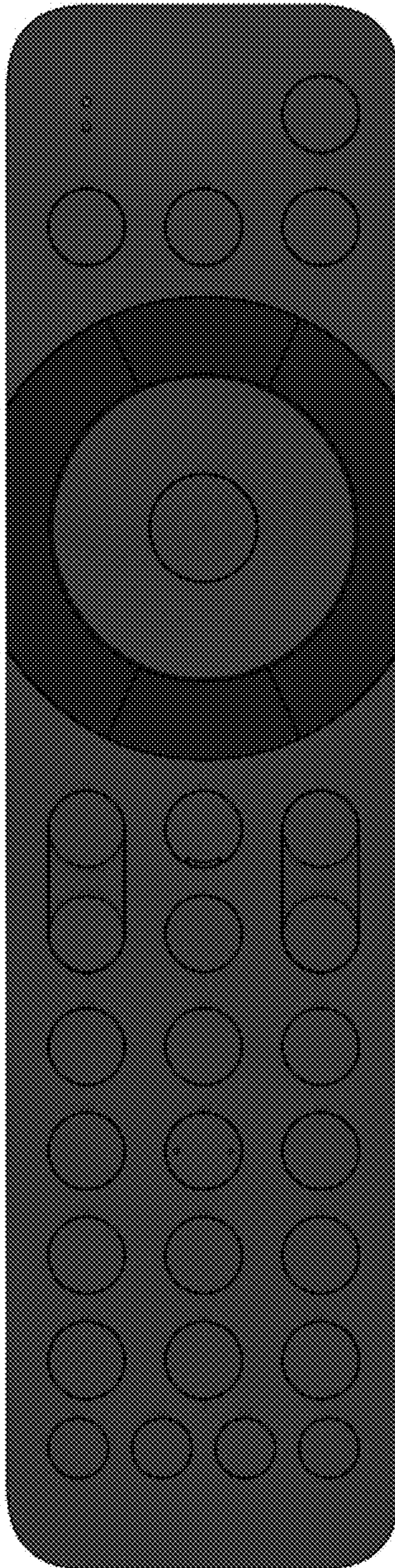

6.7

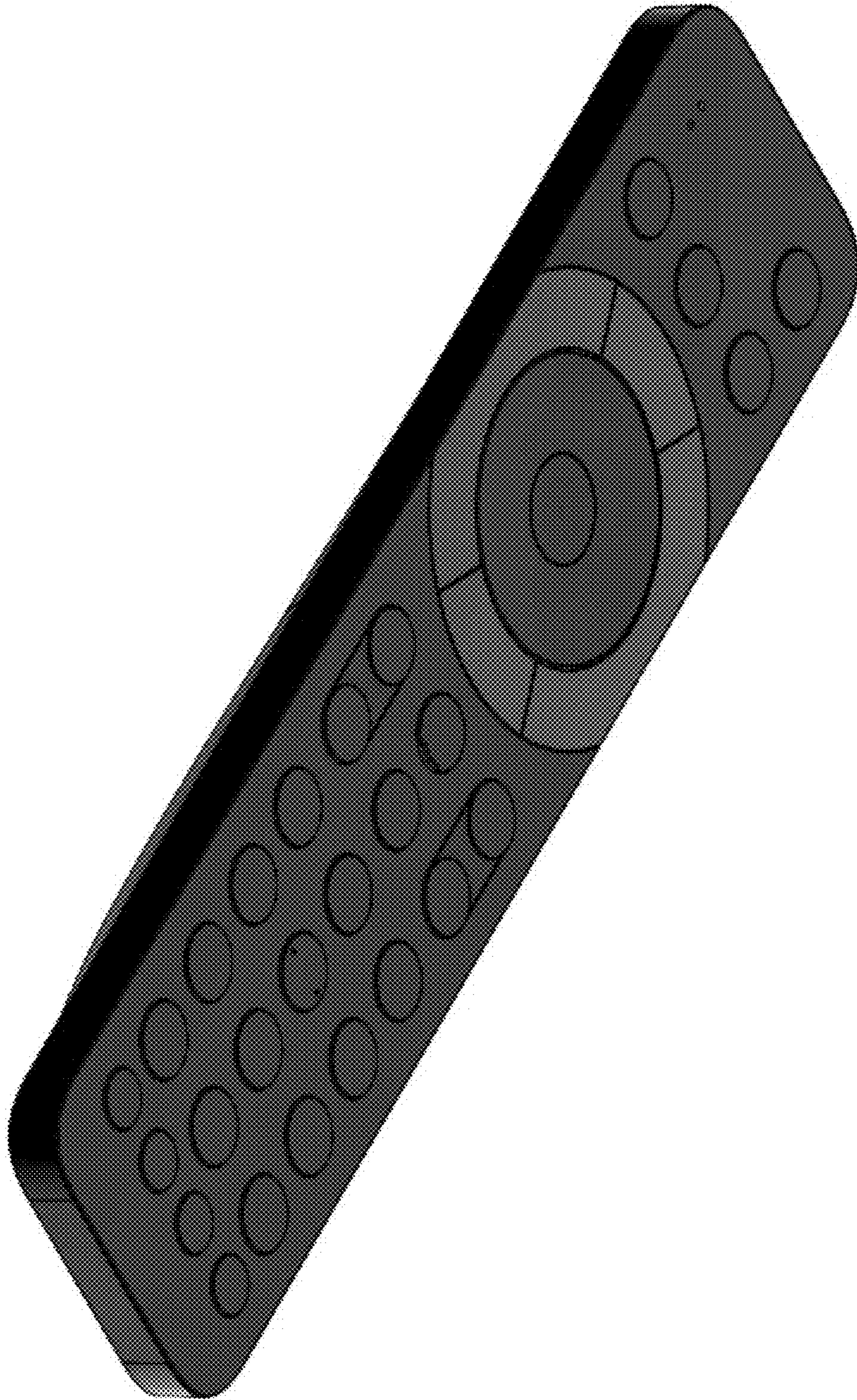

7.1

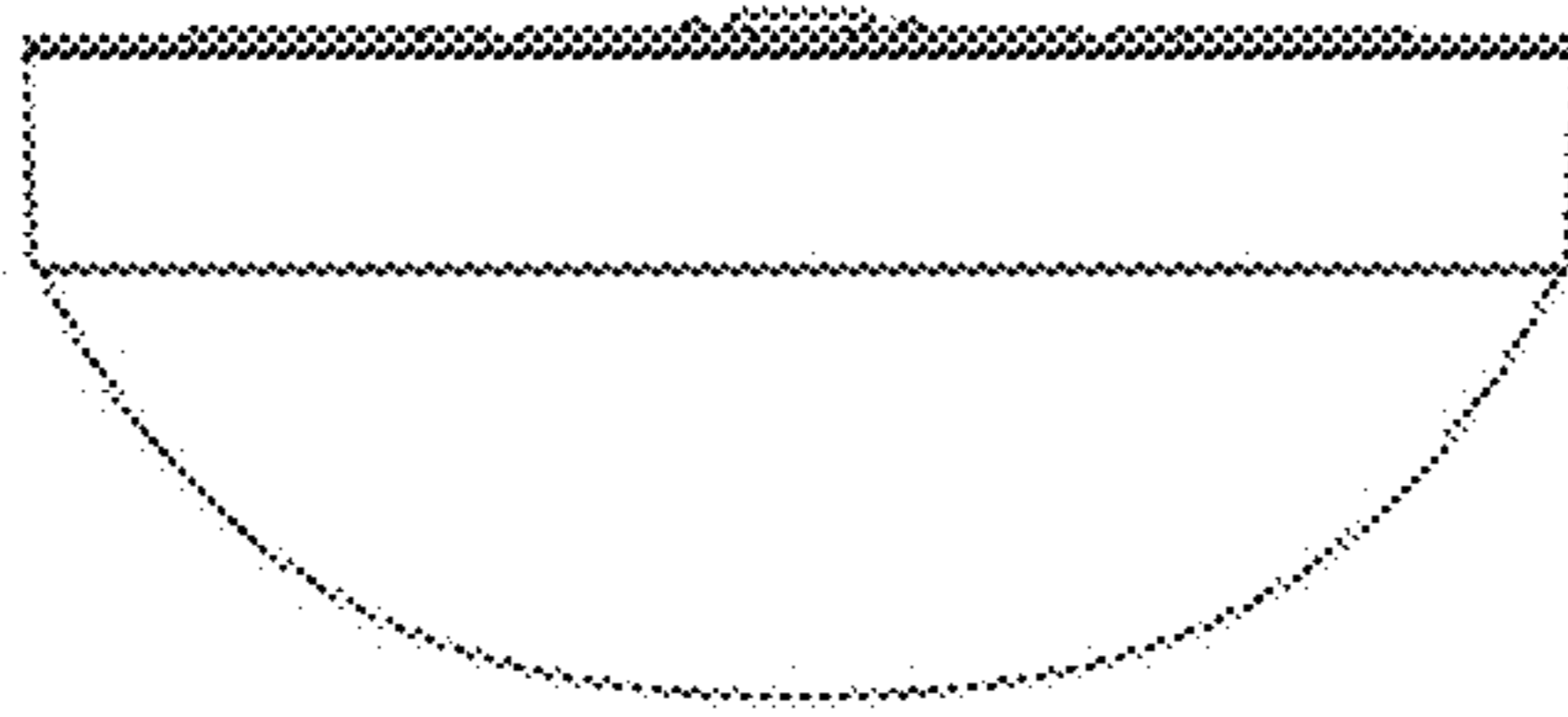

7.2

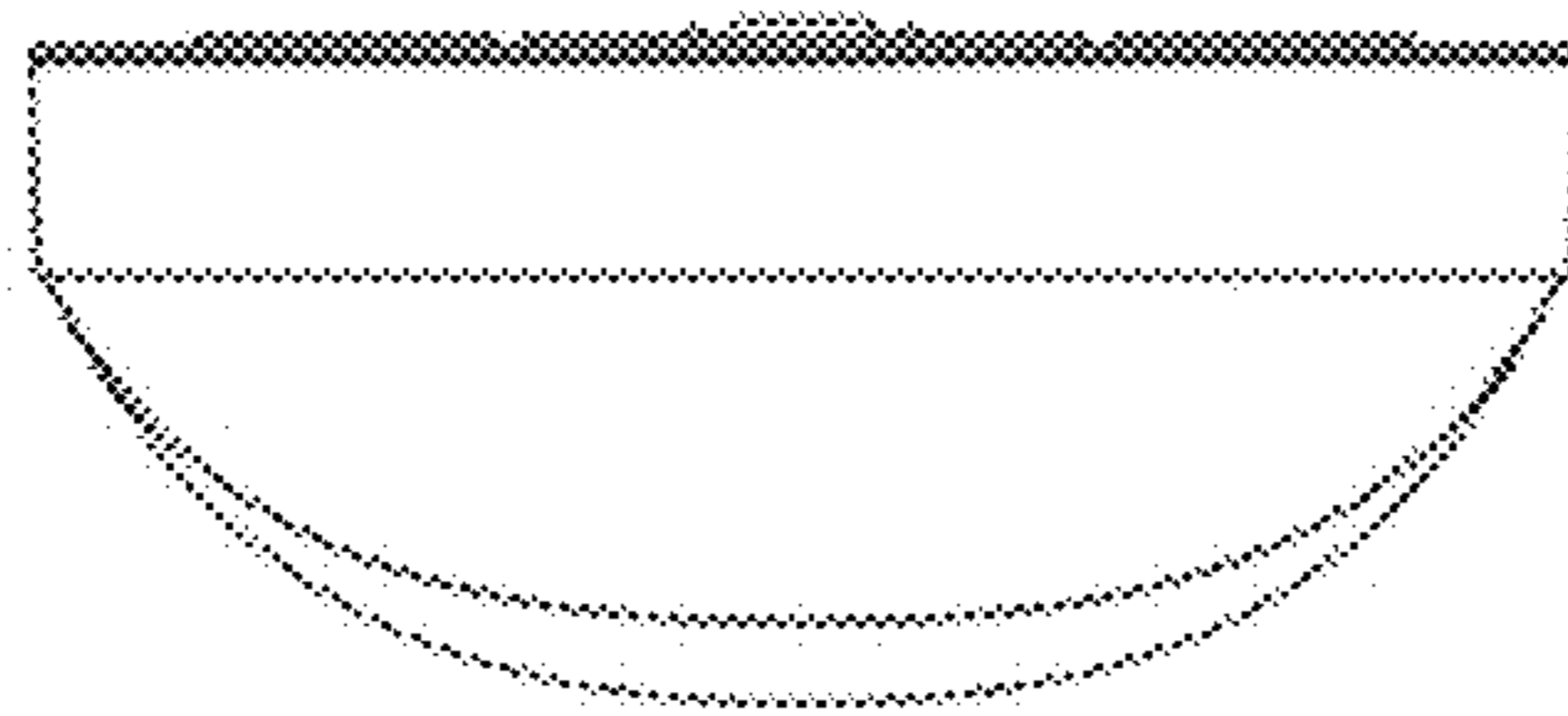

7.3

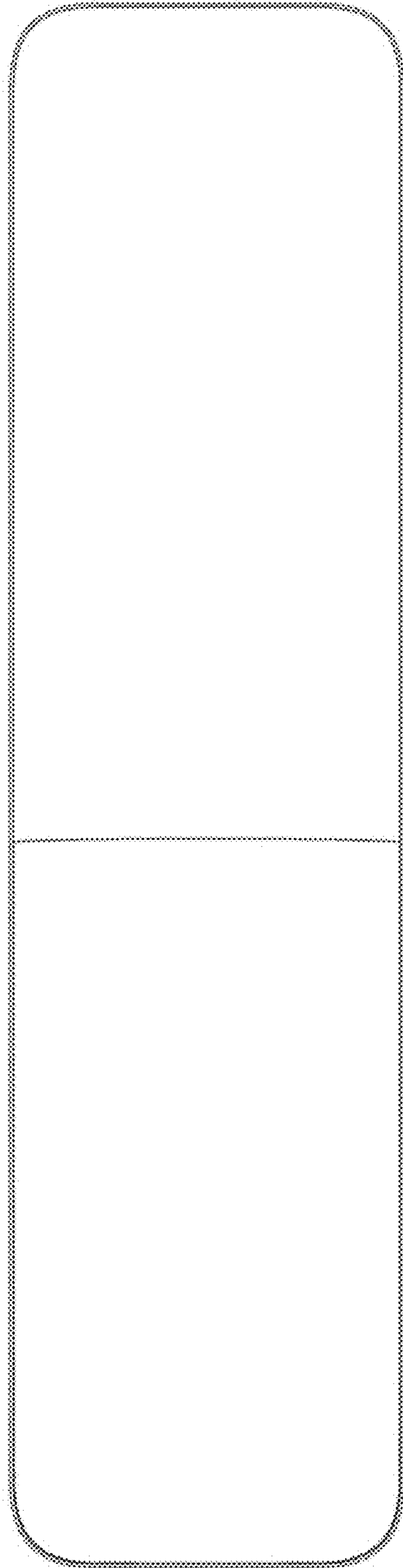

7.4

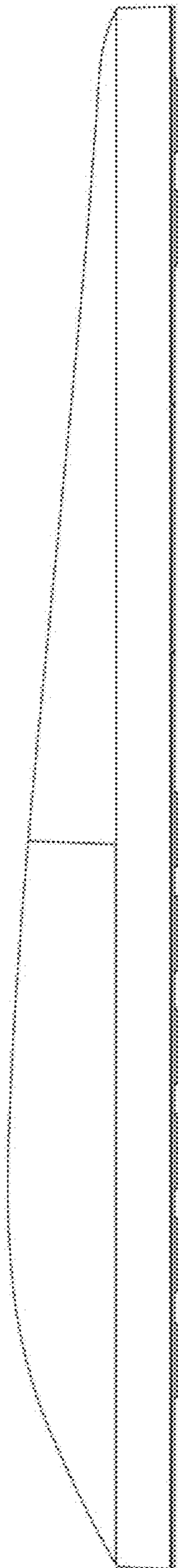

7.5

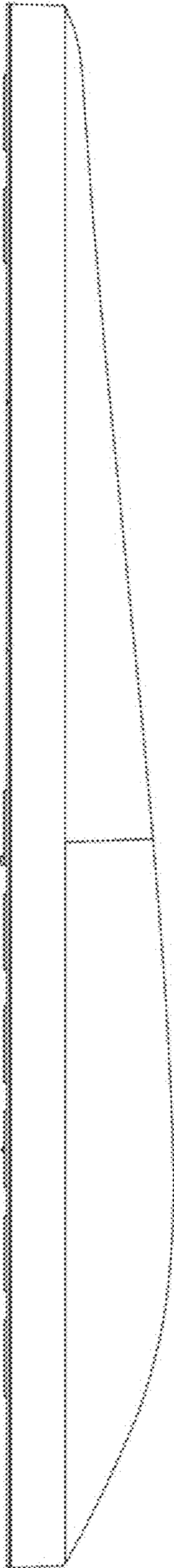

7.6

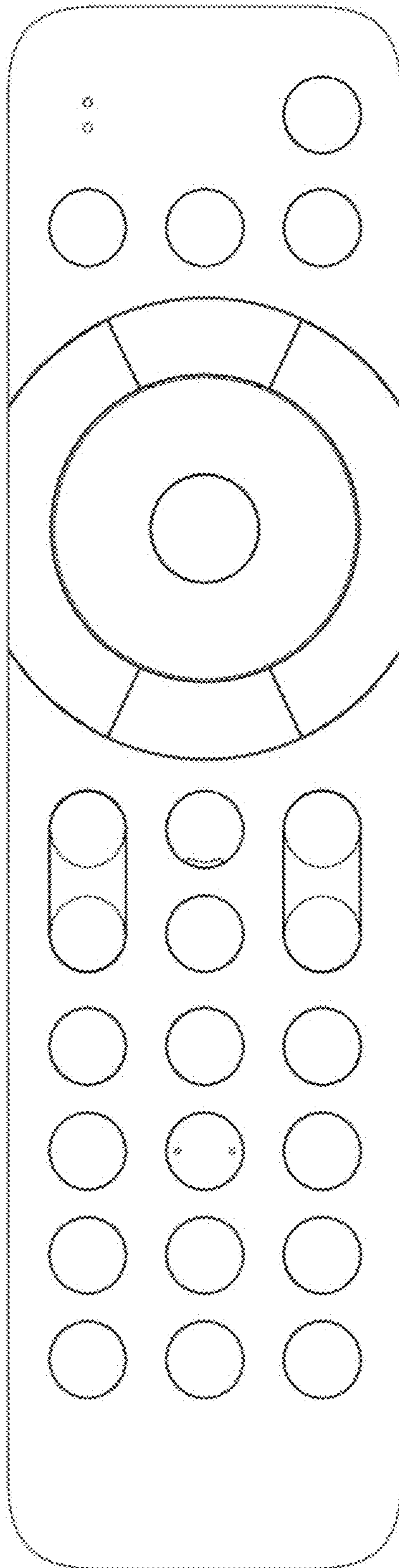

7.7

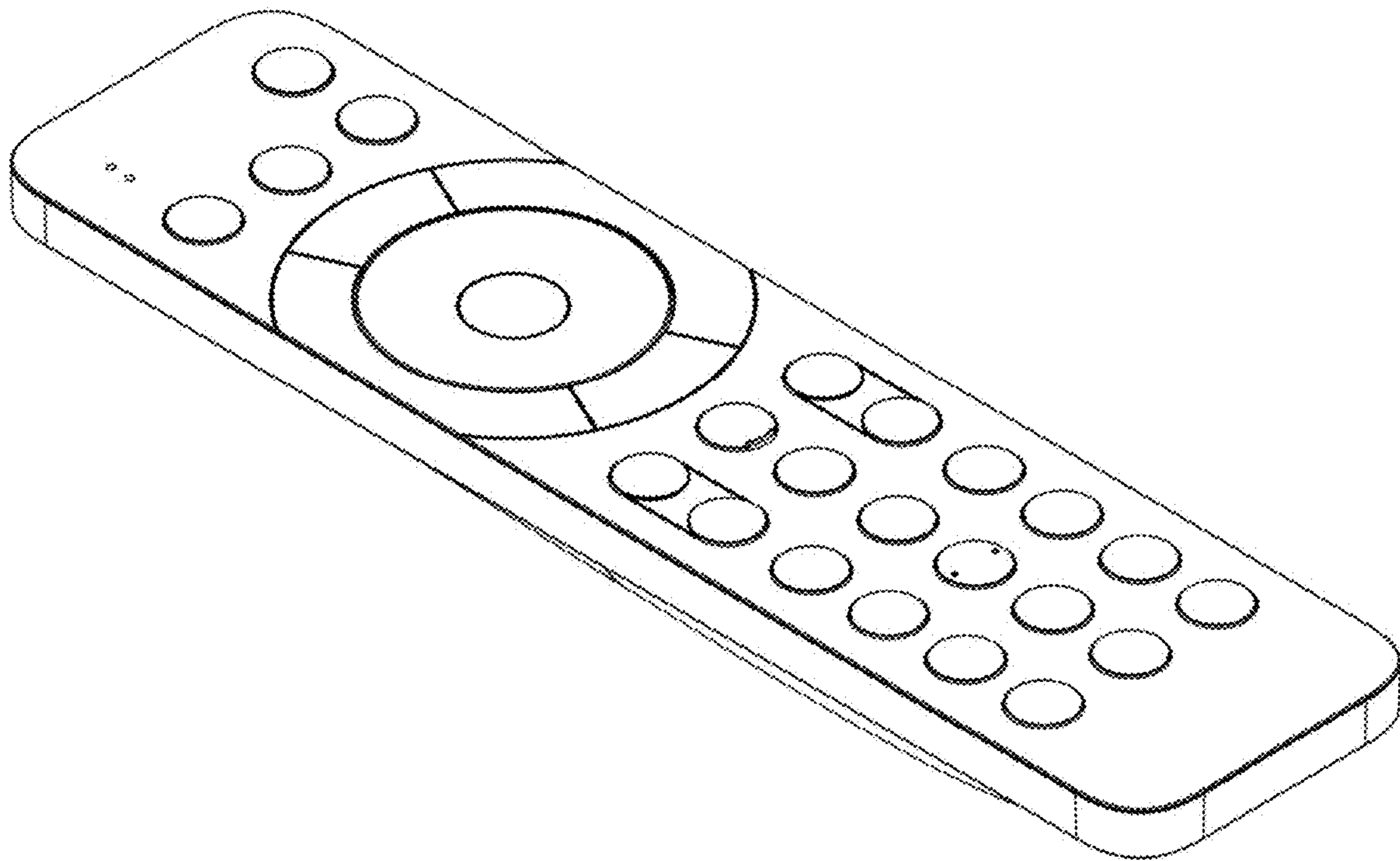

8.1



8.2



8.3

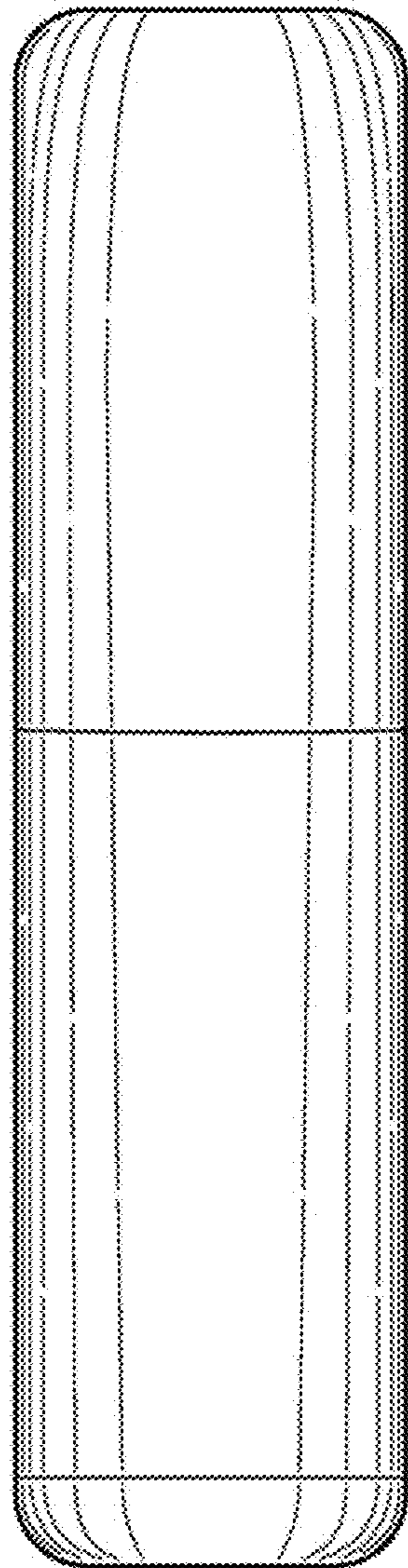

8.4

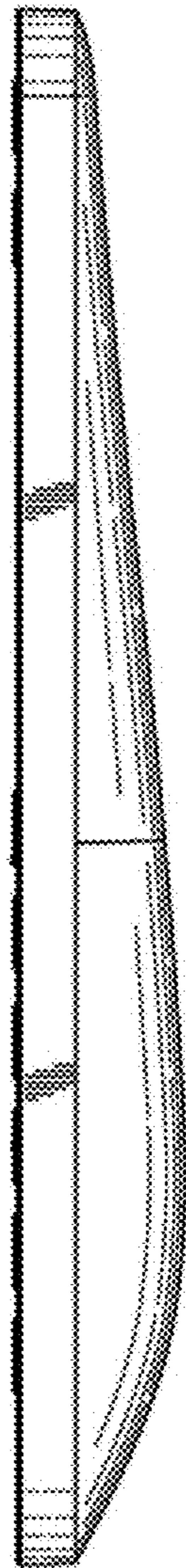

8.5

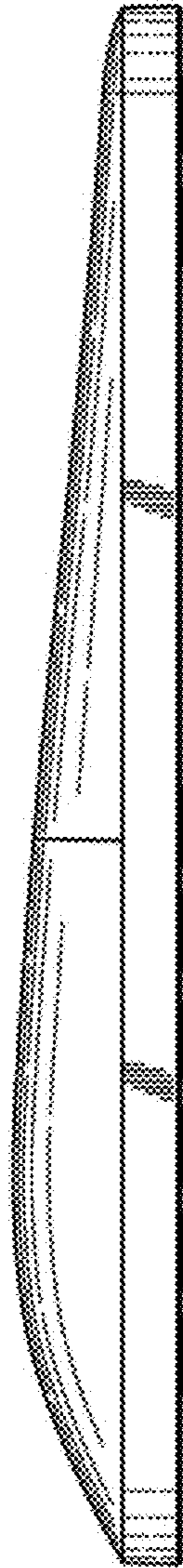

8.6

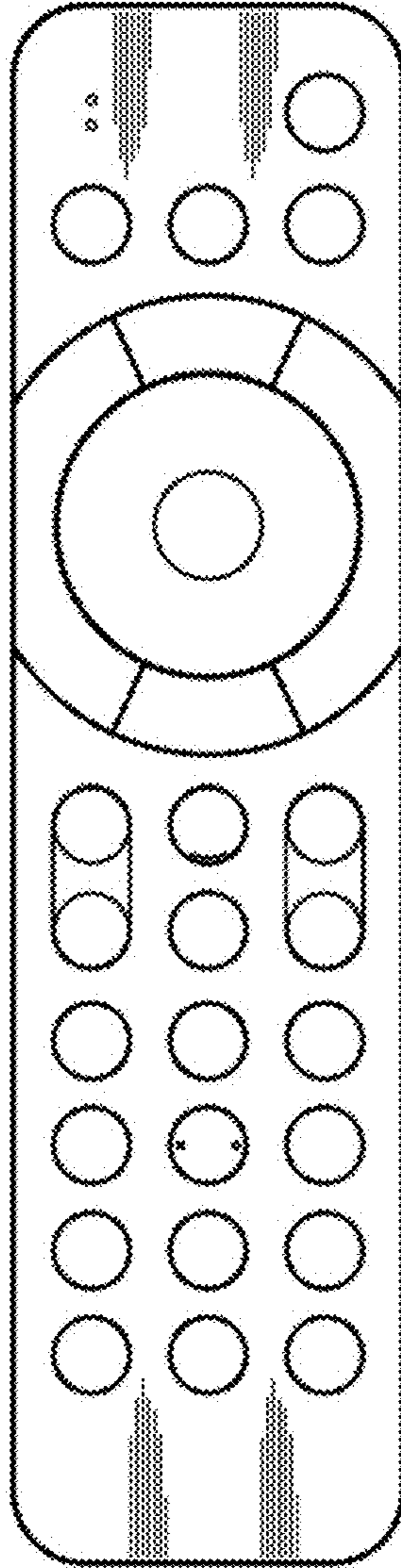

8.7

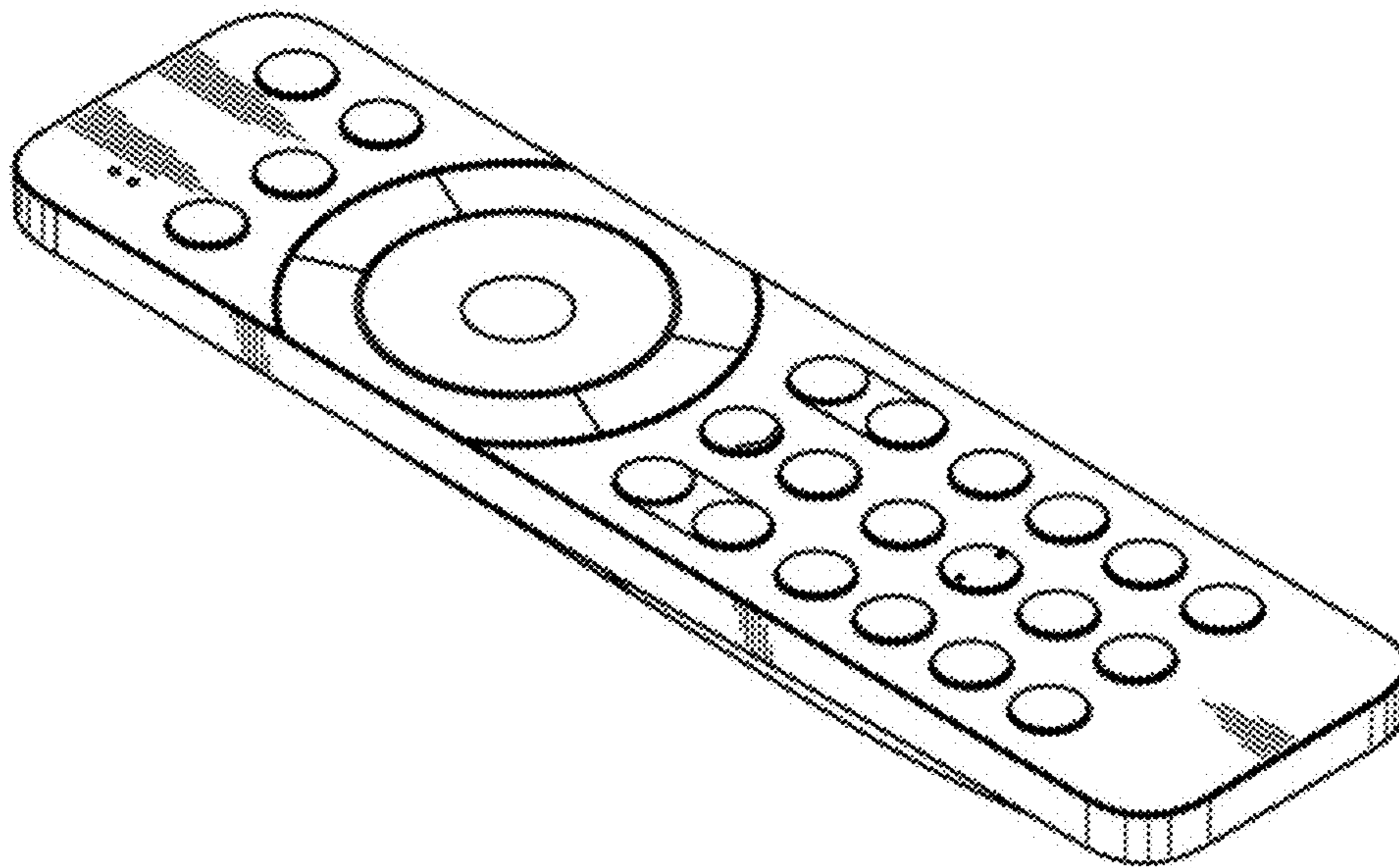

9.1

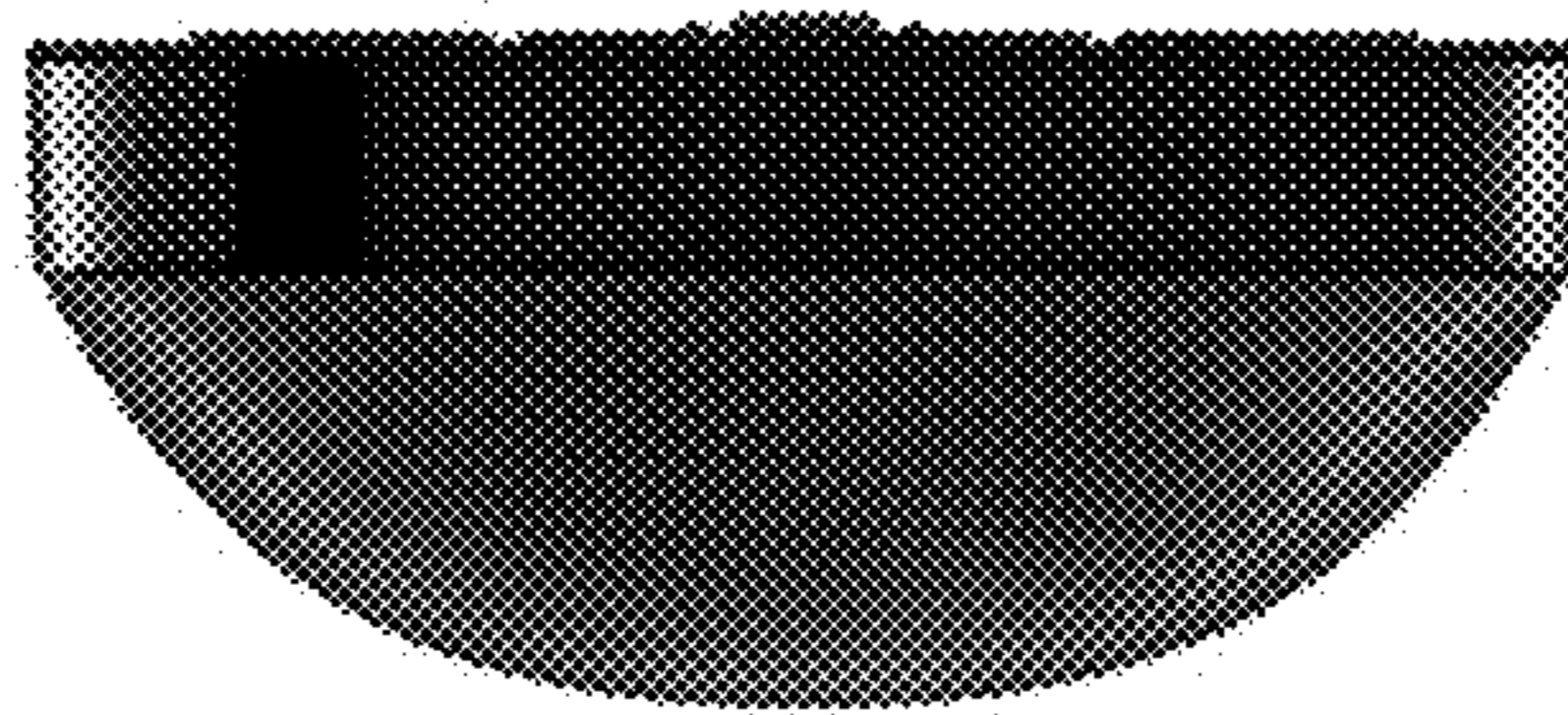

9.2

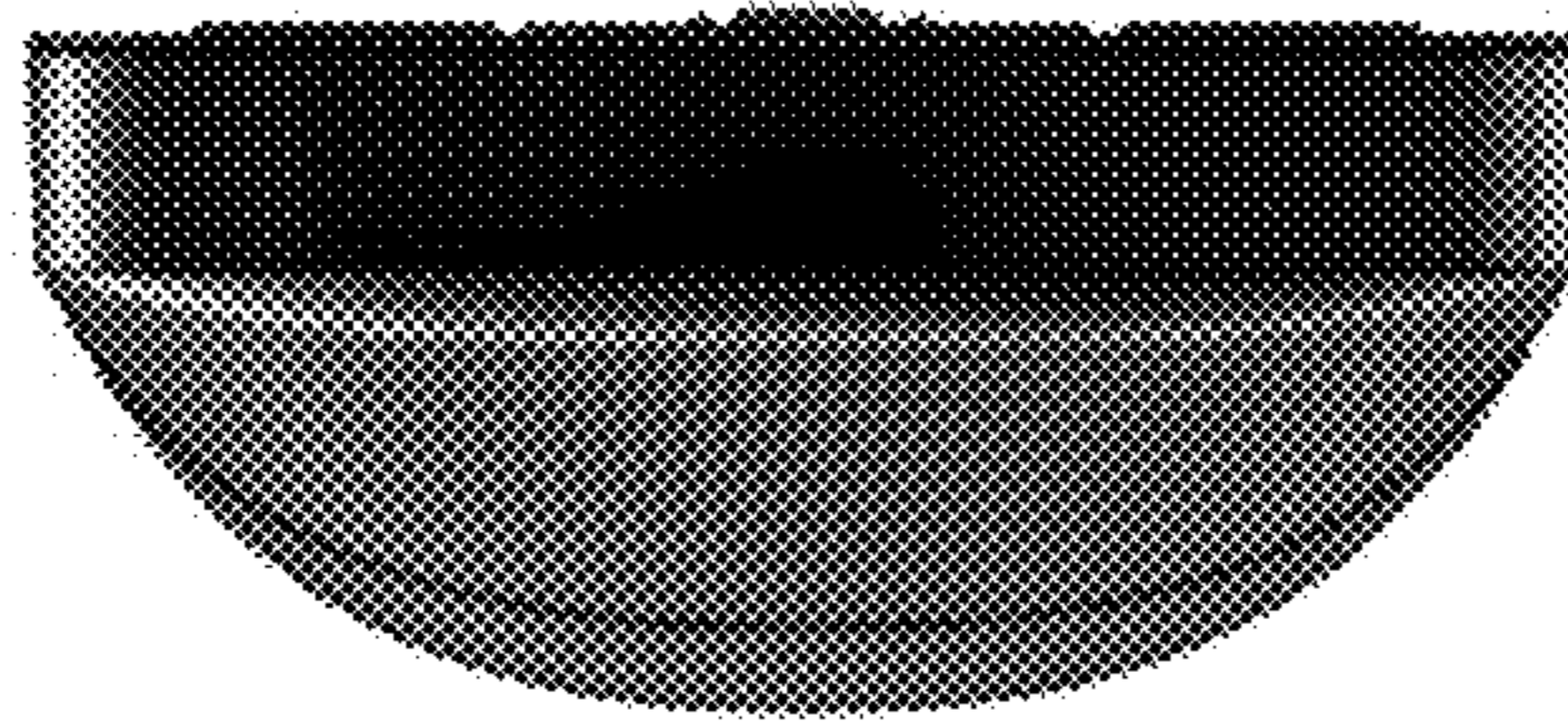

9.3

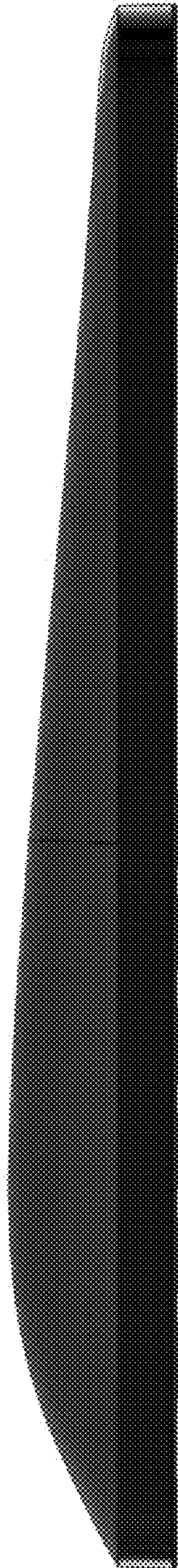

9.4

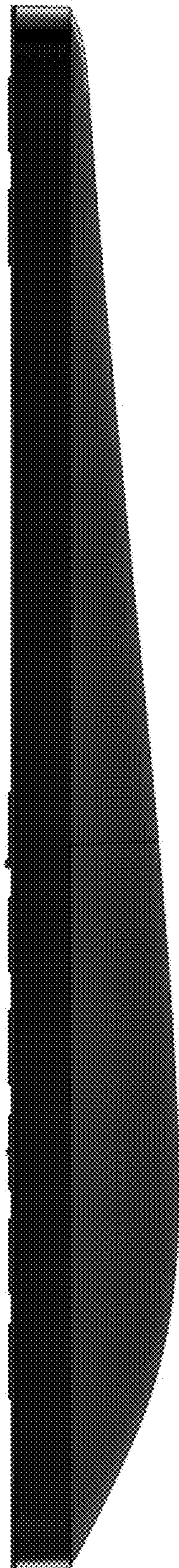

9.5

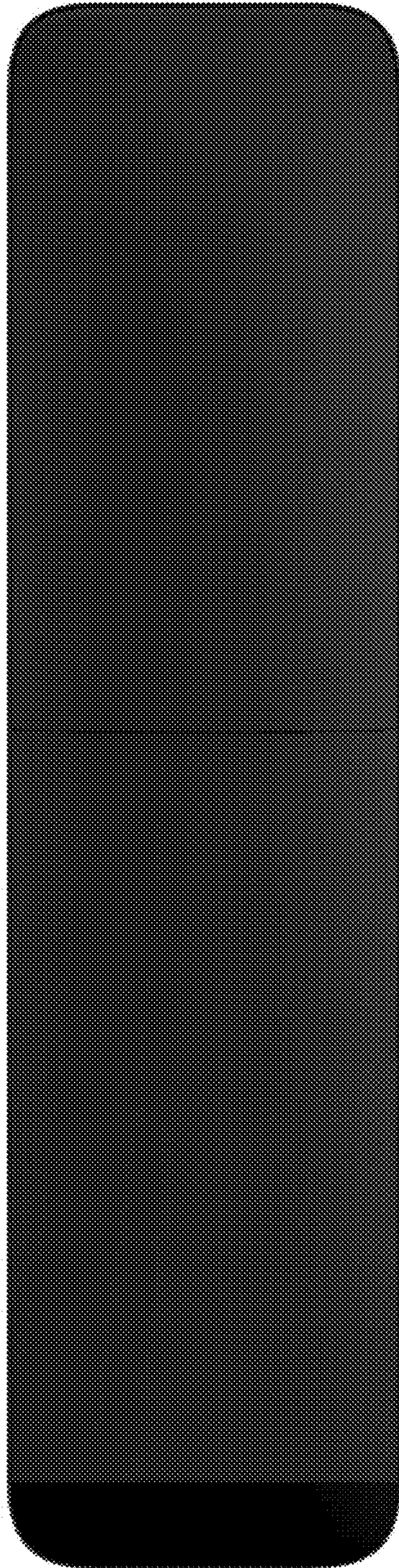

9.6

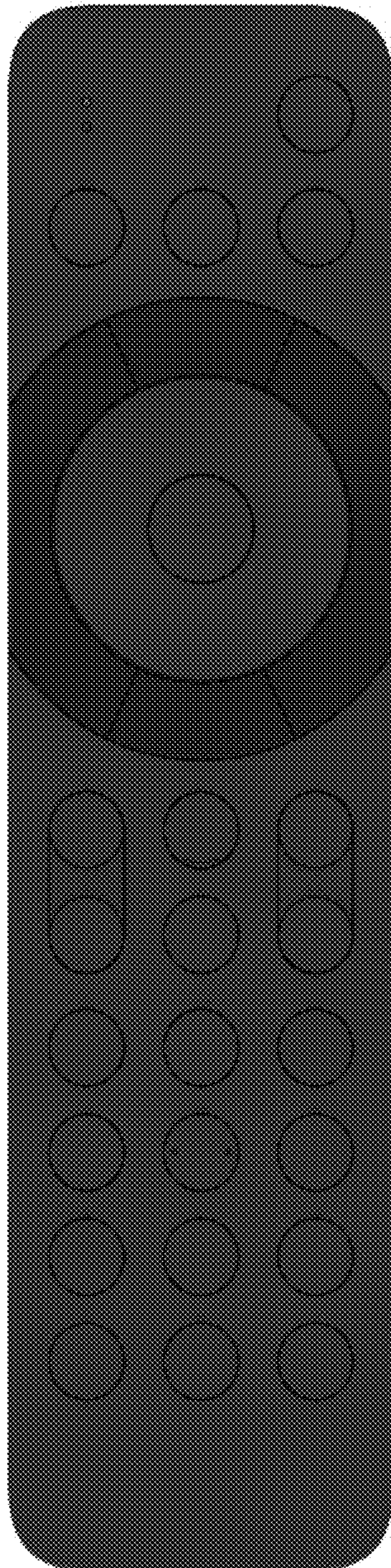

9.7

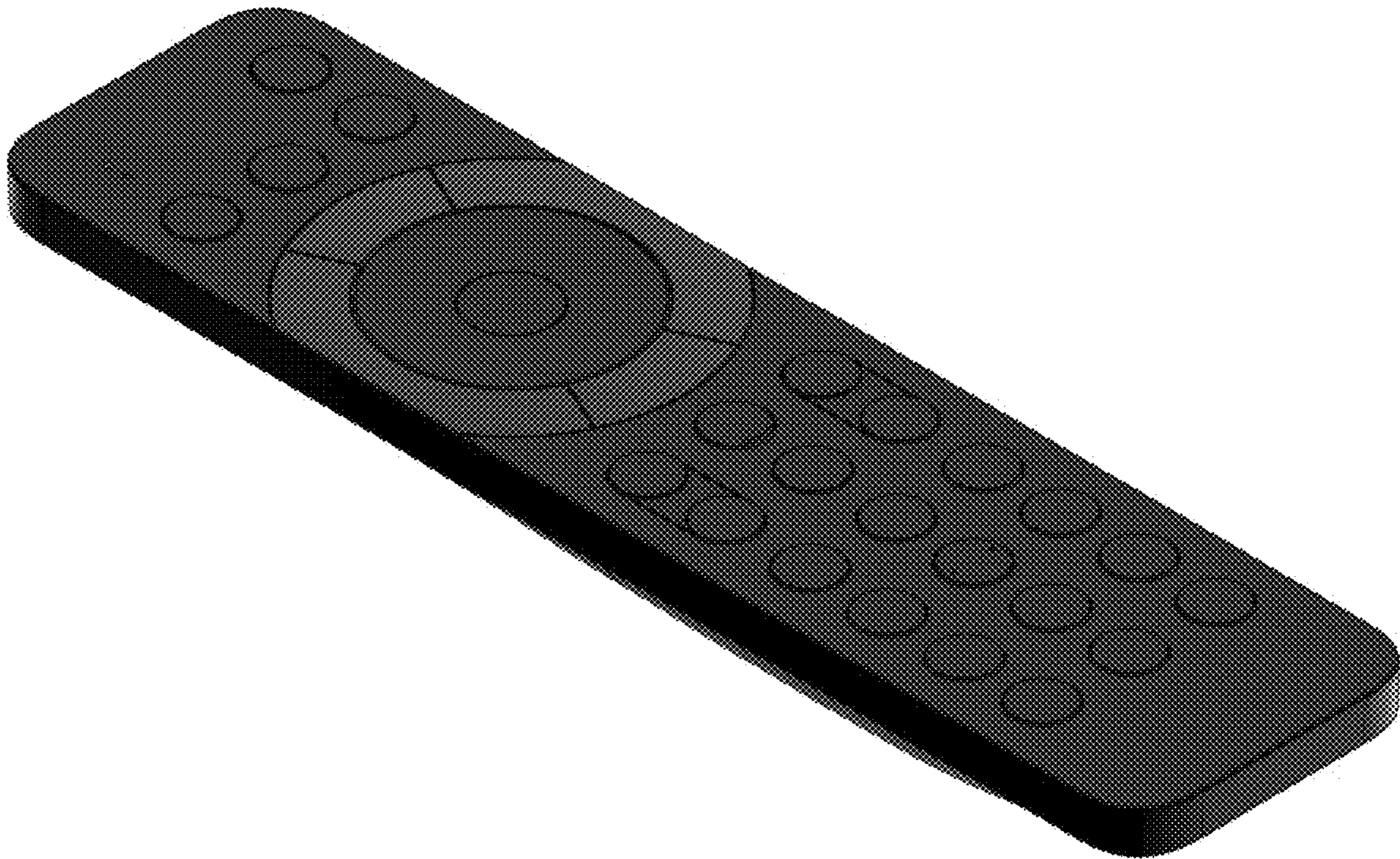

10.1

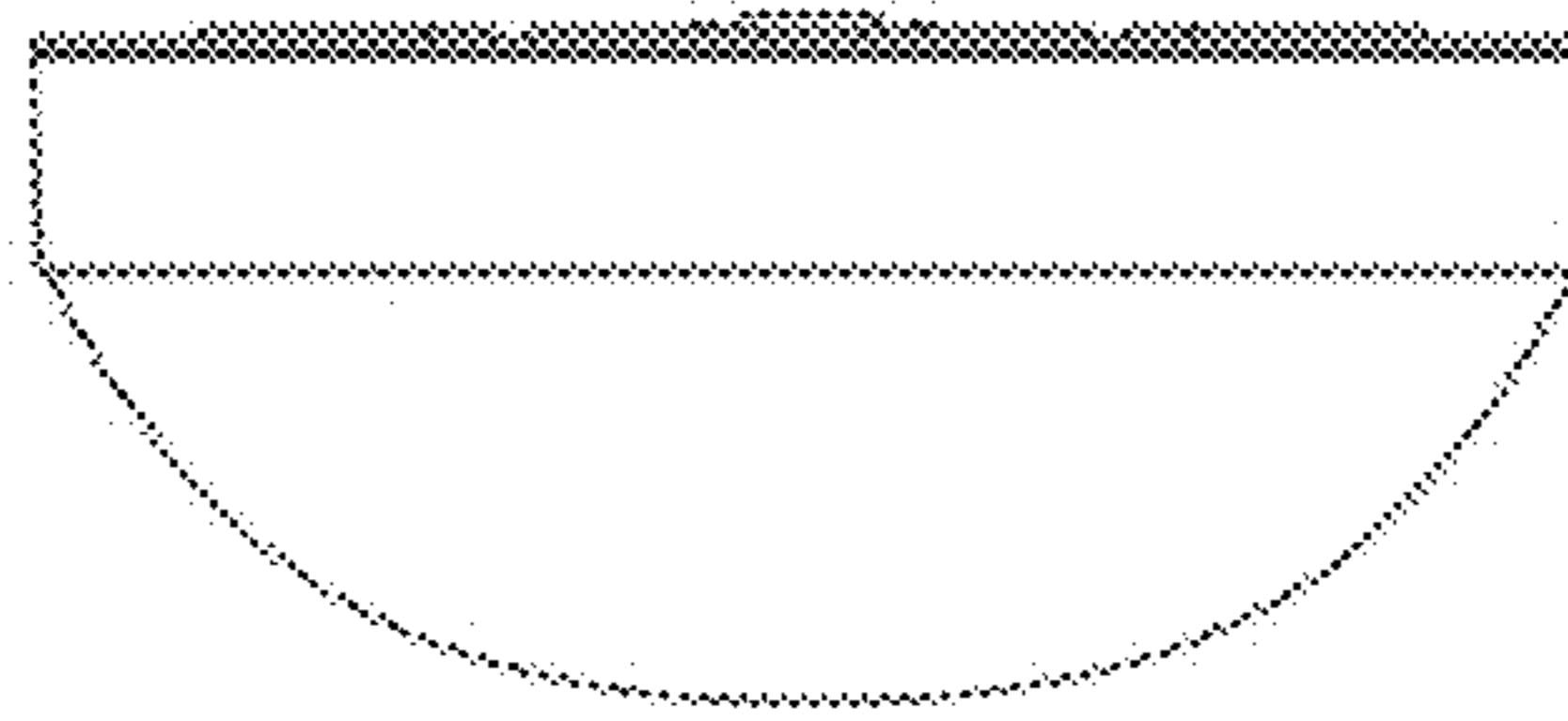

10.2

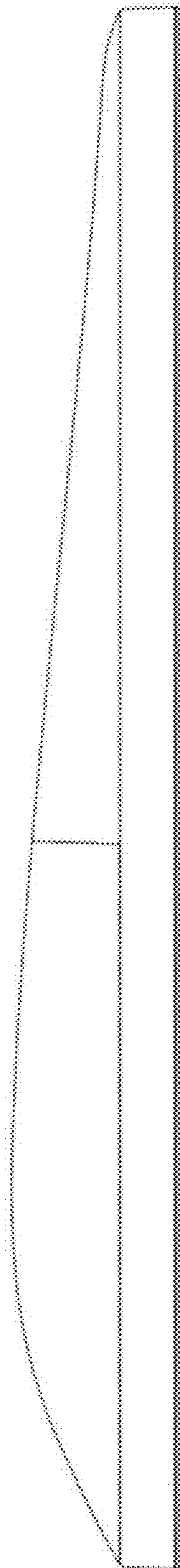

10.3

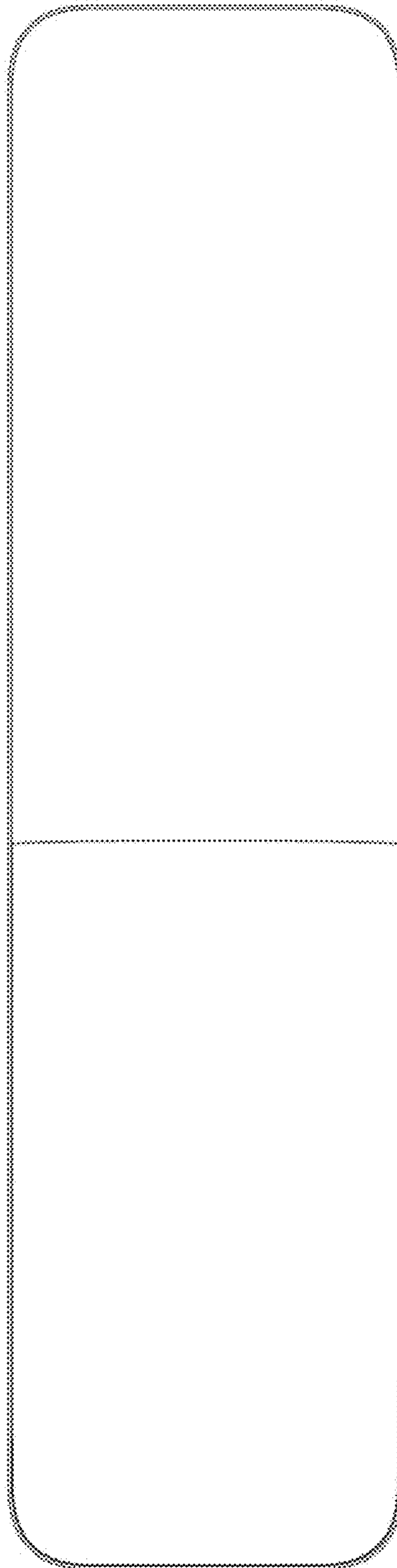

10.4

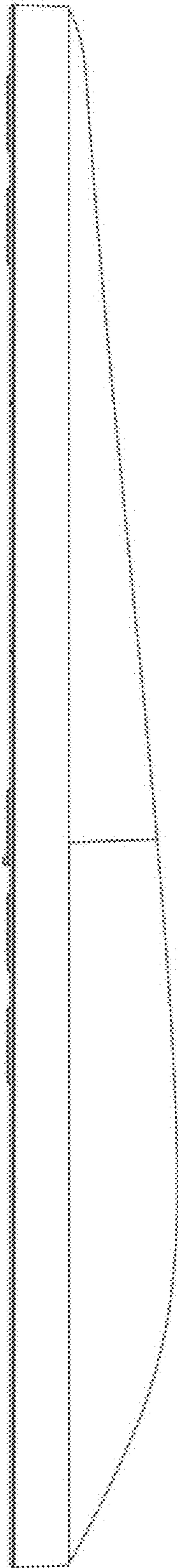

10.5

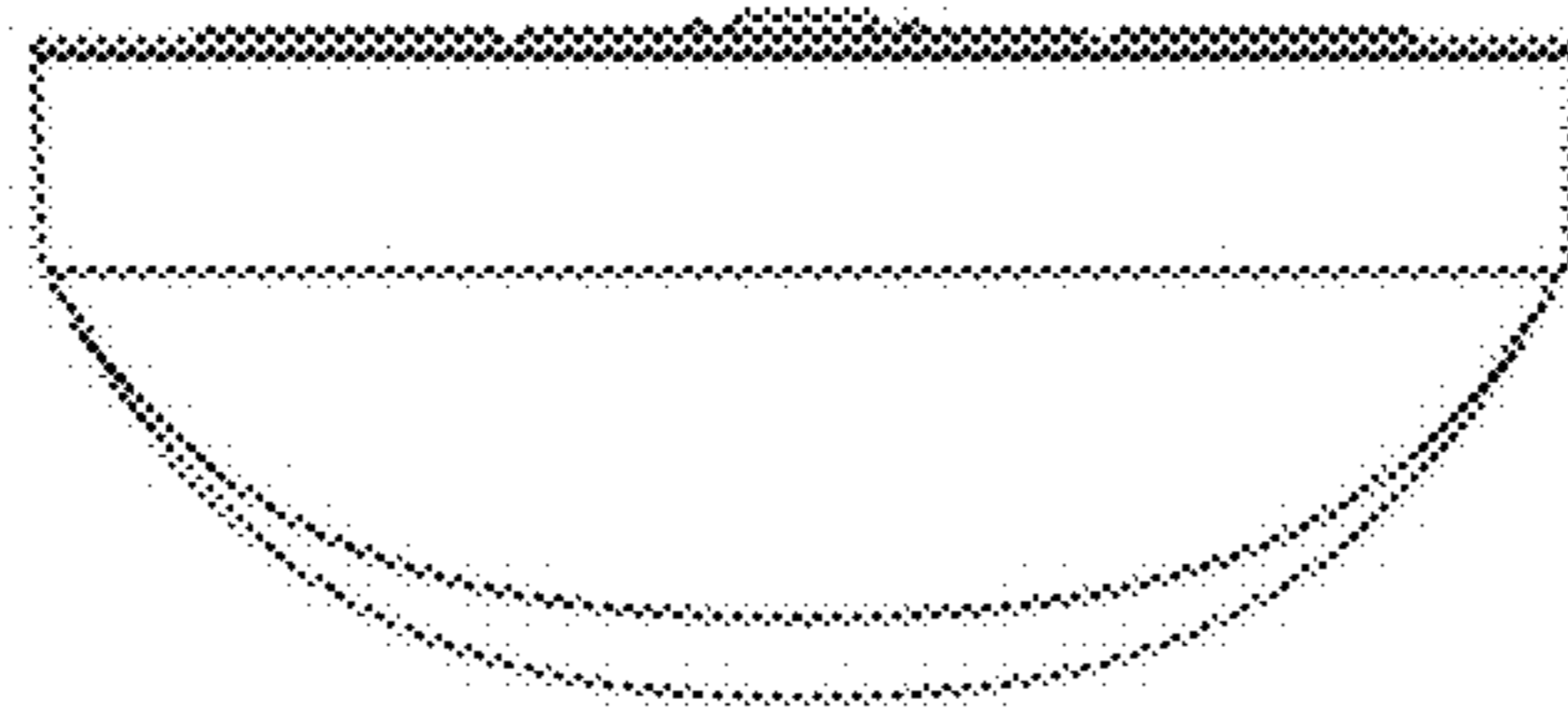

10.6

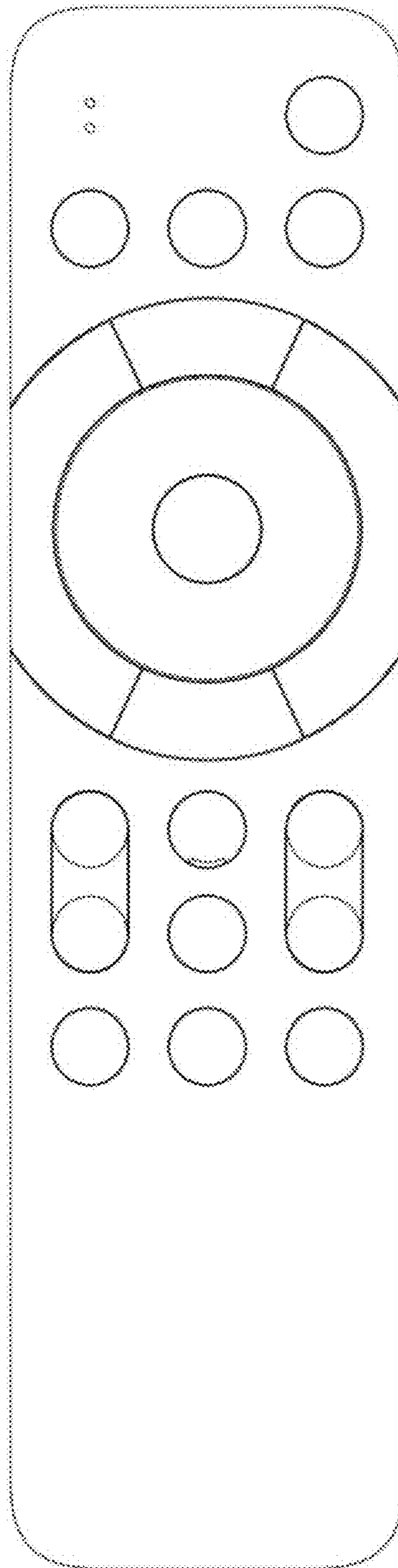

10.7

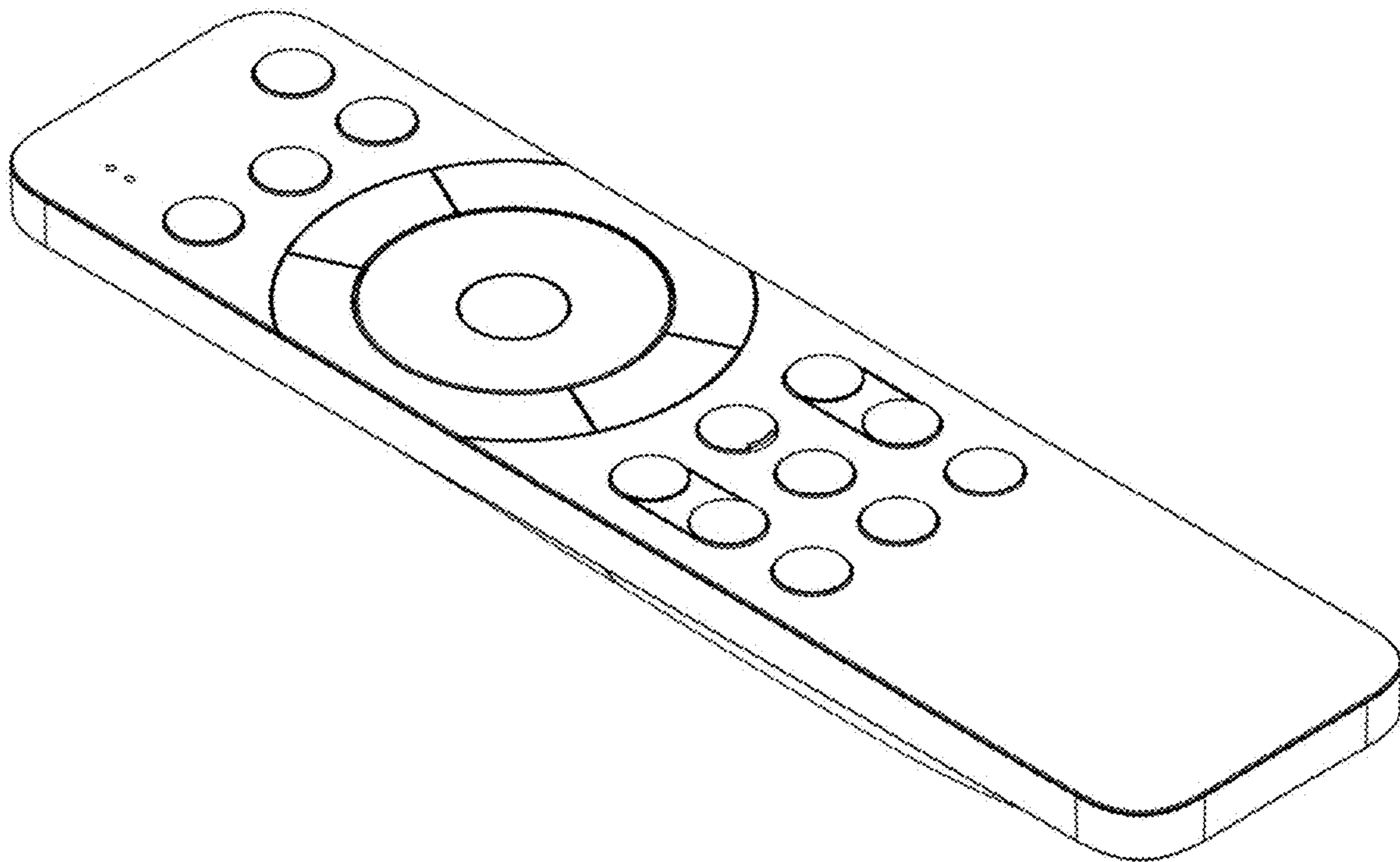

11.1

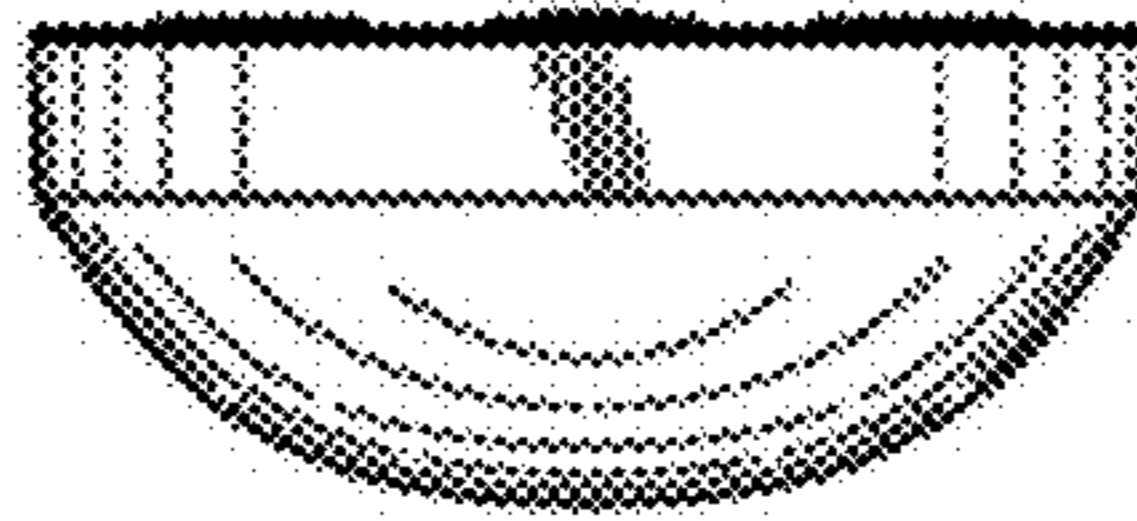

11.2

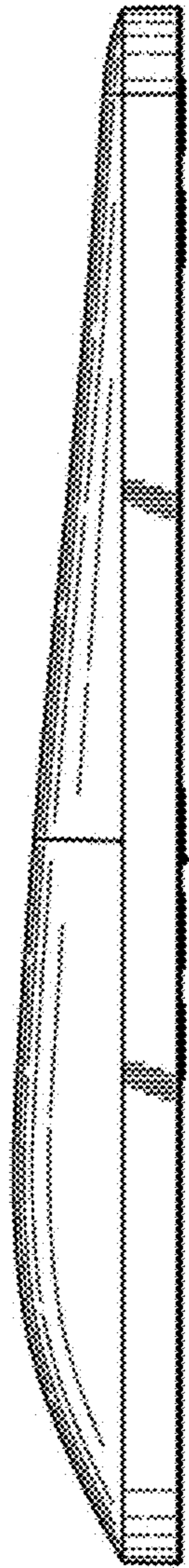

11.3

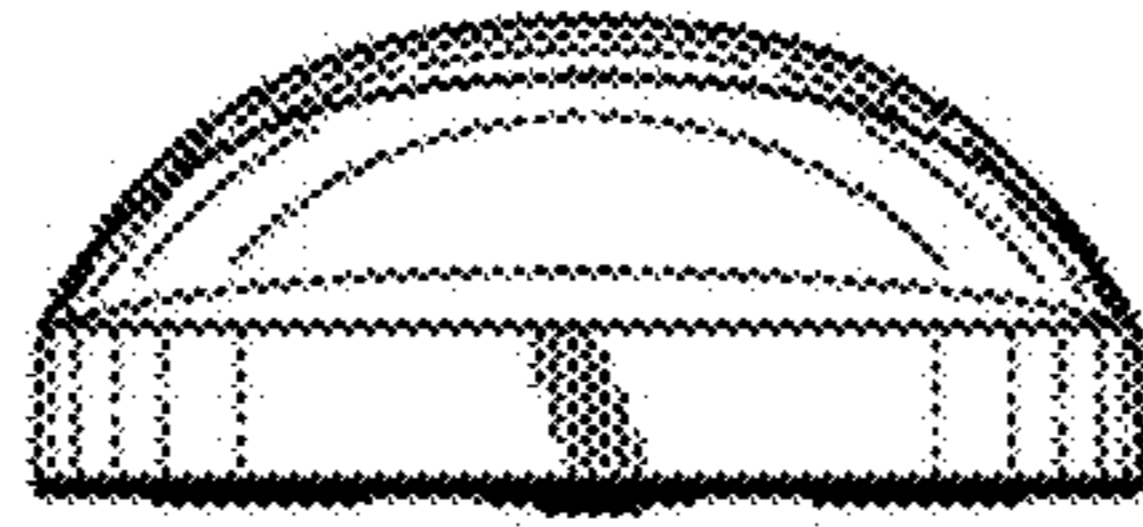

11.4

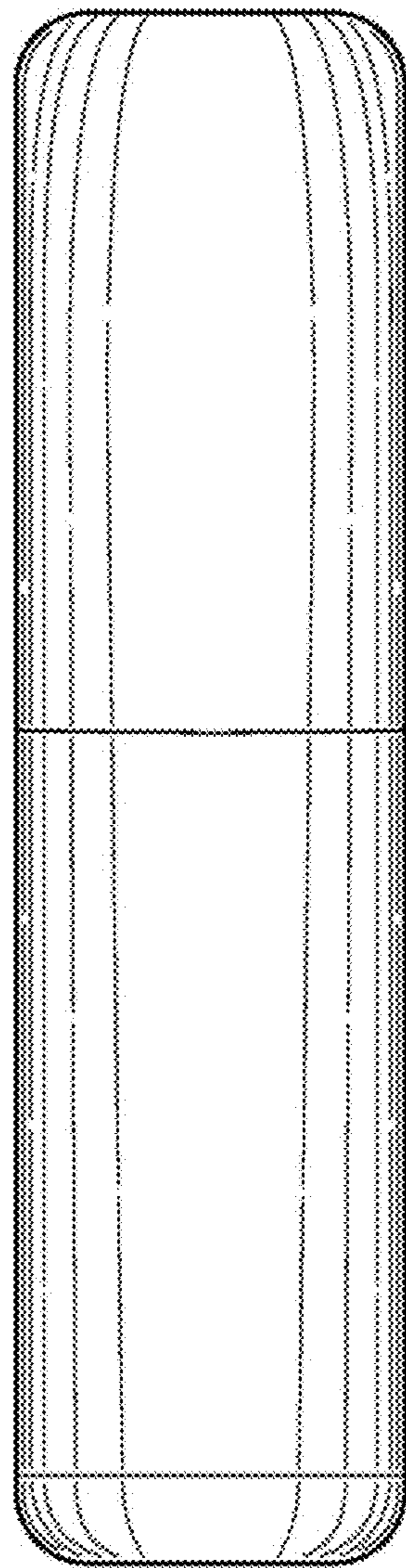

11.5

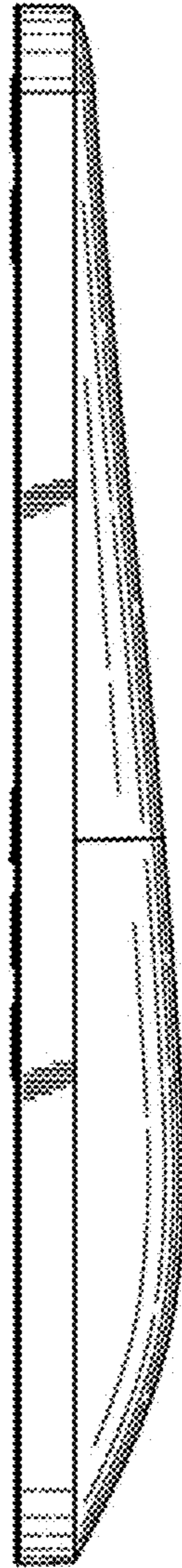

11.6

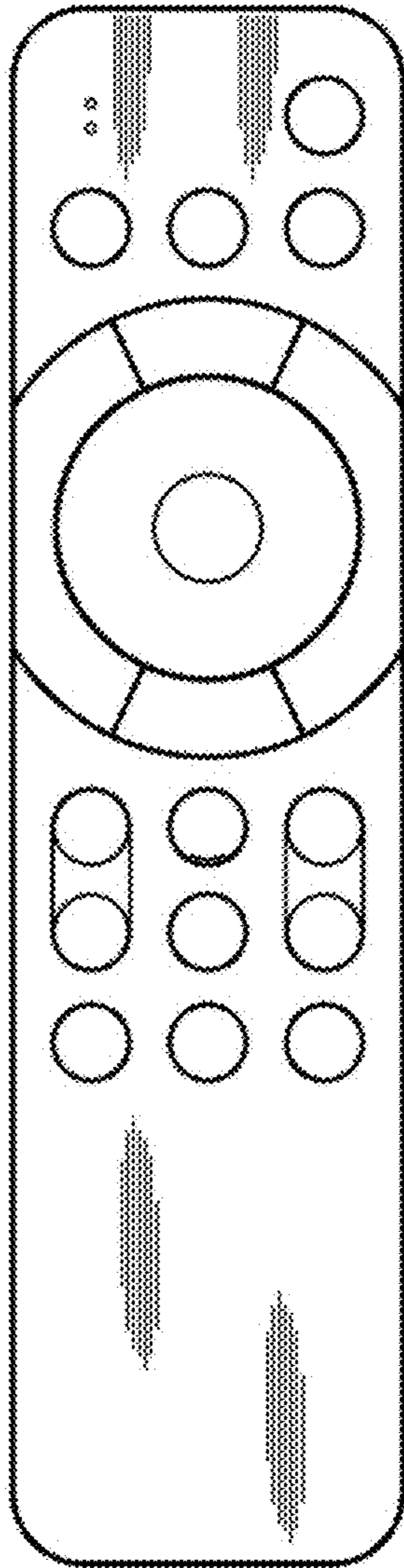

11.7

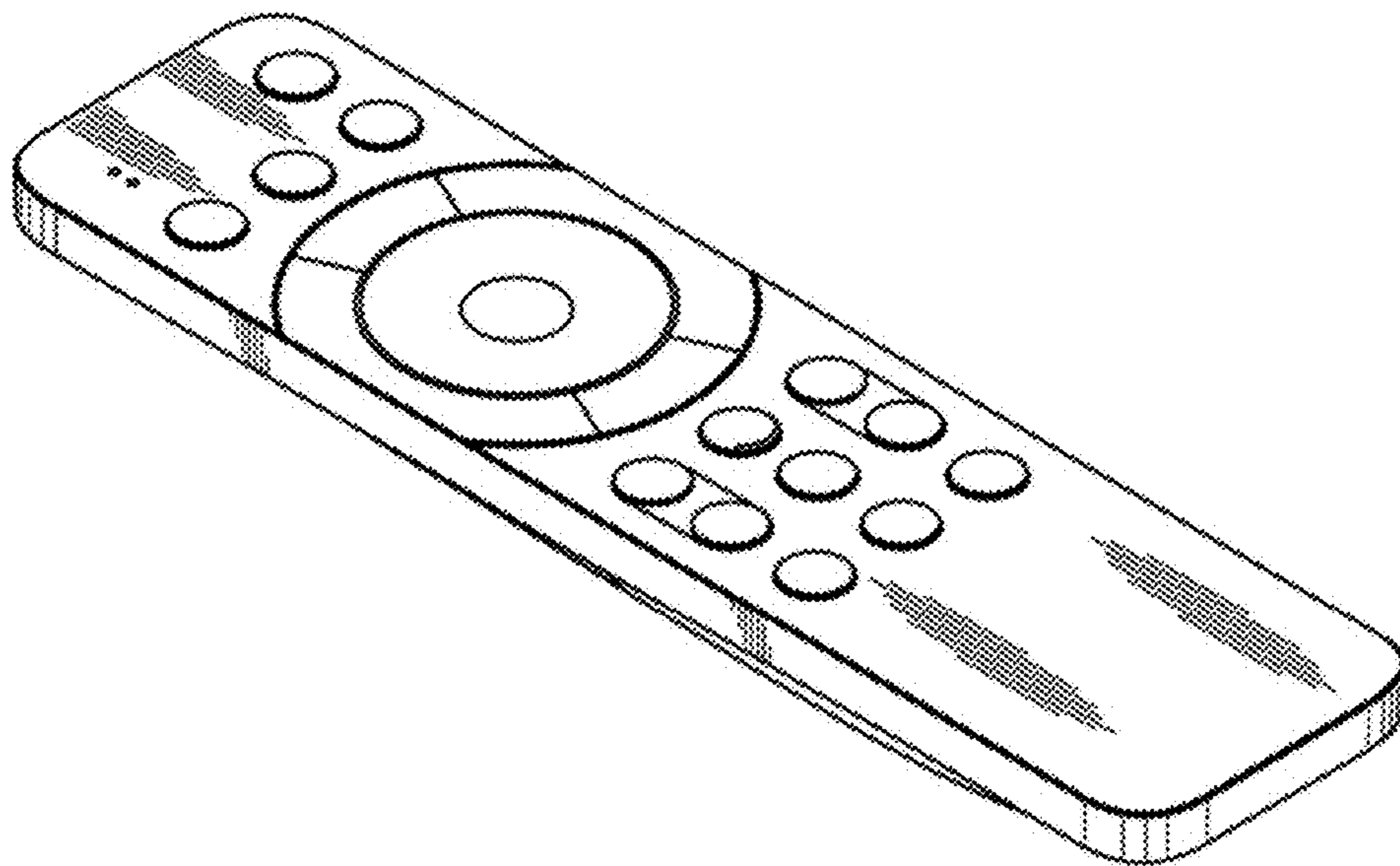

12.1

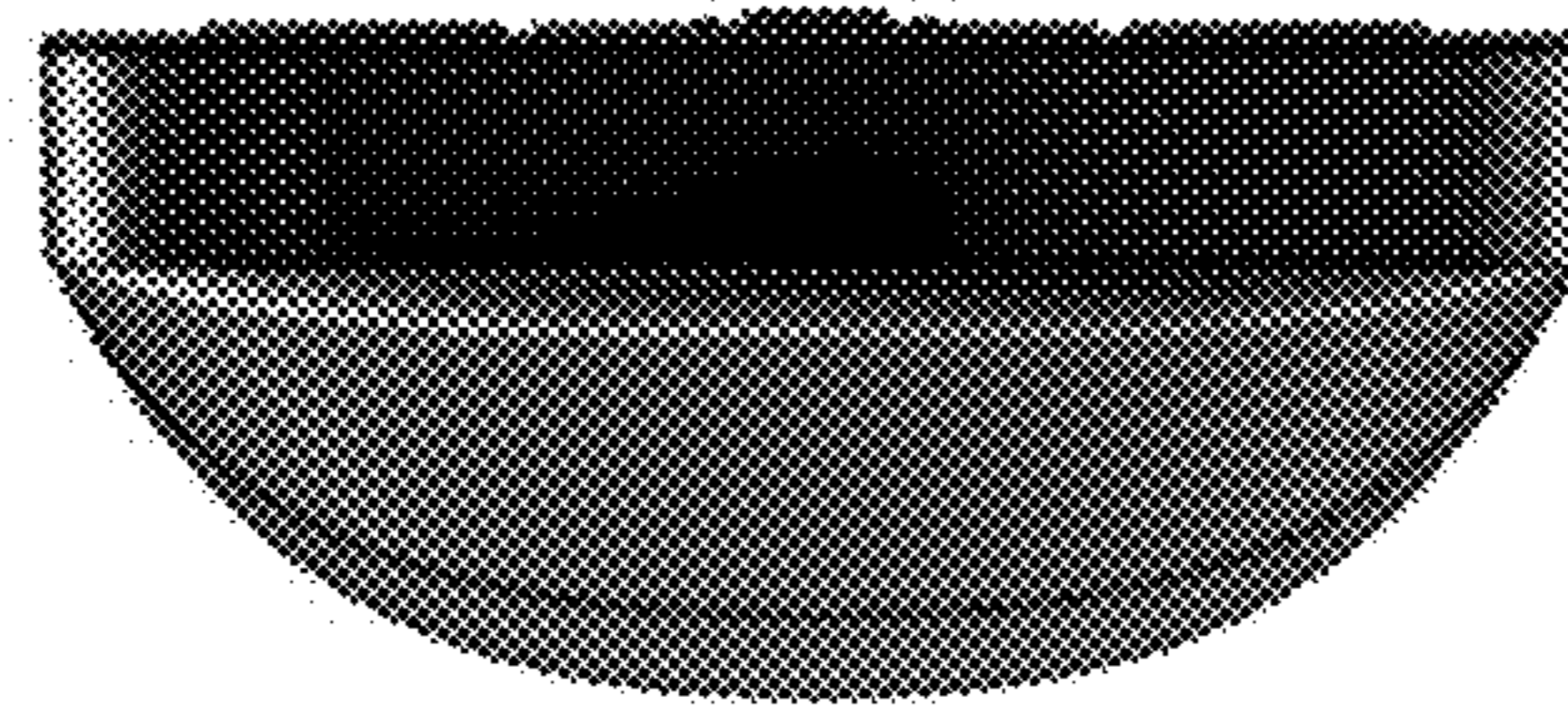

12.2

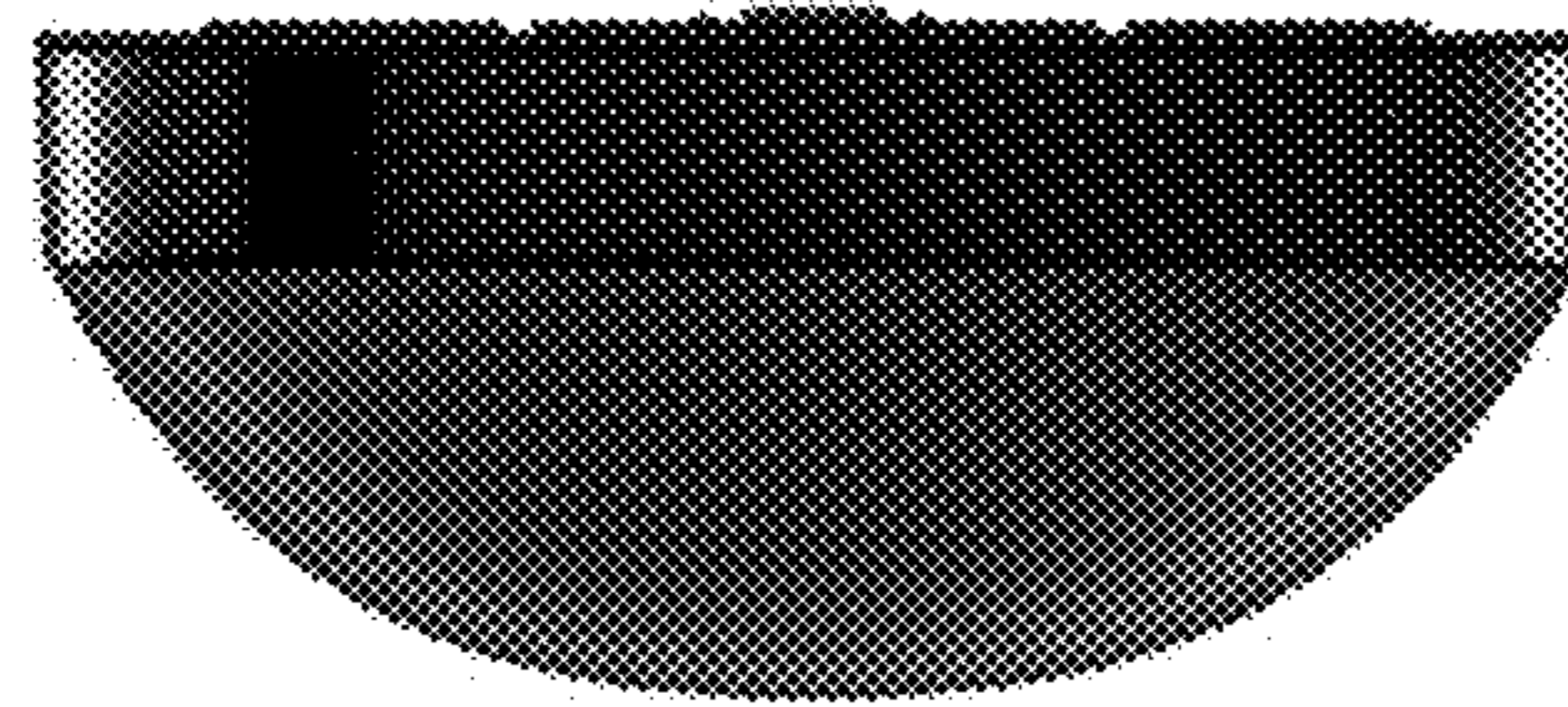

12.3

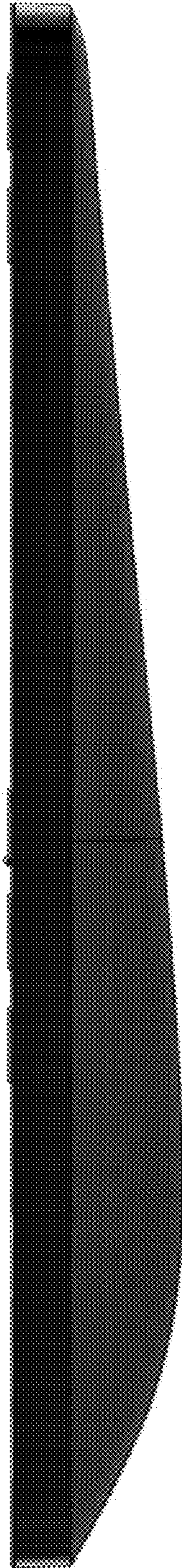

12.4

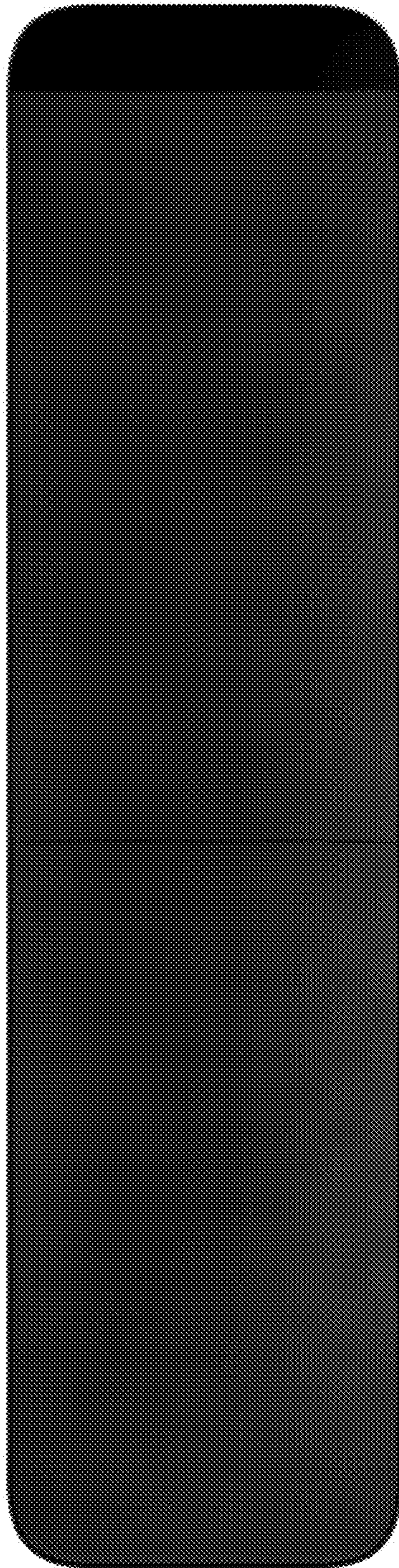

12.5

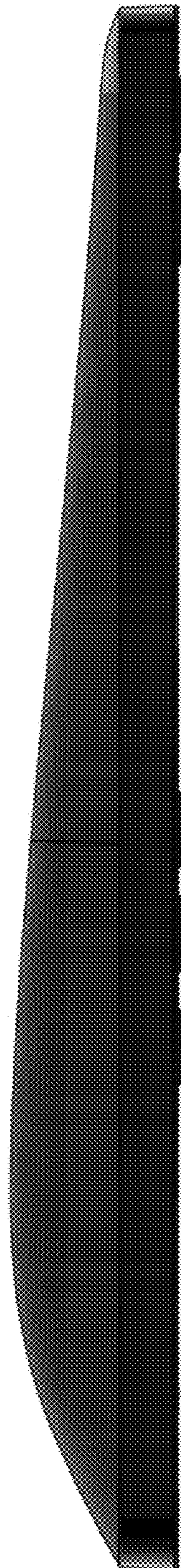

12.6

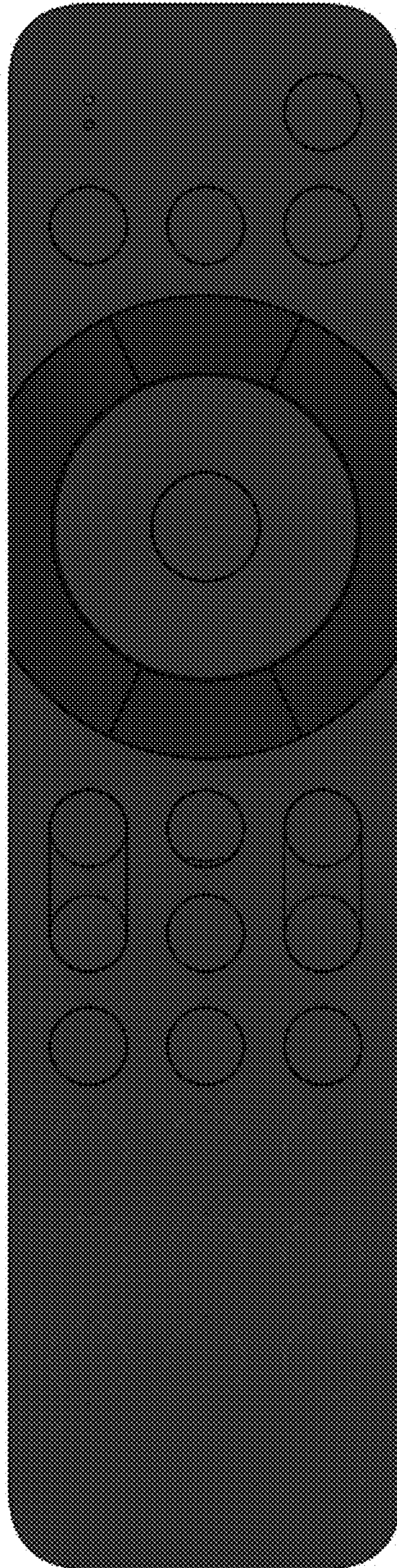

12.7

