



US00D834989S

(12) **United States Design Patent** (10) **Patent No.:** **US D834,989 S**  
**Pandolfino** (45) **Date of Patent:** **\*\* Dec. 4, 2018**

(54) **METAL NECKWEAR**

(57) **CLAIM**

(71) Applicant: **PATUGA LLC**, Clarence, NY (US)  
(72) Inventor: **Joseph Pandolfino**, Clarence, NY (US)  
(73) Assignee: **PATUGA LLC**, Clarence, NY (US)  
(\*\*) Term: **15 Years**

The ornamental design for metal neckwear, as shown and described.

(21) Appl. No.: **29/612,088**  
(22) Filed: **Jul. 28, 2017**  
(51) **LOC (11) Cl.** ..... **11-01**  
(52) **U.S. Cl.**  
USPC ..... **D11/79; D2/605; D11/1**  
(58) **Field of Classification Search**  
USPC ..... D11/1, 2, 3, 7, 8, 12, 19, 40–54, 79–86,  
D11/87, 91, 92, 93; D3/207; D6/300;  
D2/600–609, 627, 633, 637  
(Continued)

**DESCRIPTION**

FIG. 1 is a front elevation view of a first embodiment of metal neckwear showing my new design;  
FIG. 2 is a rear elevation view thereof;  
FIG. 3 is a right side elevation view thereof;  
FIG. 4 is a left side elevation view thereof;  
FIG. 5 is a top plan view thereof;  
FIG. 6 is a bottom plan view thereof;  
FIG. 7 is a front, right-sided perspective view thereof;  
FIG. 8 is a rear, left-sided perspective view thereof;  
FIG. 9 is a front elevation view of a second embodiment of metal neckwear showing my new design;  
FIG. 10 is a rear elevation view thereof;  
FIG. 11 is a right side elevation view thereof;  
FIG. 12 is a left side elevation view thereof;  
FIG. 13 is a top plan view thereof;  
FIG. 14 is a bottom plan view thereof;  
FIG. 15 is a front, right-sided perspective view thereof;  
FIG. 16 is a rear, left-sided perspective view thereof;  
FIG. 17 is a front elevation view of a third embodiment of metal neckwear showing my new design;  
FIG. 18 is a rear elevation view thereof;  
FIG. 19 is a right side elevation view thereof;  
FIG. 20 is a left side elevation view thereof;  
FIG. 21 is a top plan view thereof;  
FIG. 22 is a bottom plan view thereof;  
FIG. 23 is a front, right-sided perspective view thereof;  
FIG. 24 is a rear, left-sided perspective view thereof;  
FIG. 25 is a front elevation view of a fourth embodiment of metal neckwear showing my new design;  
FIG. 26 is a rear elevation view thereof;  
FIG. 27 is a right side elevation view thereof;  
FIG. 28 is a left side view elevation thereof;  
FIG. 29 is a top plan view thereof;  
FIG. 30 is a bottom plan view thereof;  
FIG. 31 is a front, right-sided perspective view thereof;

(56) **References Cited**

**U.S. PATENT DOCUMENTS**

D4,543 S \* 12/1870 Waldron et al. .... D8/499  
1,065,006 A \* 6/1913 Sommer ..... A44C 11/00  
59/80

(Continued)

**FOREIGN PATENT DOCUMENTS**

AT 389630 B 1/1990  
CN 2888922 Y 4/2007  
WO 88/06414 A1 9/1988

**OTHER PUBLICATIONS**

[Online] <http://themetapicture.com/they-look-like-the-ties-of-the-future/>. Posted online Jun. 14, 2015. Retrieved Jul. 6, 2018.\*

(Continued)

*Primary Examiner* — Melanie Pellegrini  
(74) *Attorney, Agent, or Firm* — Sughrue Mion, PLLC

(Continued)

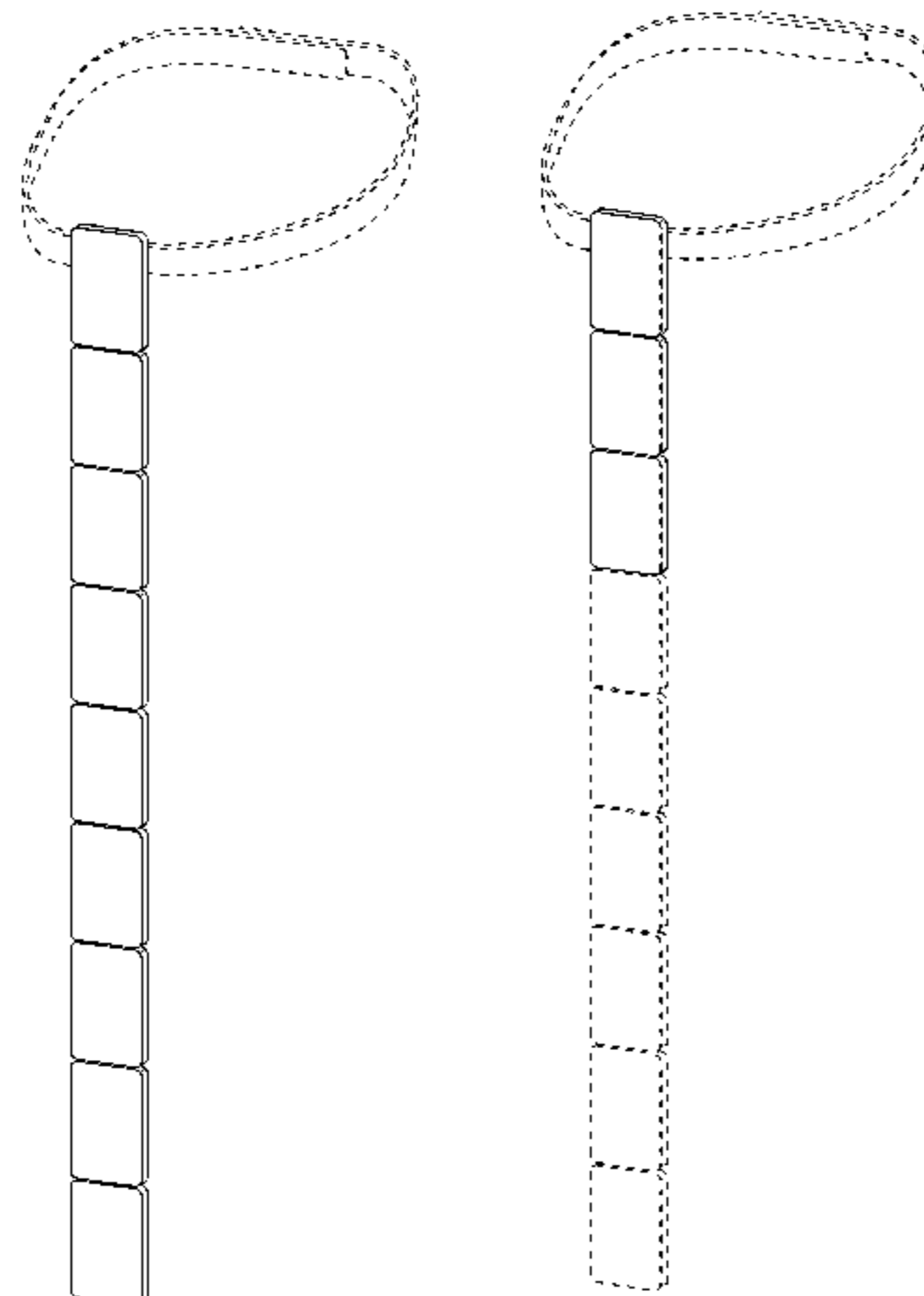


FIG. 32 is a rear, left-sided perspective view thereof;  
 FIG. 33 is a front elevation view of a fifth embodiment of metal neckwear showing my new design;  
 FIG. 34 is a rear elevation view thereof;  
 FIG. 35 is a right side elevation view thereof;  
 FIG. 36 is a left side elevation view thereof;  
 FIG. 37 is a top plan view thereof;  
 FIG. 38 is a bottom plan view thereof;  
 FIG. 39 is a front, right-sided perspective view thereof;  
 FIG. 40 is a rear, left-sided perspective view thereof;  
 FIG. 41 is a front elevation view of a sixth embodiment of metal neckwear showing my new design;  
 FIG. 42 is a rear elevation view thereof;  
 FIG. 43 is a right side elevation view thereof;  
 FIG. 44 is a left side elevation view thereof;  
 FIG. 45 is a top plan view thereof;  
 FIG. 46 is a bottom plan view thereof;  
 FIG. 47 is a front, right-sided perspective view thereof;  
 FIG. 48 is a rear, left-sided perspective view thereof;  
 FIG. 49 is a front elevation view of a seventh embodiment of metal neckwear showing my new design;  
 FIG. 50 is a rear elevation view thereof;  
 FIG. 51 is a right side elevation view thereof;  
 FIG. 52 is a left side elevation view thereof;  
 FIG. 53 is a top plan view thereof;  
 FIG. 54 is a bottom plan view thereof;  
 FIG. 55 is a front, right-sided perspective view thereof;  
 FIG. 56 is a rear, left-sided perspective view thereof;  
 FIG. 57 is a front elevation view of an eighth embodiment of metal neckwear showing my new design;  
 FIG. 58 is a rear elevation view thereof;  
 FIG. 59 is a right side elevation view thereof;  
 FIG. 60 is a left side elevation view thereof;  
 FIG. 61 is a top plan view thereof;  
 FIG. 62 is a bottom plan view thereof;  
 FIG. 63 is a front, right-sided perspective view thereof; and,  
 FIG. 64 is a rear, left-sided perspective view thereof.  
 The broken lines showing a circular neck strap represent environment and form no part of the claimed design. All other broken lines represent portions of the metal neckwear which form no part of the claimed design.

**1 Claim, 32 Drawing Sheets**

(58) **Field of Classification Search**

CPC .. A44C 1/00; A44C 3/00; A44C 3/004; A44C 3/005; A44C 3/007; A44C 3/008; A44C 5/02; A44C 7/002; A44C 25/00; A44C 25/001; A44C 25/002; A44C 25/004; A44C 25/005; A44C 25/007; A41D 23/00; A41D 25/00; A41D 25/003; A41D 25/004; A41D 25/005; A41D 25/008; A41D 25/02; A41D 25/06

See application file for complete search history.

(56)

**References Cited**

U.S. PATENT DOCUMENTS

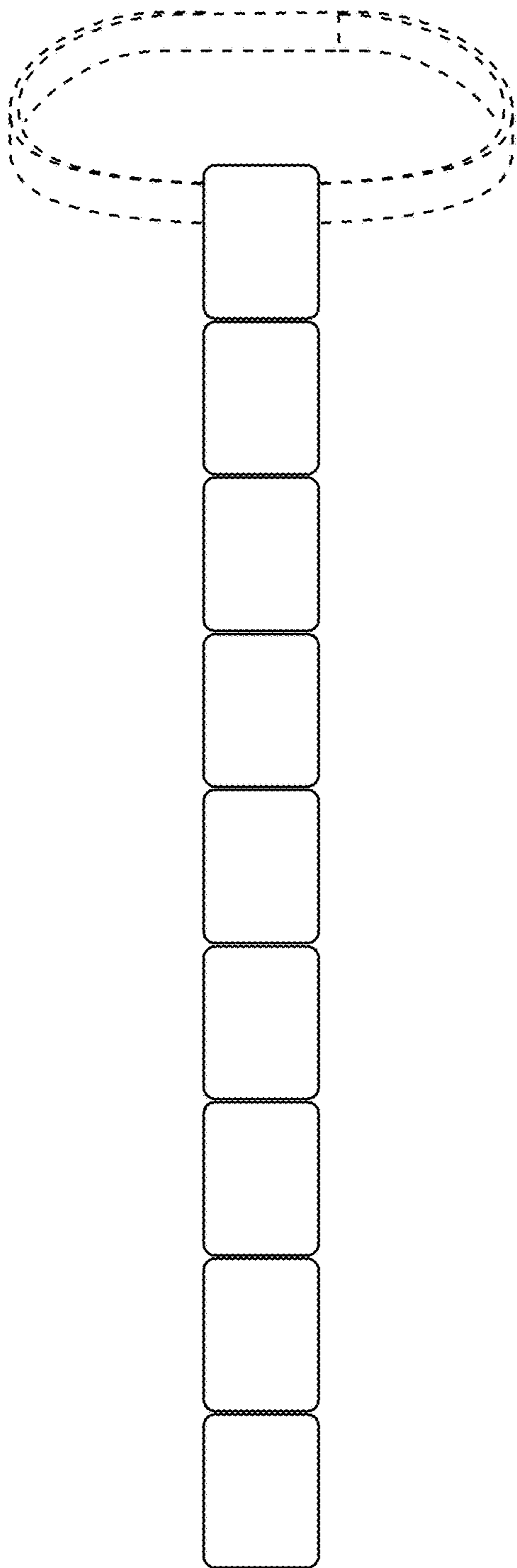
1,626,139	A *	4/1927	Kraysler .....	A44C 5/02
				16/229
D78,958	S *	7/1929	Wewetzer .....	D10/32
D105,807	S *	8/1937	Raymond .....	D11/121
2,090,789	A *	8/1937	Forstner .....	A41F 9/002
				2/300
D112,303	S	11/1938	Huddle	
2,176,253	A *	10/1939	Fogarty .....	A45C 13/42
				40/661.06
D156,650	S *	12/1949	Pearce et al. ....	D11/12
D161,798	S *	1/1951	Spielman .....	D2/605
D178,725	S *	9/1956	Flynn .....	D2/637
D203,059	S *	11/1965	Maroun .....	D11/7
D230,540	S	3/1974	Gillman	
D249,339	S *	9/1978	Coulthurst .....	D11/79
4,546,494	A	10/1985	Garber	
D285,143	S *	8/1986	Kirk .....	D11/208
4,627,113	A	12/1986	Lord	
D301,520	S *	6/1989	Campbell .....	D2/608
5,016,285	A *	5/1991	Just .....	A41D 25/00
				2/144
D318,754	S	8/1991	Hughes	
5,036,550	A	8/1991	Wilsey	
D320,499	S	10/1991	White et al.	
D322,227	S *	12/1991	Warhol .....	D10/32
5,238,528	A *	8/1993	Heinrich .....	A41D 25/00
				216/36
D340,871	S *	11/1993	Iwamura .....	D10/125
D374,111	S	10/1996	Wilson	
D382,504	S *	8/1997	Strasser .....	D11/12
5,673,434	A	10/1997	Risk	
D398,435	S	9/1998	Gray	
D416,826	S *	11/1999	Newsome .....	D11/121
D450,398	S *	11/2001	Chang .....	D11/119
D457,287	S *	5/2002	Geisen .....	D2/608
D605,376	S *	12/2009	Dickerson .....	D2/605
D663,916	S	7/2012	Bracey	
D681,496	S *	5/2013	Goerges .....	D11/26
D714,178	S *	9/2014	Sabbioni .....	D11/3
9,161,582	B2	10/2015	Anderson	
D742,874	S *	11/2015	Cheng .....	D14/344
D748,370	S	2/2016	Johnson	
D775,777	S	1/2017	Peral	
D814,741	S *	4/2018	Peral .....	D2/605
D817,592	S *	5/2018	Pandolfino .....	D2/605

OTHER PUBLICATIONS

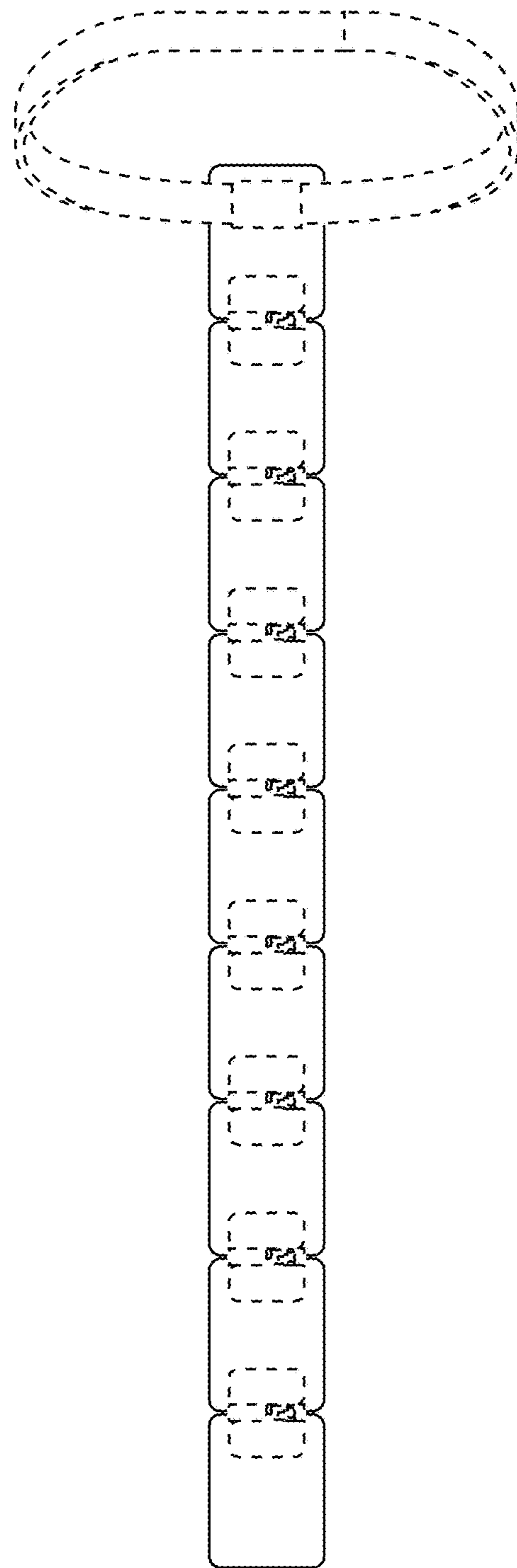
[Online] <http://www.blogyourwaytoantarctica.com/upload/2017/12/06/laureluxe-menswear-metal-tie-and-chain-suspenders-metal-tie-I-01453a4e7bc2e5f8.jpg>. Posted online Dec. 6, 2017. Retrieved Jul. 6, 2018.\*  
 Engineering Corner, <https://www.shapeways.com/product/MUT37CQWA/articulated-necktieclips-on-to-your-top-button>, 2 pages, author and publication date unknown, retrieved by Jul. 28, 2017.  
 The fusionguy, <https://thefusionguy.wordpress.com/category/woodworking/>, 2 pages, author and publication date unknown, retrieved by Jul. 28, 2017.  
<http://woodknot.com/>, 2 pages, author and publication date unknown, retrieved by Jul. 28, 2017.  
<http://www.jebiga.com/cams-wooden-ties-new-take-fashion/>, 2 pages, author and publication date unknown, retrieved by Jul. 28, 2017.  
<https://www.vat19.com/item/wood-tie>, 2 pages, author and publication date unknown, retrieved by Jul. 28, 2017.

\* cited by examiner

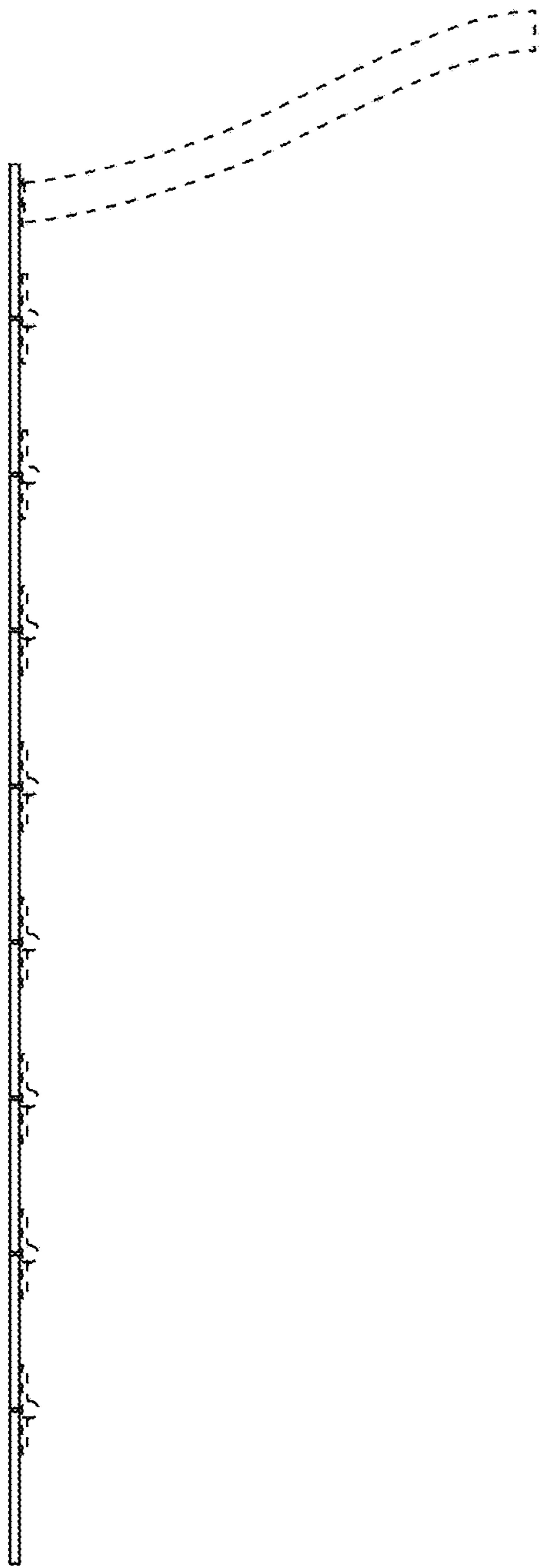




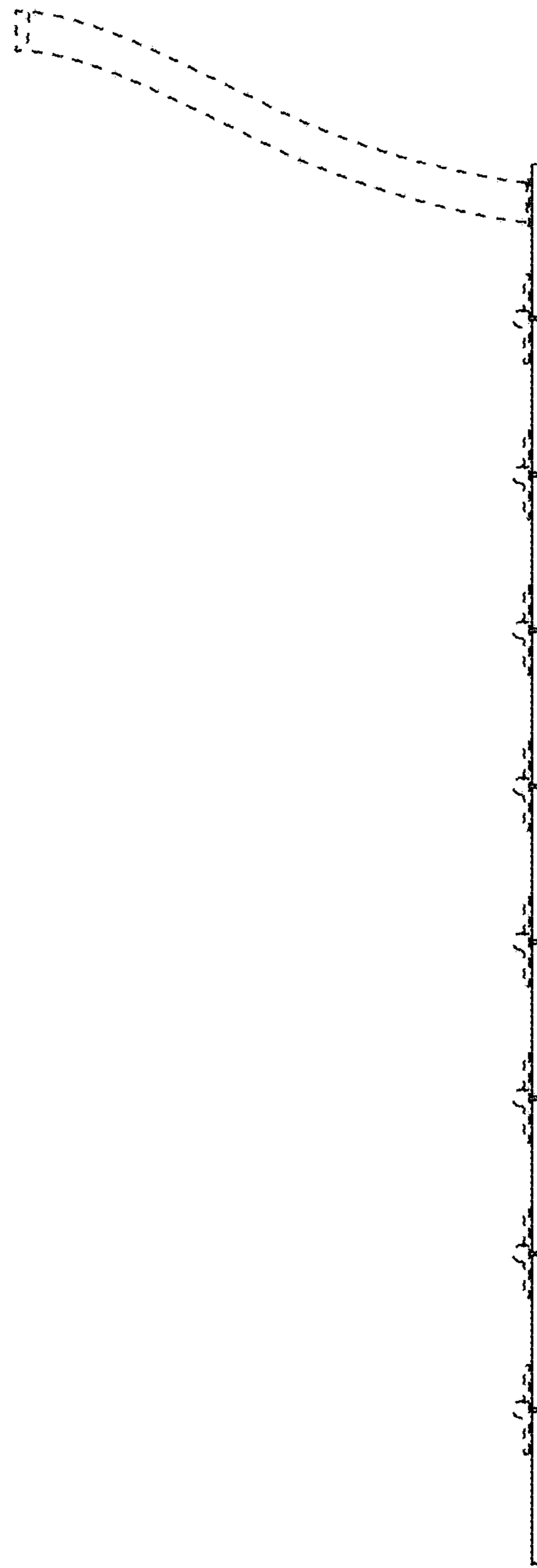
**FIG. 1**



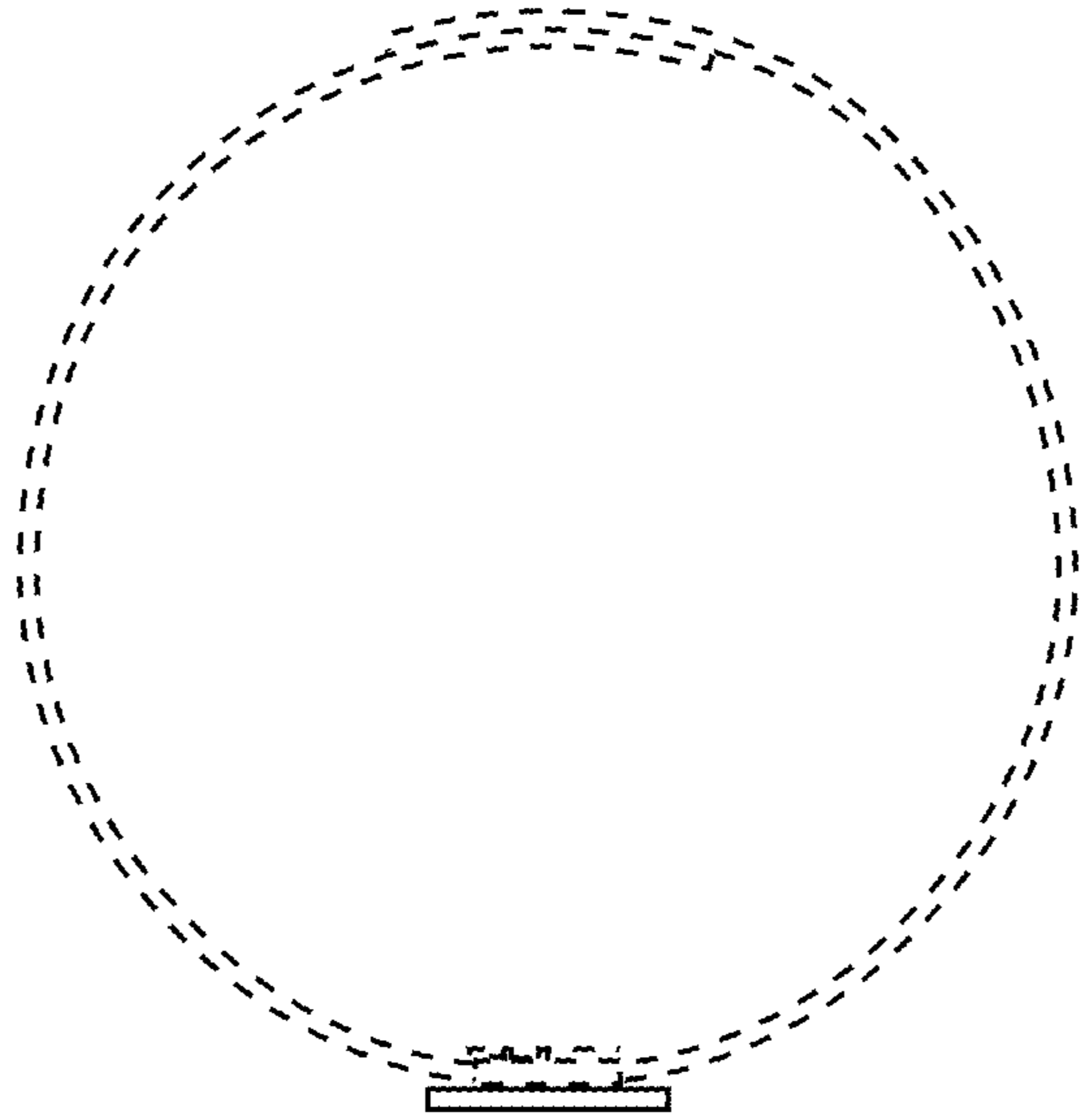
**FIG. 2**



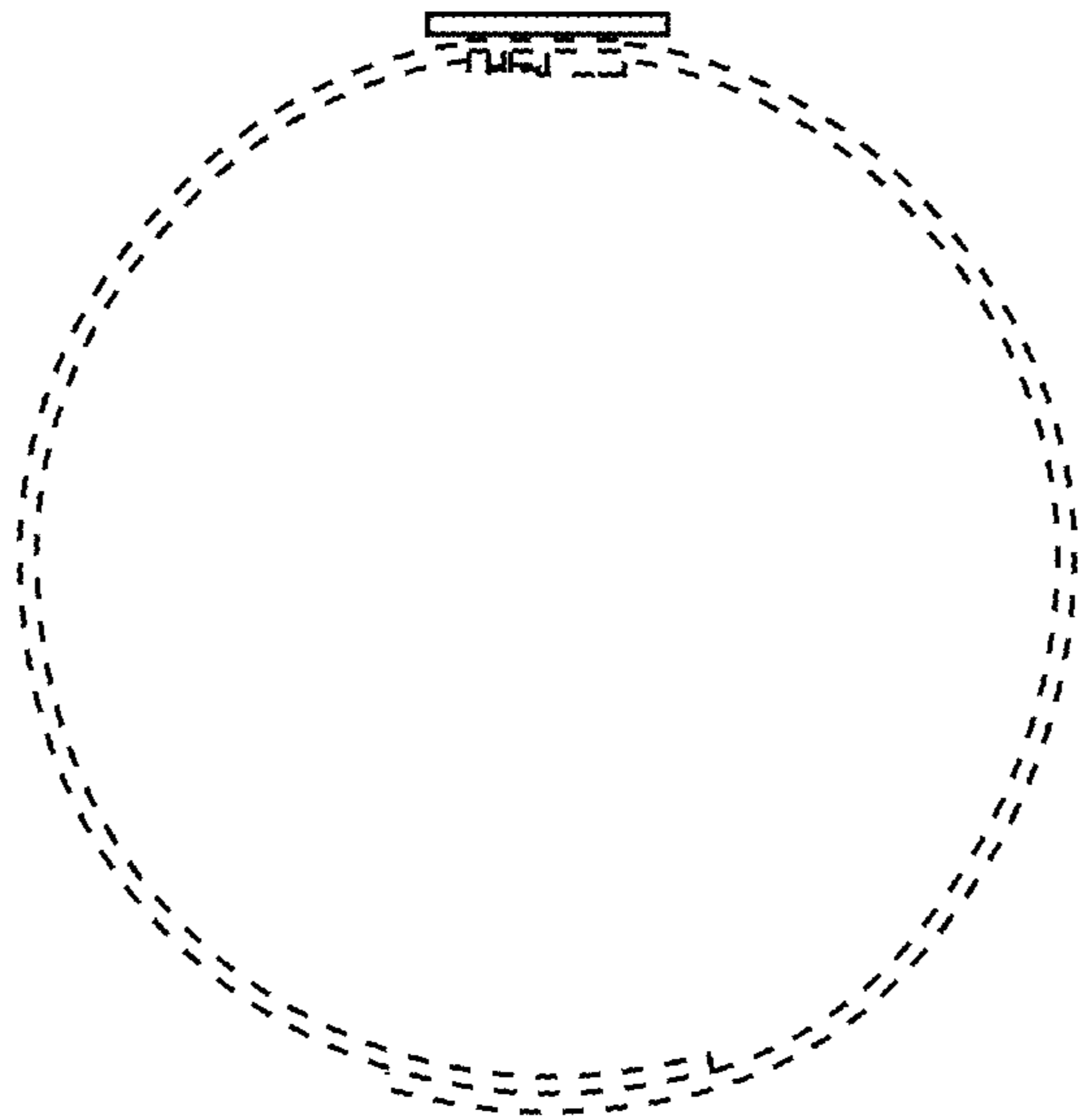
**FIG. 3**



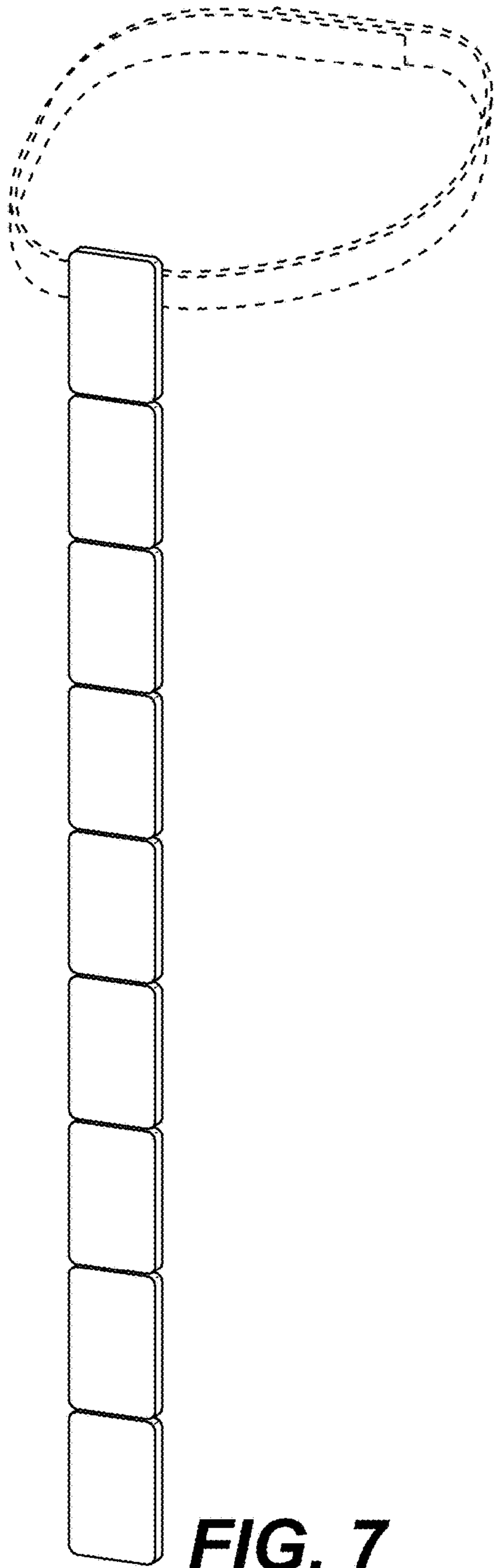
**FIG. 4**



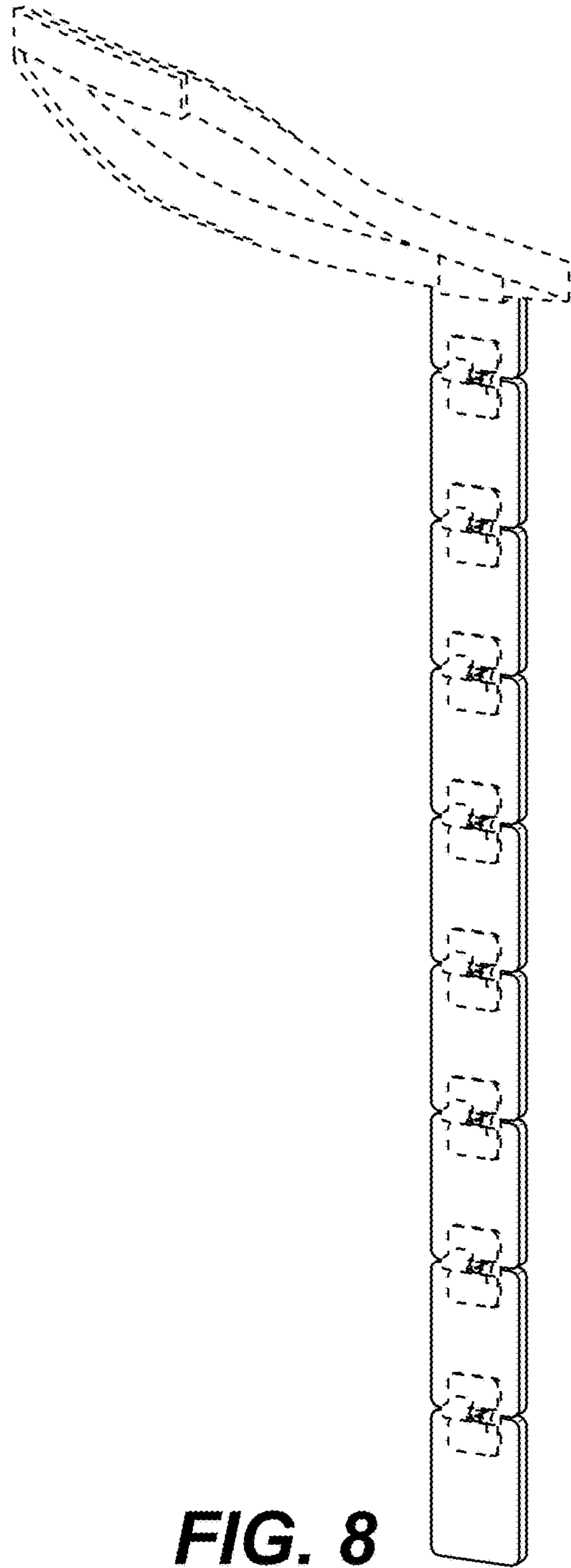
**FIG. 5**



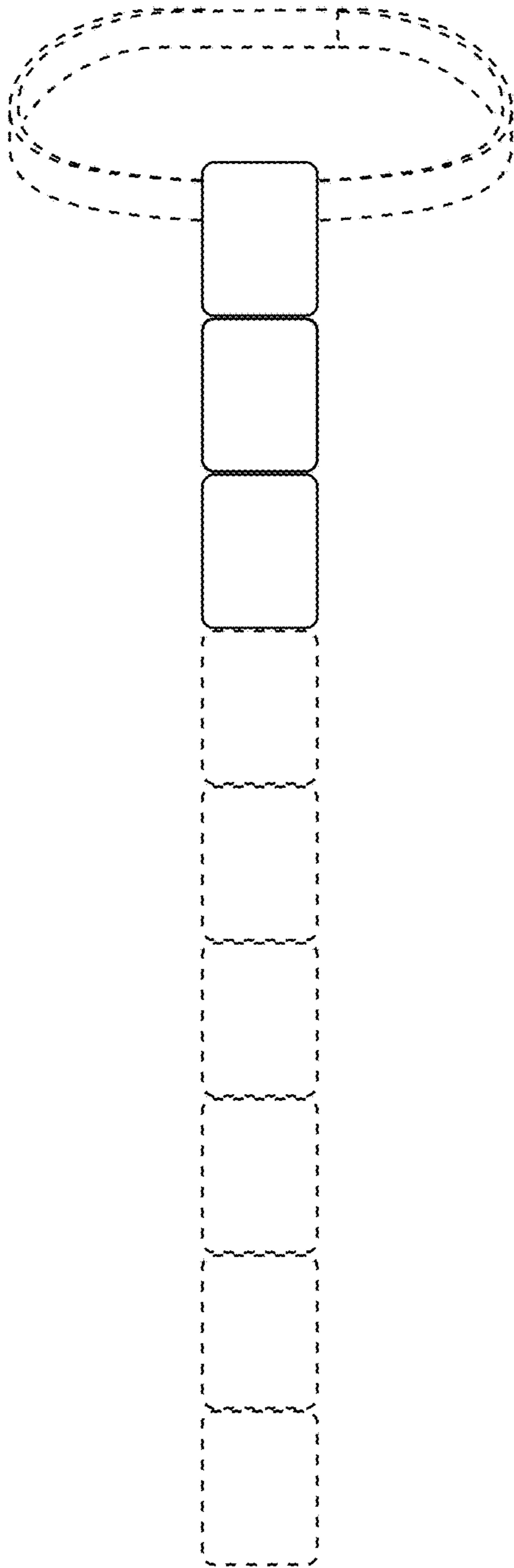
**FIG. 6**



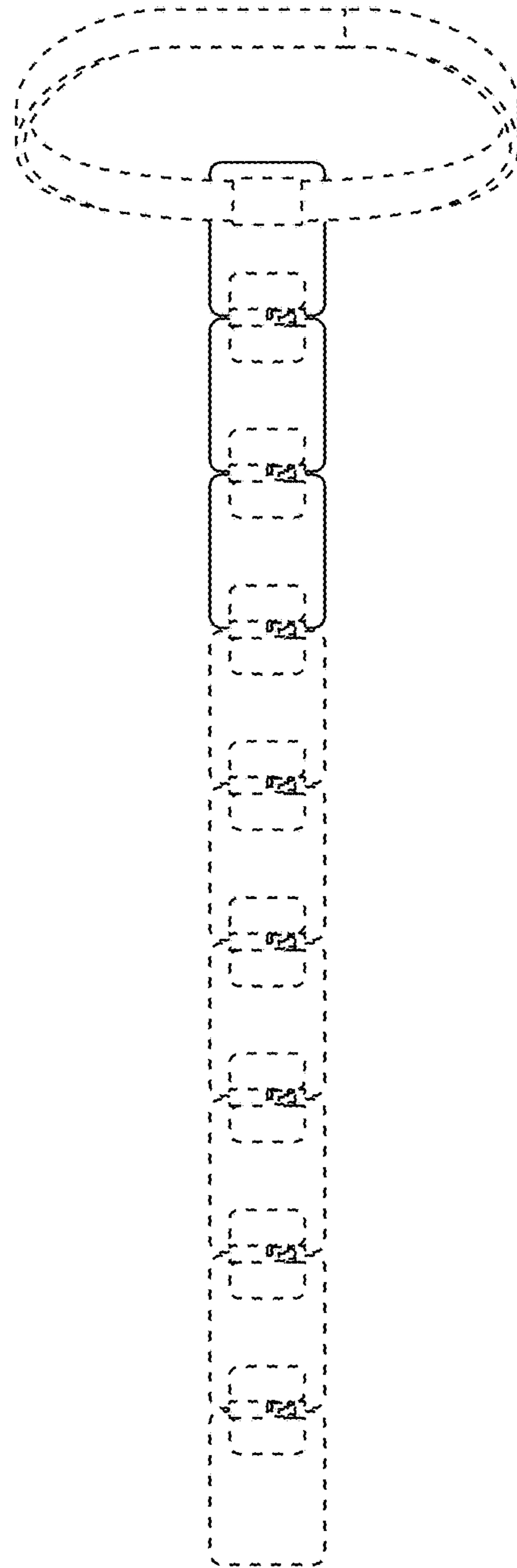
**FIG. 7**



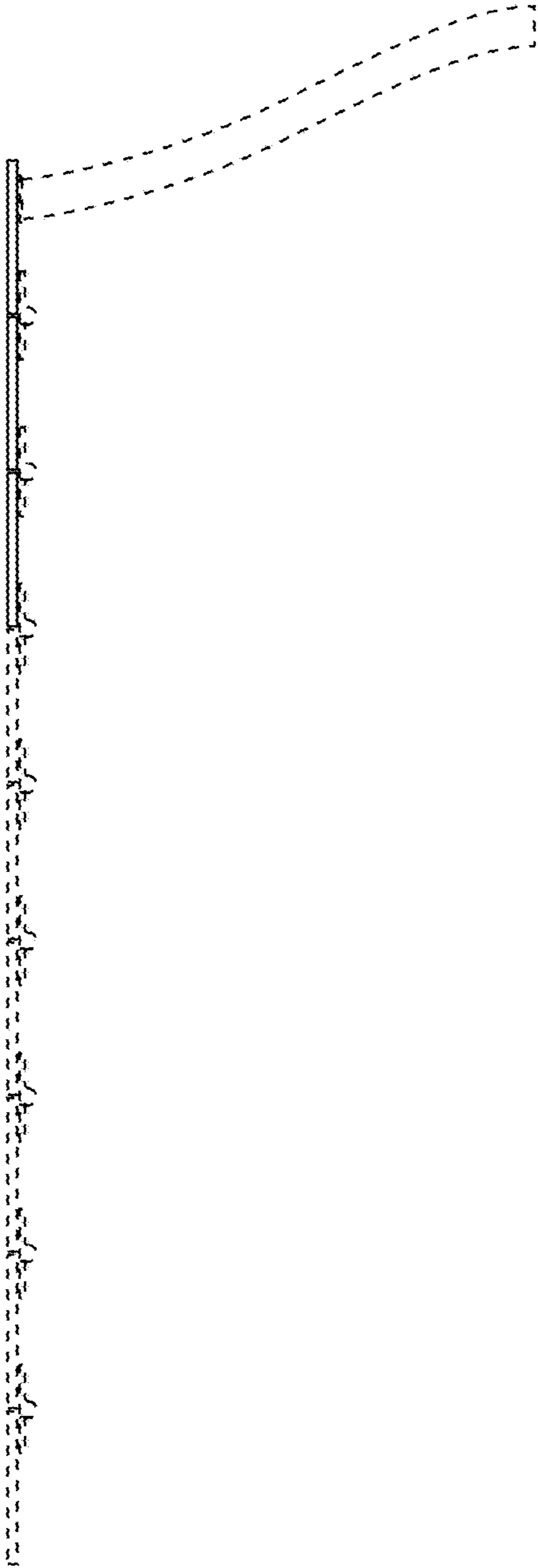
**FIG. 8**



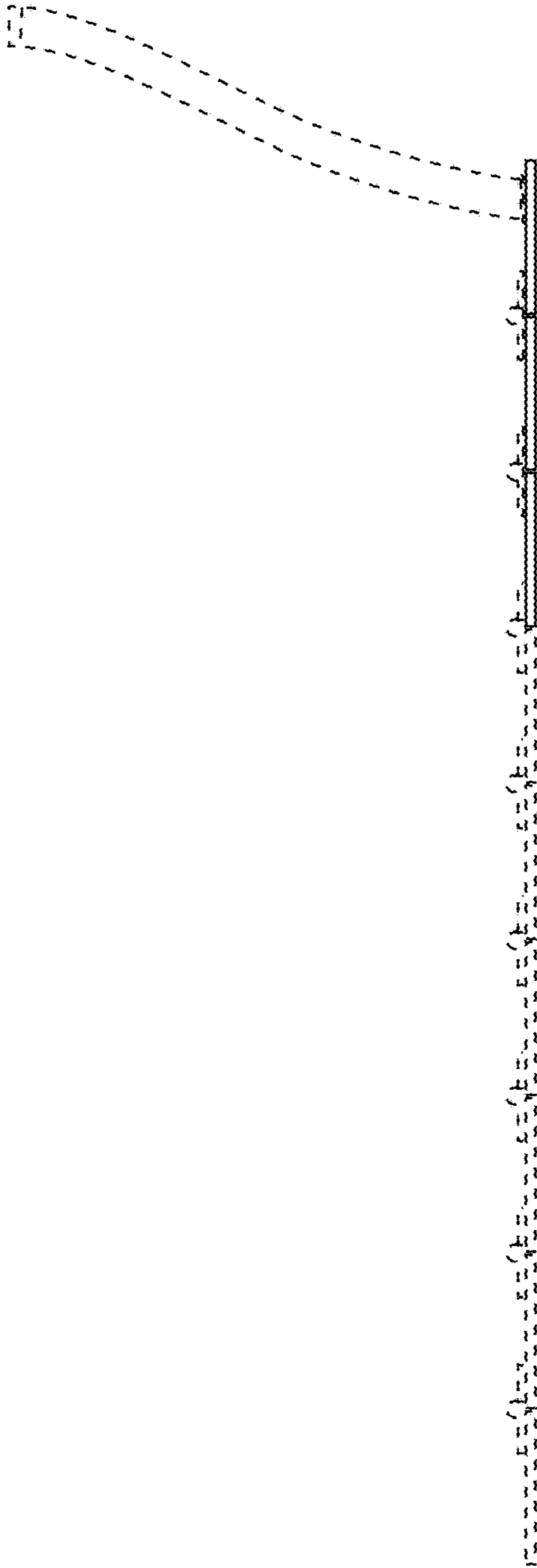
**FIG. 9**



**FIG. 10**

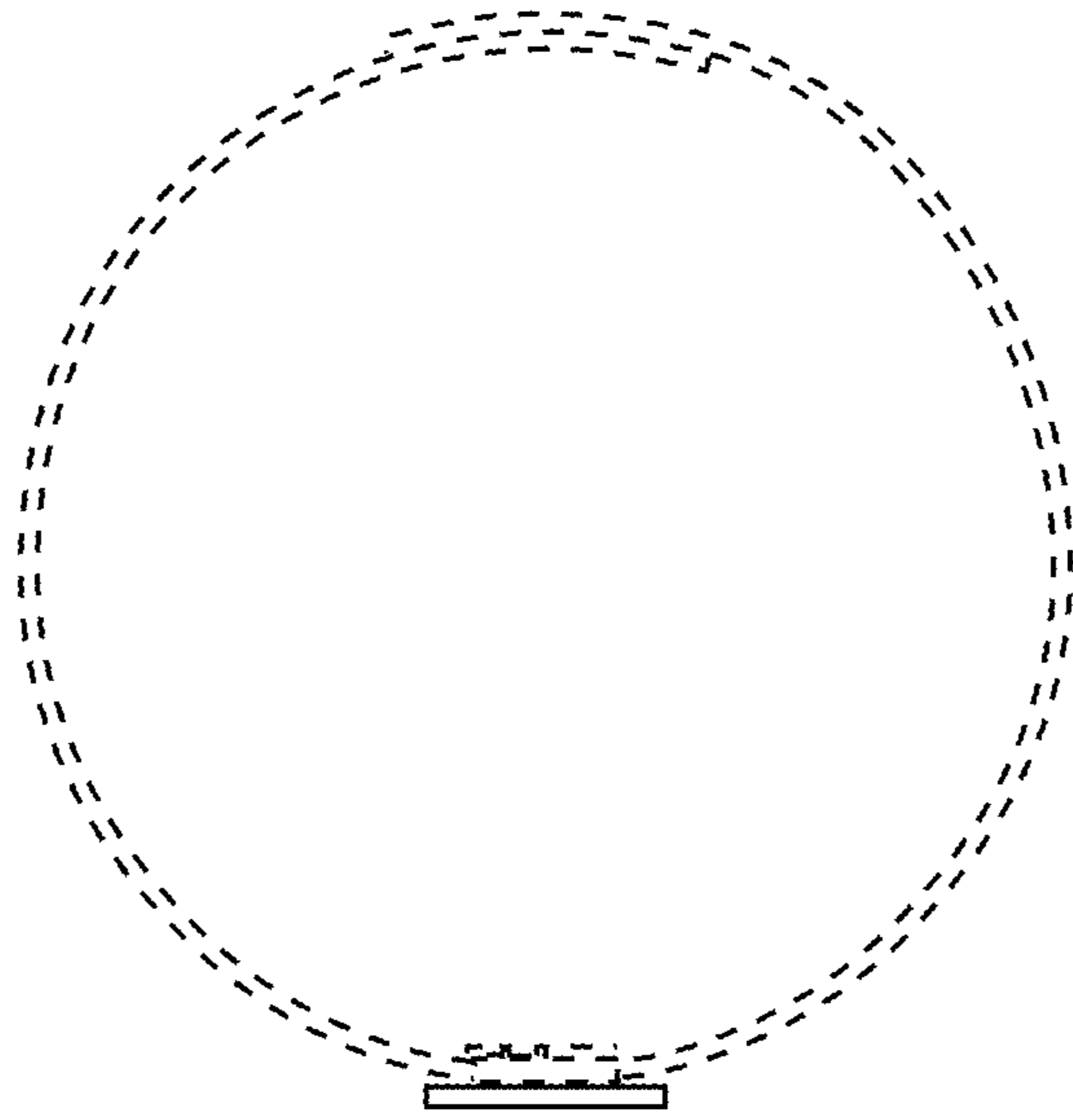


**FIG. 11**

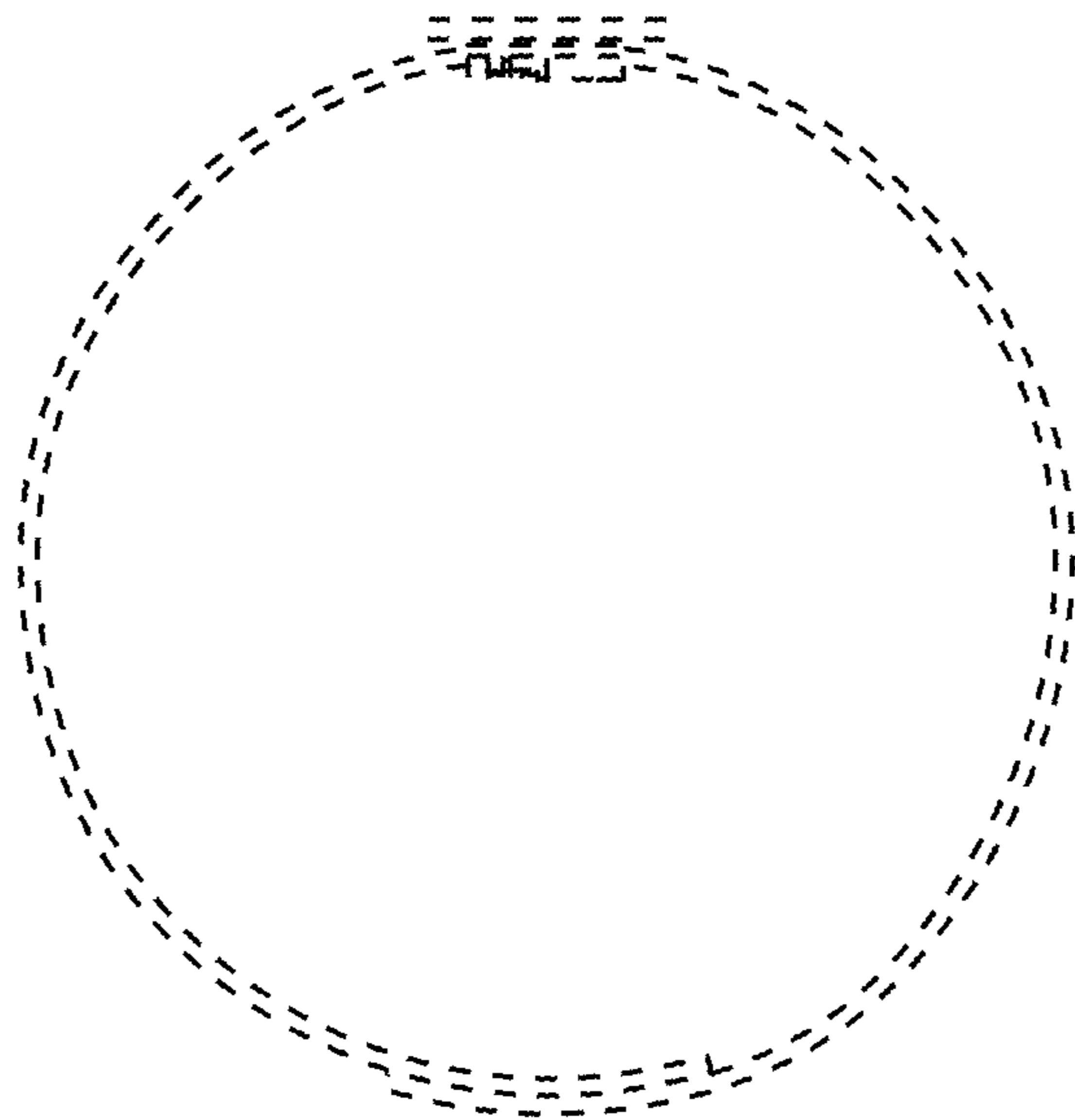


**FIG. 12**

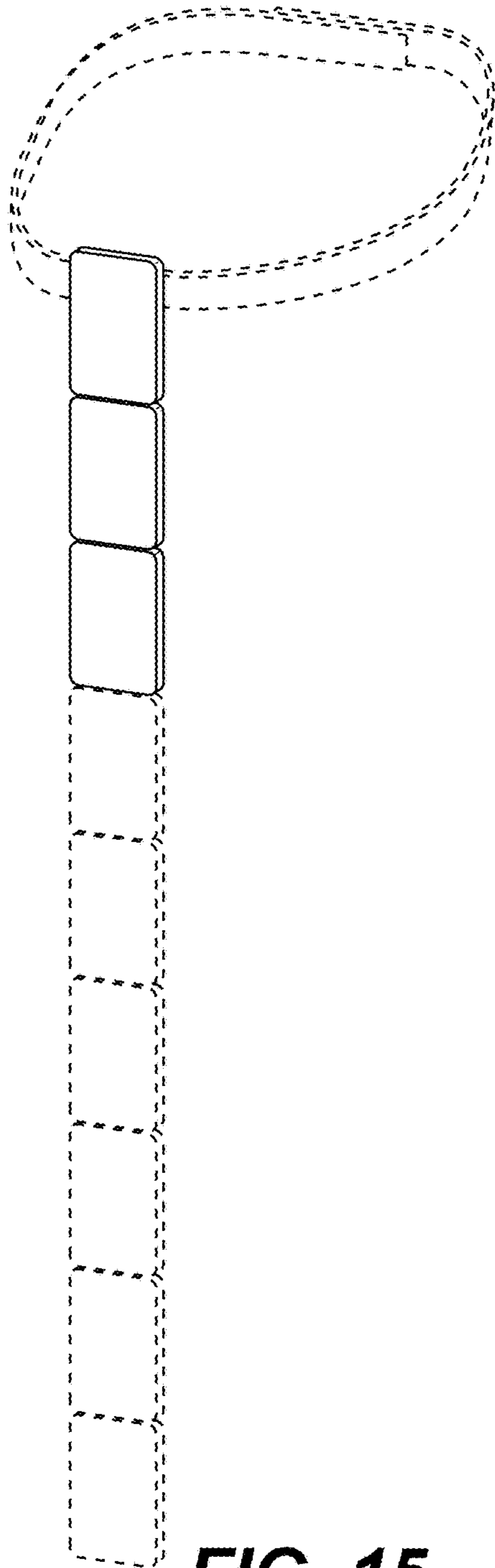




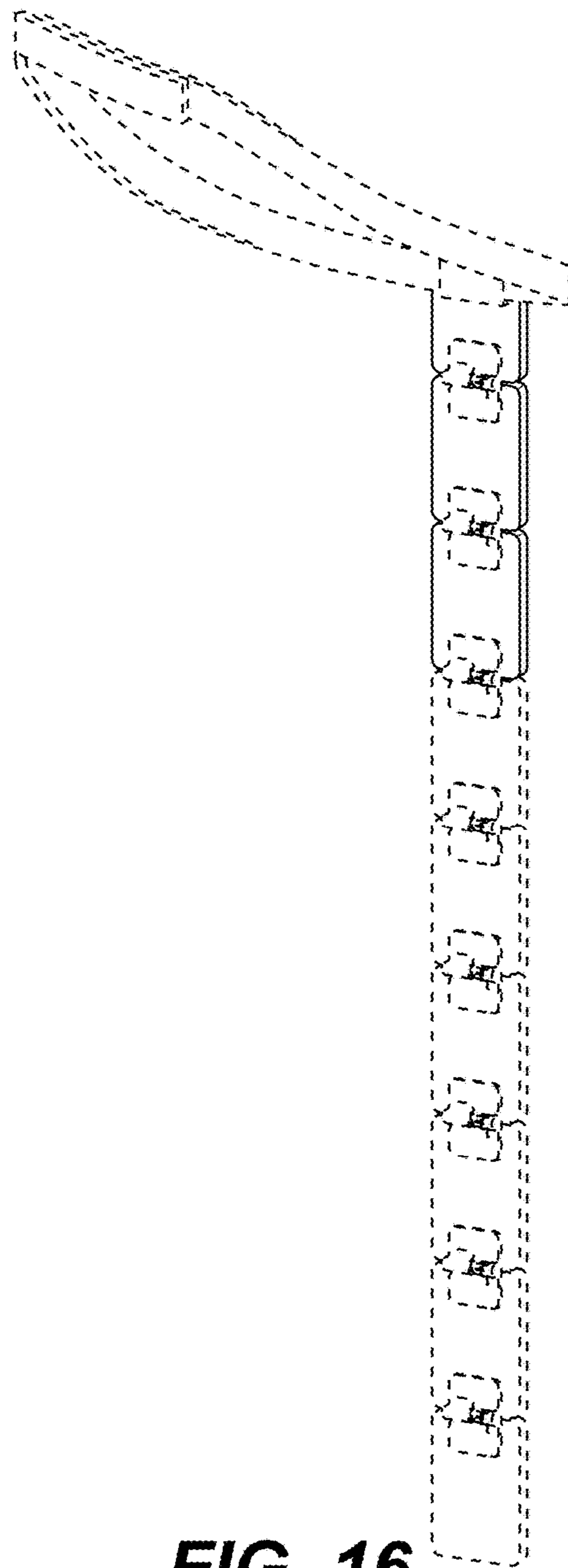
**FIG. 13**



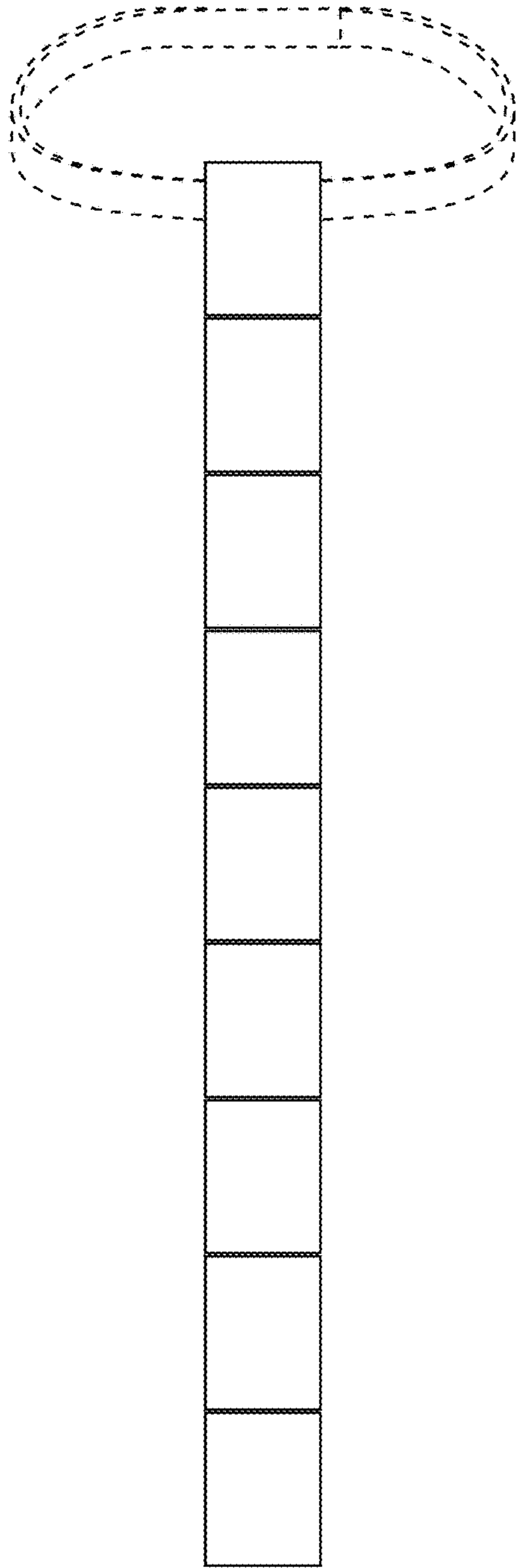
**FIG. 14**



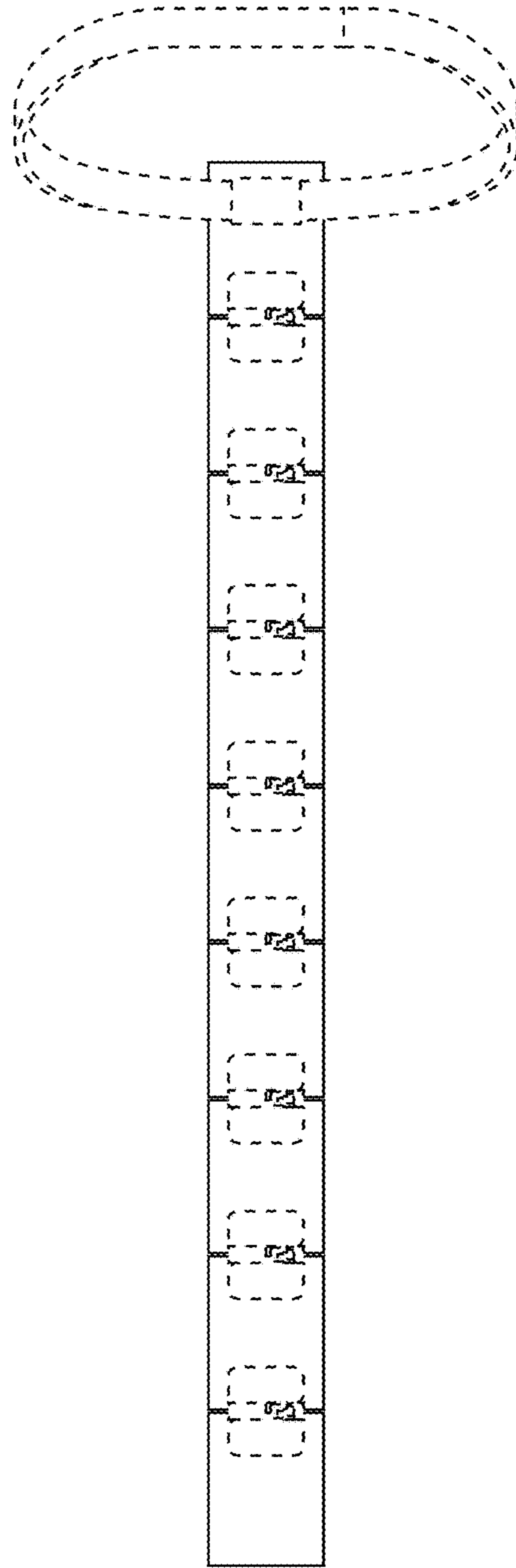
**FIG. 15**



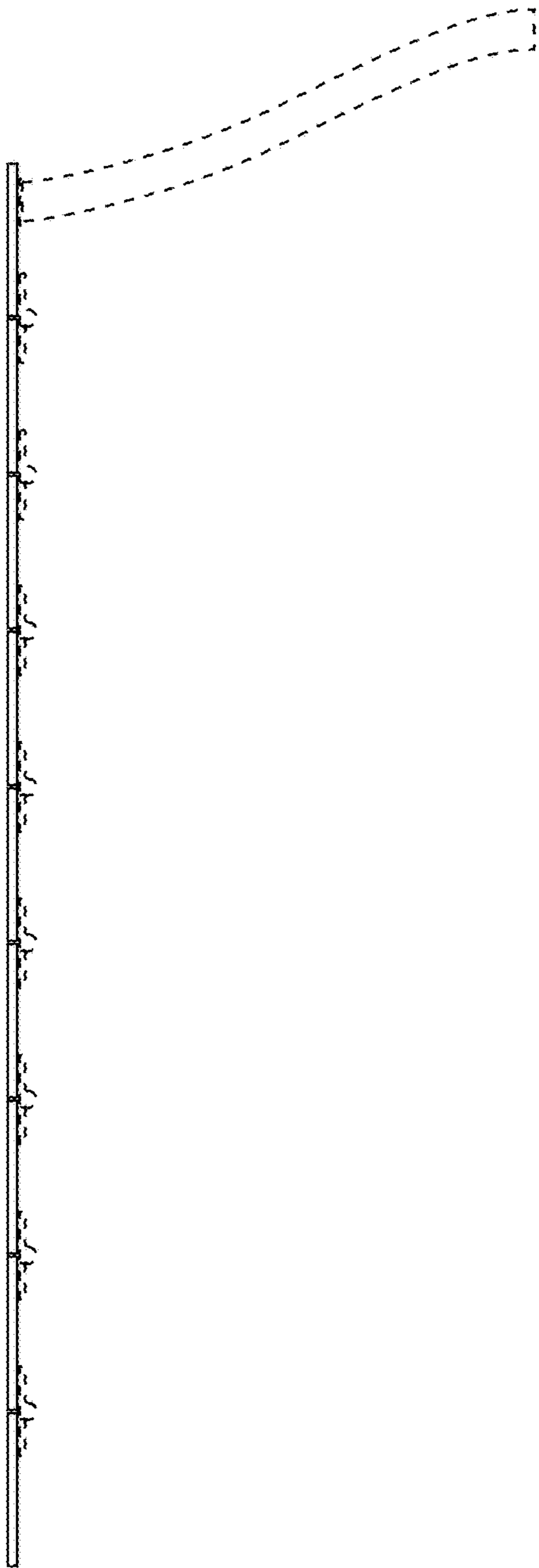
**FIG. 16**



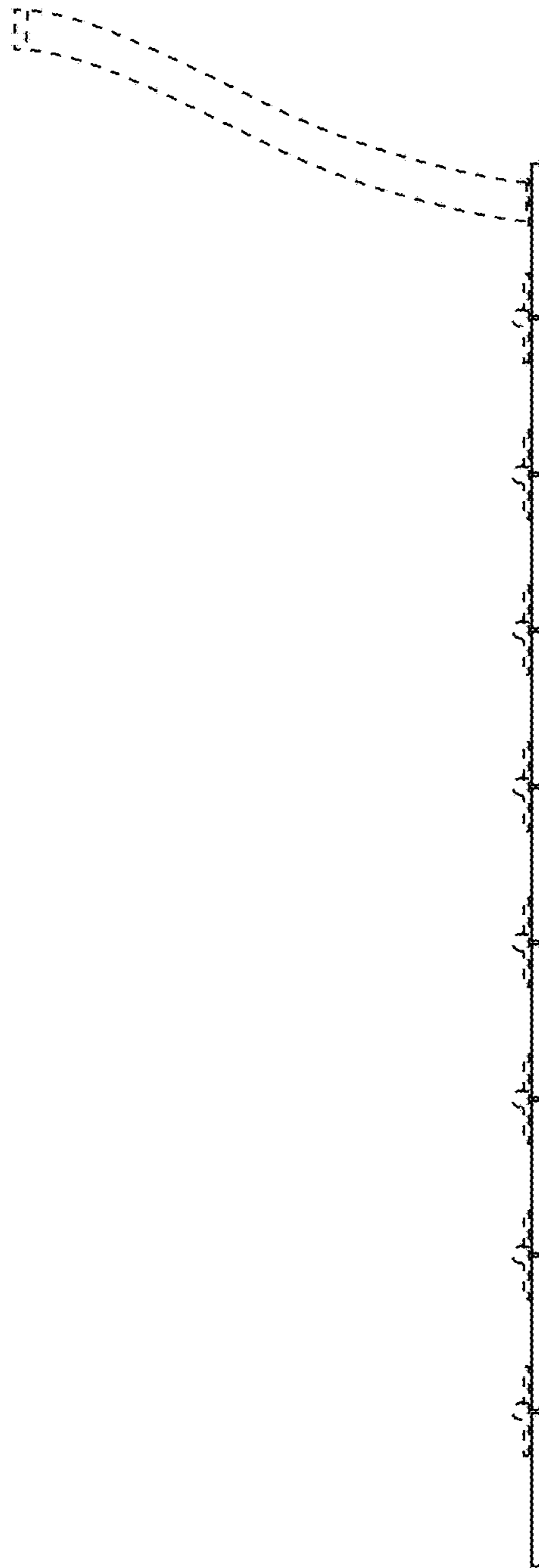
**FIG. 17**



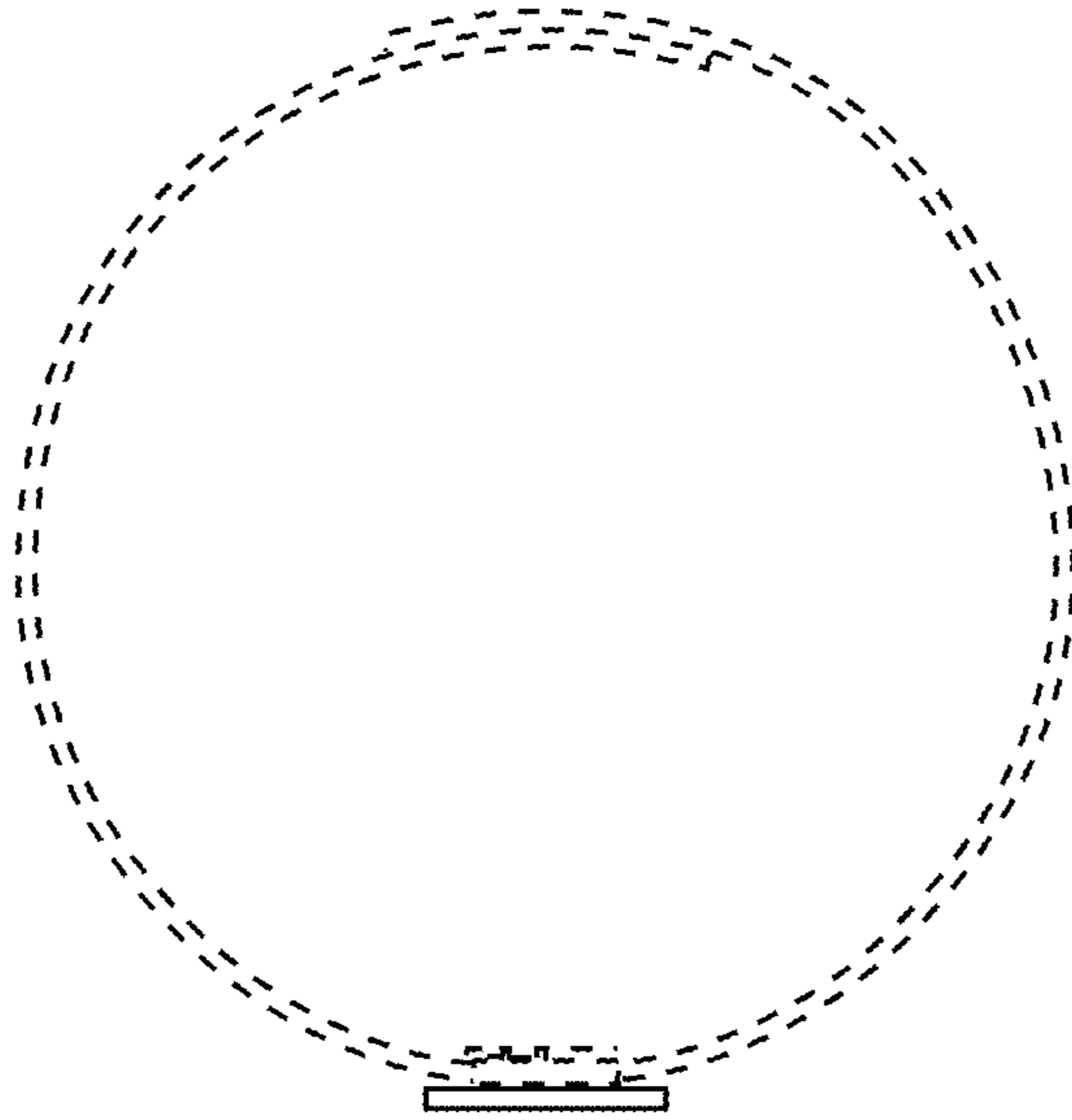
**FIG. 18**



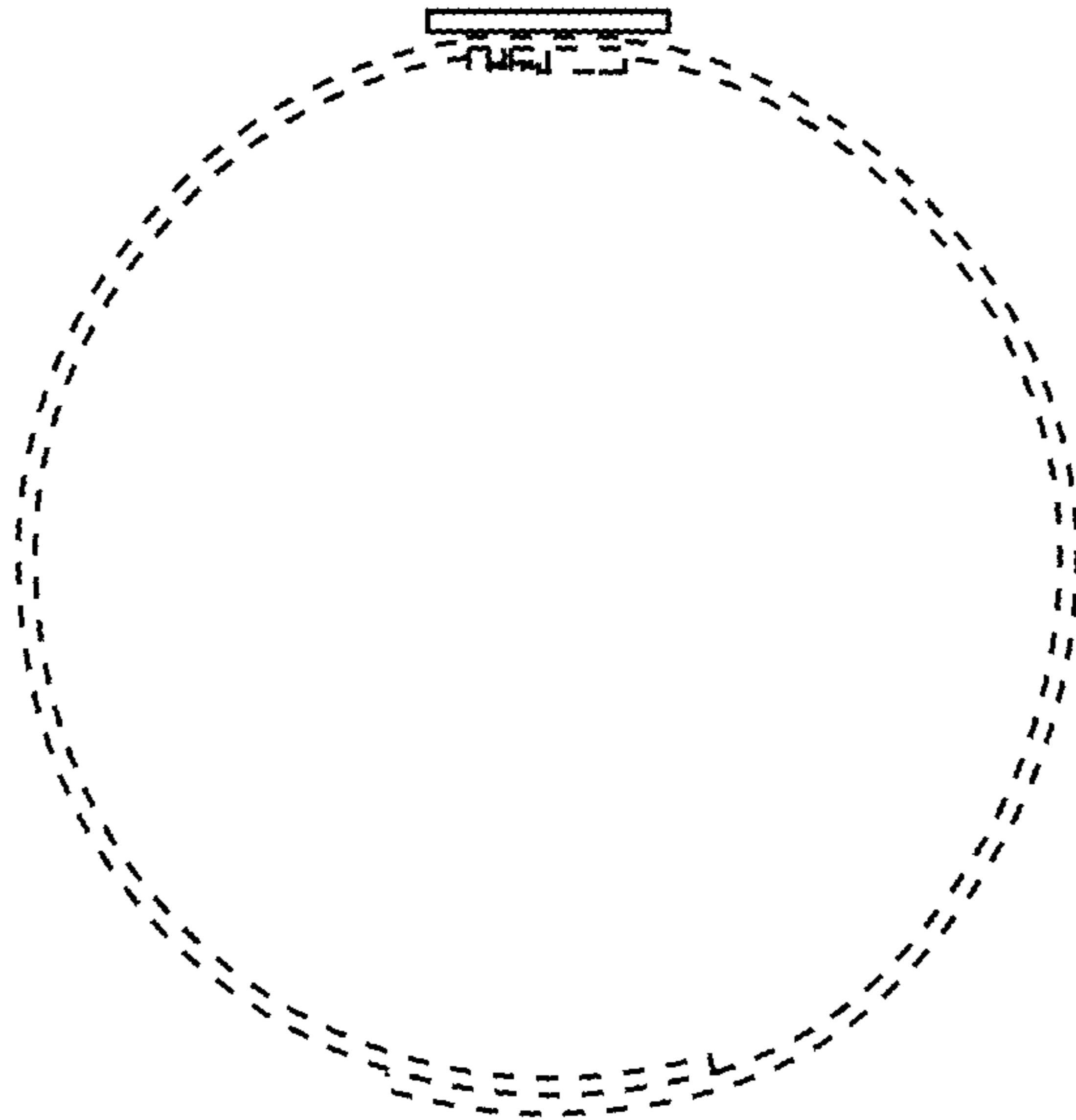
**FIG. 19**



**FIG. 20**

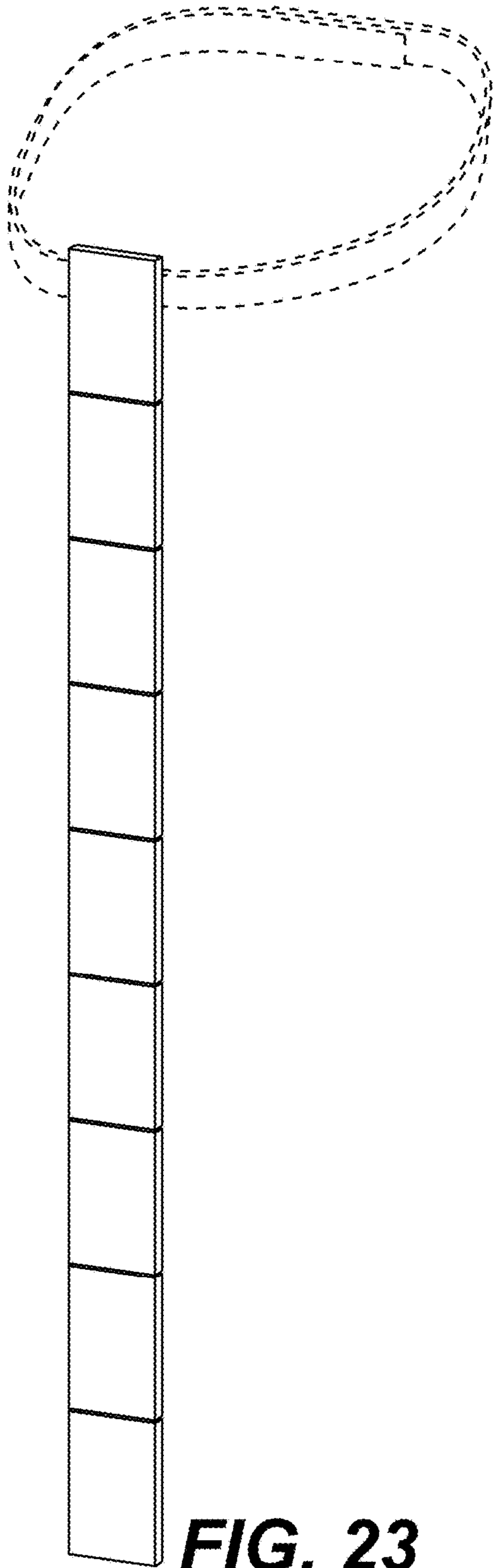


**FIG. 21**

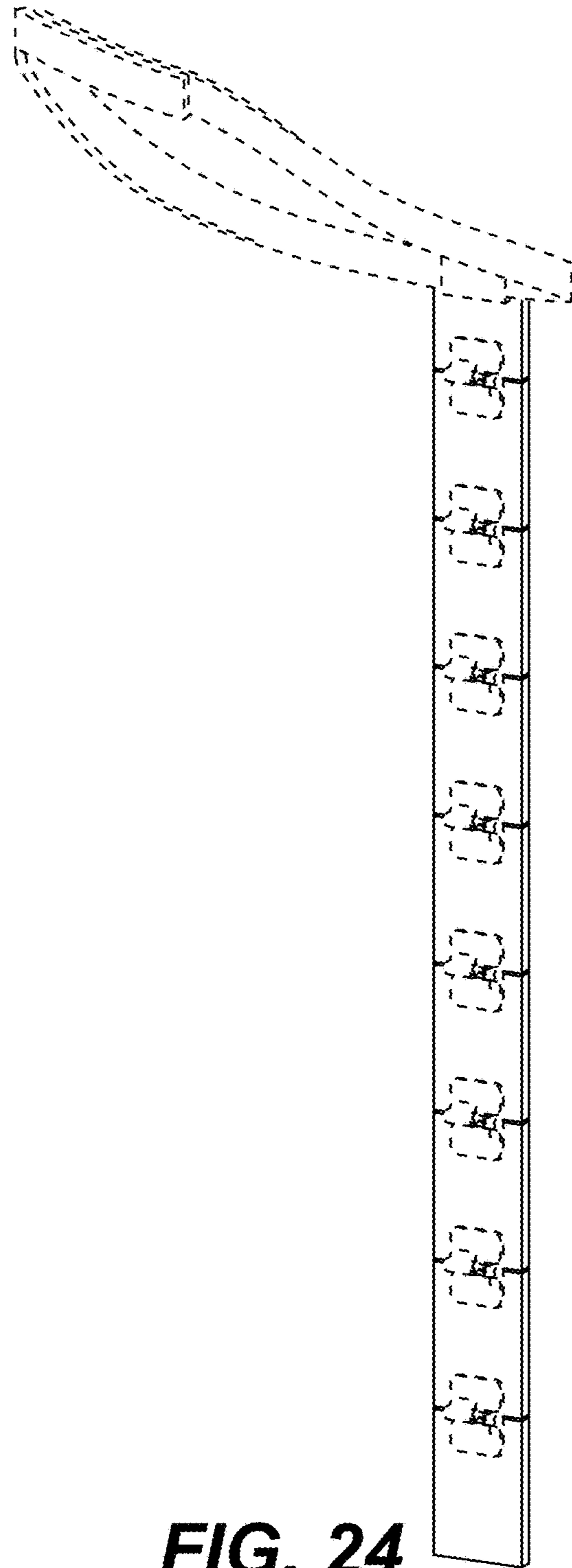


**FIG. 22**

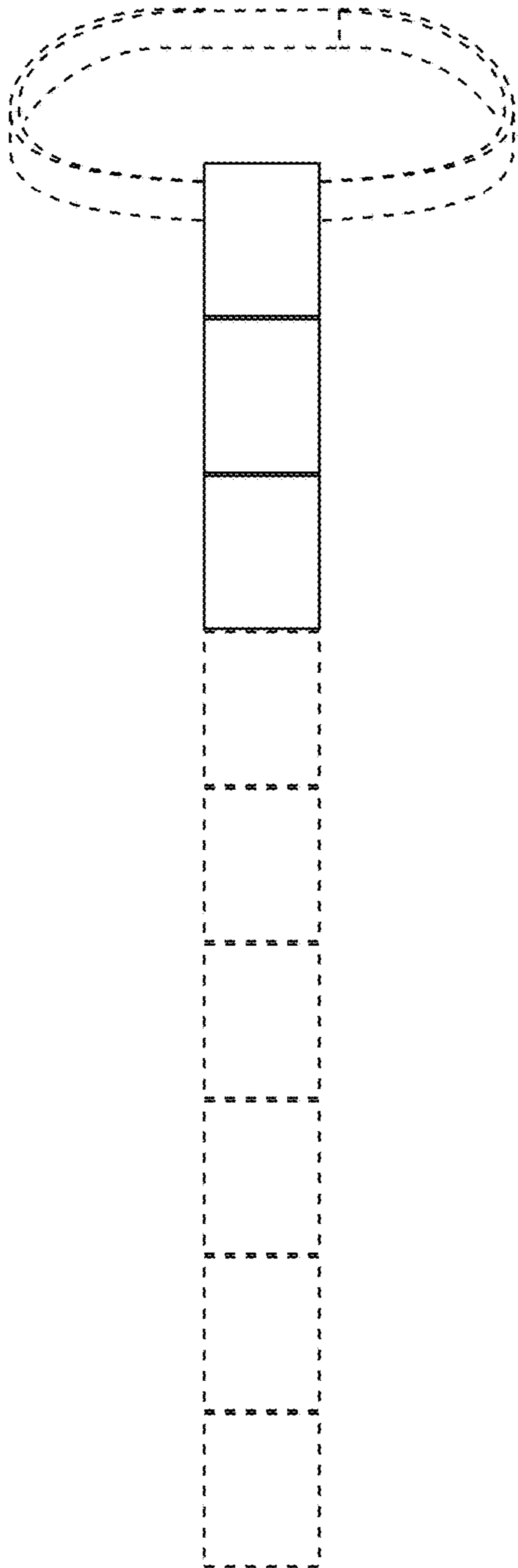




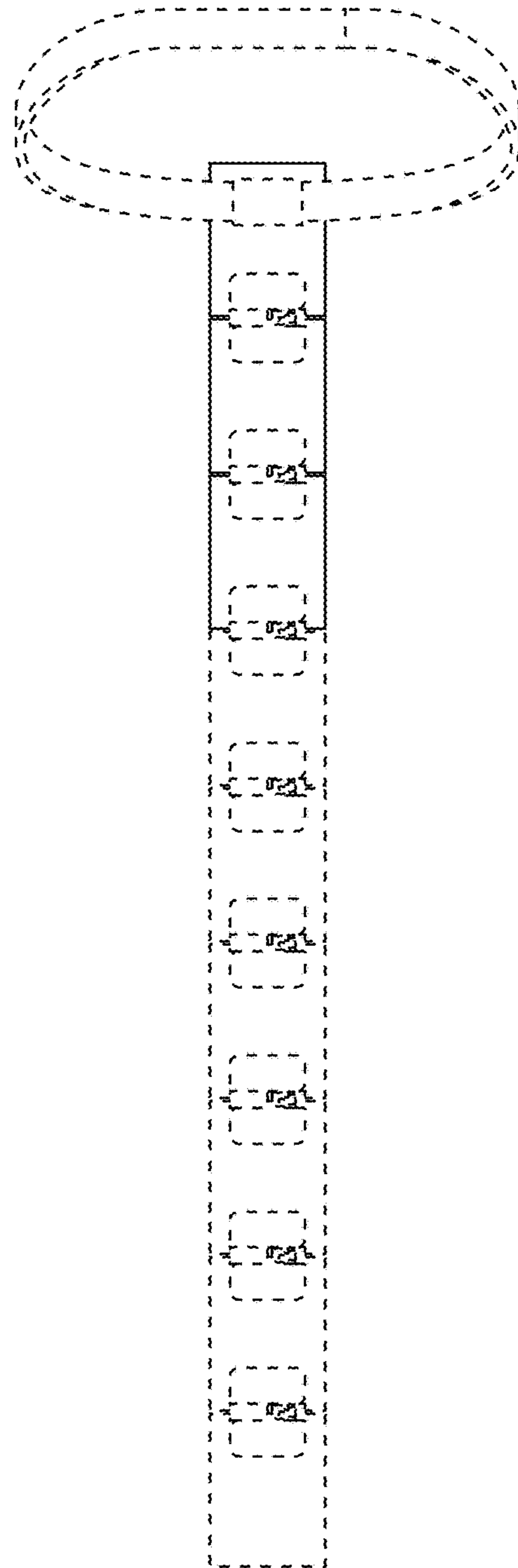
**FIG. 23**



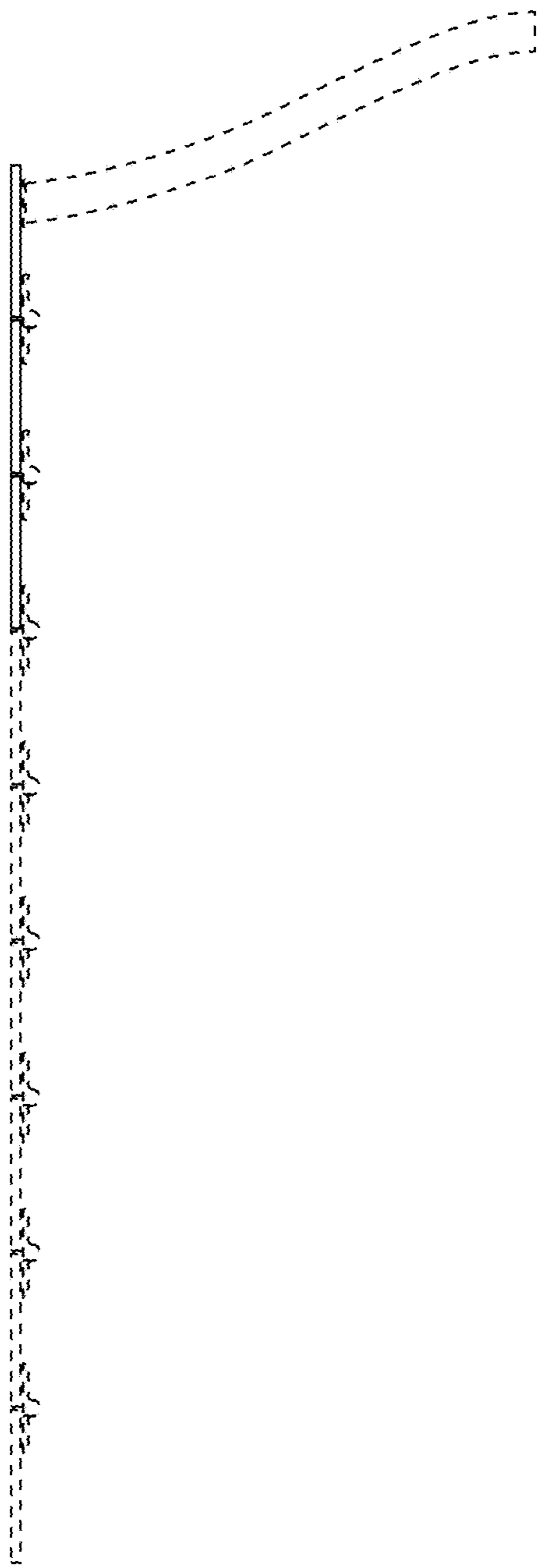
**FIG. 24**



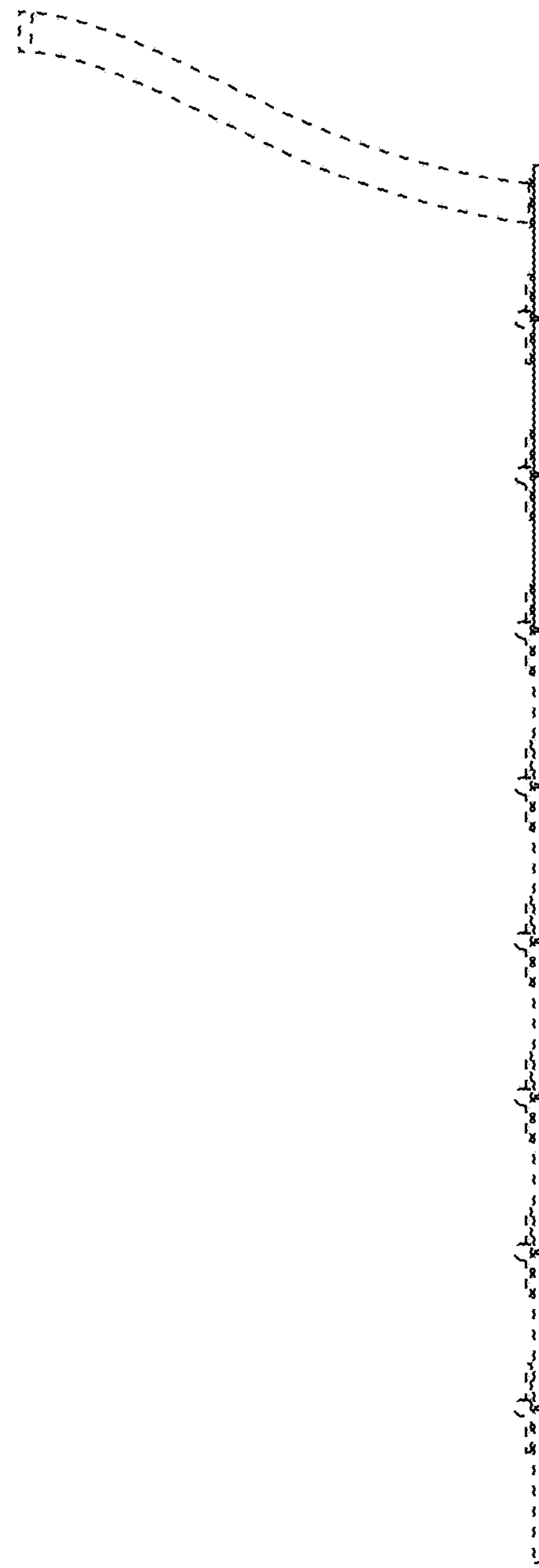
**FIG. 25**



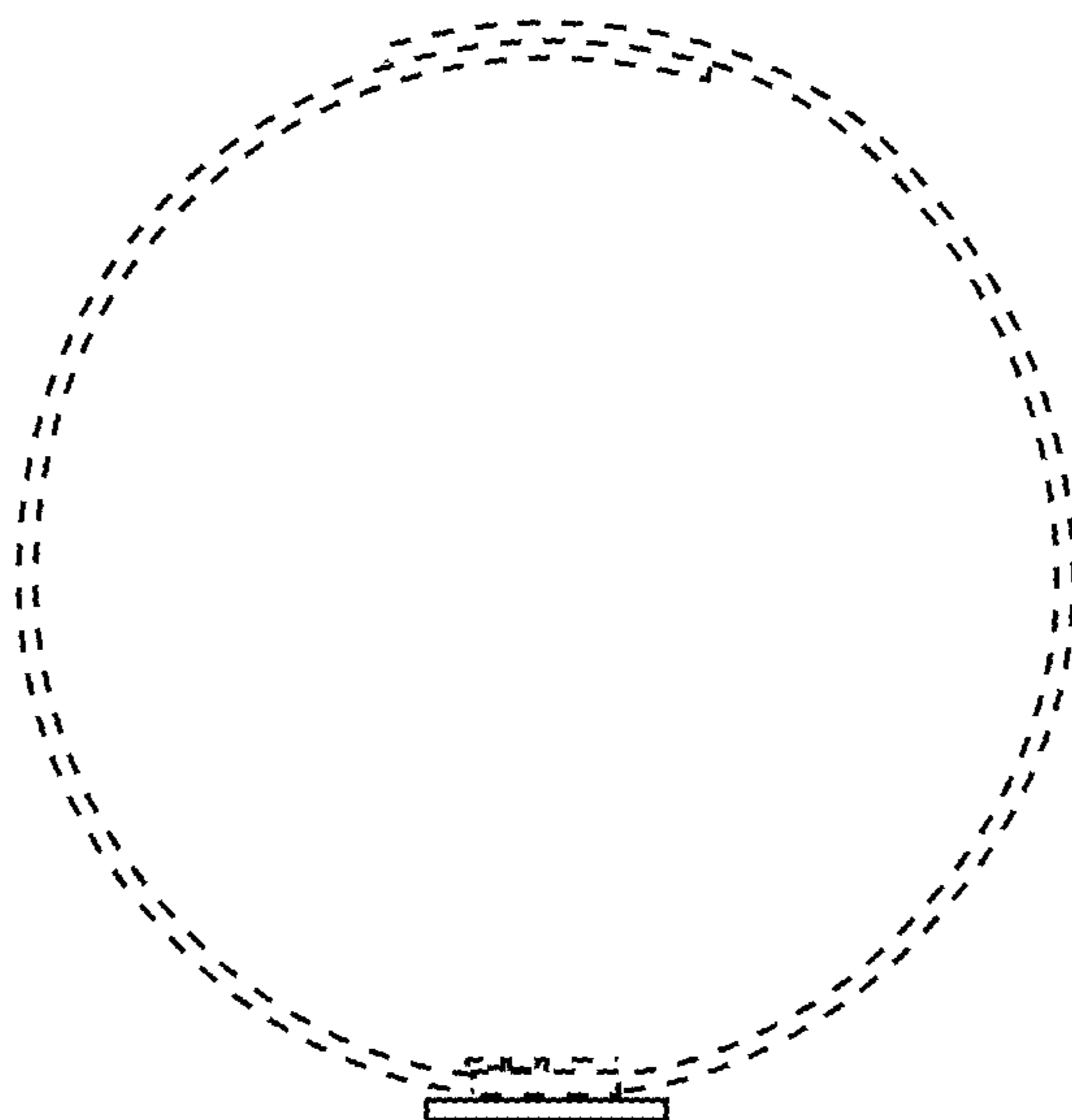
**FIG. 26**



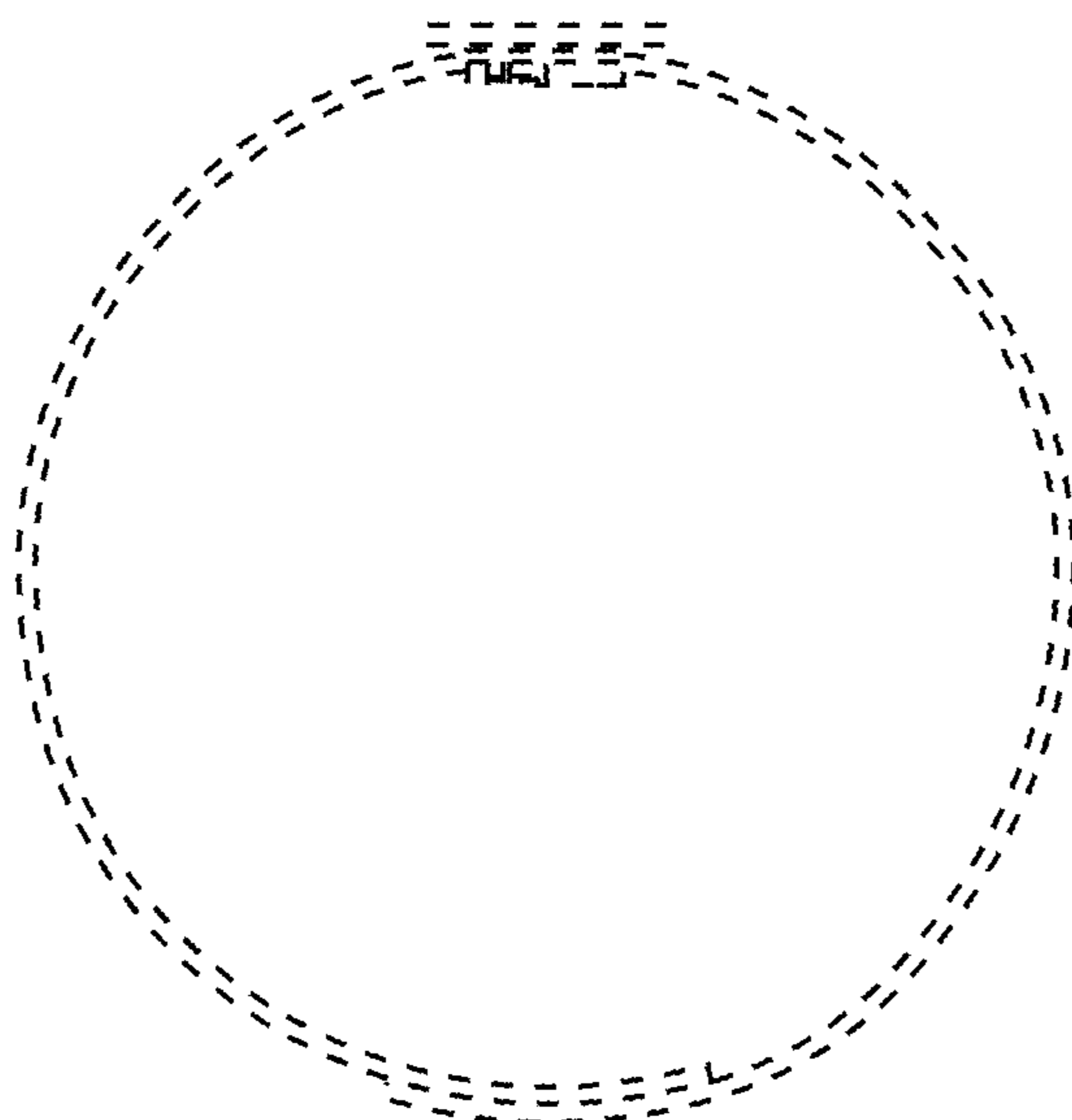
**FIG. 27**



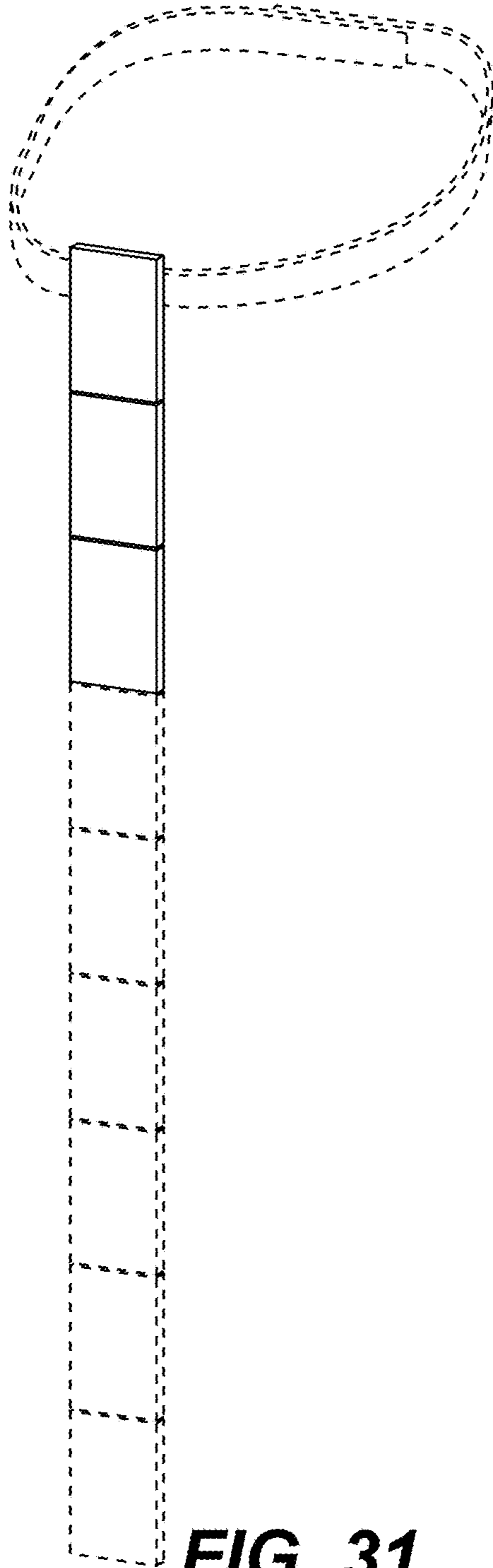
**FIG. 28**



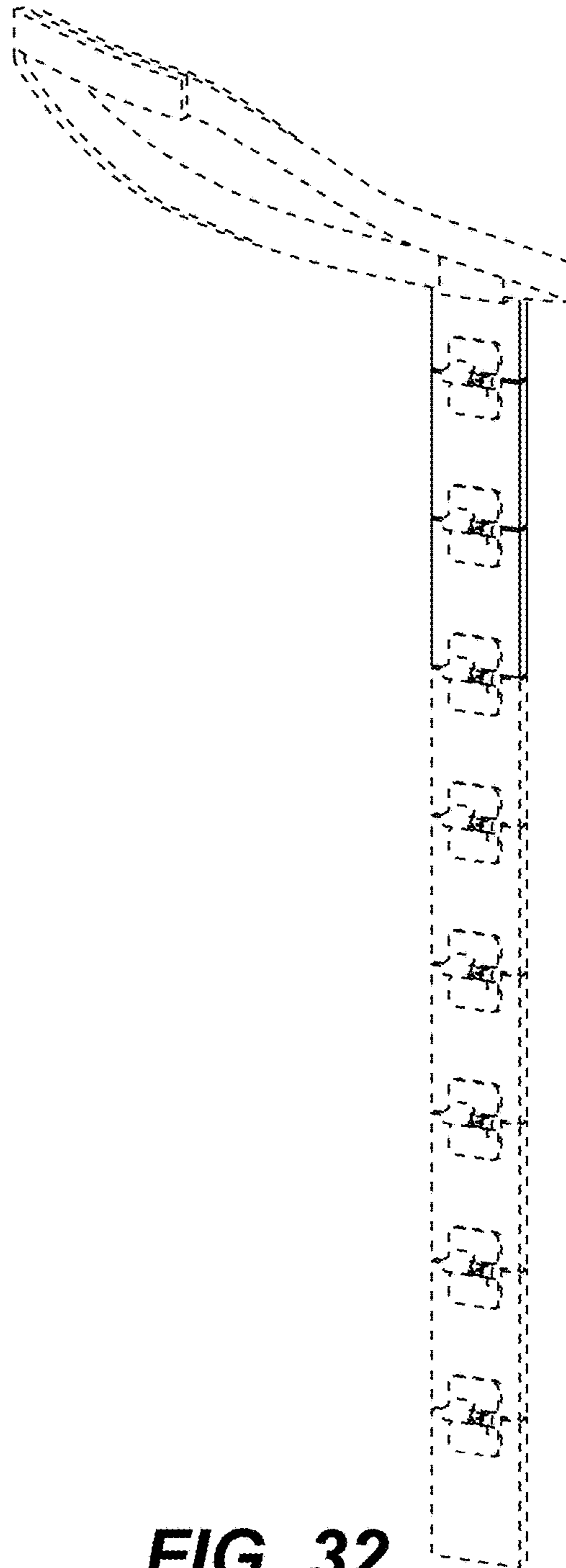
**FIG. 29**



**FIG. 30**

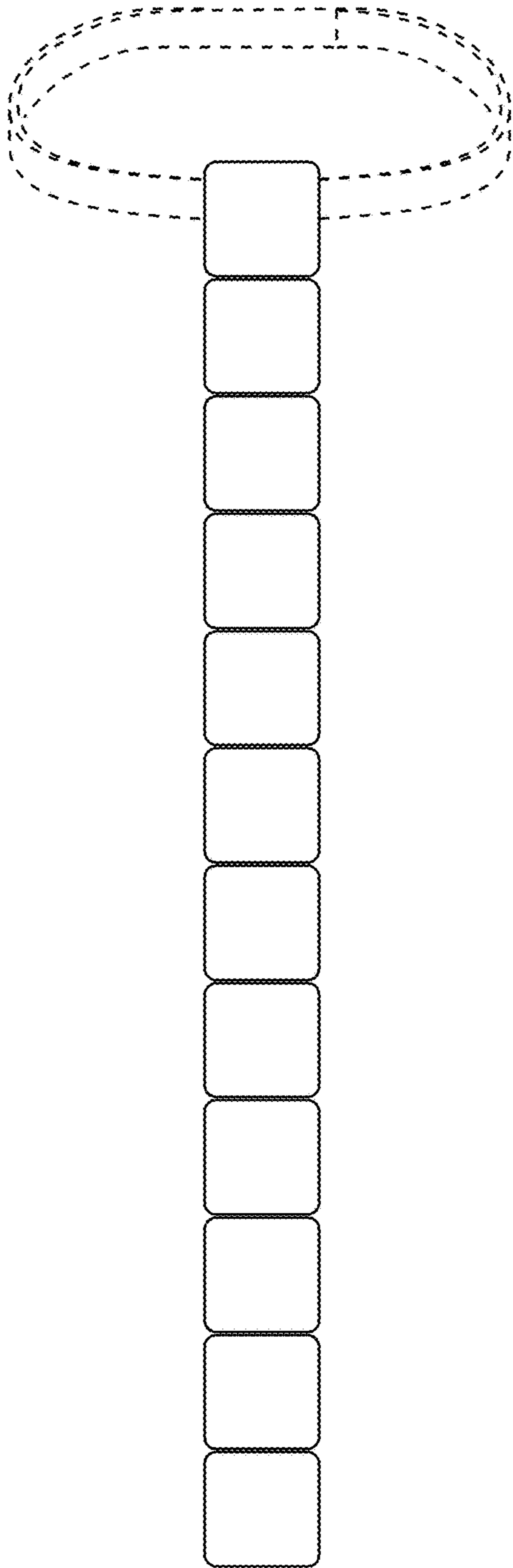


**FIG. 31**

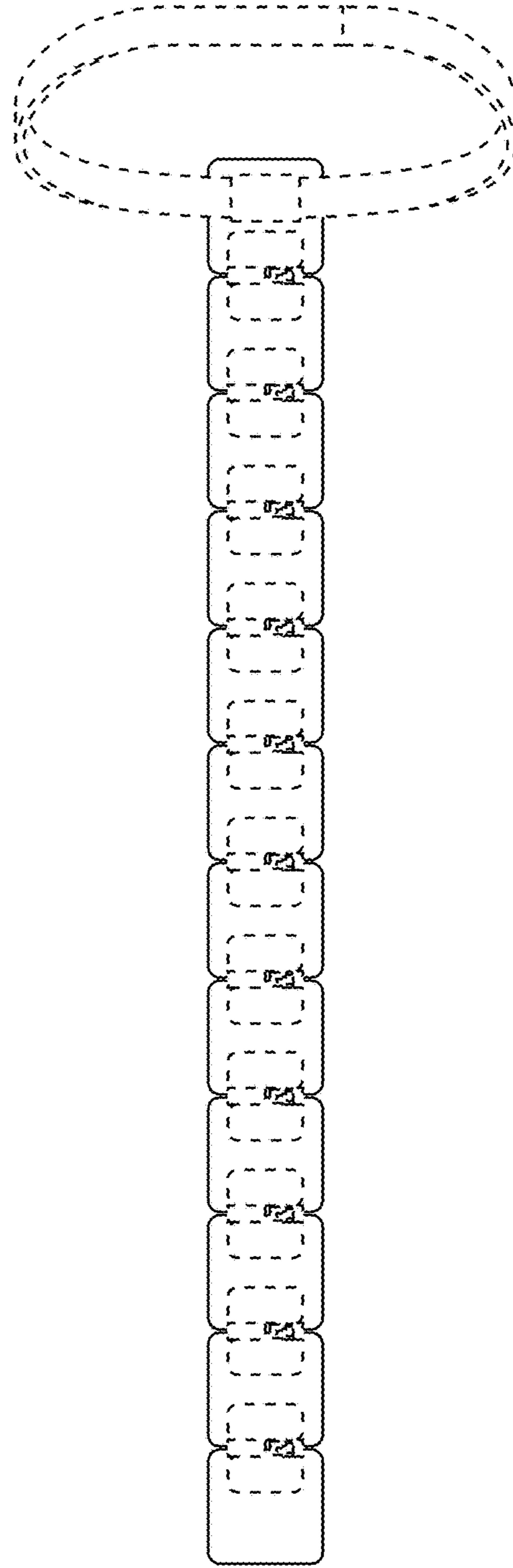


**FIG. 32**

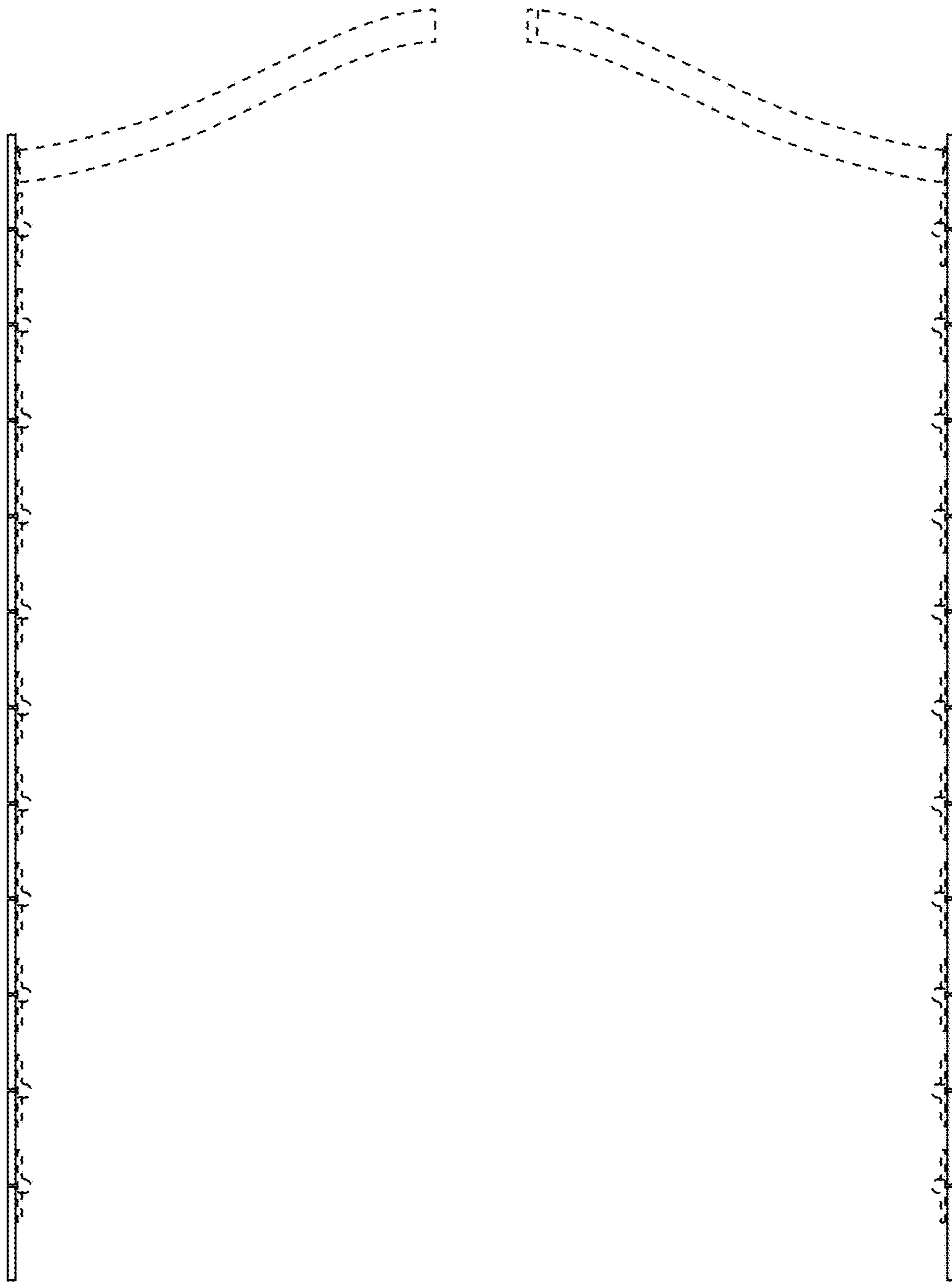




**FIG. 33**

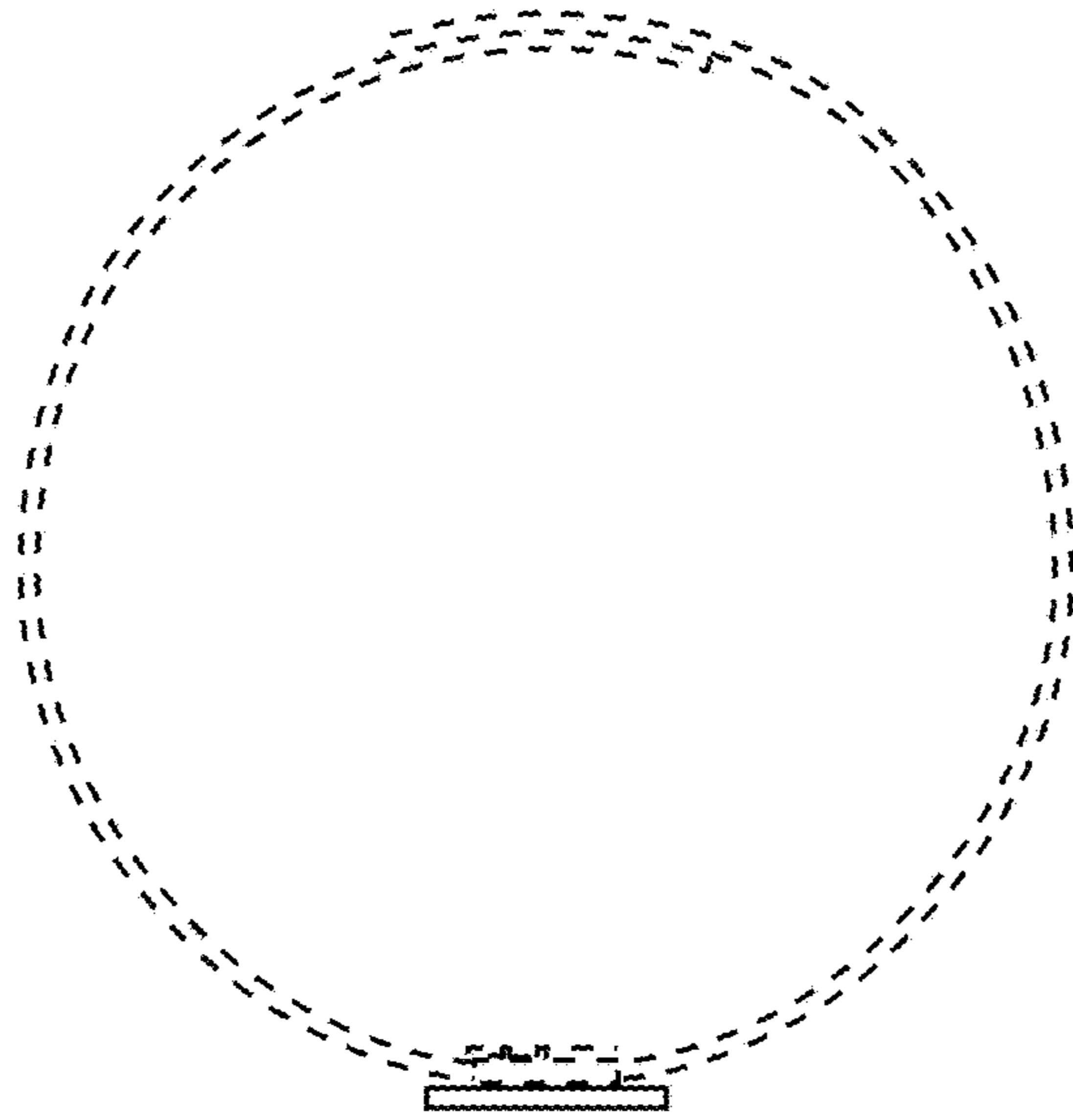


**FIG. 34**

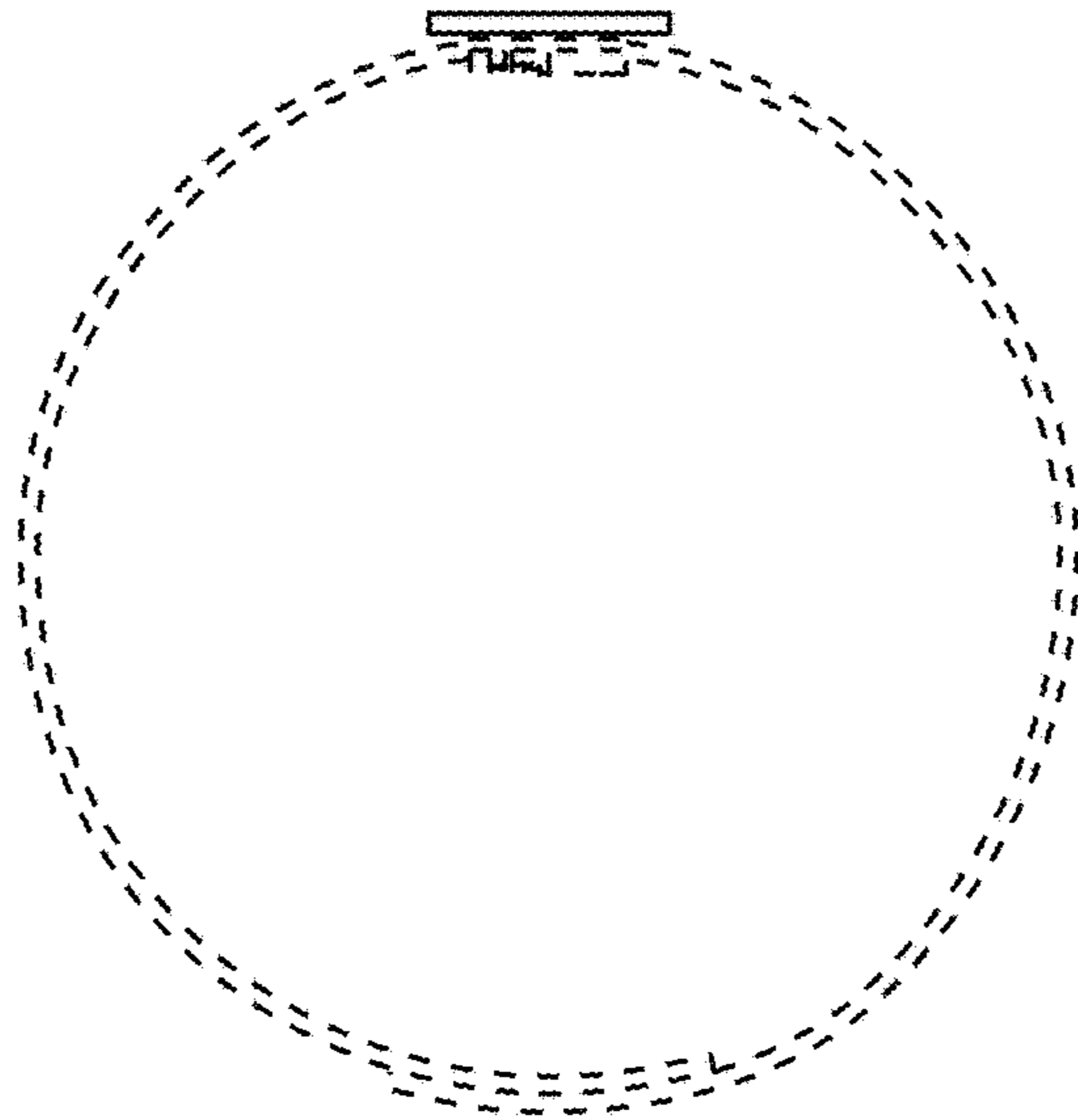


**FIG. 35**

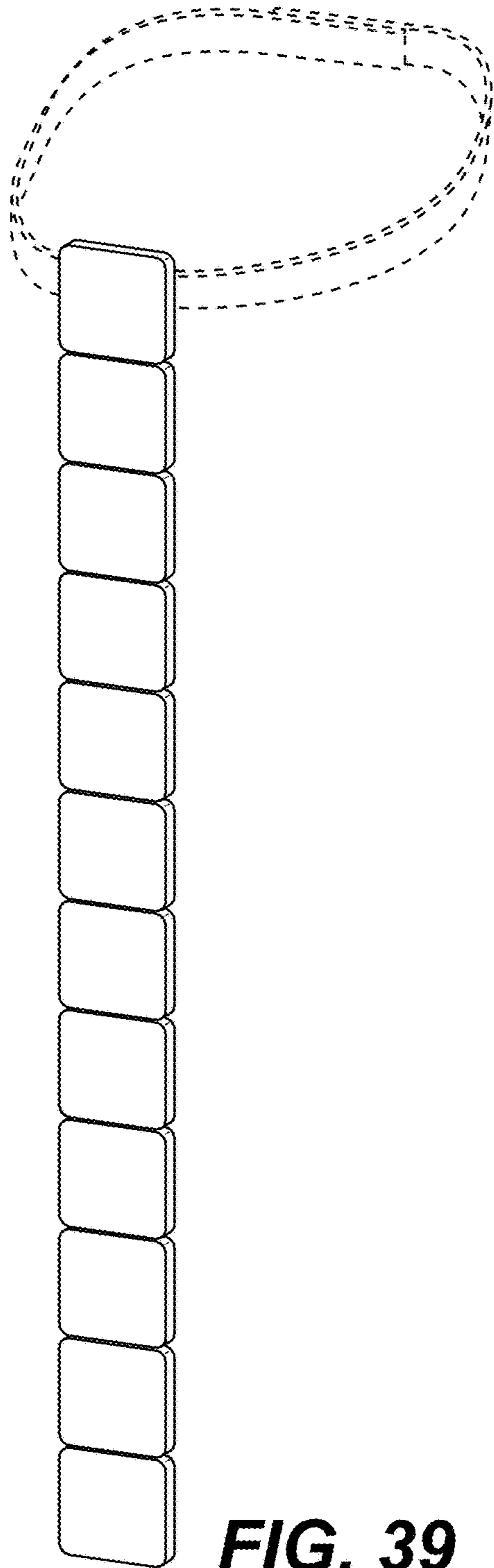
**FIG. 36**



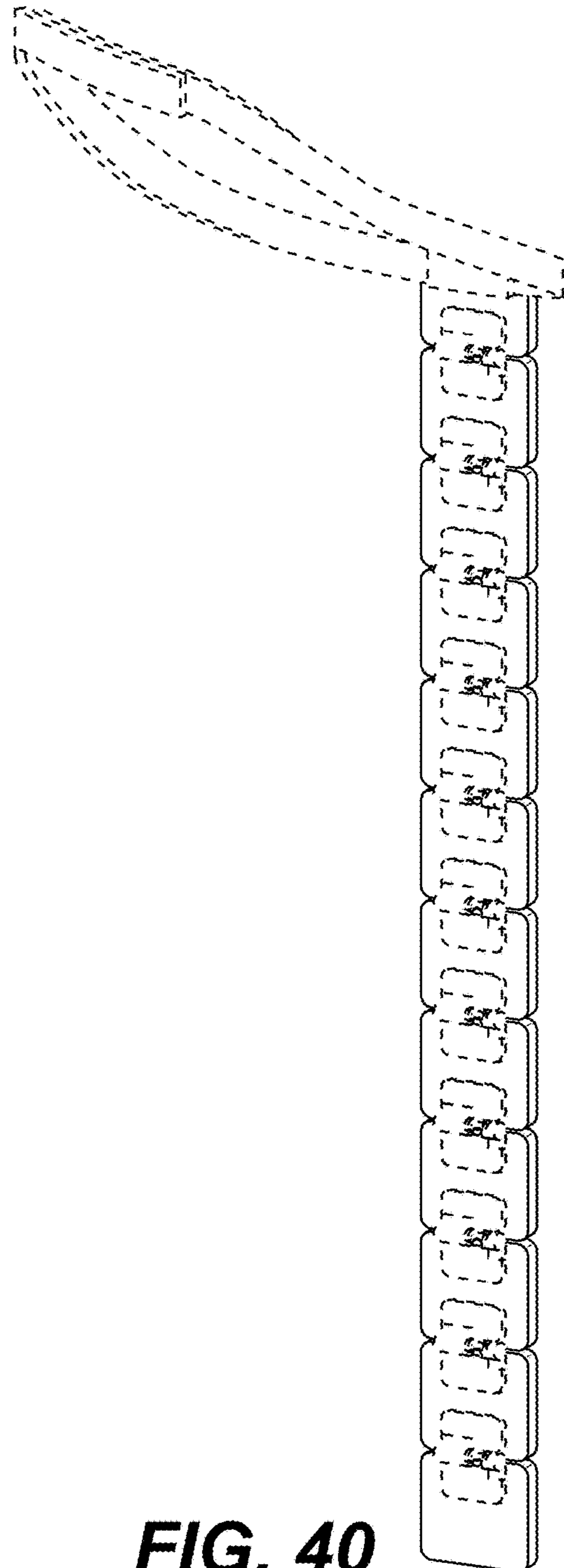
**FIG. 37**



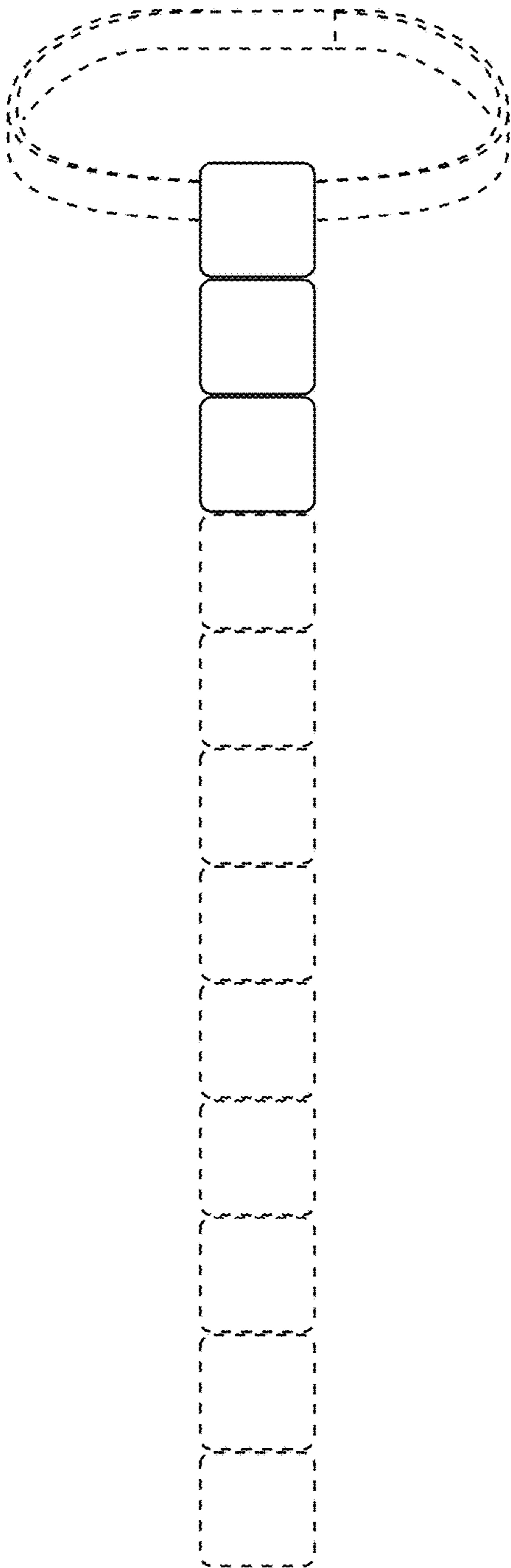
**FIG. 38**



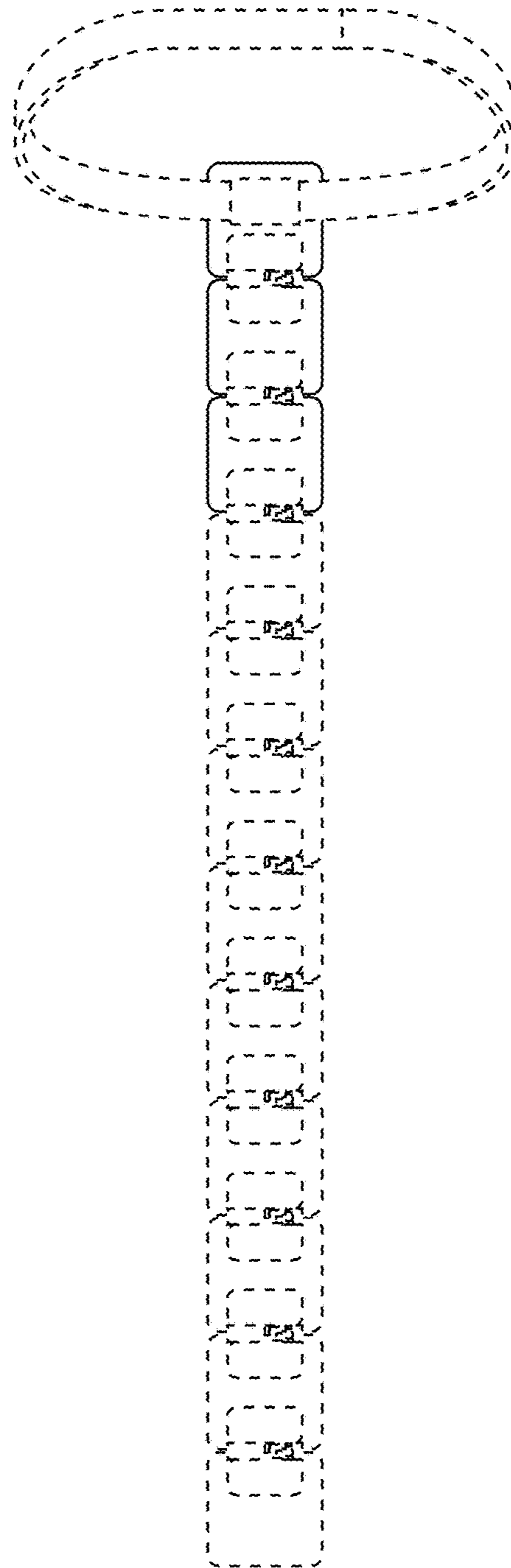
**FIG. 39**



**FIG. 40**

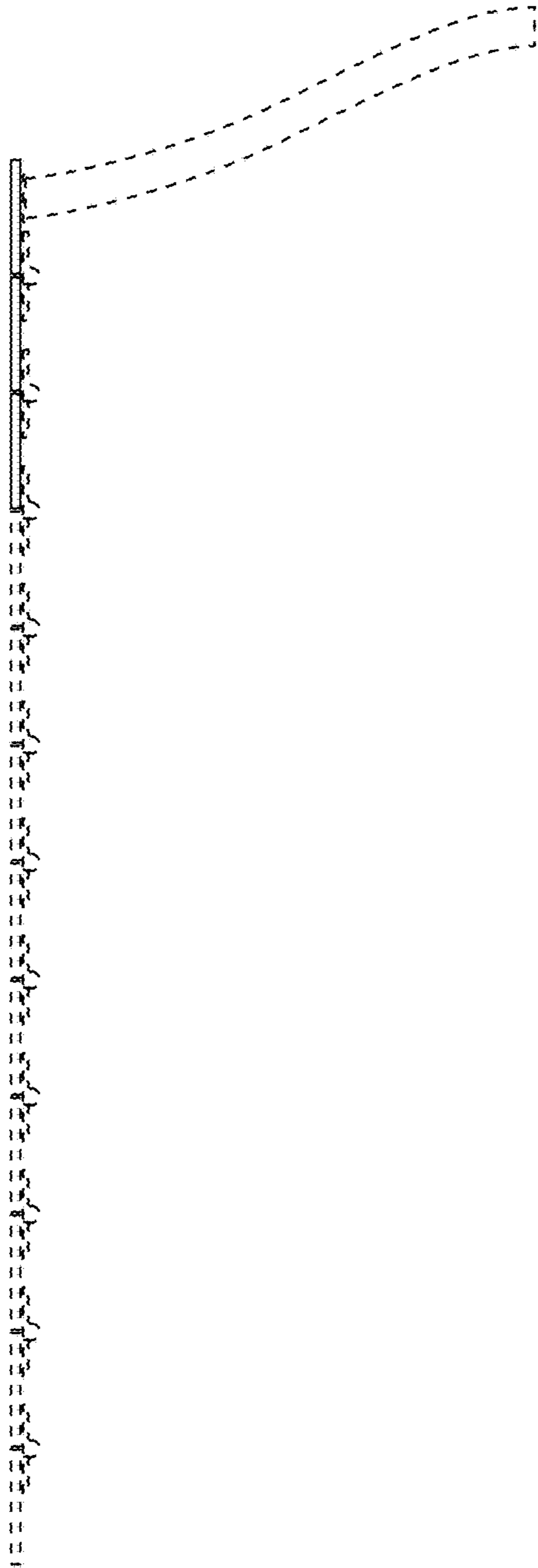


**FIG. 41**

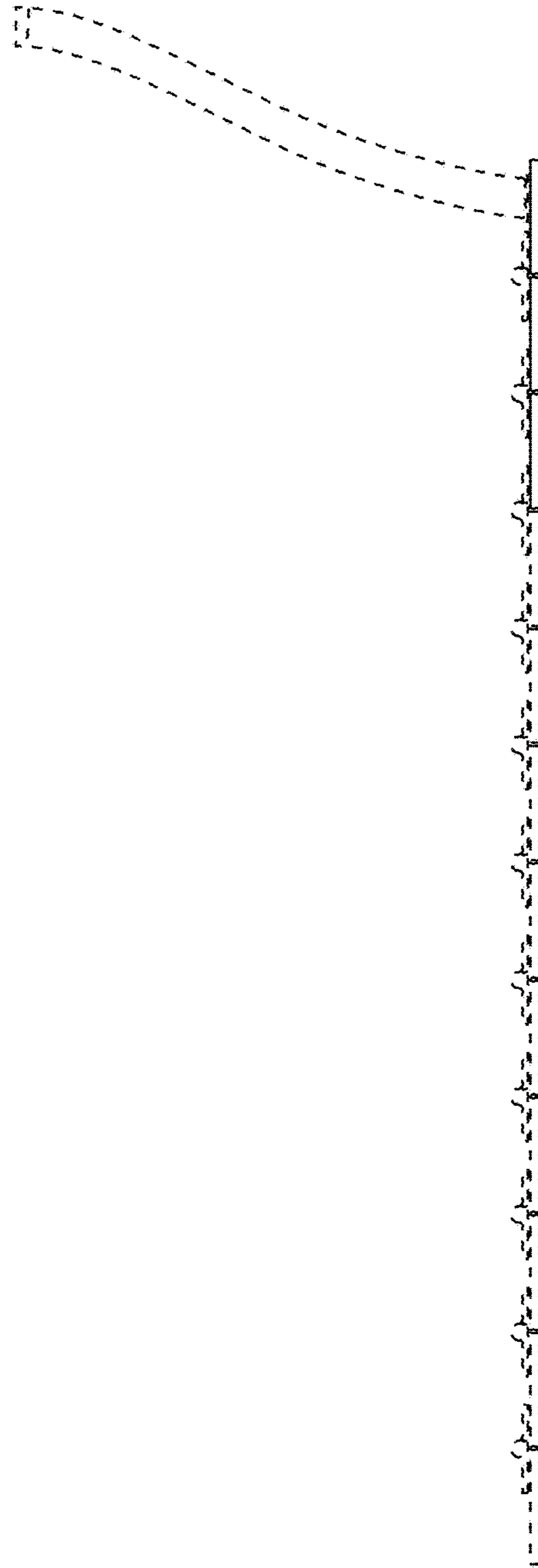


**FIG. 42**

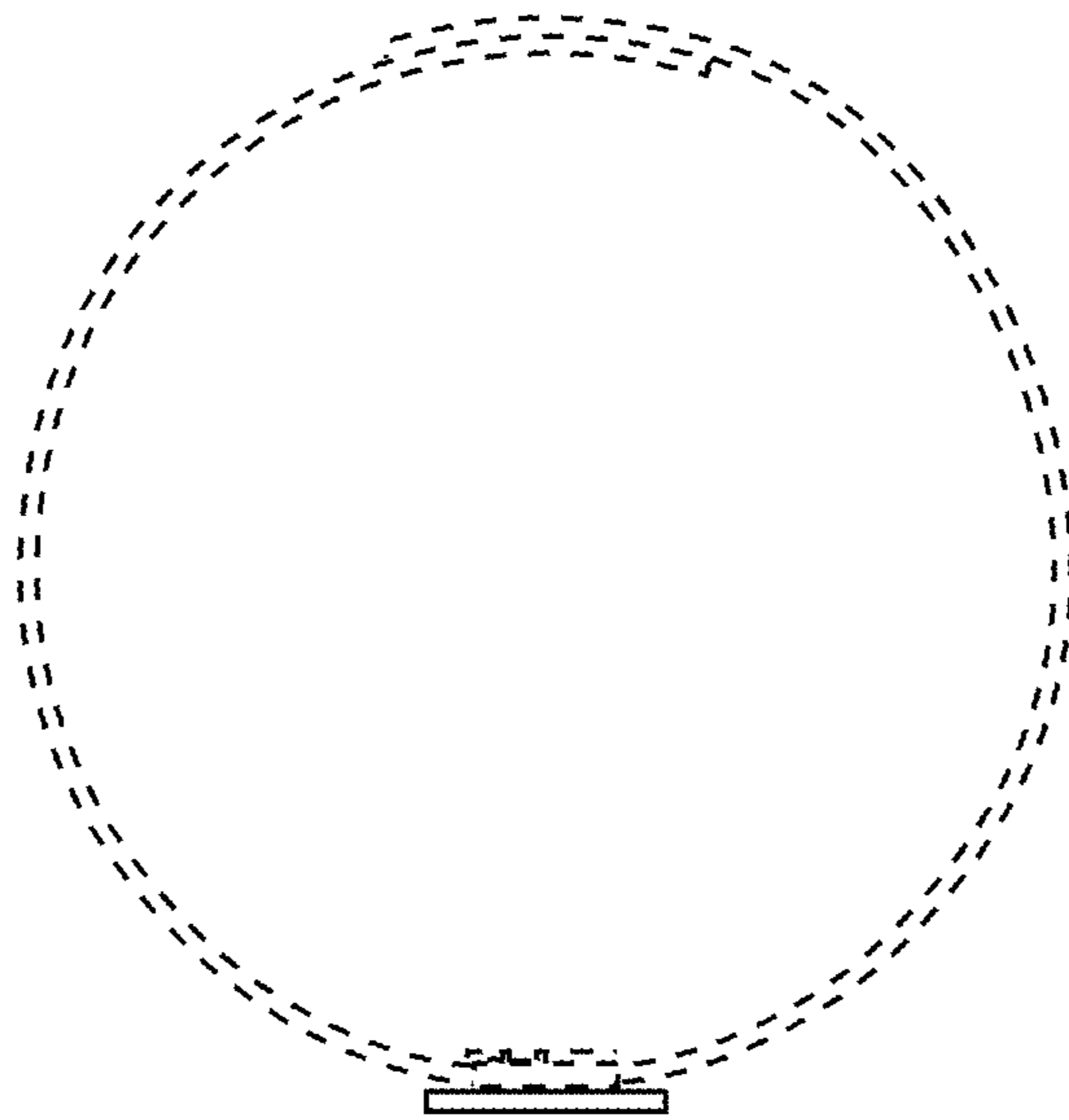




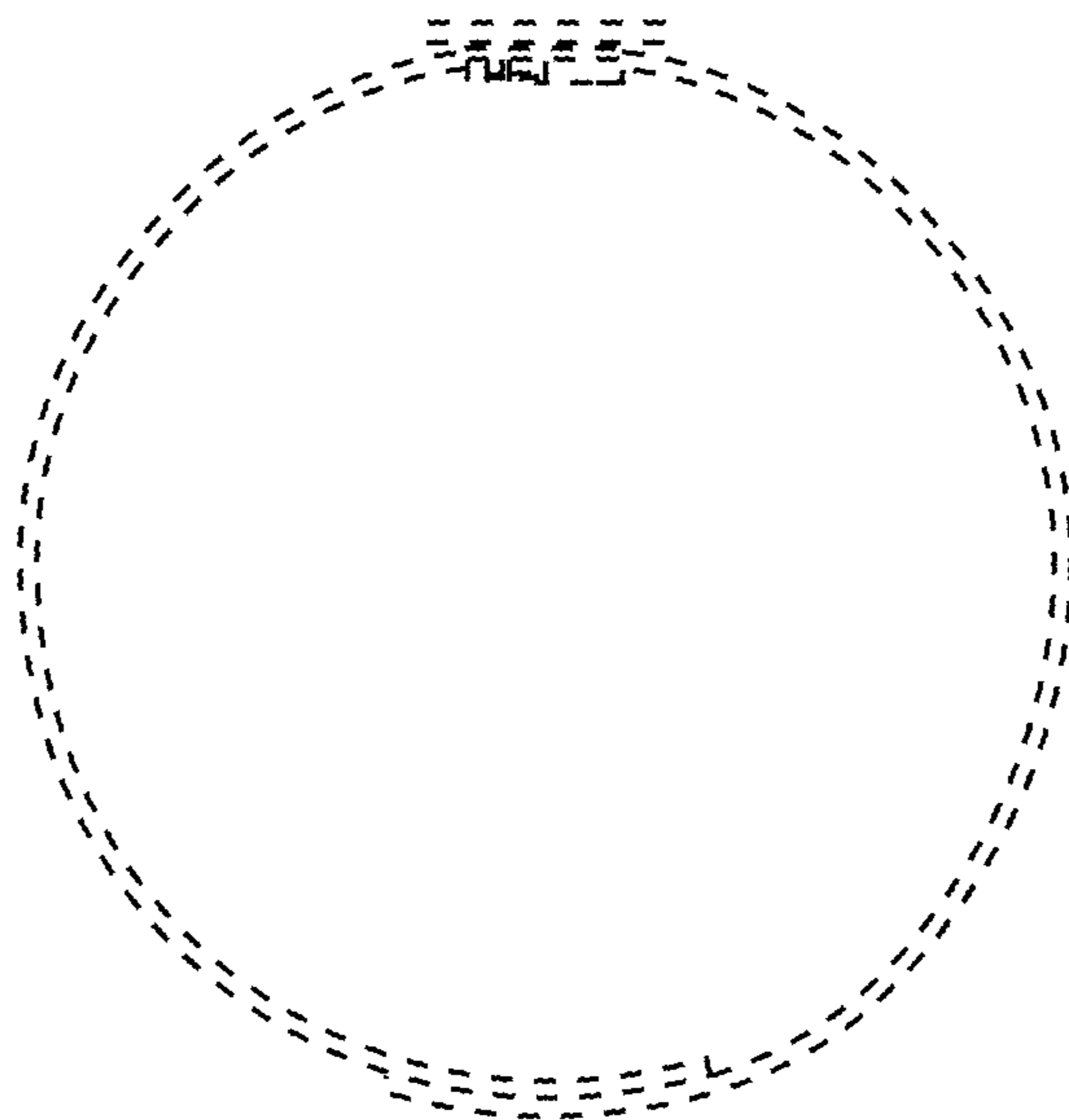
**FIG. 43**



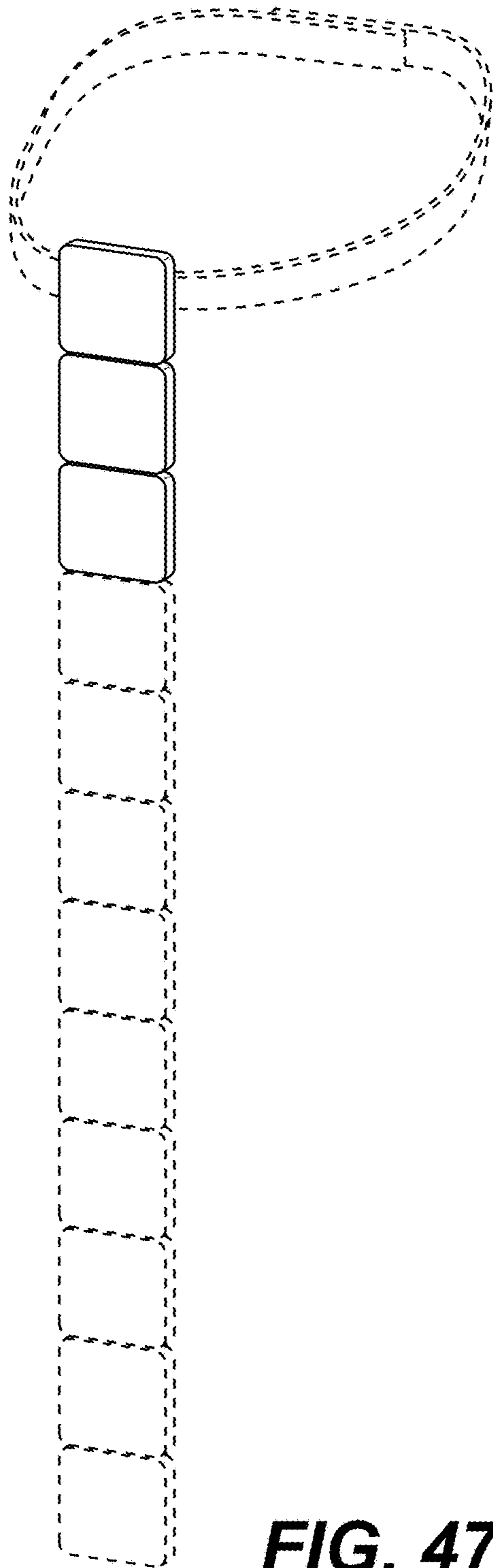
**FIG. 44**



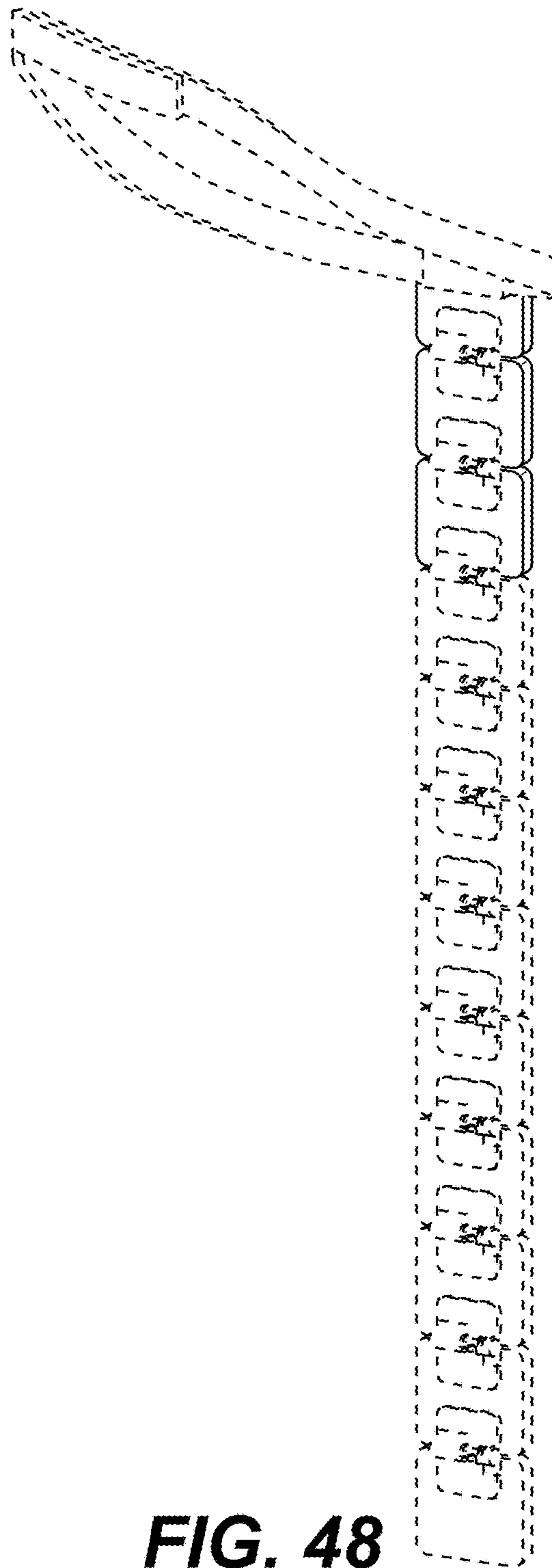
**FIG. 45**



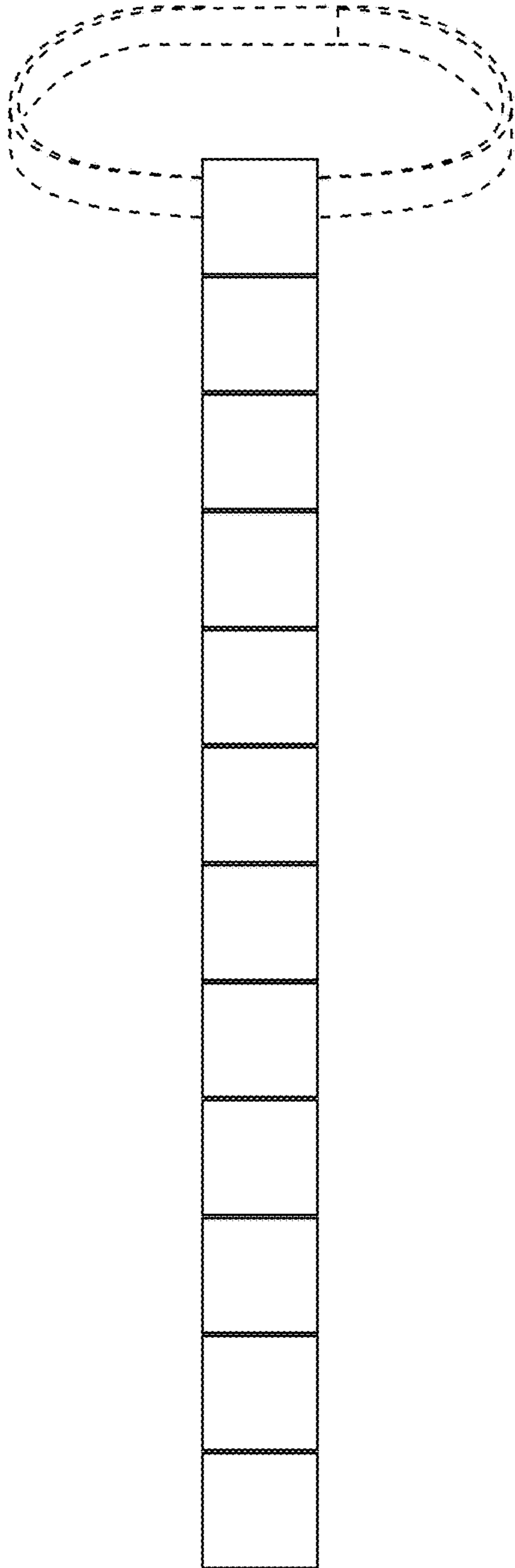
**FIG. 46**



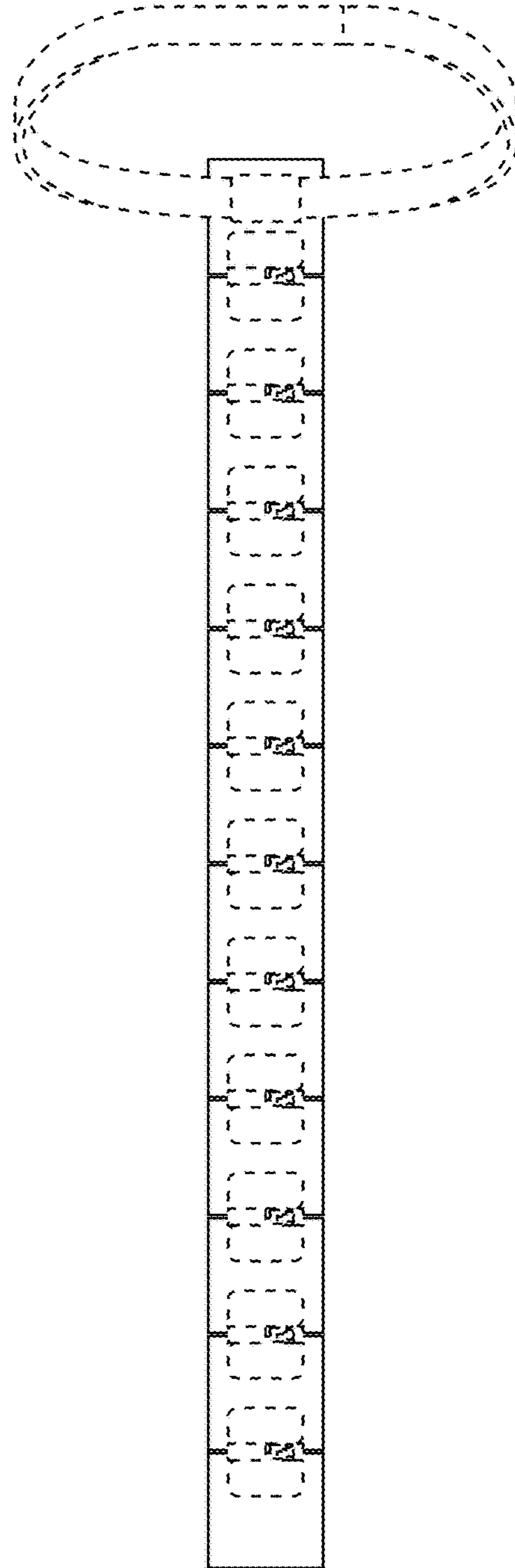
**FIG. 47**



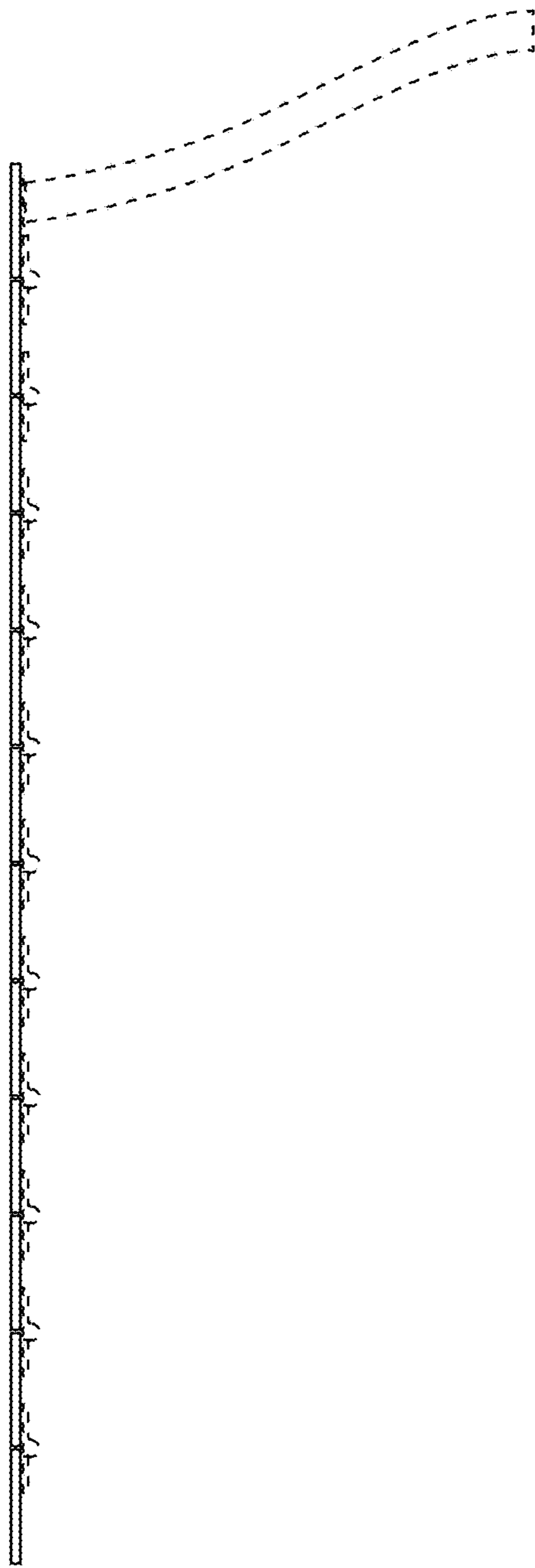
**FIG. 48**



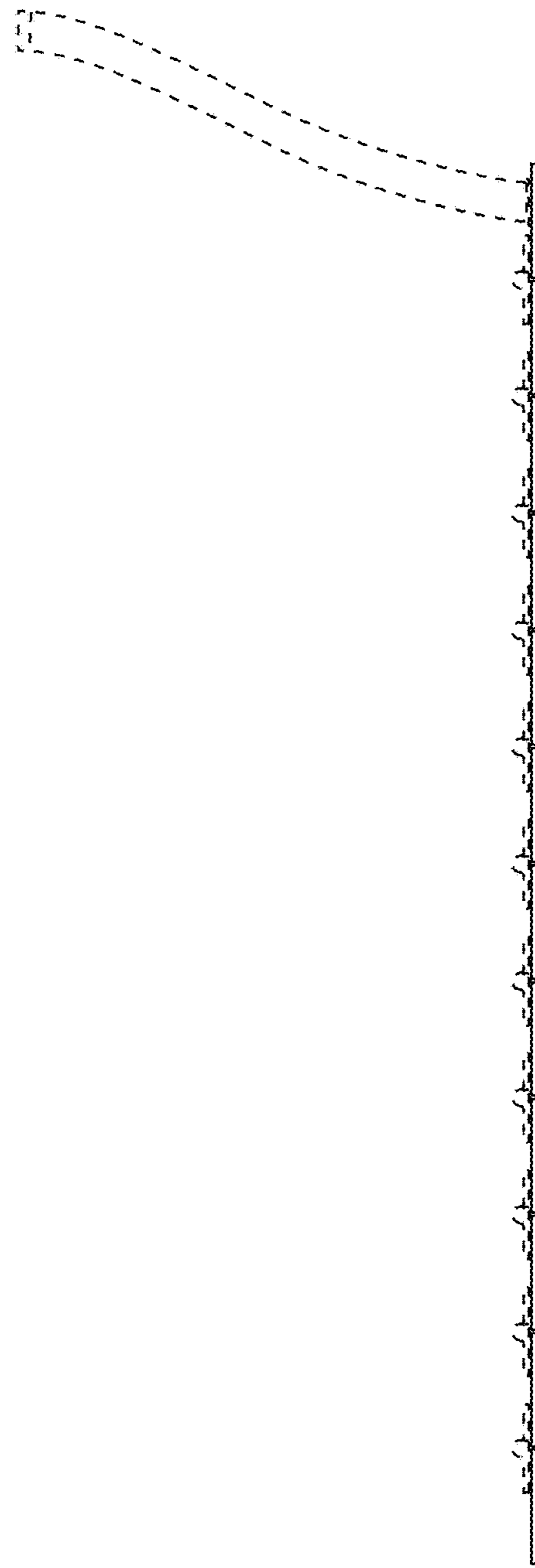
**FIG. 49**



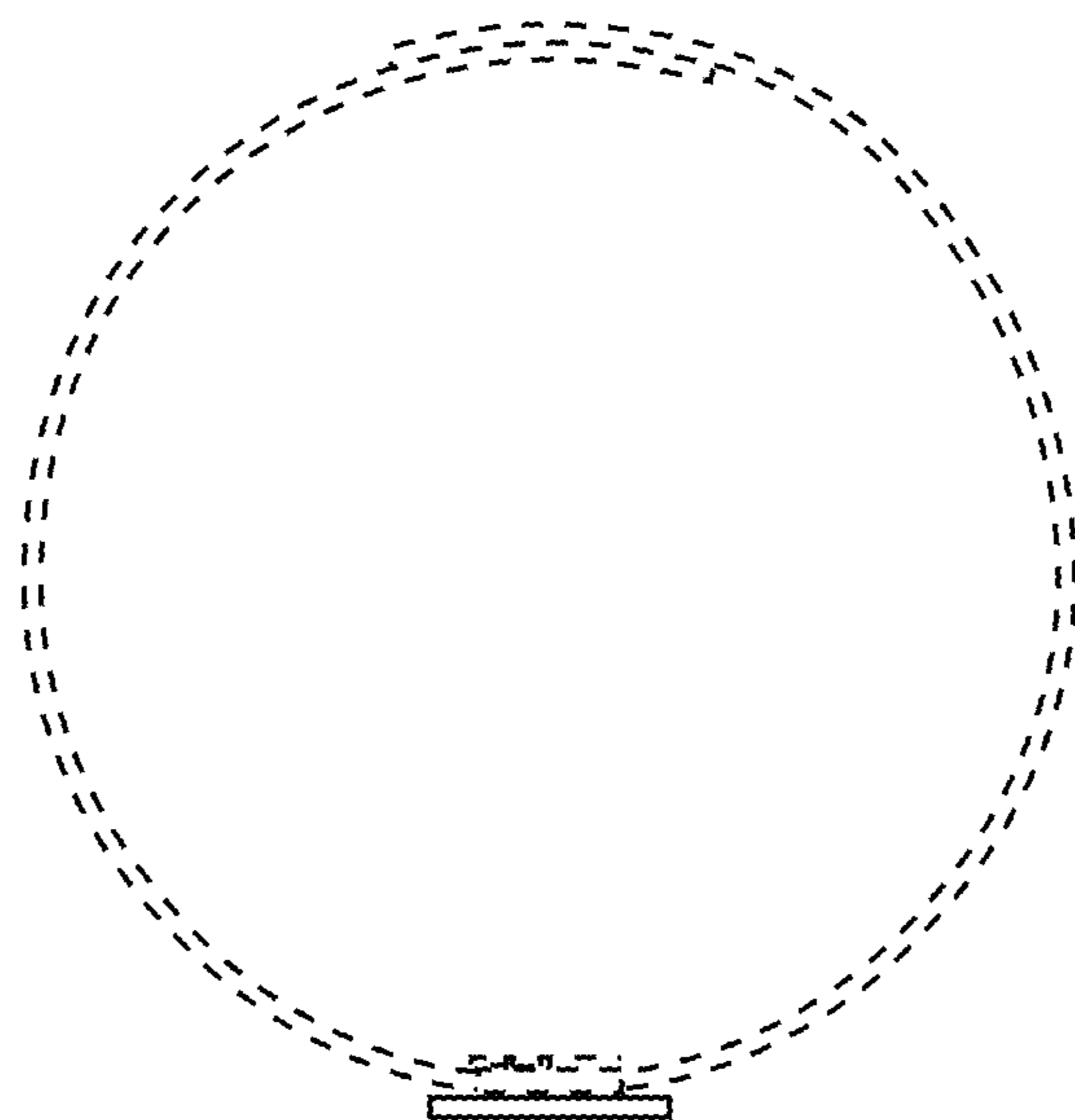
**FIG. 50**



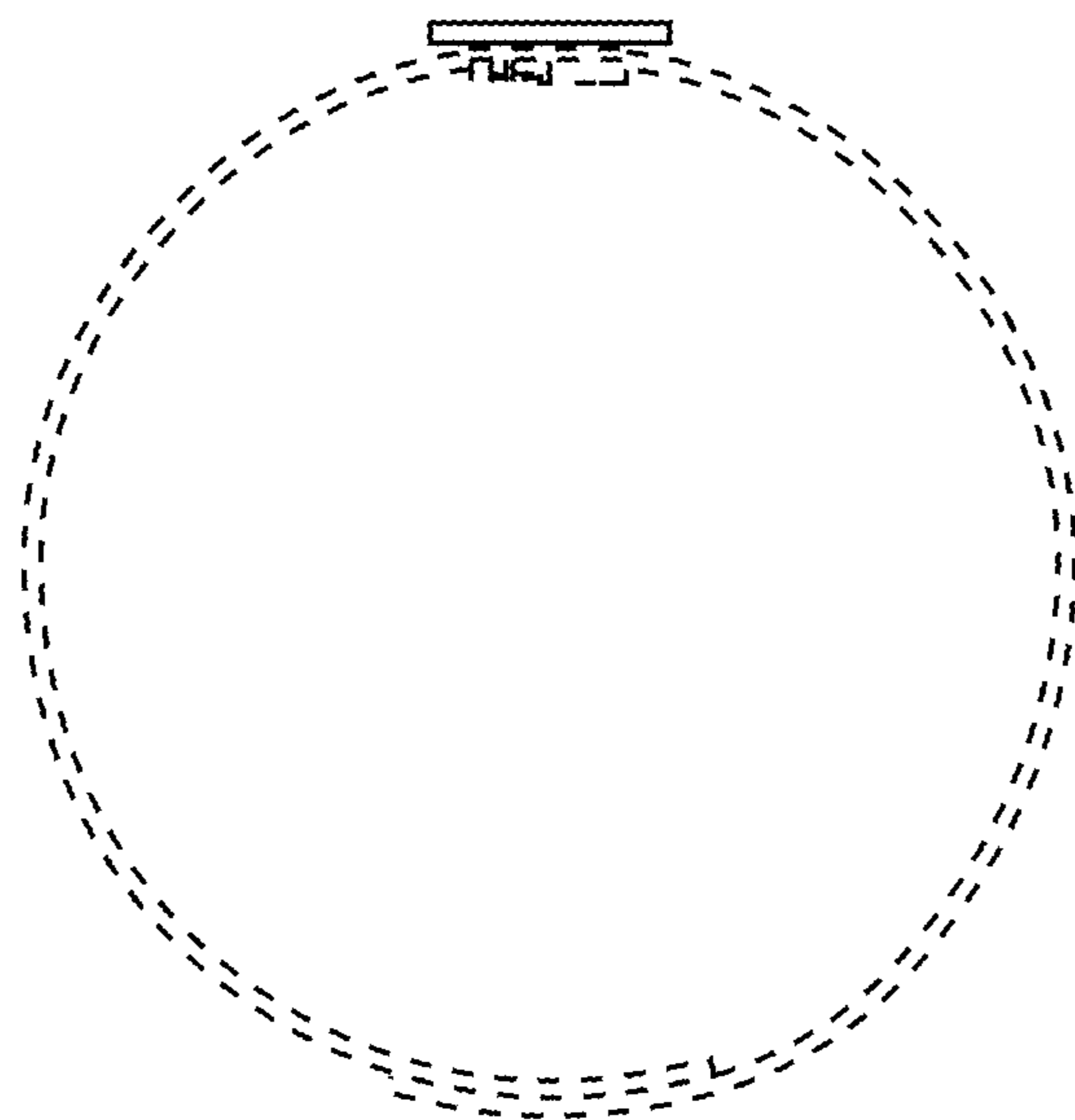
**FIG. 51**



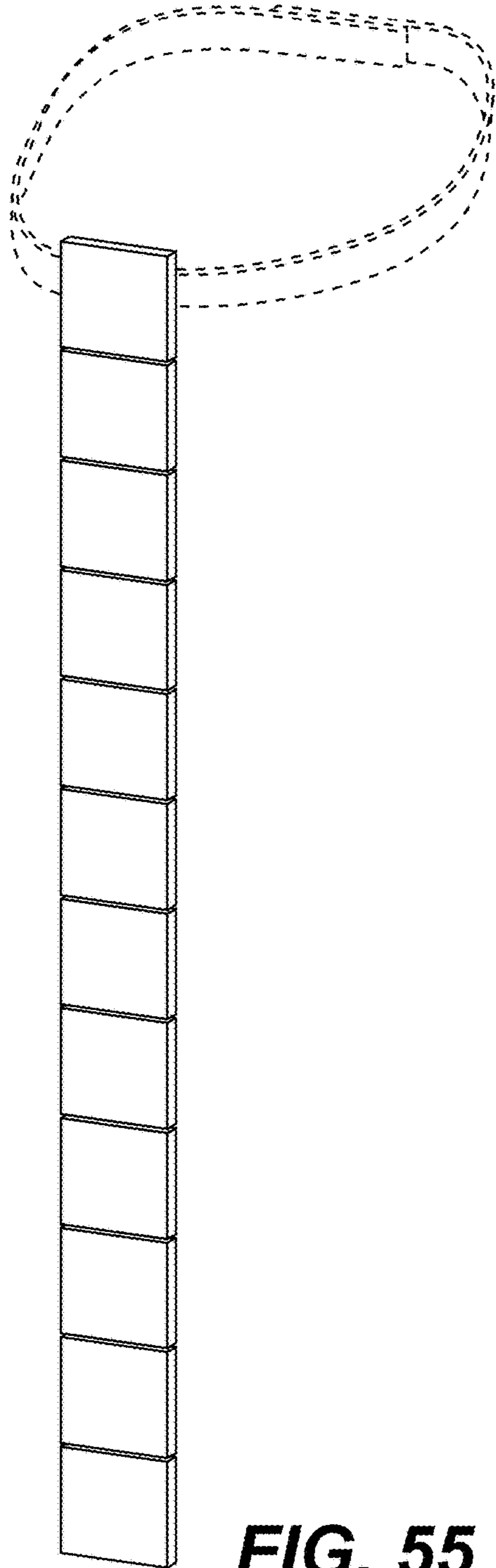
**FIG. 52**



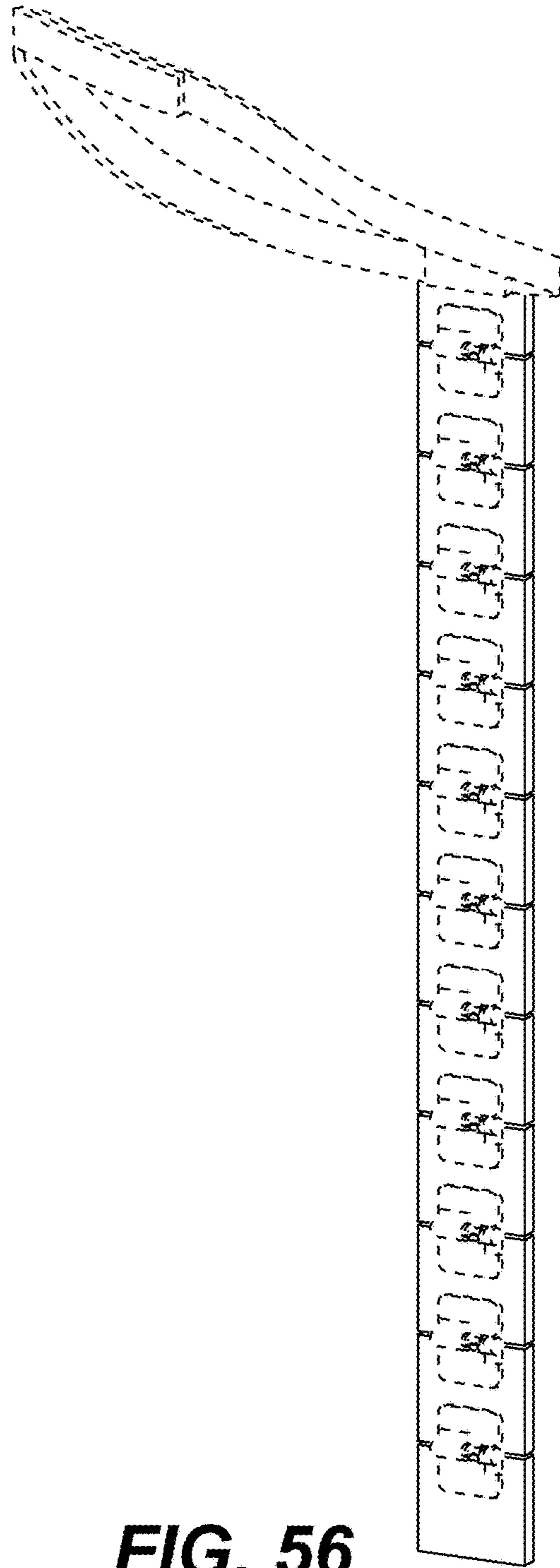
**FIG. 53**



**FIG. 54**

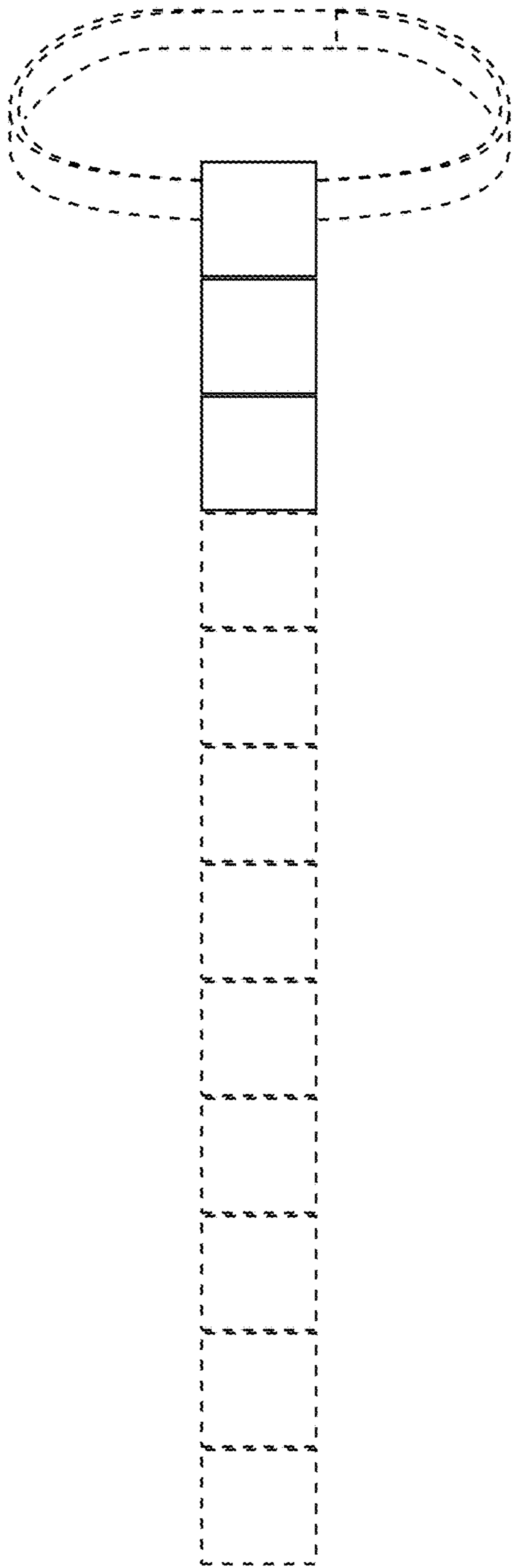


**FIG. 55**

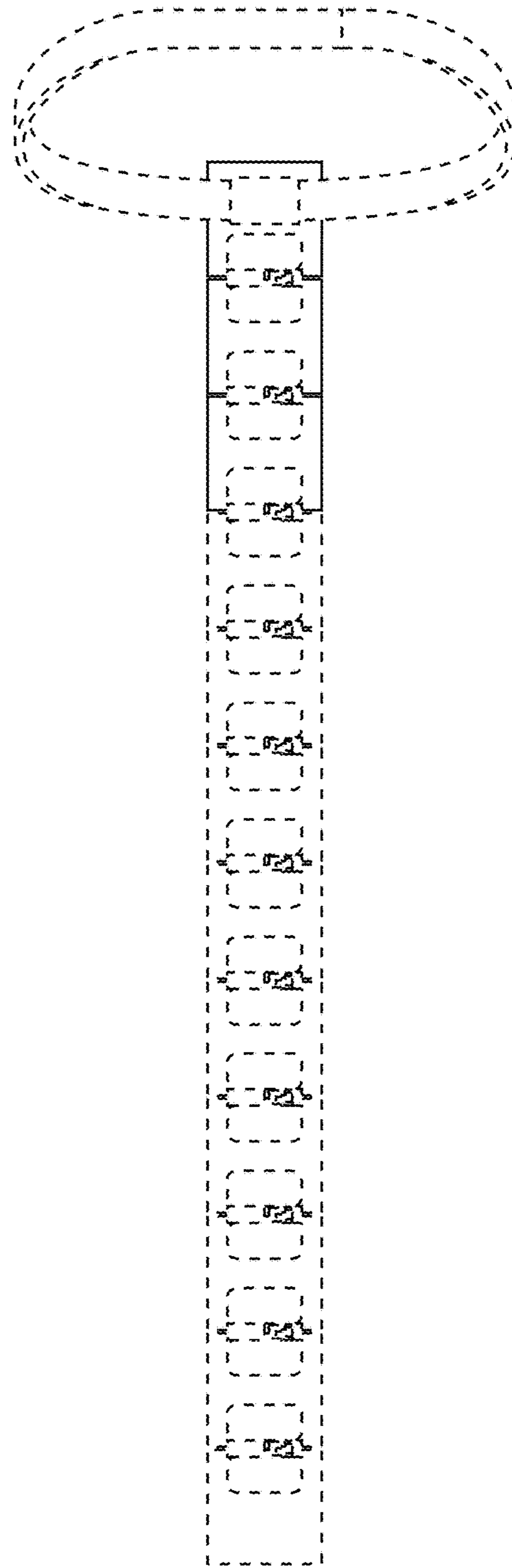


**FIG. 56**

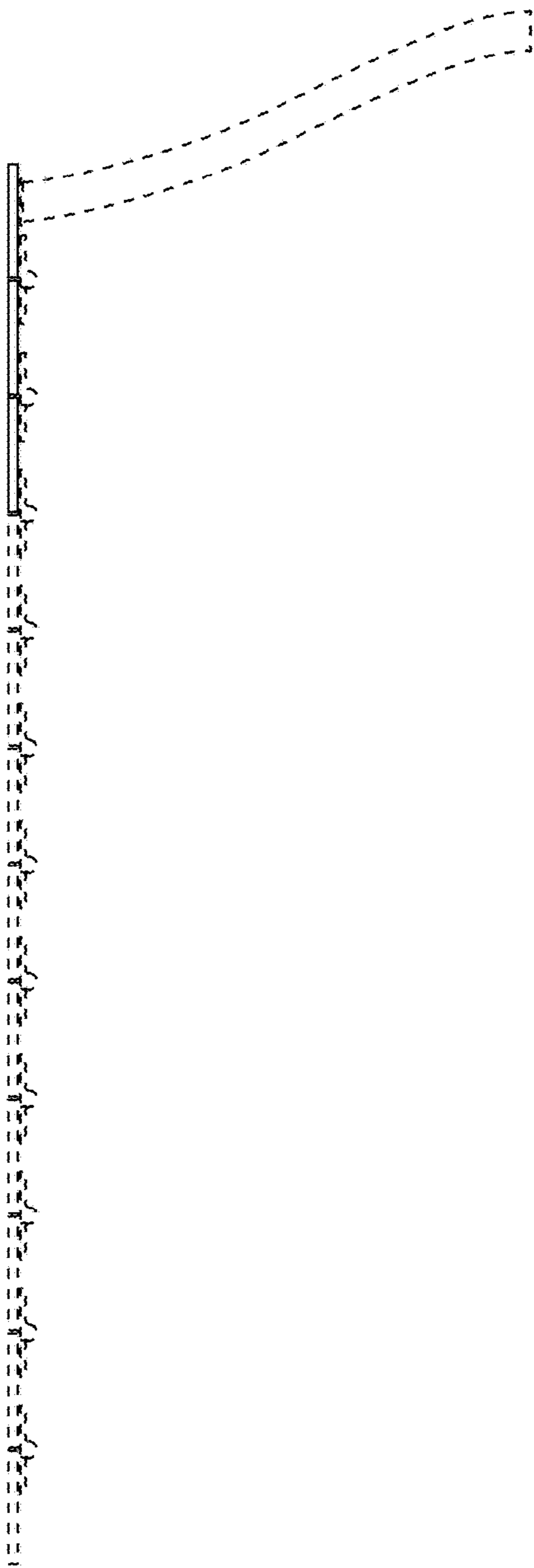




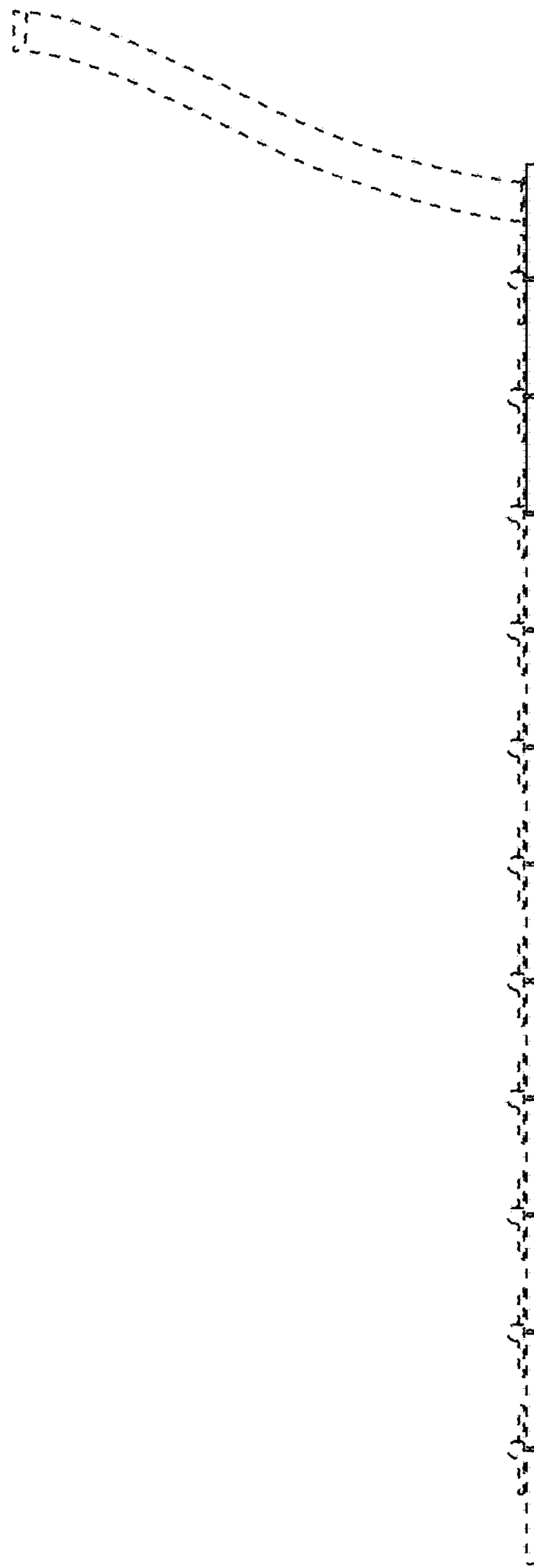
**FIG. 57**



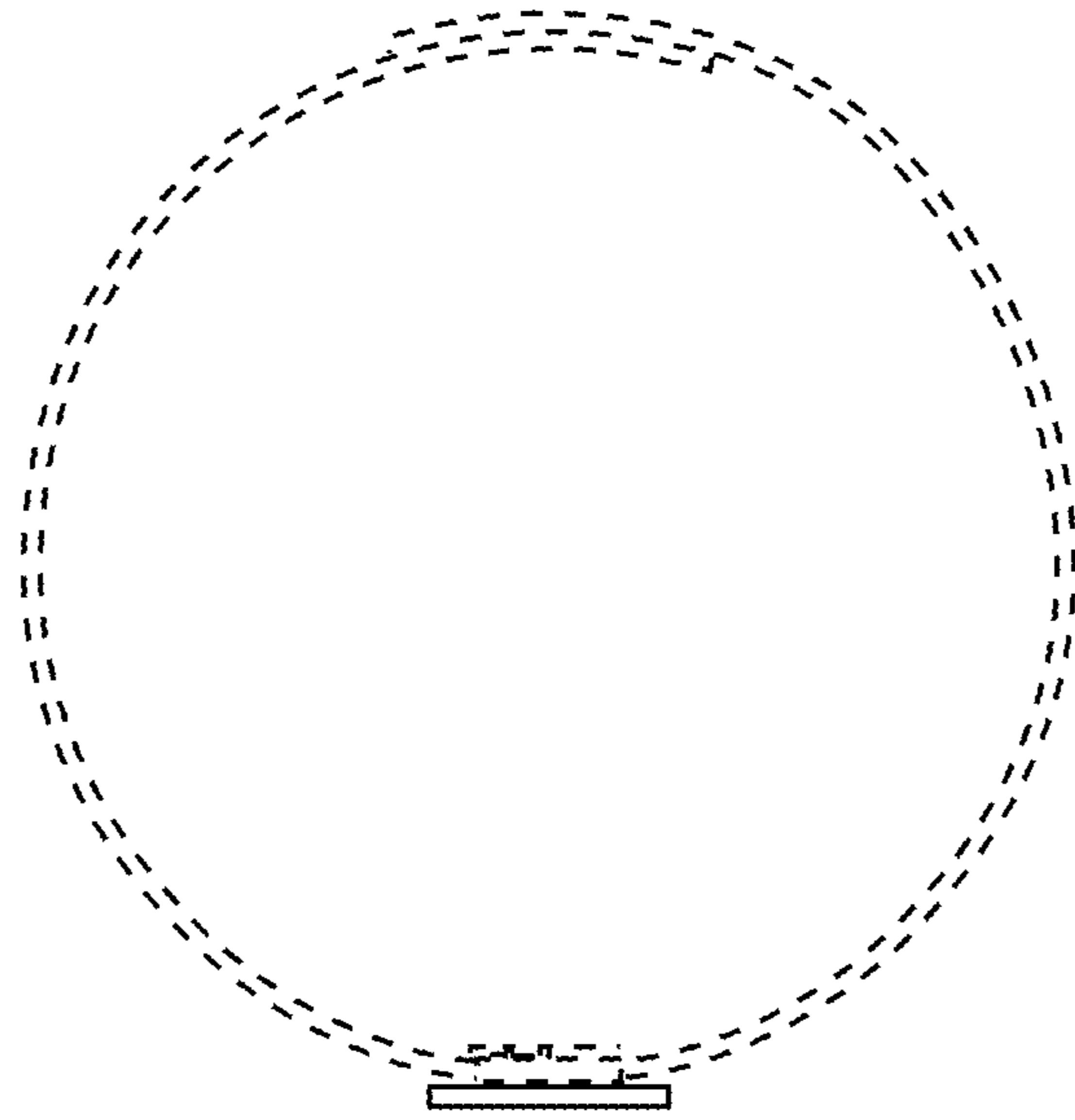
**FIG. 58**



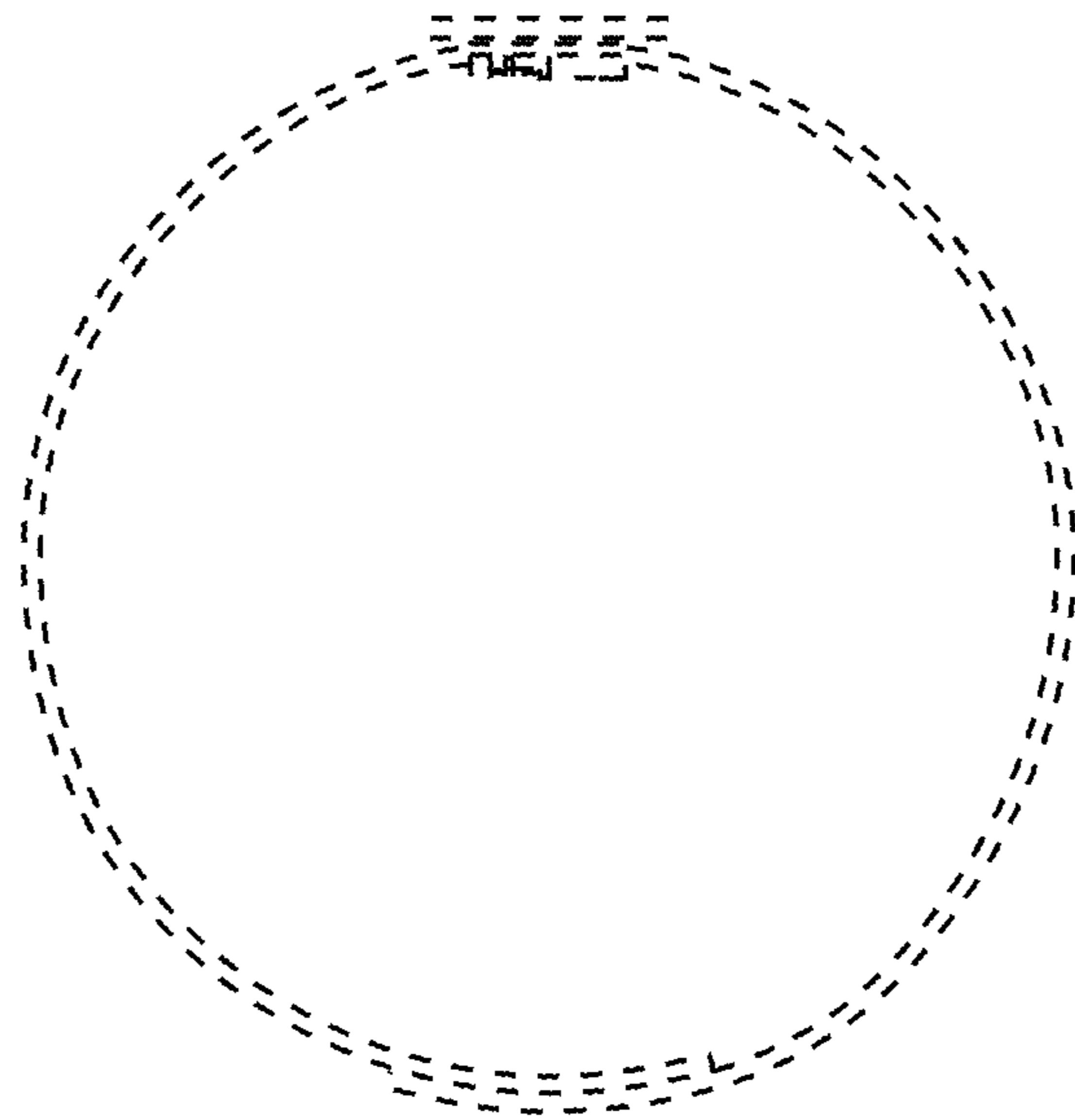
**FIG. 59**



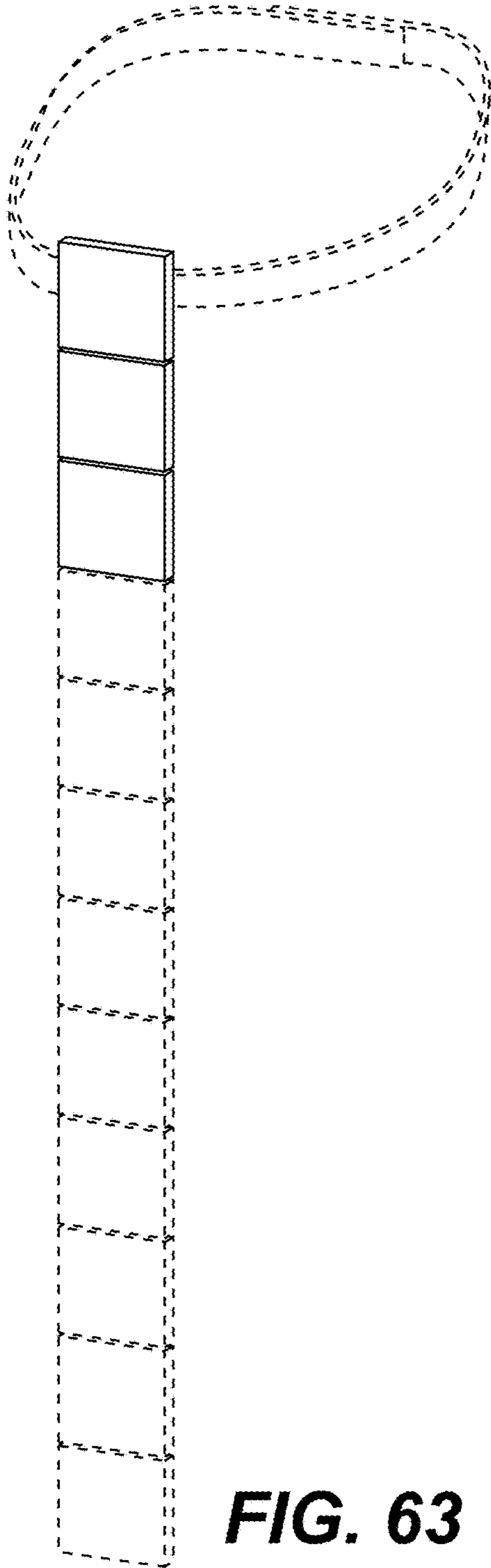
**FIG. 60**



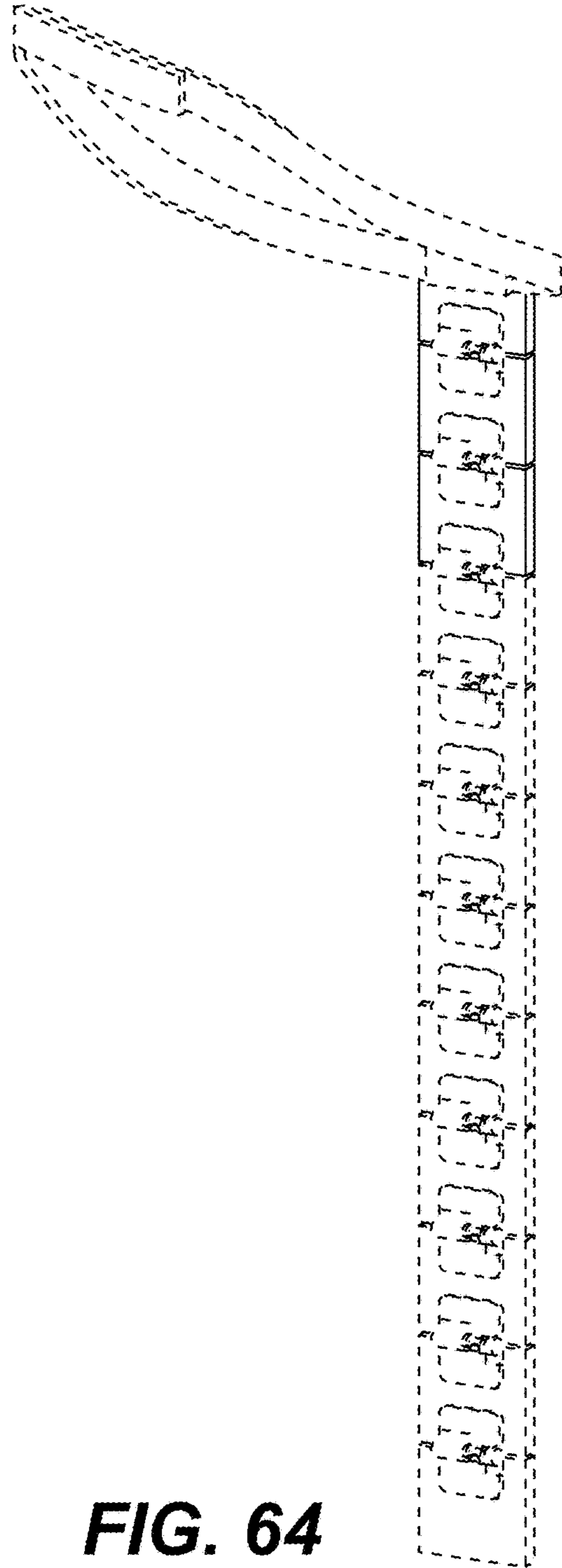
**FIG. 61**



**FIG. 62**



**FIG. 63**



**FIG. 64**