



US00D834947S

(12) **United States Design Patent**  
**Kim**

(10) **Patent No.:** **US D834,947 S**

(45) **Date of Patent:** **\*\* Dec. 4, 2018**

(54) **TEA BAG**

(71) Applicant: **TEAZEN, Inc.**, Haenam-gun,  
Jeollanam-do (KR)

(72) Inventor: **Jong Tae Kim**, Haenam-gun (KR)

(73) Assignee: **TEAZEN INC.**, Haenam-gun,  
Jeollanam-do (KR)

(\*\*) Term: **15 Years**

(21) Appl. No.: **29/599,898**

(22) Filed: **Apr. 7, 2017**

(51) **LOC (11) Cl.** ..... **09-05**

(52) **U.S. Cl.**  
USPC ..... **D9/702**

(58) **Field of Classification Search**  
USPC ..... D1/100–139, 199; 426/77–81, 83, 394,  
426/106; D9/702–714; D7/396.2, 400;  
99/279, 316; D23/366–368; D20/31;  
D32/59; D21/698; D24/118–119  
CPC ..... B65D 85/8043; B65D 85/808; B65D  
85/8046; B65D 85/812; B65D 29/00;  
B65D 29/02; B65D 31/00; B65D 33/00;  
A47G 19/16; B65B 1/00  
See application file for complete search history.

(56) **References Cited**

**U.S. PATENT DOCUMENTS**

D116,587 S \* 9/1939 Williams ..... D20/32  
D591,369 S \* 4/2009 Elder ..... D21/621

D643,078 S \* 8/2011 McDonald ..... D21/698  
D686,877 S \* 7/2013 Ortega ..... D7/396.2  
D699,917 S \* 2/2014 Shaw ..... D1/199  
D768,355 S \* 10/2016 Schwartz ..... D1/199  
D778,025 S \* 2/2017 Kim ..... D1/108

\* cited by examiner

*Primary Examiner* — Abraham Bahta

(74) *Attorney, Agent, or Firm* — Juan Carlos A. Marquez;  
Marquez IP Law Office, PLLC

(57) **CLAIM**

The ornamental design for a tea bag, as shown and described.

**DESCRIPTION**

FIG. 1 is a perspective view of a tea bag showing my new design;  
FIG. 2 is a front view thereof;  
FIG. 3 is a rear view thereof;  
FIG. 4 is a left side view thereof;  
FIG. 5 is a right side view thereof;  
FIG. 6 is a top view thereof;  
FIG. 7 is a bottom plan view thereof; and,  
FIG. 8 is a perspective view thereof shown in environments of use.  
The broken line showing of portions of the tea bag is included for the purpose of illustrating environmental structure forms no part of the claimed design.

**1 Claim, 6 Drawing Sheets**

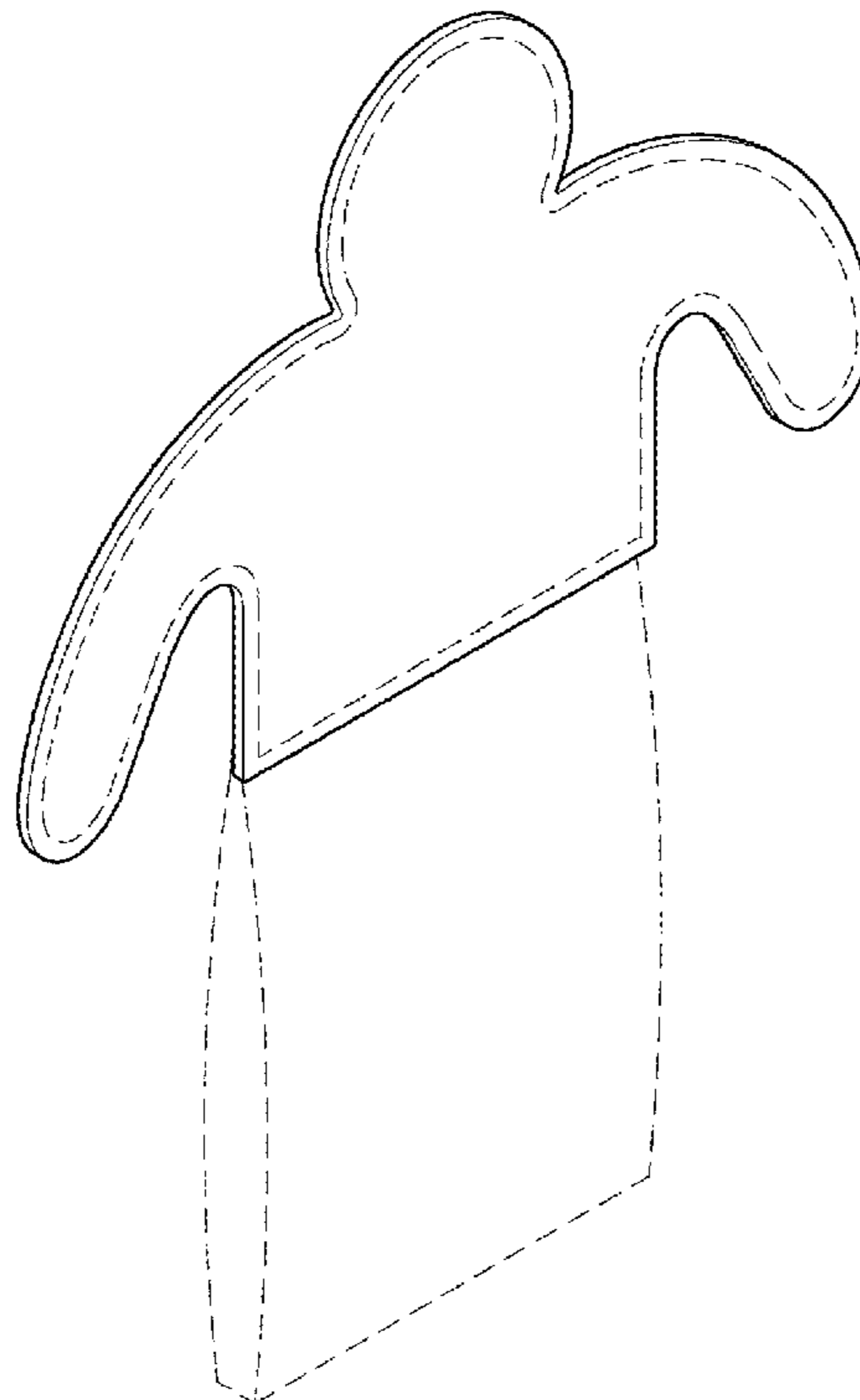

FIG. 1

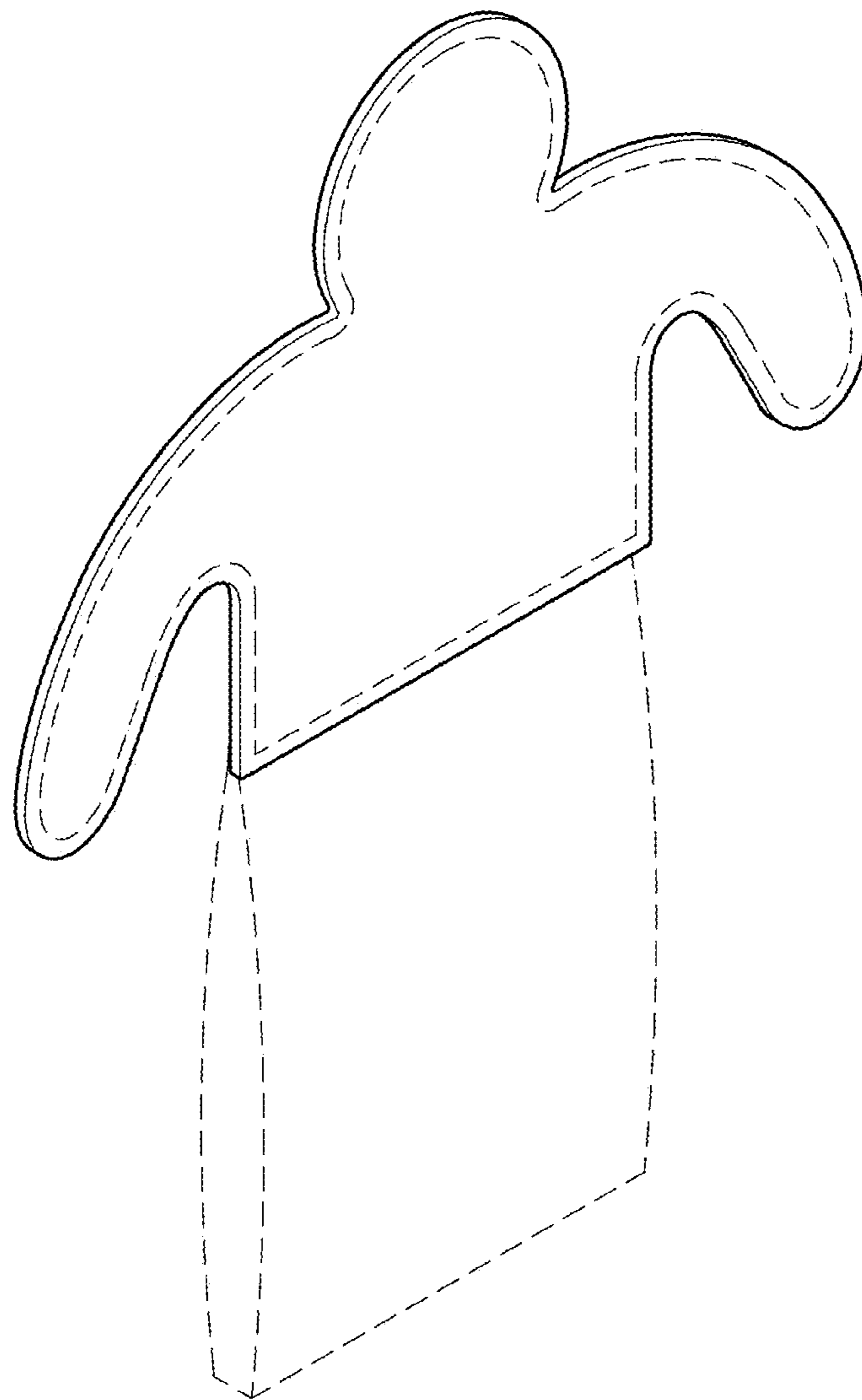

FIG. 2

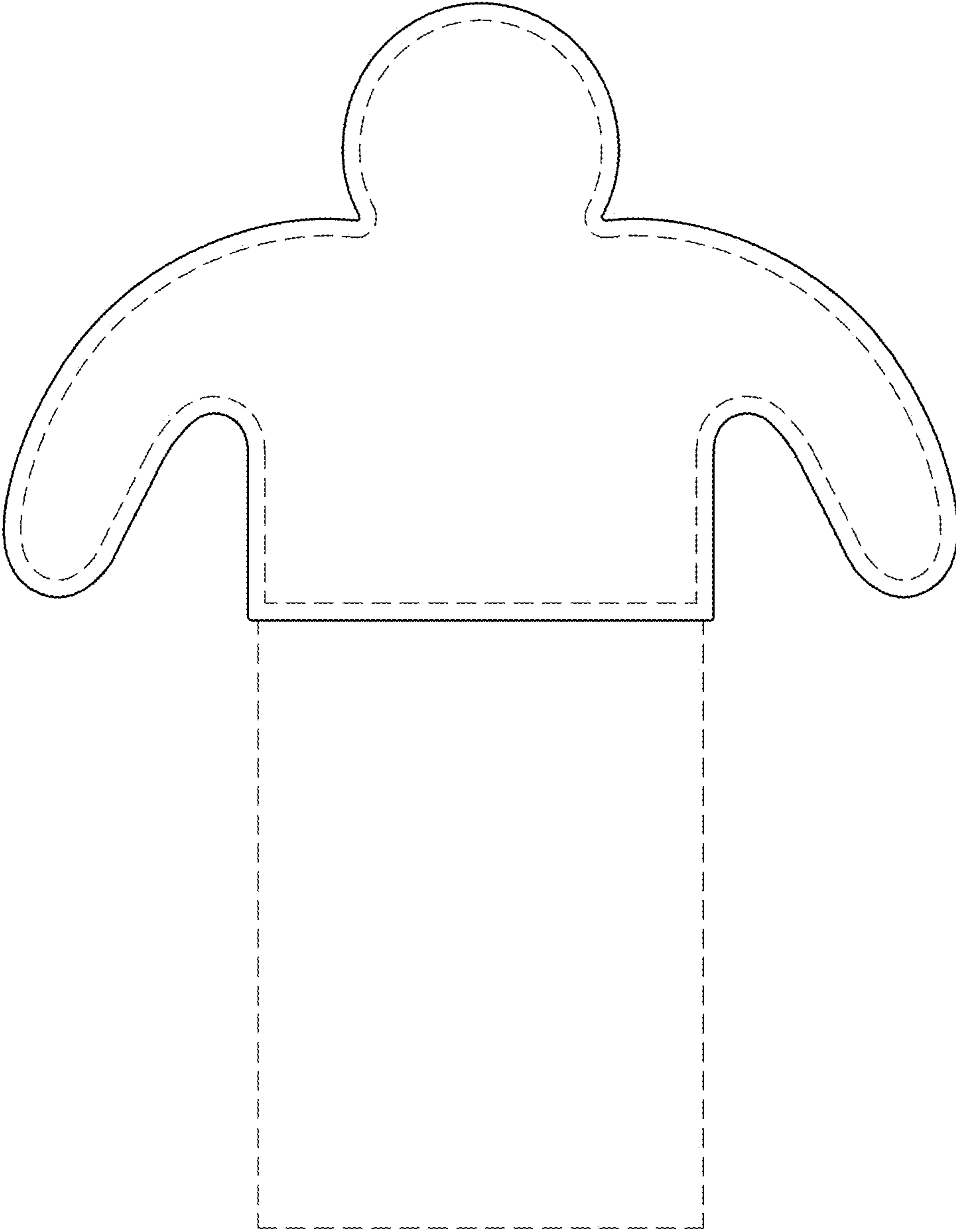

FIG. 3

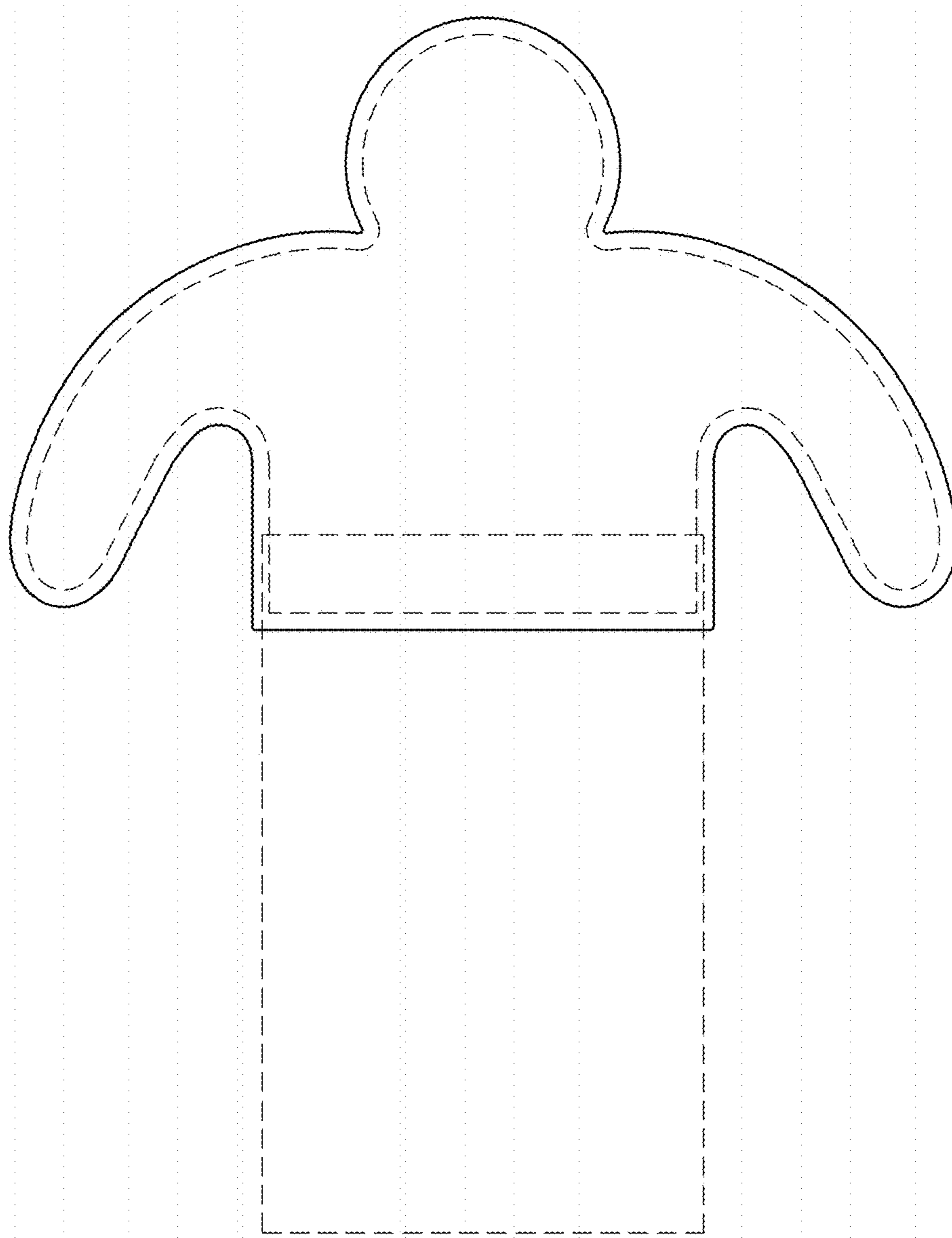

FIG. 4

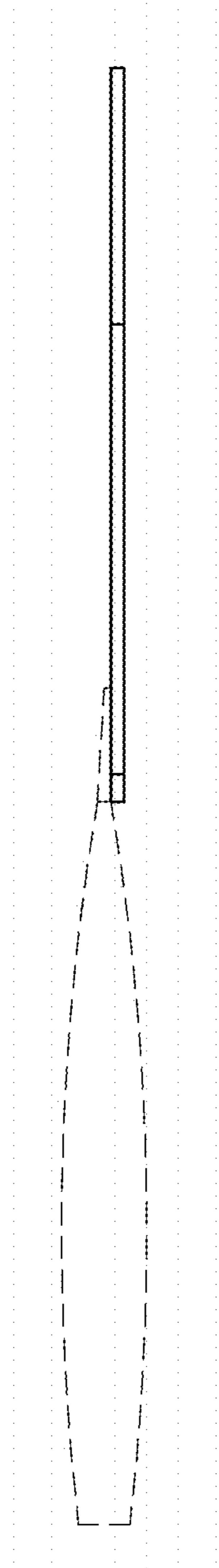

FIG. 5

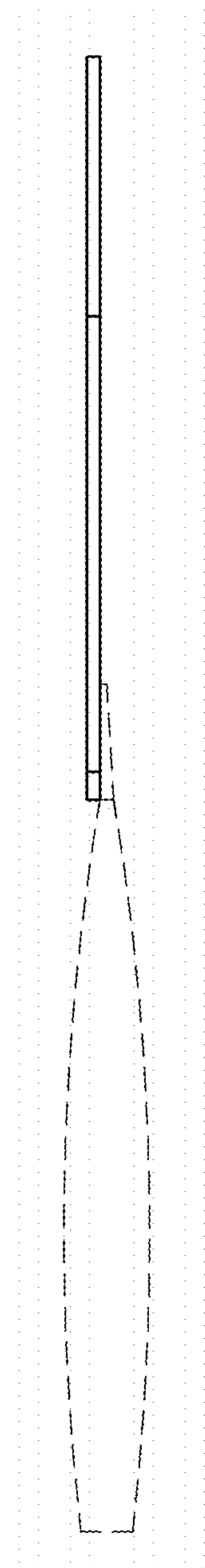

FIG. 6

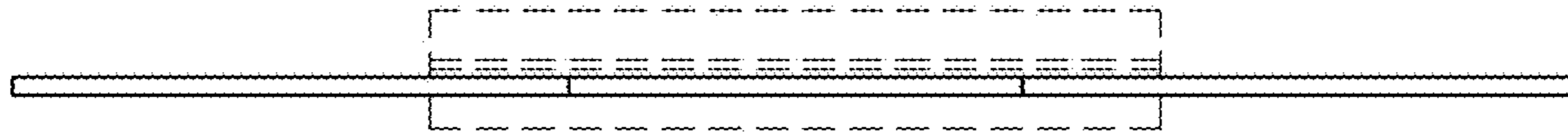

FIG. 7

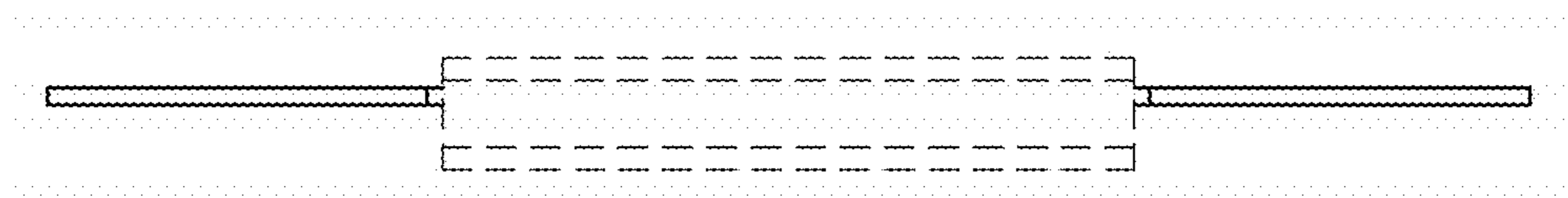

FIG. 8

