



US00D834888S

(12) **United States Design Patent** (10) **Patent No.:** **US D834,888 S**
King (45) **Date of Patent:** **** Dec. 4, 2018**

(54) **SMOKER BOX**
(71) Applicant: **Patrick King**, Rosemount, MN (US)
(72) Inventor: **Patrick King**, Rosemount, MN (US)
(**) Term: **15 Years**
(21) Appl. No.: **29/601,669**
(22) Filed: **Apr. 25, 2017**
(51) **LOC (11) Cl.** **31-00**
(52) **U.S. Cl.**
USPC **D7/409**
(58) **Field of Classification Search**
USPC D27/172, 183, 186, 187, 189, 190, 191;
D3/302, 273; D9/500, 503, 504,
D9/423-428, 414, 418, 430-433;
206/268, 265, 269, 242, 252; D7/409,
D7/402-408; 99/352, 482
CPC B65D 85/00; B65D 85/10; B65D 85/08;
B65D 85/12; B65D 85/14; A24F 15/18;
A24D 1/12; F23Q 2/36; F23Q 2/38;
A23B 4/502; A23B 4/044
See application file for complete search history.

7,698,996 B1 * 4/2010 Savchuk A23B 4/044
99/470
D626,688 S * 11/2010 Gibson D27/183
D668,949 S * 10/2012 Hipperson D9/423
D699,103 S * 2/2014 Rathbone D9/418
8,997,639 B2 * 4/2015 Adams A23B 4/044
99/401
D730,886 S * 6/2015 Tseng D14/251
D756,562 S * 5/2016 Ghiotti D27/186
D756,563 S * 5/2016 Joyce, III D27/189
D798,500 S * 9/2017 Joyce, III D27/189
D806,536 S * 1/2018 Kato D9/432
D808,258 S * 1/2018 Lee D9/431
2002/0166460 A1 11/2002 O'Shea
2009/0199842 A1 8/2009 Foster

* cited by examiner

Primary Examiner — Susan Bennett Hattan
Assistant Examiner — Rebecca Tsehaye
(74) *Attorney, Agent, or Firm* — Global Intellectual
Property Agency, LLC; Daniel Boudwin

(57) **CLAIM**

The ornamental design for a smoker box, as shown and described.

DESCRIPTION

FIG. 1 shows a perspective view of the smoker box.
FIG. 2 shows a right side elevation view thereof.
FIG. 3 shows a left side elevation view thereof.
FIG. 4 shows a bottom elevation view thereof.
FIG. 5 shows a top elevation view thereof.
FIG. 6 shows a front elevation view thereof; and,
FIG. 7 shows a rear elevation view thereof.

1 Claim, 6 Drawing Sheets

(56) **References Cited**
U.S. PATENT DOCUMENTS

D314,914 S * 2/1991 Callinan D27/186
5,564,330 A 10/1996 Nowicke
D409,329 S * 5/1999 Bucher D27/186
D410,818 S * 6/1999 Best D7/332
5,909,729 A 6/1999 Nowicke
6,016,797 A 1/2000 Nowicke

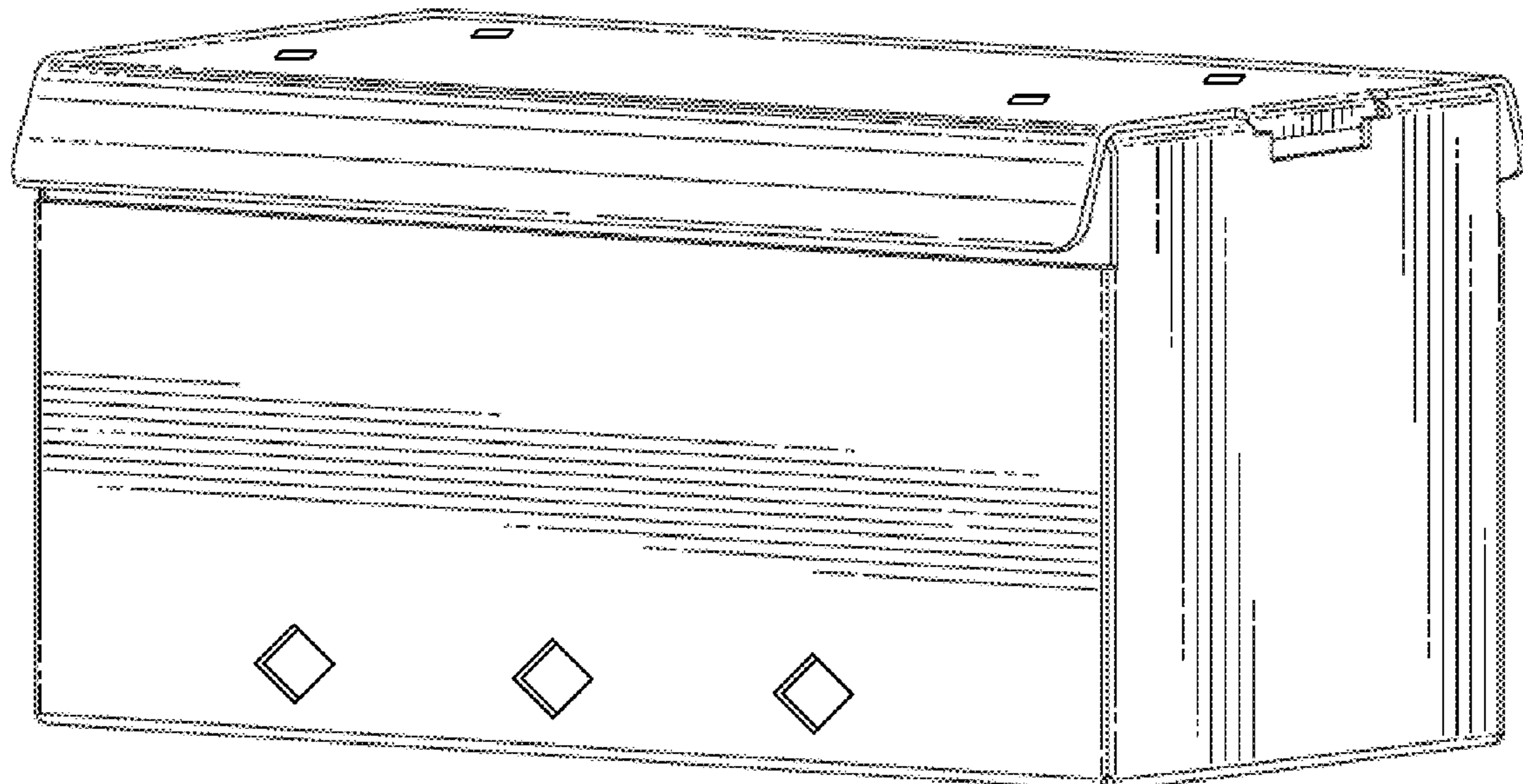

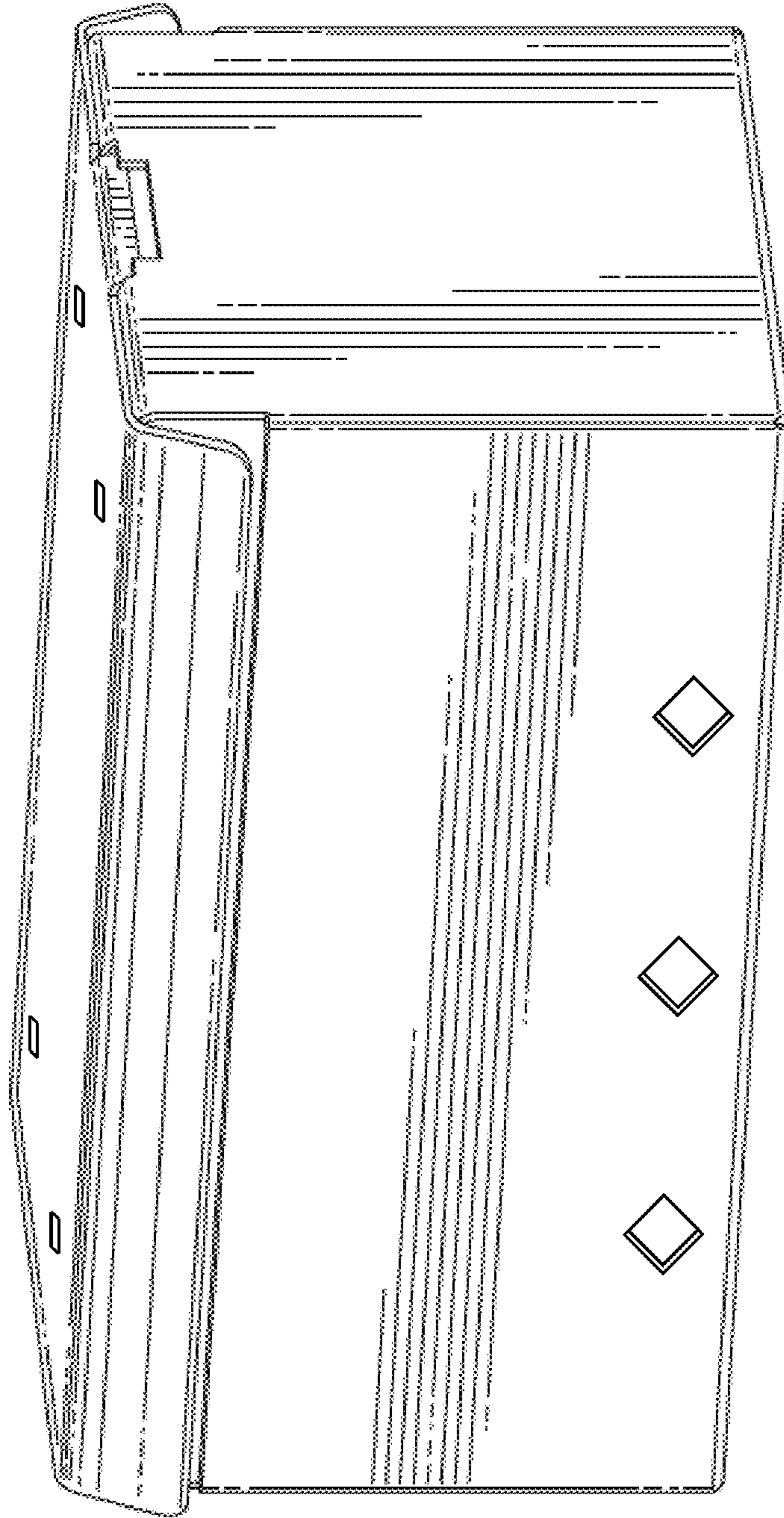

FIG. 1

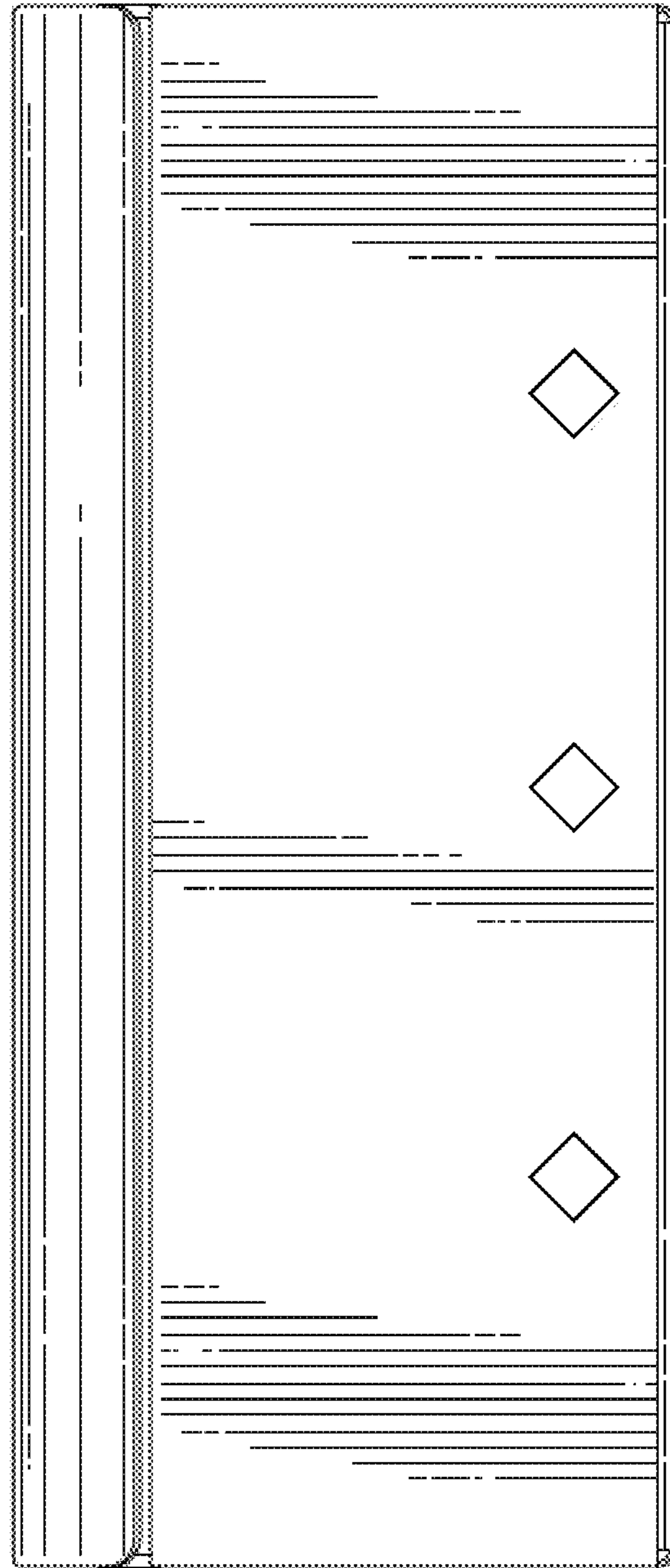

FIG. 2

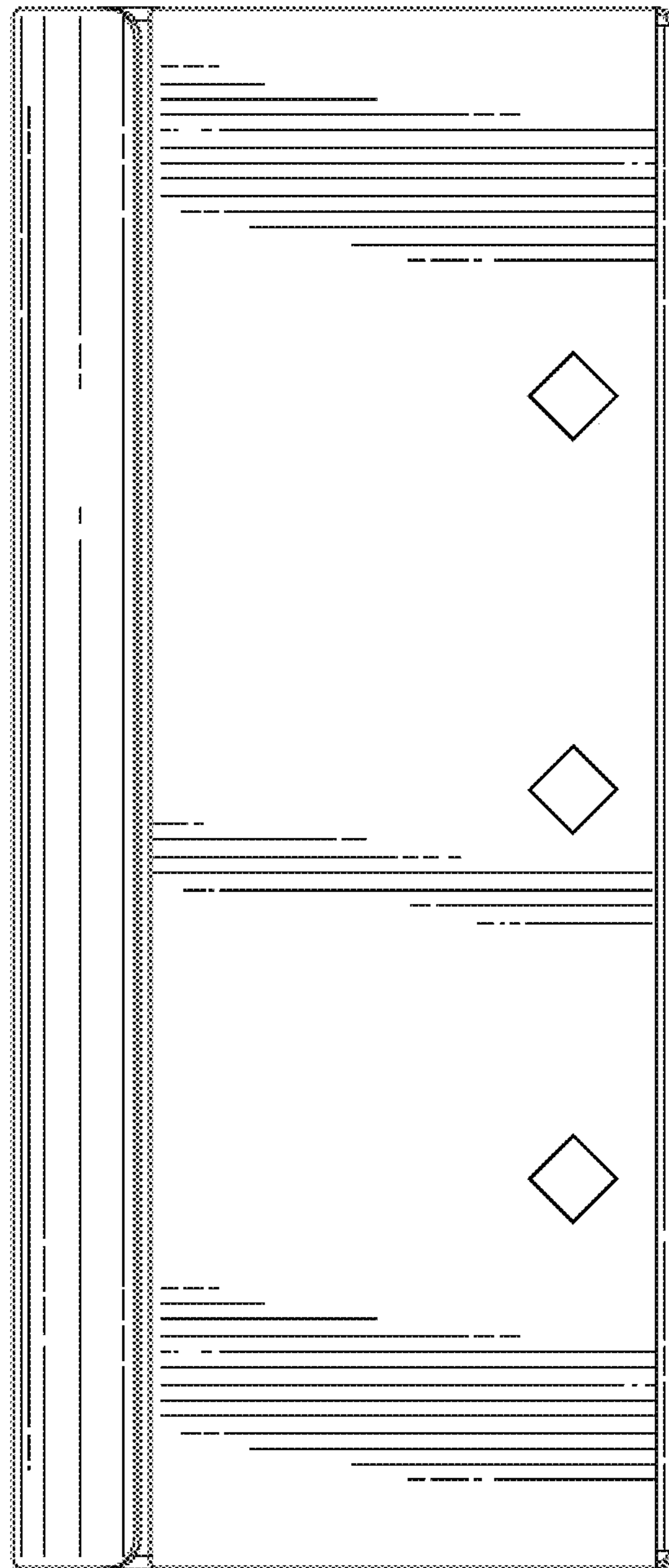

FIG. 3

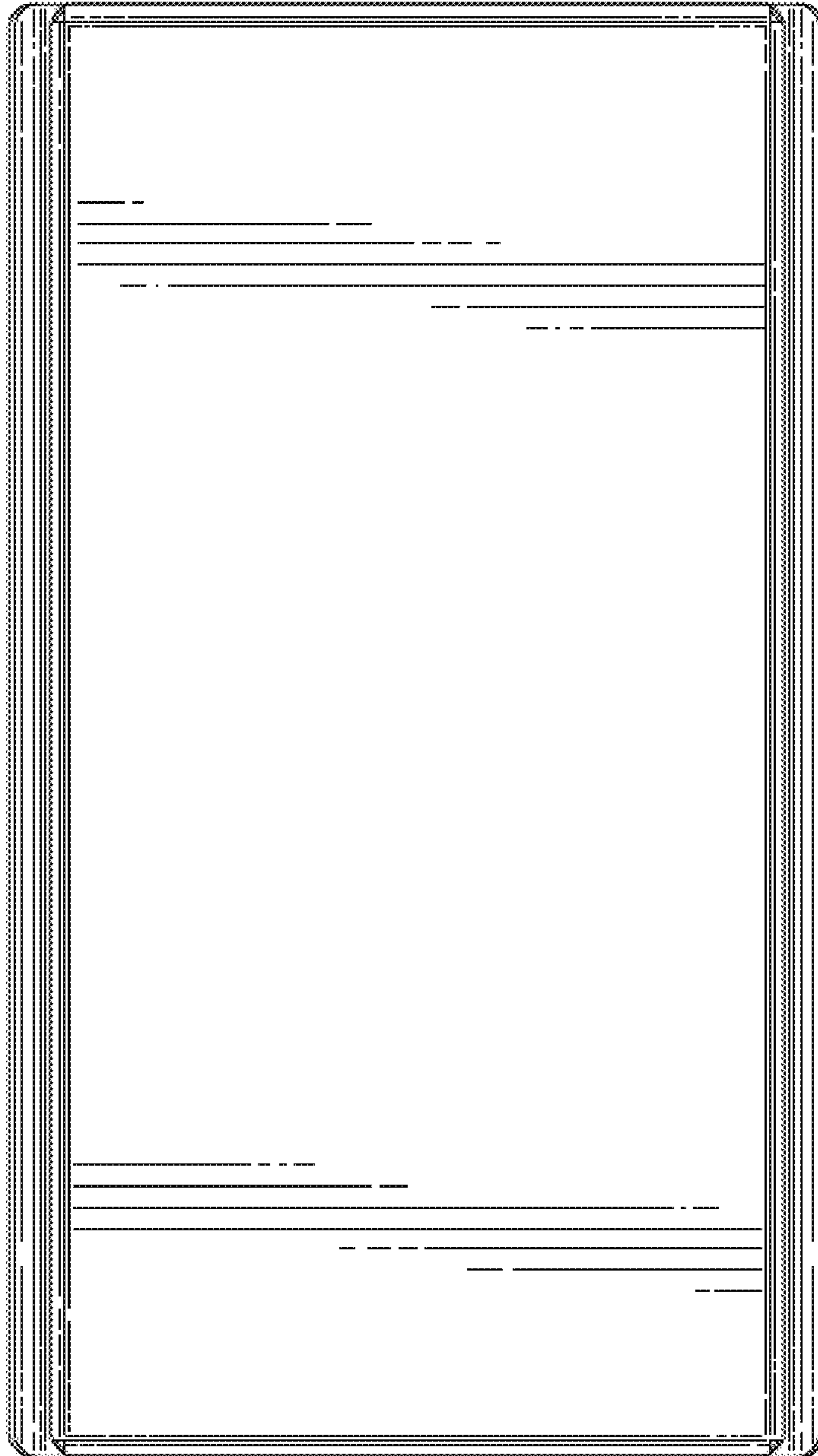

FIG. 4

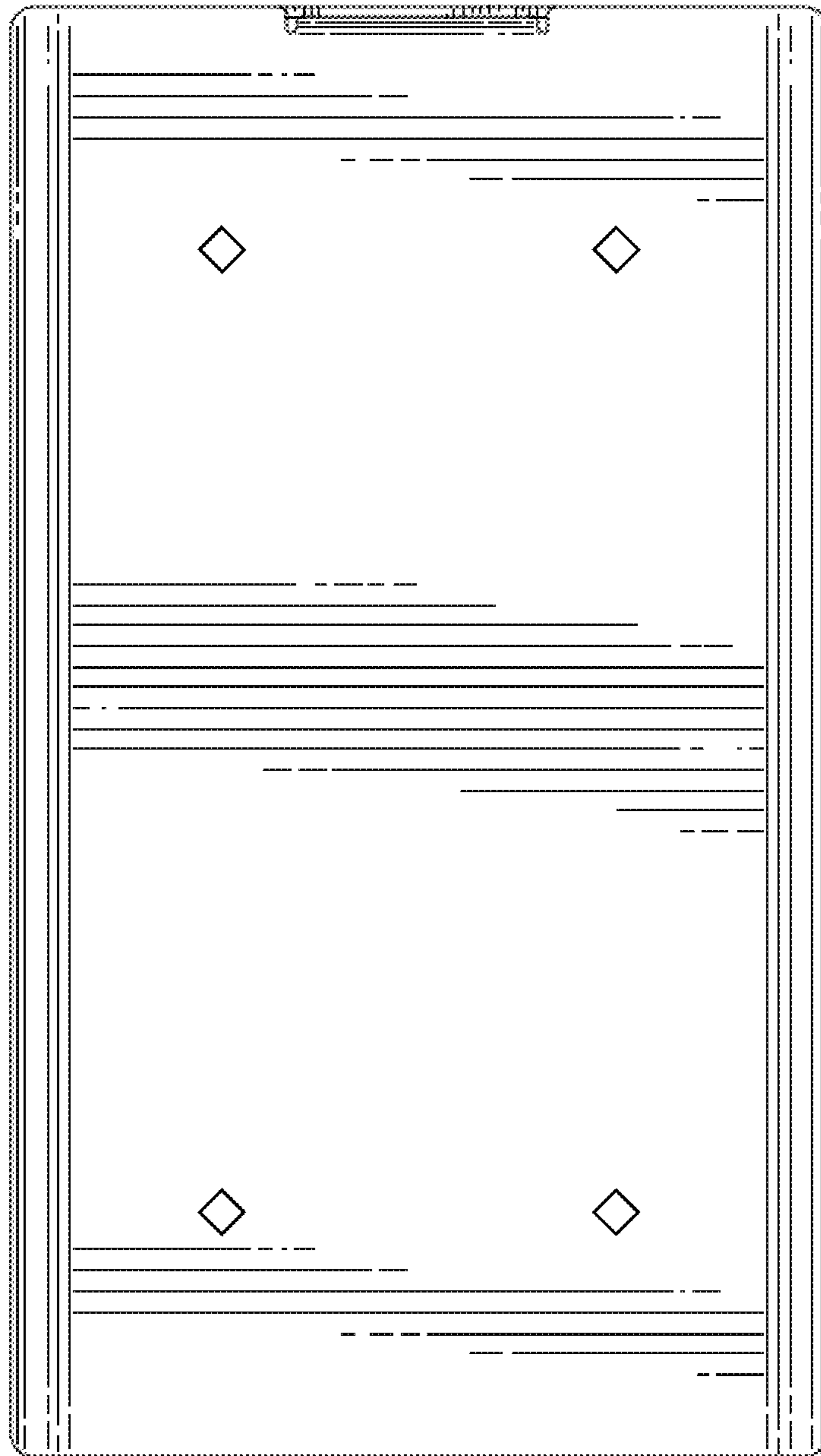

FIG. 5

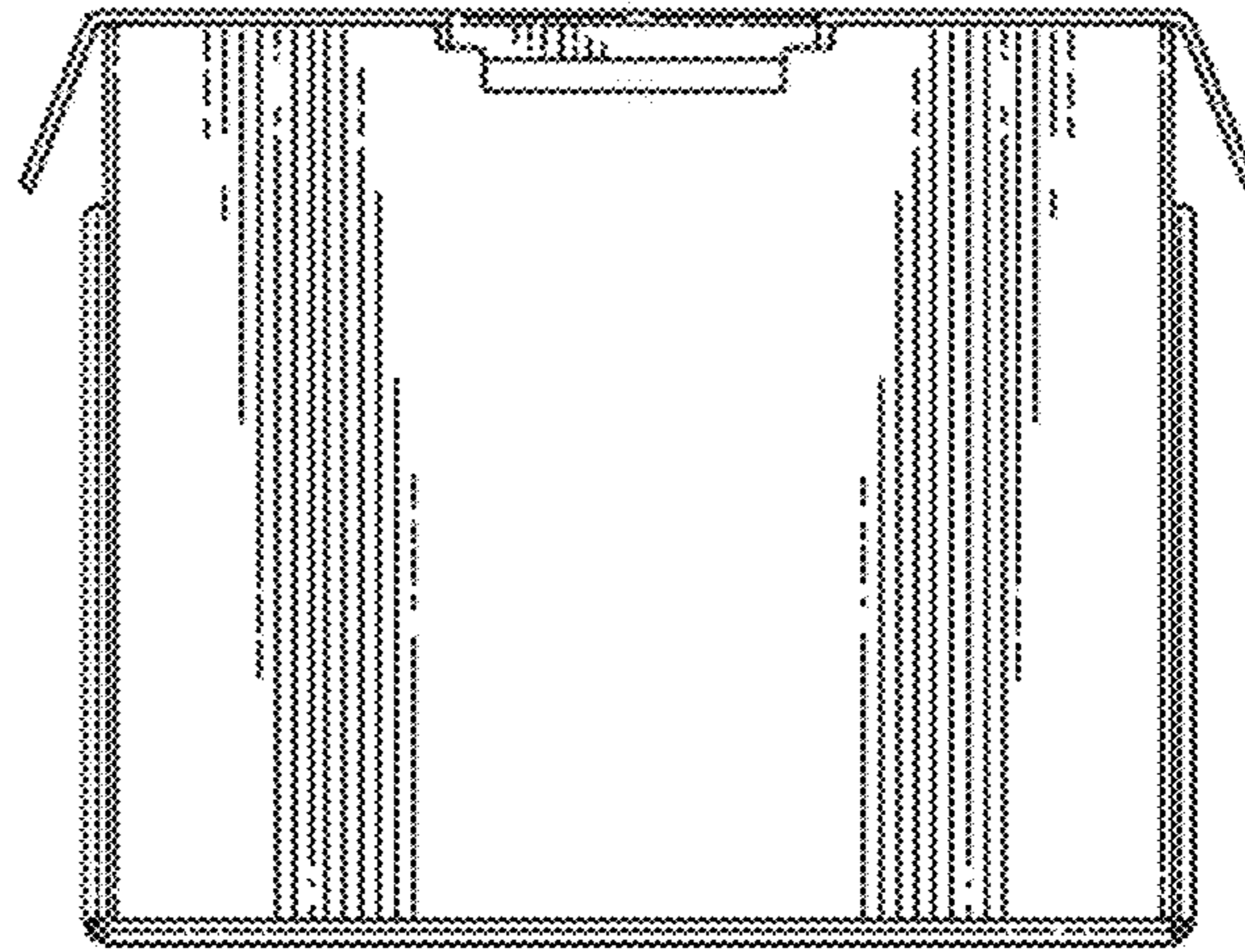

FIG. 6

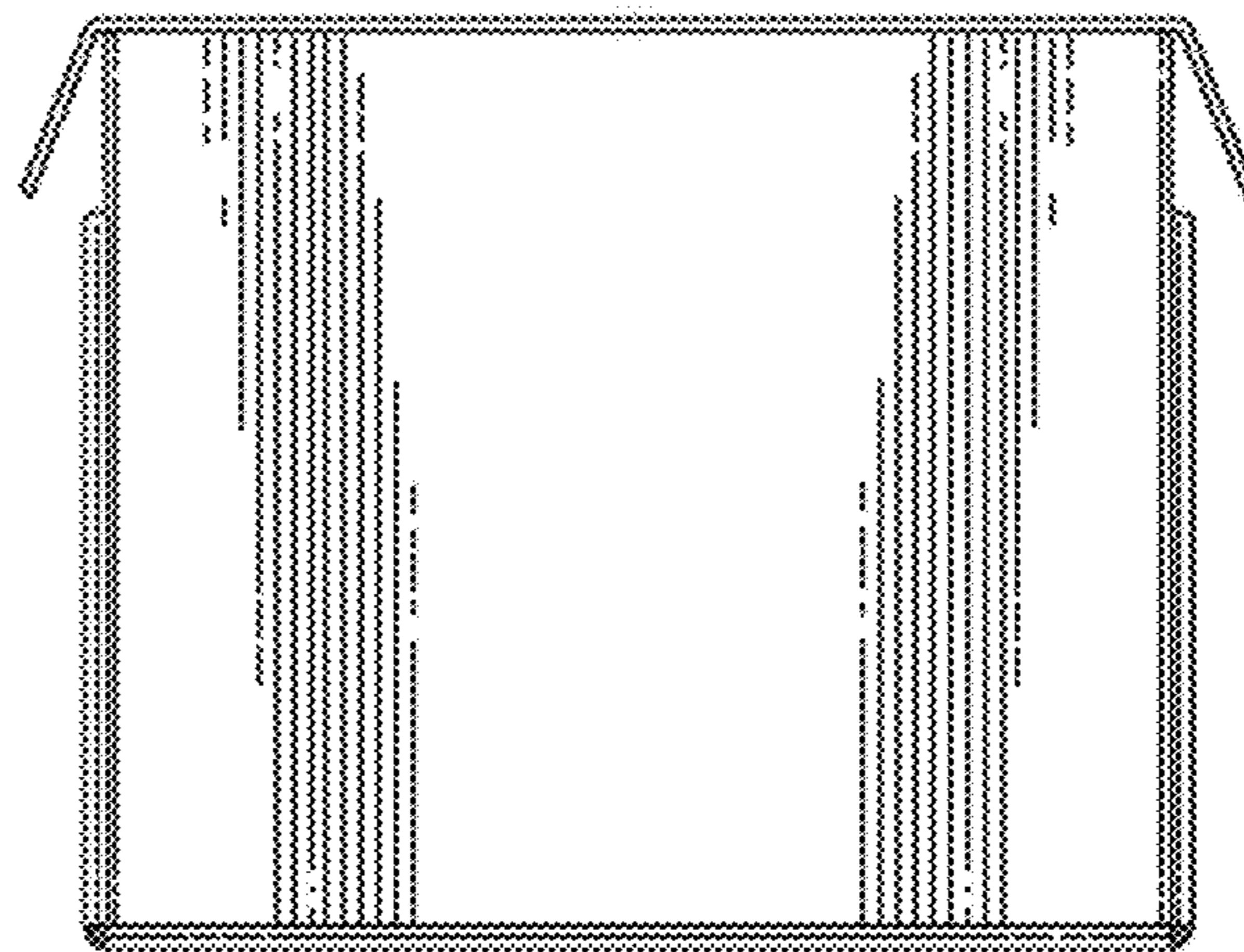

FIG. 7