



US00D834878S

(12) **United States Design Patent**
Moon et al.

(10) **Patent No.:** **US D834,878 S**
(45) **Date of Patent:** **** Dec. 4, 2018**

- (54) **VACUUM BLENDER BASE**
- (71) Applicant: **NuWave, LLC**, Libertyville, IL (US)
- (72) Inventors: **Jung S. Moon**, Long Grove, IL (US);
Eunjung Huh, Grayslake, IL (US);
Byung G. Choi, Lake Villa, IL (US);
Li Xiang Jun, Foshan (CN); **Zeng Qing Ping**, Shanwei (CN)
- (73) Assignee: **NuWave, LLC**, Libertyville, IL (US)
- (**) Term: **15 Years**
- (21) Appl. No.: **29/608,495**
- (22) Filed: **Jun. 22, 2017**
- (51) **LOC (11) Cl.** **31-00**
- (52) **U.S. Cl.**
USPC **D7/386; D7/376; D7/378; D7/384;**
D7/412
- (58) **Field of Classification Search**
USPC **D7/372, 376-386, 412-413, 602, 629,**
D7/665-666, 669, 679, 693-694;
D30/122
CPC **A01K 5/0291; A21C 1/02; A21C 1/04;**
A23N 1/00; A23N 1/02; A47J 43/04;
A47J 43/25; A47J 43/27; A47J 43/042;
A47J 43/044; A47J 43/046; A47J 43/075;
A47J 43/0722; A47J 43/0727; B01F 3/00;
B01F 3/0807; B01F 3/0853; B01F
13/0059; B01F 13/0064; B02C 1/08;
B02C 2/04; B02C 4/42; B02C 4/142;
B02C 4/143; B02C 4/423; B02C 13/1835;
B28C 5/10; B28C 5/12; B28C 5/14;
B28C 5/16
See application file for complete search history.

- 6,681,718 B1 * 1/2004 Mcllarky A01K 5/0291
119/51.11
- D567,578 S * 4/2008 Chiappetta D7/376
- D647,357 S * 10/2011 Audette D7/376
- D664,304 S * 7/2012 Whelan D30/121
- D667,260 S * 9/2012 Lee D7/376
- D677,976 S * 3/2013 Palermo D7/376
- D704,502 S * 5/2014 Coakley D7/376
- D730,682 S * 6/2015 Tu D7/376
- D761,617 S * 7/2016 Dennisur D7/376
- D786,027 S * 5/2017 Kim D7/386
- D793,153 S * 8/2017 Tu D7/376

* cited by examiner

Primary Examiner — Ricky Pham

(74) *Attorney, Agent, or Firm* — Bishop Diehl & Lee, Ltd.

(57) **CLAIM**

The ornamental design for a vacuum blender base, as shown and described.

DESCRIPTION

FIG. 1 is an elevated isometric view of a vacuum blender base showing the new design;
 FIG. 2 is a front view of the vacuum blender base shown in FIG. 1;
 FIG. 3 is a rear view of the vacuum blender base shown in FIG. 1;
 FIG. 4 is a right side view of the vacuum blender base shown in FIG. 1;
 FIG. 5 is a left side view of the vacuum blender base shown in FIG. 1;
 FIG. 6 is a top view of the vacuum blender base shown in FIG. 1; and,
 FIG. 7 is a bottom view of the vacuum blender base shown in FIG. 1.
 The broken lines showing of the appended figures are for purposes of illustrating environmental structures and form no part of the claimed design.

(56) **References Cited**

U.S. PATENT DOCUMENTS

- D320,716 S * 10/1991 Maass D7/378
- D410,816 S * 6/1999 Crescenzi D7/384

1 Claim, 7 Drawing Sheets

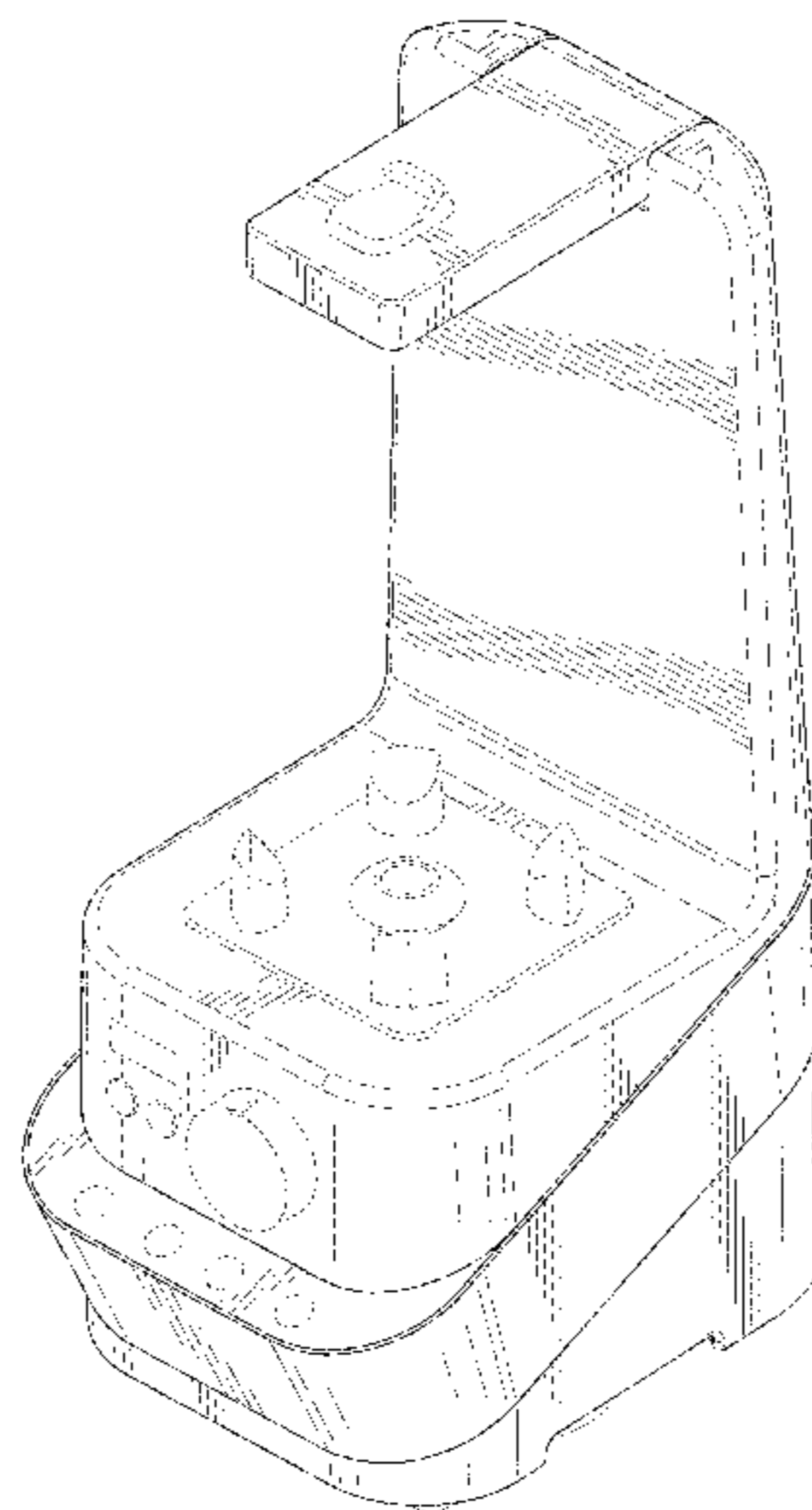

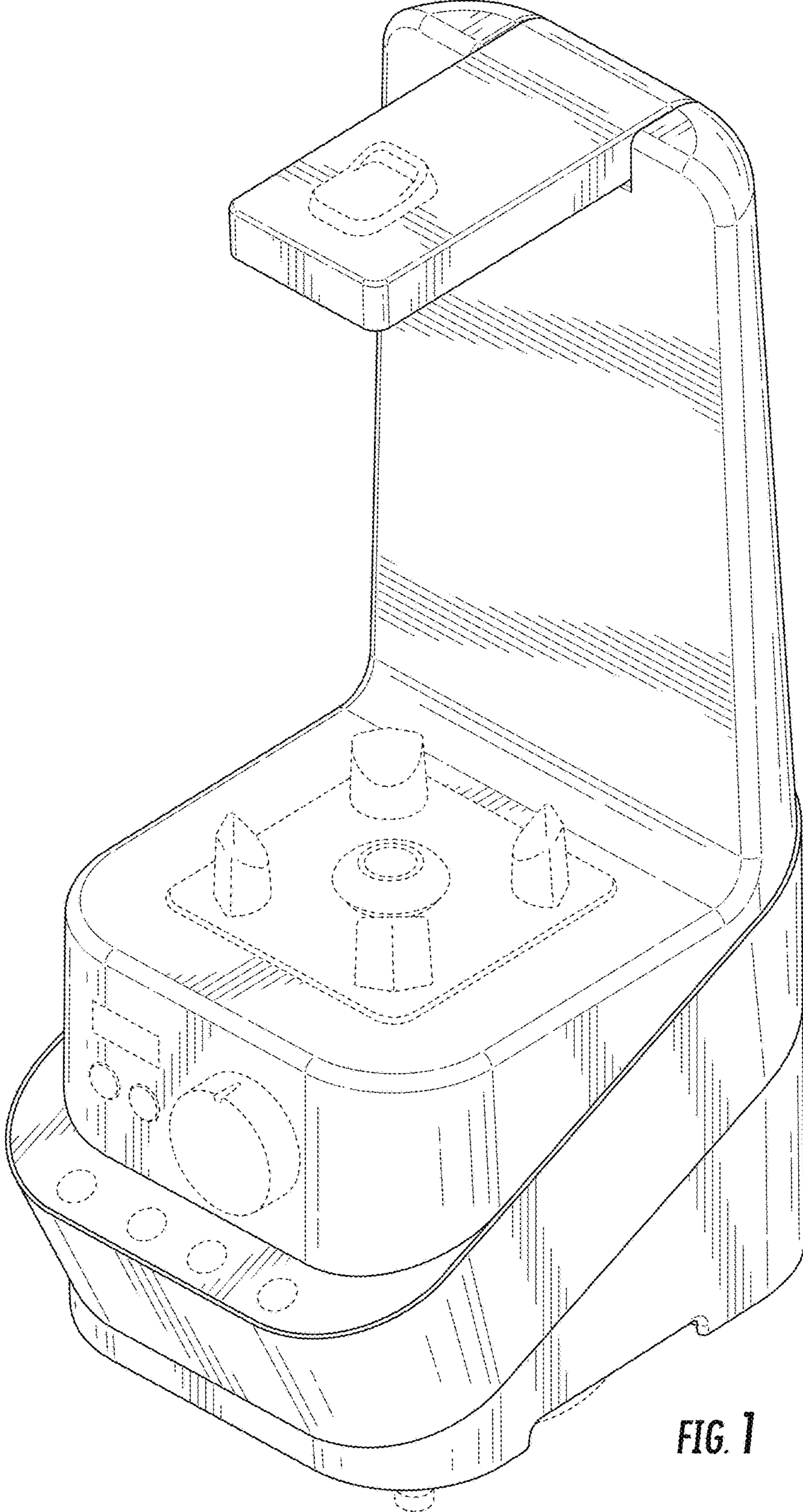

FIG. 1

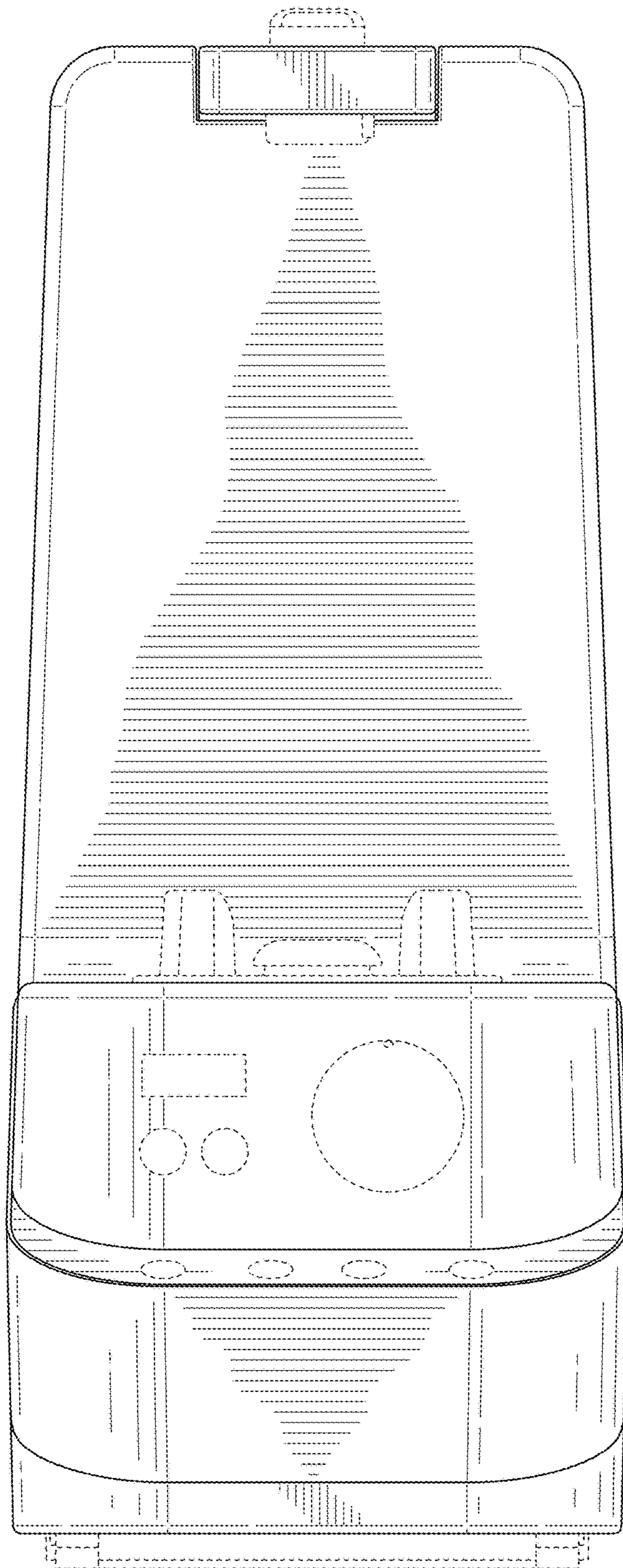

FIG. 2

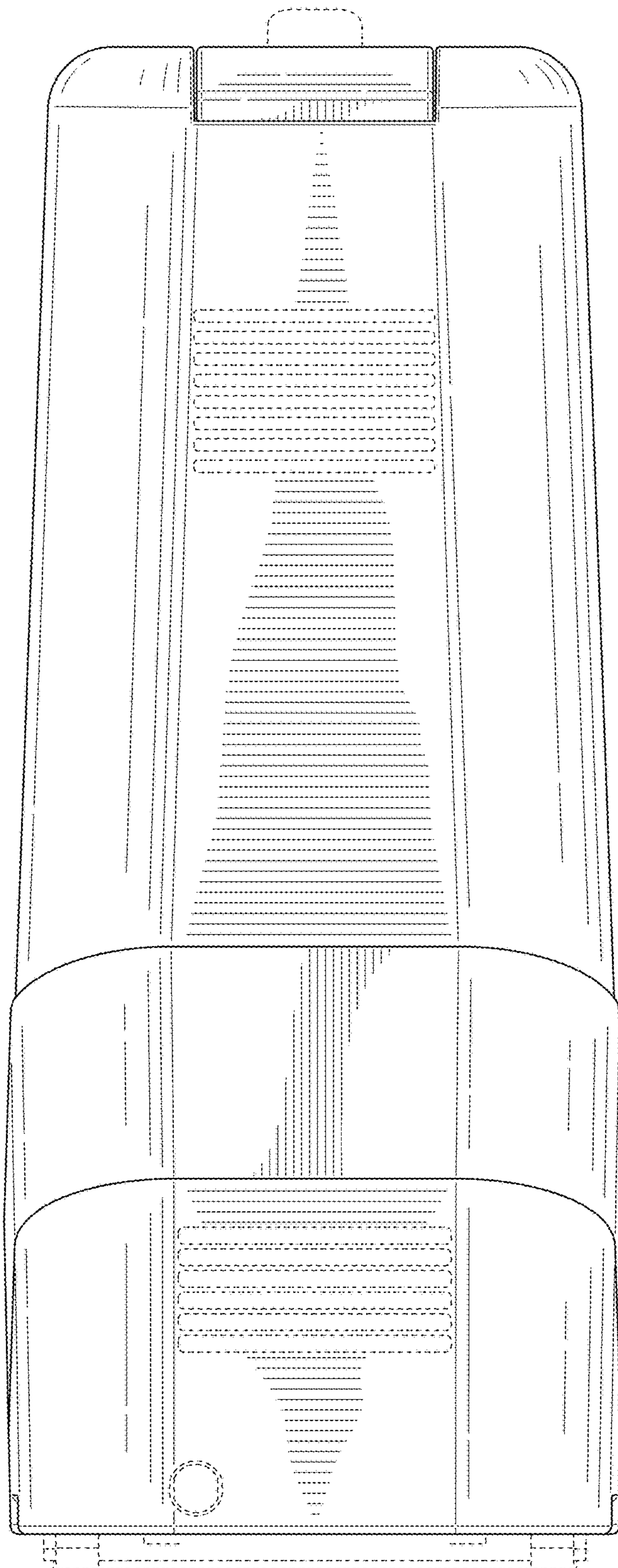

FIG. 3

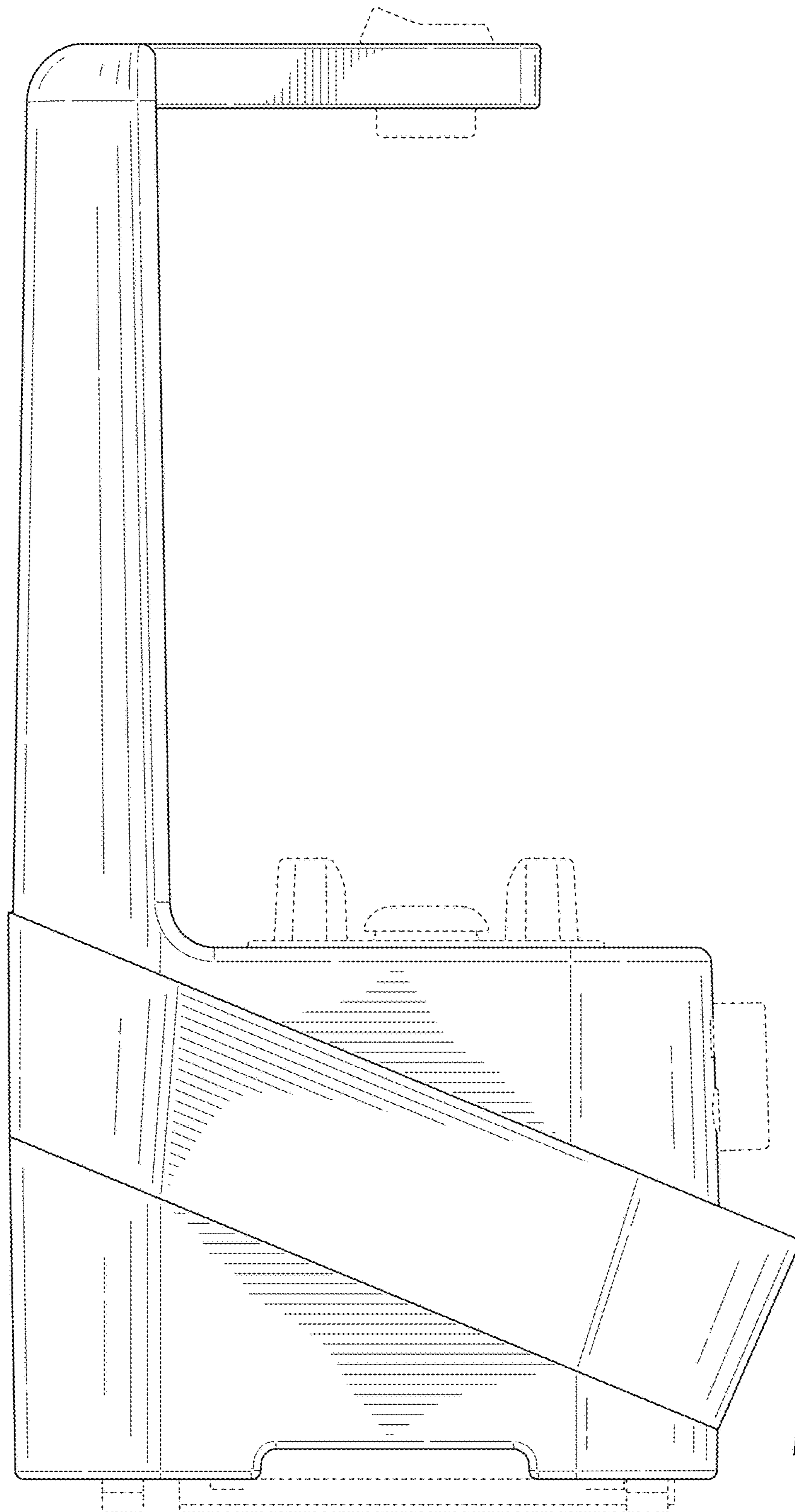

FIG. 4

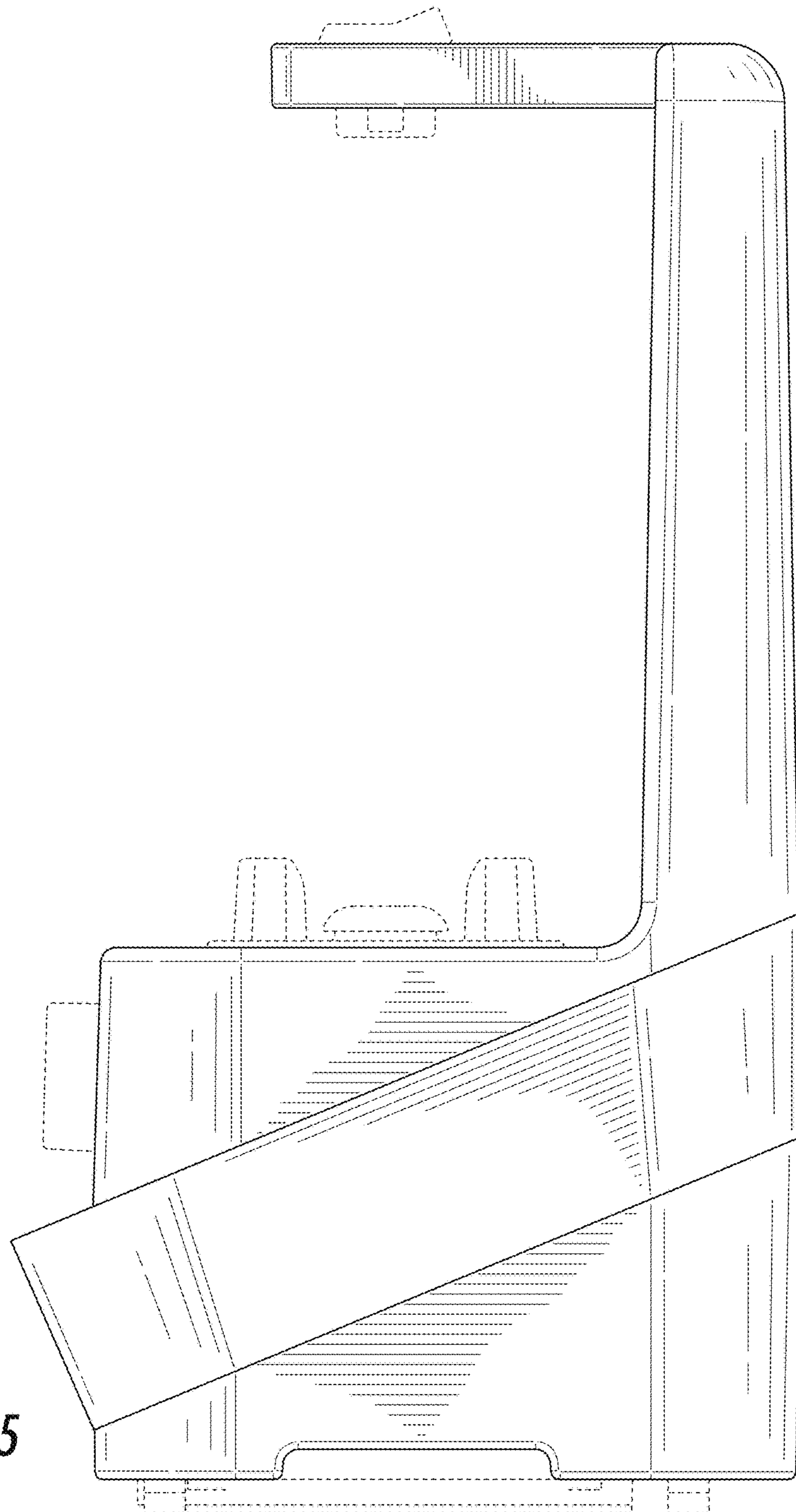

FIG. 5

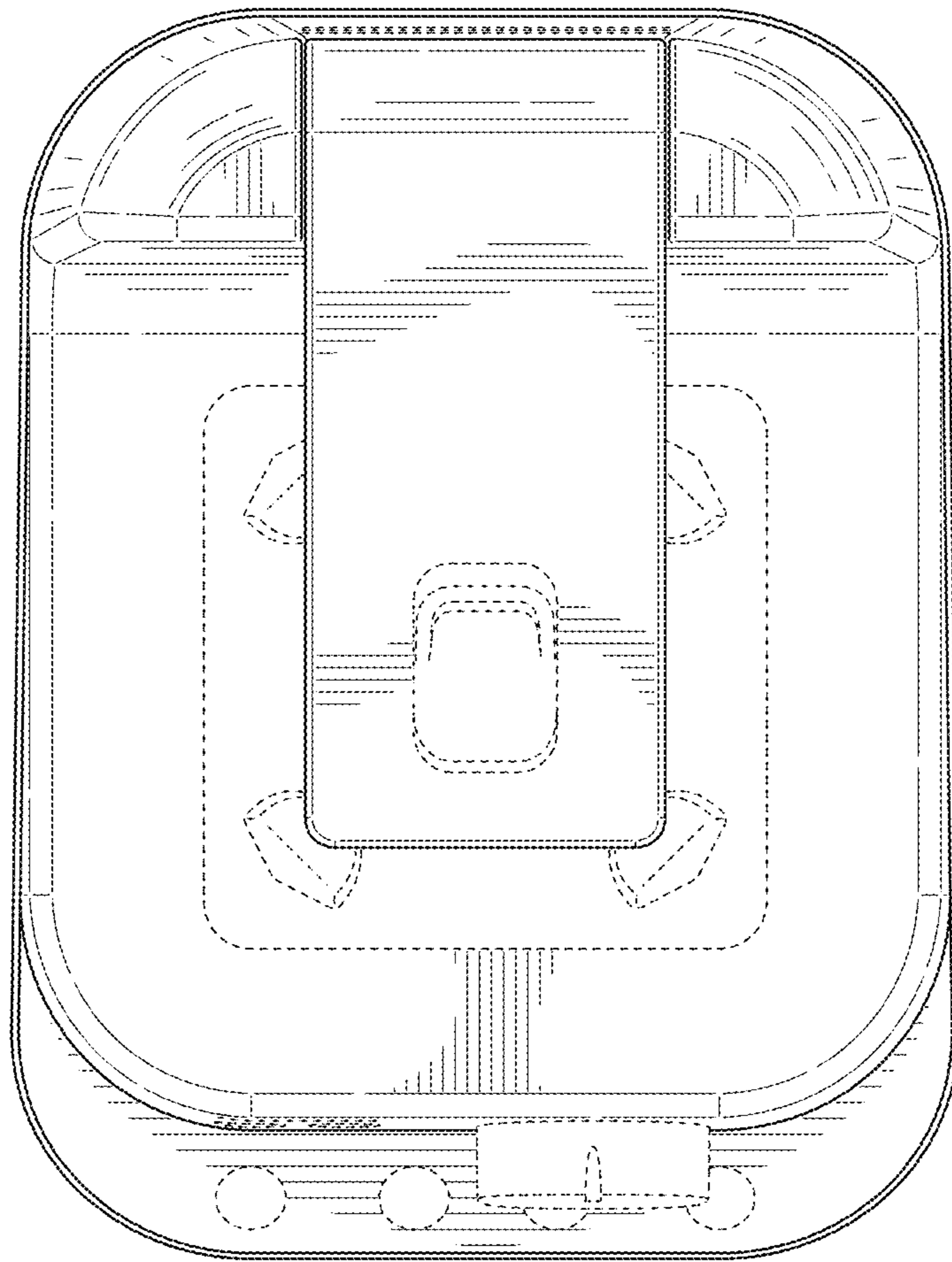

FIG. 6

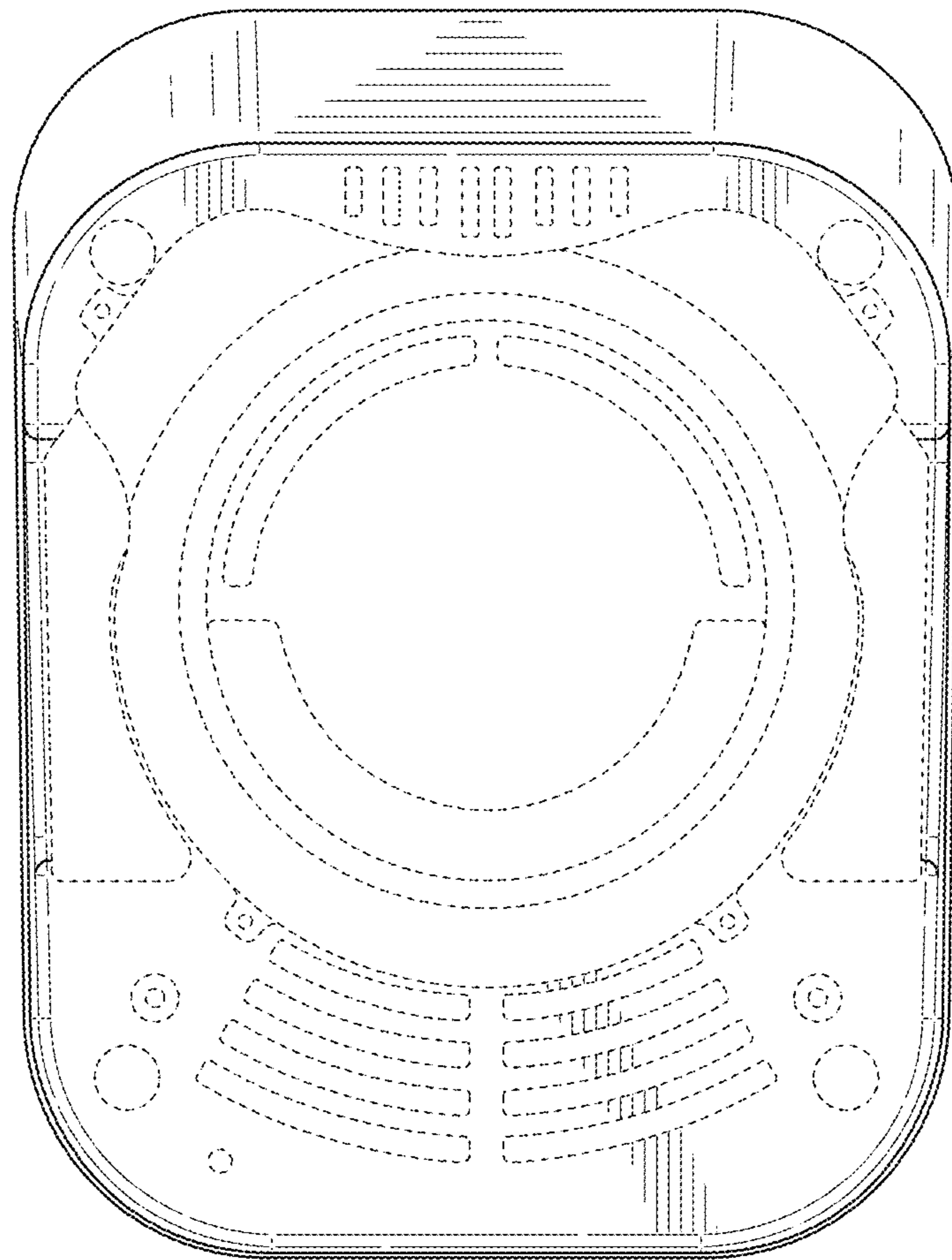

FIG. 7