



US00D834800S

(12) **United States Design Patent** (10) **Patent No.:** **US D834,800 S**
Raysse (45) **Date of Patent:** **** Dec. 4, 2018**

- (54) **SHOE MIDSOLE PERIPHERY**
- (71) Applicant: **Skechers U.S.A., Inc. II**, Manhattan Beach, CA (US)
- (72) Inventor: **David Raysse**, Los Angeles, CA (US)
- (73) Assignee: **Skechers U.S.A., Inc. II**, Manhattan Beach, CA (US)

D452,769 S	1/2002	Jacobs	
D487,184 S *	3/2004	Issler	D2/951
D494,357 S	8/2004	Del Biondi	
D495,128 S *	8/2004	Avar	D2/977
D624,735 S *	10/2010	Raysse	D2/946
D636,566 S	4/2011	Frantz	
D640,863 S *	7/2011	Raysse	D2/946
D643,189 S *	8/2011	Teteriatnikov	D2/946
D643,601 S *	8/2011	Raysse	D2/946

(Continued)

(**) Term: **15 Years**

(21) Appl. No.: **29/647,931**

(22) Filed: **May 16, 2018**

(51) **LOC (11) Cl.** **02-04**

(52) **U.S. Cl.**
USPC **D2/947; D2/960**

(58) **Field of Classification Search**
 USPC D2/902, 906, 908, 916, 918, 925,
 D2/946-962, 977; D12/544; 36/1, 1.5,
 36/3 B, 22 R, 24.5, 25 R, 28, 32 R, 34 R,
 36/59 C, 67 A, 101-107, 114-116, 117.3,
 36/117.4, 124-136
 CPC A43B 13/00; A43B 13/02; A43B 13/023;
 A43B 13/026; A43B 13/04; A43B 13/08;
 A43B 13/10; A43B 13/12; A43B 13/14;
 A43B 13/141; A43B 13/143; A43B
 13/16; A43B 13/18; A43B 13/181; A43B
 13/187; A43B 13/189; A43B 13/20; A43B
 13/22; A43B 13/223; A43B 13/24; A43B
 13/28; A43B 13/30; A43B 13/32; A43B
 13/34; A43B 13/36

See application file for complete search history.

(56) **References Cited**

U.S. PATENT DOCUMENTS

D238,626 S	2/1976	Senter
D379,861 S	6/1997	Wunsch
D402,795 S	12/1998	Moll et al.
D424,284 S	5/2000	Von Conta et al.

OTHER PUBLICATIONS

Relaxed Fit: Expected—Vaspen, Skechers.com, [online], [site visited Jul. 26, 2018]. <URL: <https://www.skechers.com/en-us/style/65765/relaxed-fit-expected-vaspen/blu>> (Year: 2018).*

(Continued)

Primary Examiner — T Chase Nelson

Assistant Examiner — Jonathan J. Han

(74) *Attorney, Agent, or Firm* — Marshall A. Lemer; Marvin H. Kleinberg; Kleinberg & Lemer, LLP

(57) **CLAIM**

The ornamental design for a shoe midsole periphery, as shown and described.

DESCRIPTION

FIG. 1 is a perspective view of a shoe midsole periphery in accordance with my new design.

FIG. 2 is a bottom plan view thereof;

FIG. 3 is a top plan view thereof;

FIG. 4 is a right side view thereof;

FIG. 5 is a left side view thereof;

FIG. 6 is a front elevation thereof; and,

FIG. 7 is a rear elevation view thereof.

The broken lines and the gray faded portions are for environmental purposes only and form no part of the claimed design. The claimed portion does not represent any particular color, material, texture, or finish.

1 Claim, 6 Drawing Sheets

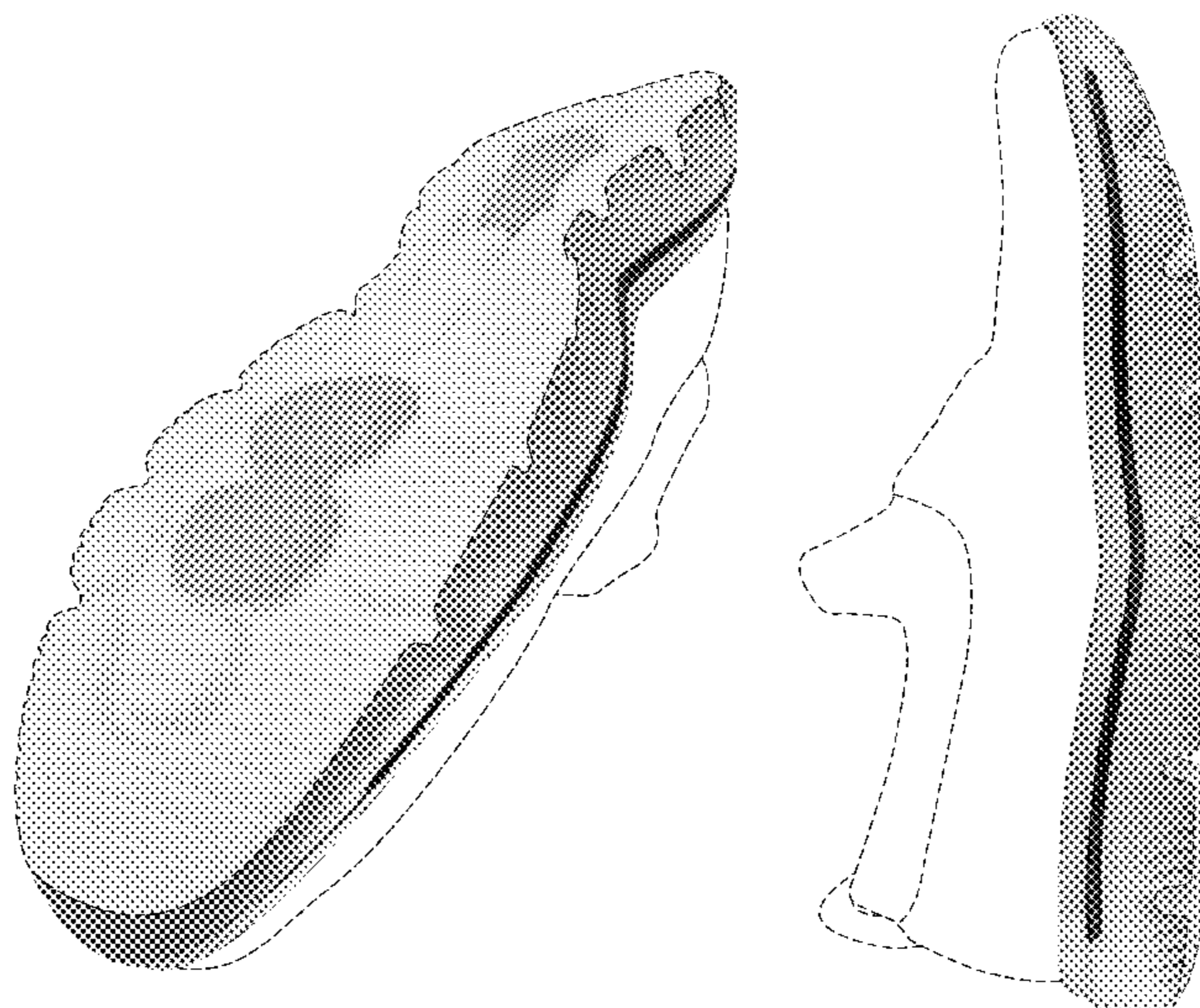

(56)

References Cited

U.S. PATENT DOCUMENTS

D643,602 S * 8/2011 Teteriatnikov D2/946
 D643,604 S 8/2011 Yi
 D661,879 S * 6/2012 Raysse D2/947
 D661,880 S 6/2012 Raysse
 D671,723 S * 12/2012 Teteriatnikov D2/947
 D680,309 S 4/2013 Raysse
 D680,720 S 4/2013 Smith et al.
 D683,937 S 6/2013 Raysse
 D699,423 S 2/2014 Della Valle et al.
 D706,524 S 6/2014 Smith et al.
 D723,772 S 3/2015 Miner
 D723,773 S 3/2015 Raysse
 D725,356 S 3/2015 Miner
 D725,359 S 3/2015 Miner
 D730,032 S 5/2015 D'Arienzo
 D732,811 S 6/2015 D'Arienzo
 D748,383 S 2/2016 Raysse
 D748,900 S 2/2016 Weeks
 D770,740 S * 11/2016 Teteriatnikov D2/947
 D773,791 S * 12/2016 Raysse D2/947
 D782,789 S 4/2017 O'Connor
 D784,667 S * 4/2017 Wright D2/947
 9,635,903 B2 * 5/2017 Lawless A43B 3/0073
 D790,169 S * 6/2017 da Costa Pereira Machado
 D2/947
 D792,067 S * 7/2017 Raysse D2/947

D792,685 S * 7/2017 Parrett D2/947
 D793,687 S * 8/2017 Cin D2/958
 D794,293 S * 8/2017 Robusti D2/954
 D794,294 S * 8/2017 Robusti D2/954
 9,717,303 B2 * 8/2017 Walker A43B 3/0057
 D796,170 S * 9/2017 Raysse D2/947
 D801,650 S * 11/2017 Nykreim D2/947
 D809,252 S * 2/2018 Brunner D2/902
 D810,406 S * 2/2018 Teteriatnikov D2/947
 D814,155 S * 4/2018 Hernandez D2/947
 D817,613 S * 5/2018 Atwell D2/947
 9,999,274 B2 * 6/2018 Henderson A43B 3/0057
 D821,714 S * 7/2018 Chang D2/947
 D822,968 S * 7/2018 Moranges D2/957
 2013/0174444 A1 * 7/2013 Jacobs A43B 5/12
 36/28
 2015/0237958 A1 * 8/2015 Cross A43B 13/181
 36/103

OTHER PUBLICATIONS

Relaxed Fit: Harper—Mezo, Skechers.com, [online], [site visited Jul. 26, 2018]. <URL: <https://www.skechers.com/en-us/style/65578/relaxed-fit-harper-mezo/blk>> (Year: 2018).*

Nike Free Run 3 Review, SoleReview.com, Apr. 14, 2012, [online], [site visited Jul. 26, 2018]. <URL: <https://www.solereview.com/nike-free-run-3-review/>> (Year: 2012).*

* cited by examiner

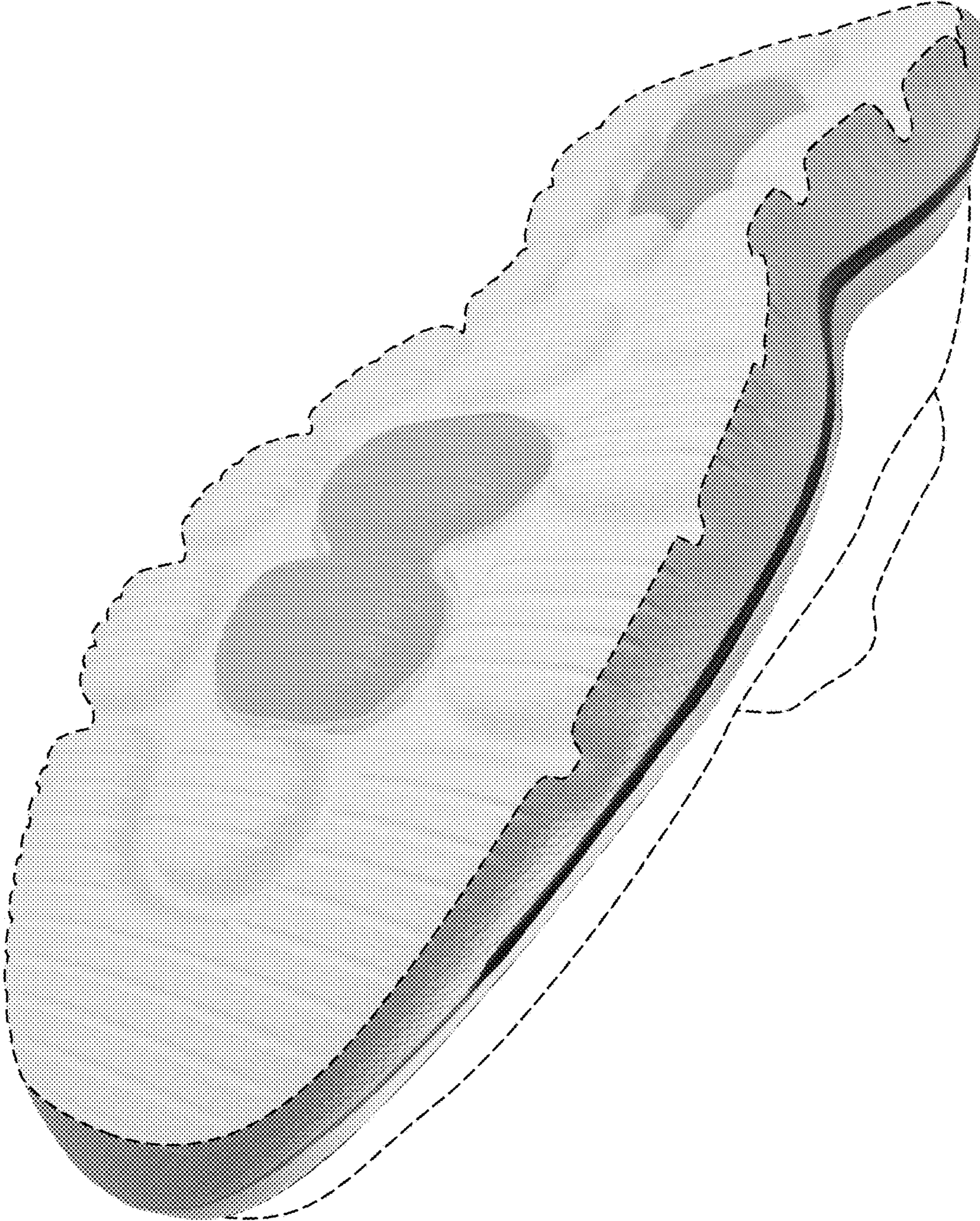

FIG. 1



FIG. 2

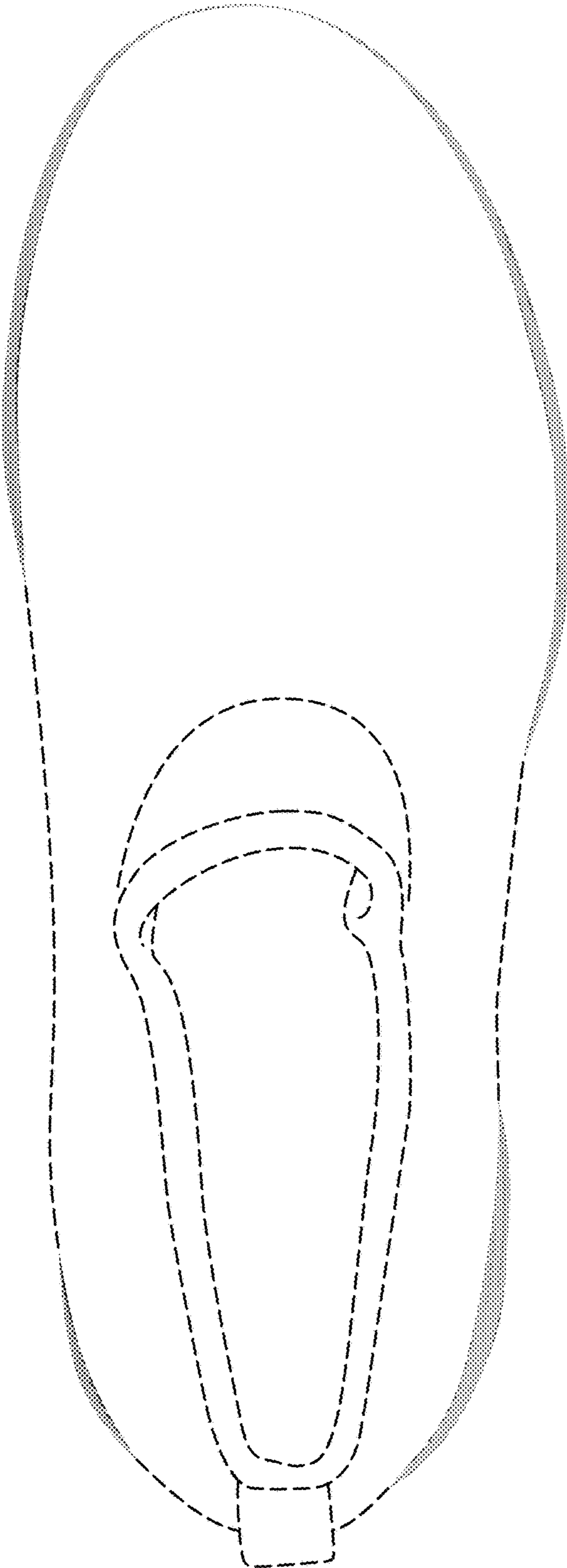

FIG. 3

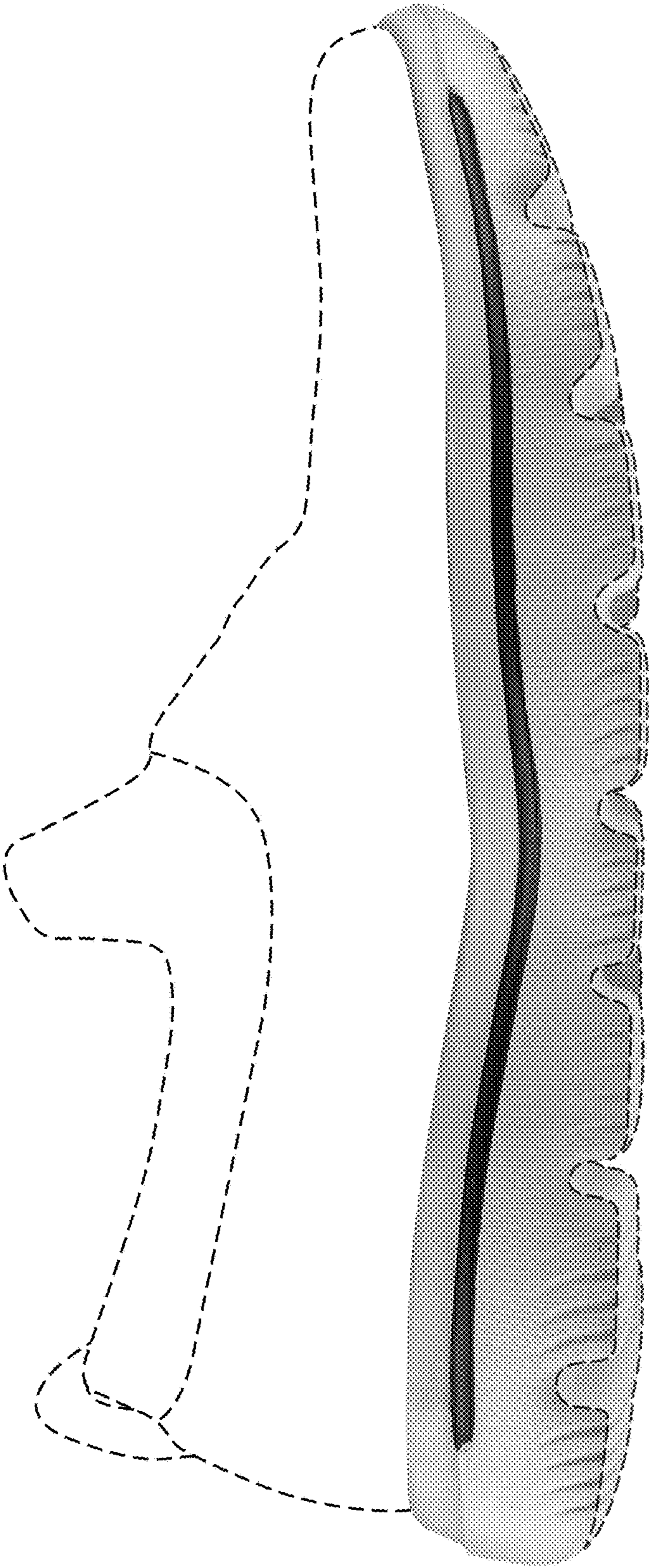

FIG. 4

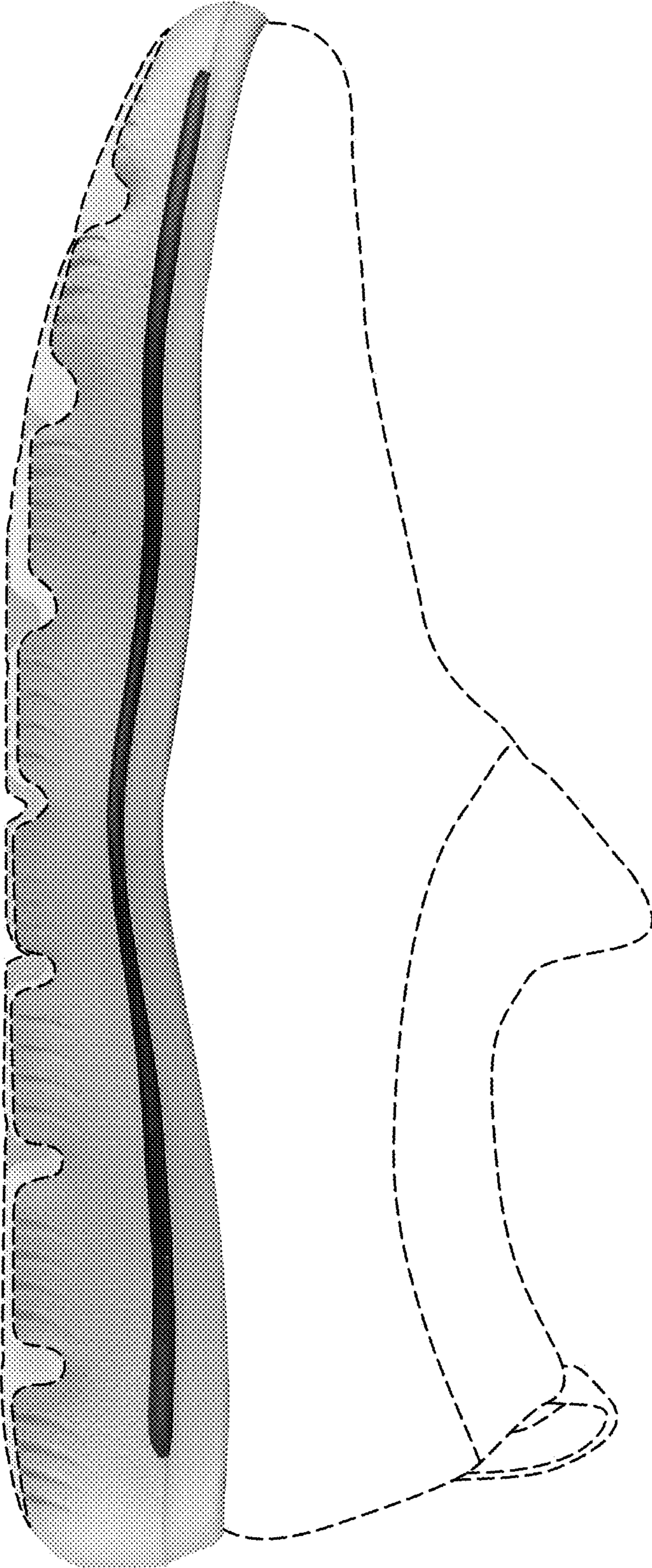

FIG. 5

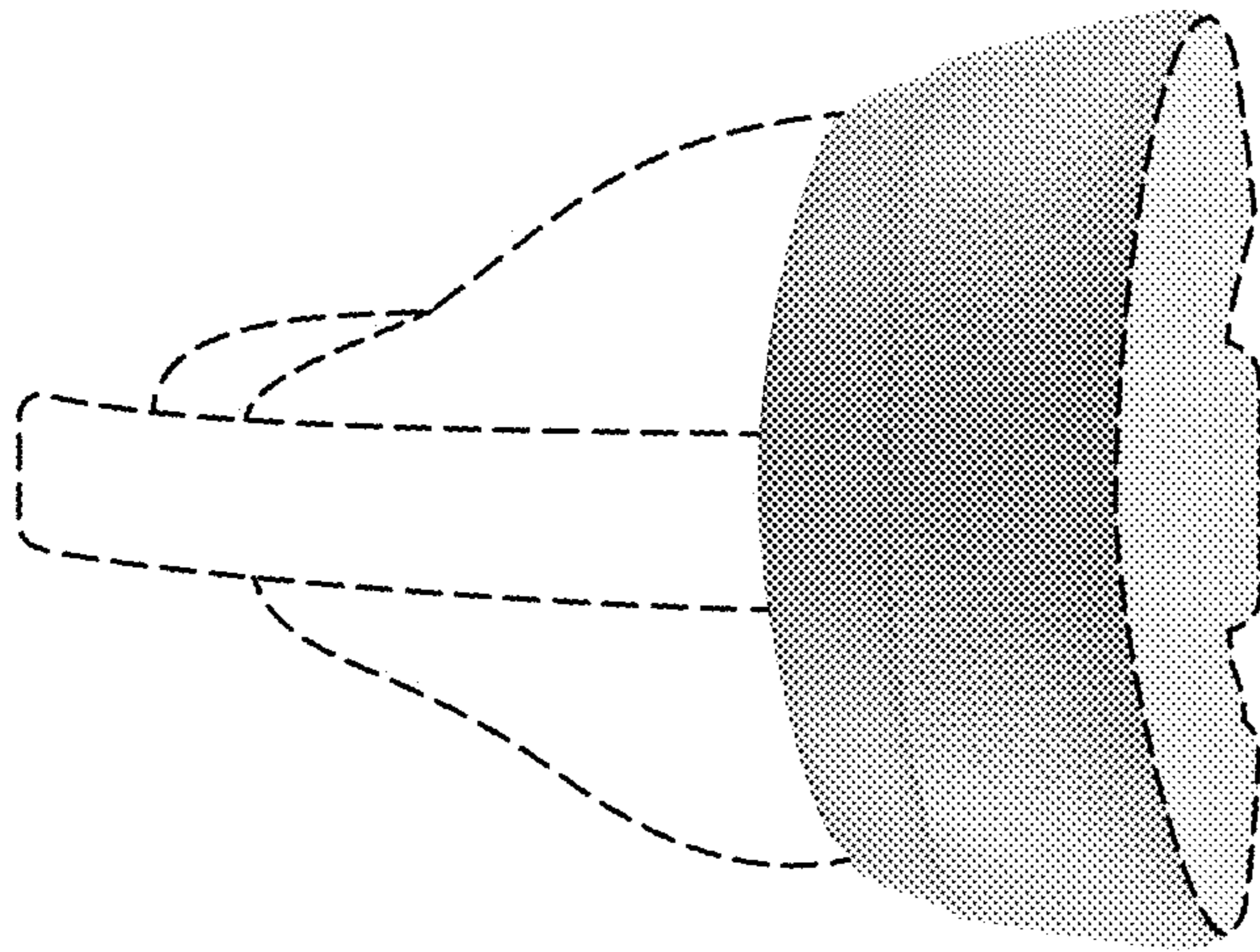

FIG. 7

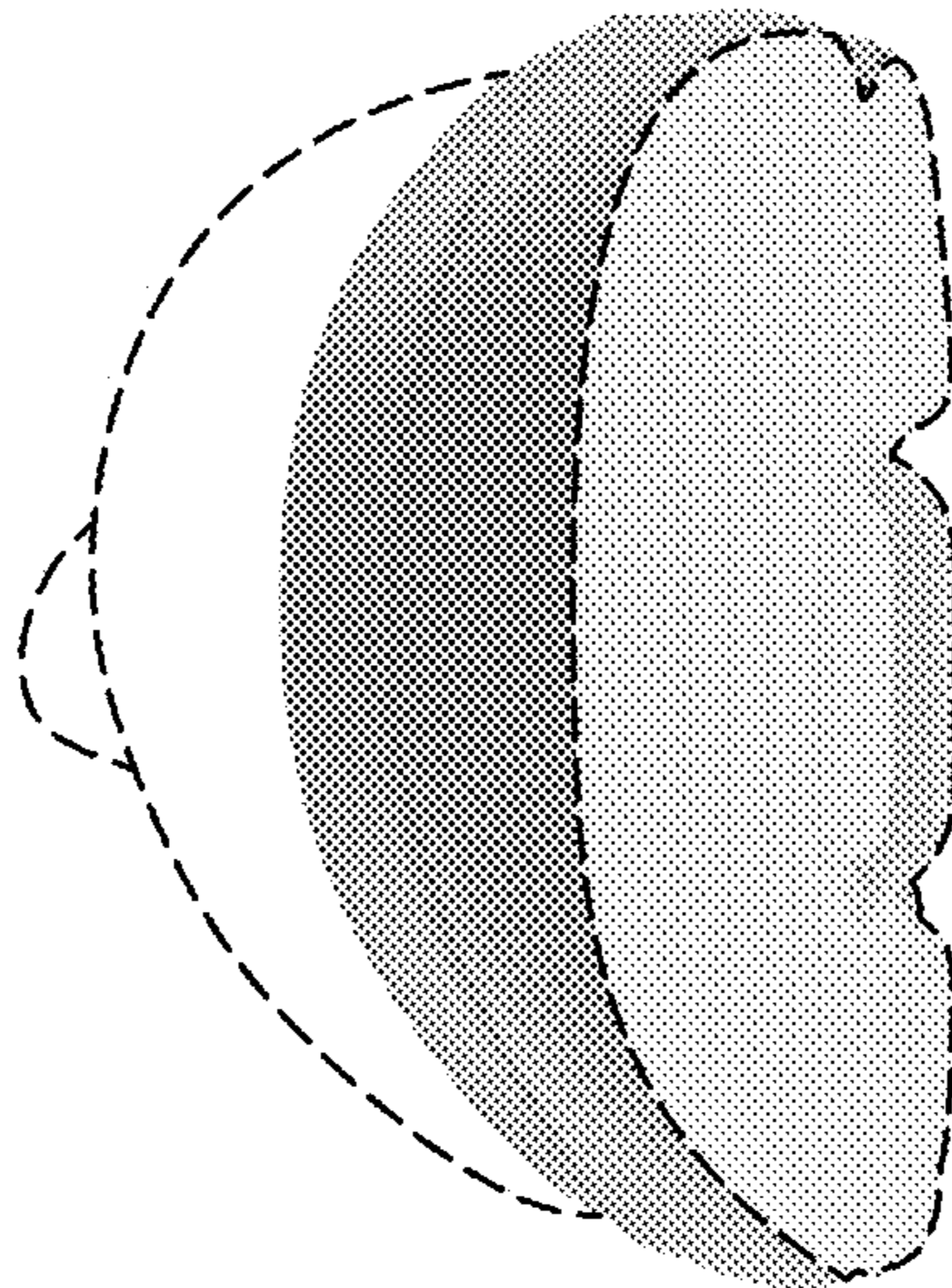

FIG. 6