



US00D834793S

(12) **United States Design Patent** (10) **Patent No.:** **US D834,793 S**  
**Bates** (45) **Date of Patent:** **\*\* Dec. 4, 2018**

(54) **BANDANA WITH VISOR**  
(71) Applicant: **Valerie Bates**, Oak park, IL (US)  
(72) Inventor: **Valerie Bates**, Oak park, IL (US)  
(\*\*) Term: **15 Years**  
(21) Appl. No.: **29/569,031**  
(22) Filed: **Jun. 23, 2016**  
(51) **LOC (11) Cl.** ..... **02-03**  
(52) **U.S. Cl.**  
USPC ..... **D2/879; D2/876**  
(58) **Field of Classification Search**  
USPC ..... D2/500, 502, 508, 865, 866, 867, 870,  
D2/872, 876, 878, 879, 880, 881, 882,  
D2/883, 884, 891, 892, 893, 895;  
D29/102, 106  
CPC ..... A41D 23/00; A42B 1/00; A42B 1/002;  
A42B 1/004; A42B 1/006; A42B 1/02;  
A42B 1/04; A42B 1/041; A42B 1/045;  
A42B 1/06; A42B 1/062; A42B 1/063;  
A42B 1/064; A42B 1/065; A42B 1/066;  
(Continued)

(56) **References Cited**  
U.S. PATENT DOCUMENTS  
1,819,558 A \* 8/1931 Husman ..... A42B 1/045  
2/174  
2,193,271 A \* 3/1940 Cowherd ..... A42B 1/041  
2/171  
D135,321 S \* 3/1943 Harpignies ..... 2/195.1  
(Continued)

**OTHER PUBLICATIONS**  
Billi Bandana White, [on-line]; [wayback machine crawlback date on the Internet Sep. 14, 2011]; [retrieved from the Internet Jan. 9, 2017]; URL: <https://web.archive.org/web/20110914210401/http://www.billibandana.com/bb-white.html>. (1 page).  
(Continued)

*Primary Examiner* — Karen E Eldridge Powers  
*Assistant Examiner* — Jasmine Mlinarcik  
(74) *Attorney, Agent, or Firm* — Boyle Fredrickson, S.C.

(57) **CLAIM**

The ornamental design of a bandana with visor, as shown and described.

**DESCRIPTION**

FIG. 1 is a top plan view of a bandana with visor incorporating my new design;  
FIG. 2 is a bottom plan view thereof;  
FIG. 3 is an isometric view of the bandana with visor of my new design in a first configuration as shown in a condition of use;  
FIG. 4 is a top plan view thereof;  
FIG. 5 is a rear elevation view thereof;  
FIG. 6 is an isometric view of the bandana with visor of my new design in a second configuration as shown in a condition of use;  
FIG. 7 is a top plan view thereof;  
FIG. 8 is a rear elevation view thereof;  
FIG. 9 is an isometric view of the bandana with visor of my new design in a third configuration as shown in a condition of use;  
FIG. 10 is a top plan view thereof;  
FIG. 11 is a rear elevation view thereof;  
FIG. 12 is an isometric view of the bandana with visor of my new design in a fourth configuration as shown in a condition of use;  
FIG. 13 is a top plan view thereof; and,  
FIG. 14 is a rear elevation view thereof.

The broken lines within the bounds of the claimed design represent environmental structure that forms no part of the claimed design. The broken-line outline of the partial human figure represents how the claimed design may appear when worn, but forms no part of the claimed design.

**1 Claim, 5 Drawing Sheets**

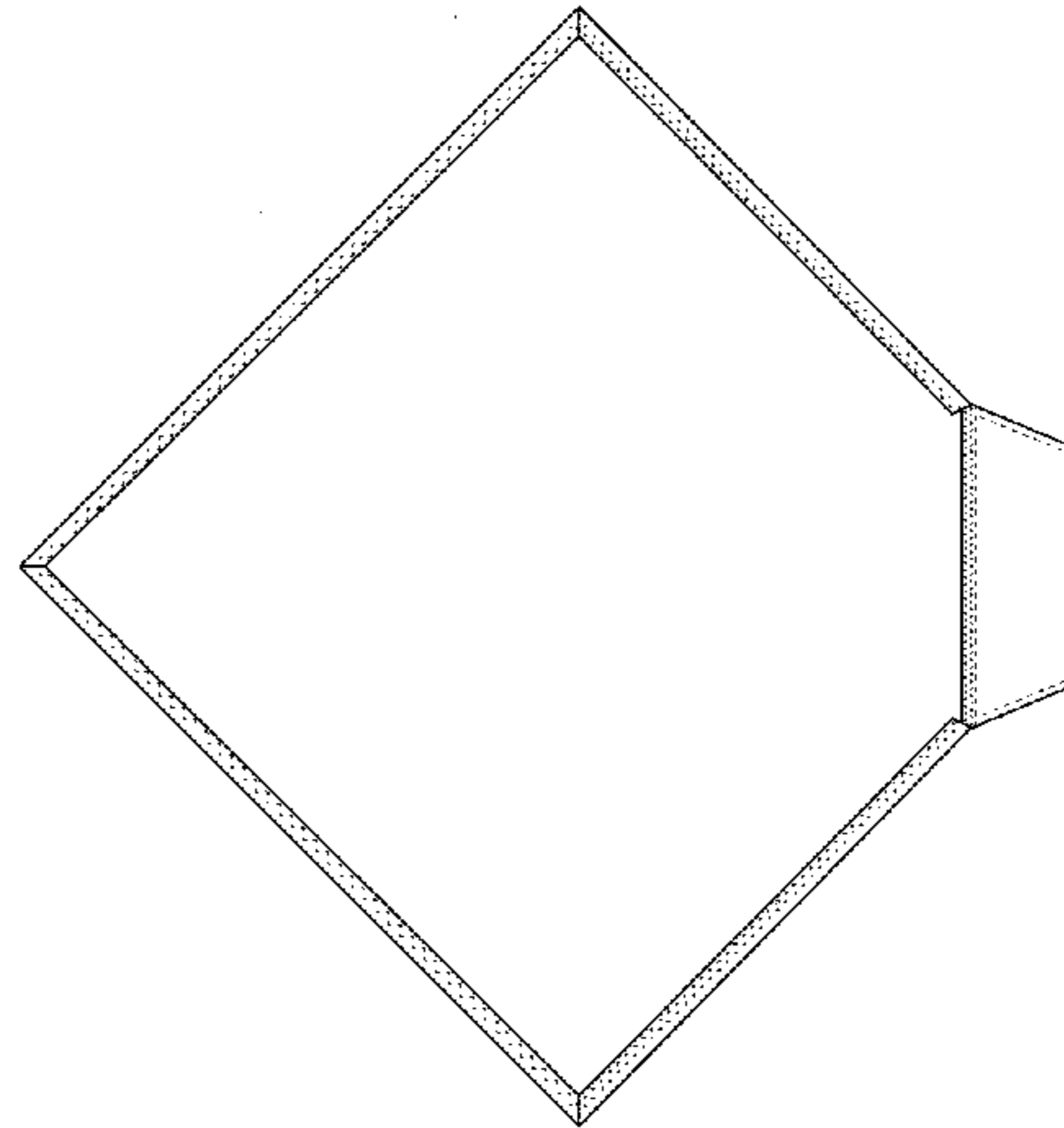
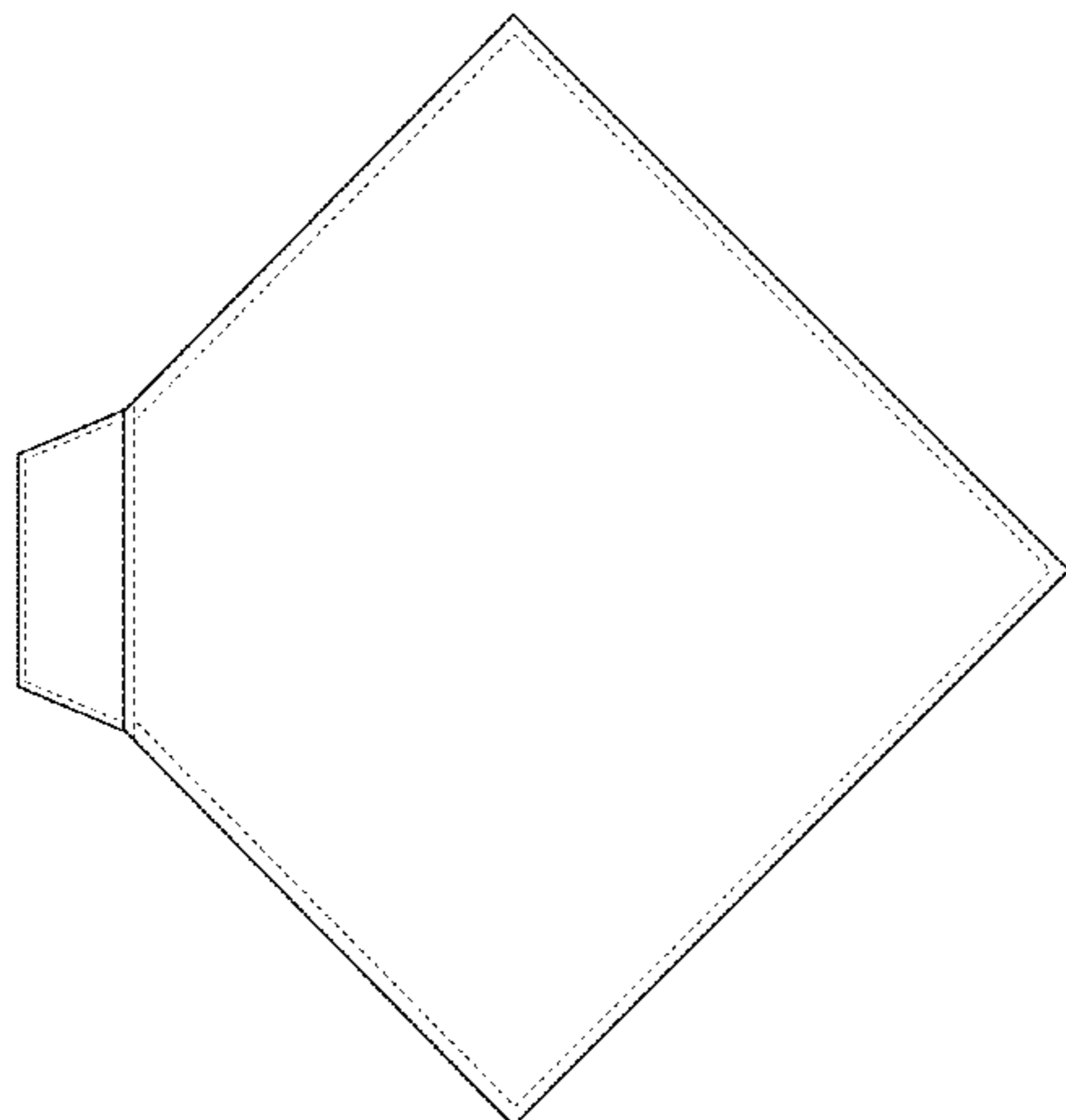

(58) **Field of Classification Search**  
 CPC ..... A42B 1/18; A42B 1/205; A42B 1/206;  
 A42B 1/24; A42B 3/0406; A42C 5/00  
 See application file for complete search history.

(56) **References Cited**

U.S. PATENT DOCUMENTS

2,704,366	A *	3/1955	Arnold .....	A42B 1/066
				2/171.01
D183,646	S *	10/1958	Cash .....	D2/502
2,859,448	A	11/1958	Gaichel	
3,480,970	A	12/1969	Gettinger	
5,048,128	A *	9/1991	Watson, Jr. ....	A42B 1/066
				2/171
5,253,389	A	10/1993	Patterson, Jr.	
5,381,559	A *	1/1995	Wakefield, III .....	A42B 1/066
				2/172
D358,006	S *	5/1995	Chisolm .....	D2/893
5,493,732	A *	2/1996	Fawkes .....	A42B 1/201
				2/195.1
5,542,127	A *	8/1996	Bezanis .....	A42B 1/066
				2/172
D399,993	S *	10/1998	Delgado .....	D2/881
5,875,493	A *	3/1999	MacDonald .....	A01K 55/00
				2/10
D474,578	S	5/2003	Johnson	
D475,834	S *	6/2003	Margiela .....	D2/500
D482,843	S *	12/2003	Burnett .....	D2/500
D490,193	S *	5/2004	D'Anza .....	D30/144
D583,126	S *	12/2008	Sannomiya .....	D2/500
D627,955	S *	11/2010	Schrab .....	D2/881

D641,544	S *	7/2011	Fuglsang .....	D2/880
D645,646	S *	9/2011	Fuglsang .....	D2/880
D688,850	S *	9/2013	Parker .....	D2/500
D746,555	S *	1/2016	Branson .....	D2/881
D746,556	S *	1/2016	Vifquain .....	D2/881
2005/0057054	A1 *	3/2005	Hopkins .....	A01K 27/006
				294/1.3
2006/0005297	A1 *	1/2006	Blecha .....	A42B 1/041
				2/207
2006/0010567	A1 *	1/2006	Vazquez .....	A41D 23/00
				2/175.1
2008/0148466	A1 *	6/2008	Wohl .....	A42B 1/062
				2/209.3

OTHER PUBLICATIONS

Bandana Hat, [on-line]; [wayback machine crawlback date on the Internet Jul. 24, 2013]; [retrieved from the Internet Jan. 9, 2017]; URL: <https://web.archive.org/web/20130724002606/http://bandana-hat.com/Fall%20Hats%20+%20Red%20Hat.htm>. (3 pages).\*

U.S. Trademark Application #86401063 (now Registered Trademark #4893523) for VisorWrap by Bates Products, LLC. Publication Date: May 5, 2015. Retrieved on Jan. 9, 2017.\*

VisorWrap demo, [on-line]; [posted to the Internet Sep. 14, 2015]; [retrieved from the Internet Jan. 9, 2017]; URL: <https://www.youtube.com/watch?v=Etilr-N8qEM>. (6 pages).\*

Royal Blue VisorWrap, [on-line]; [publication date unknown]; [retrieved from the Internet Jan. 9, 2017]; URL: <https://www.visorwrap.com/product/royal-blue/>. (1 page).\*

\* cited by examiner

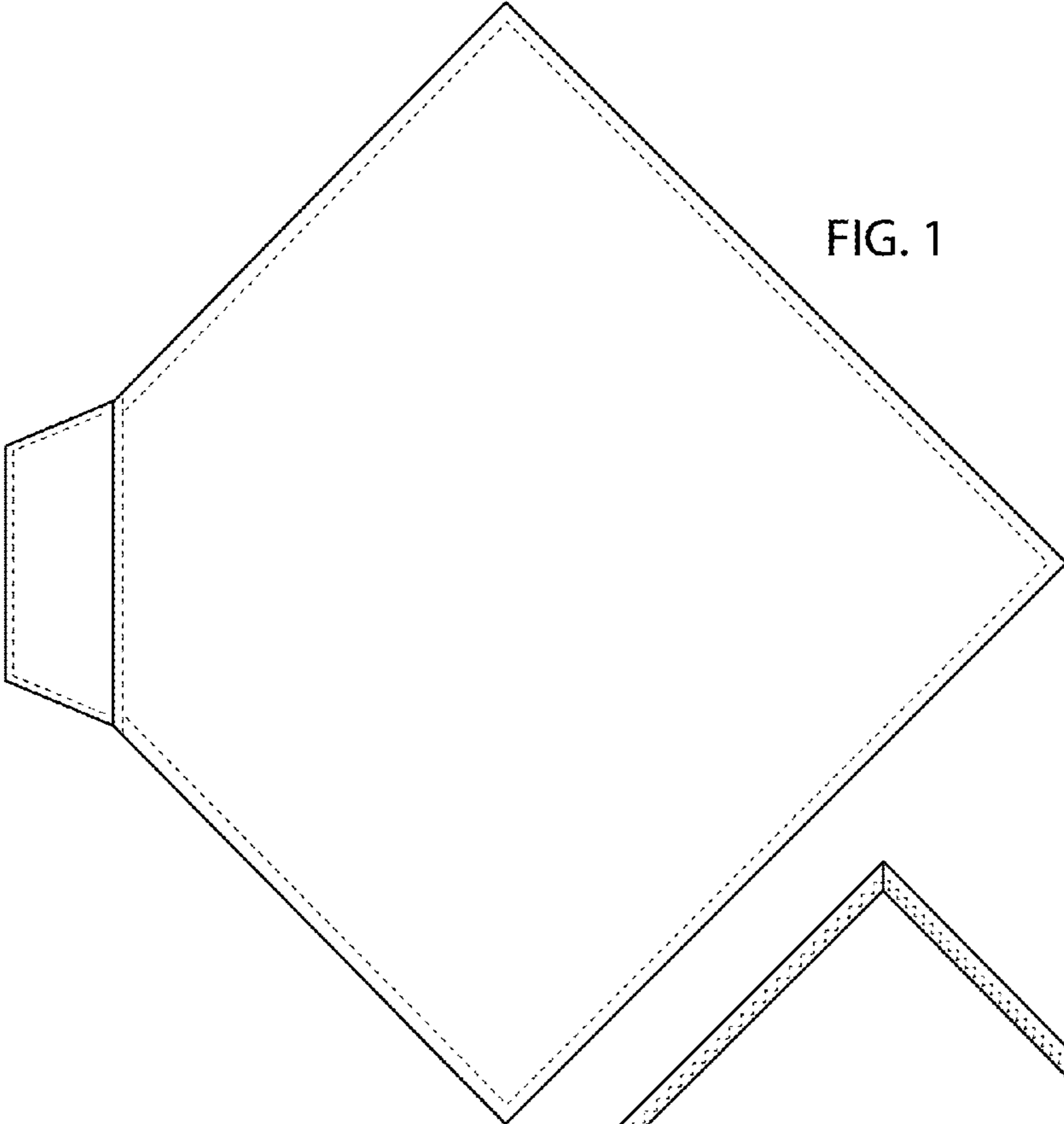

FIG. 1

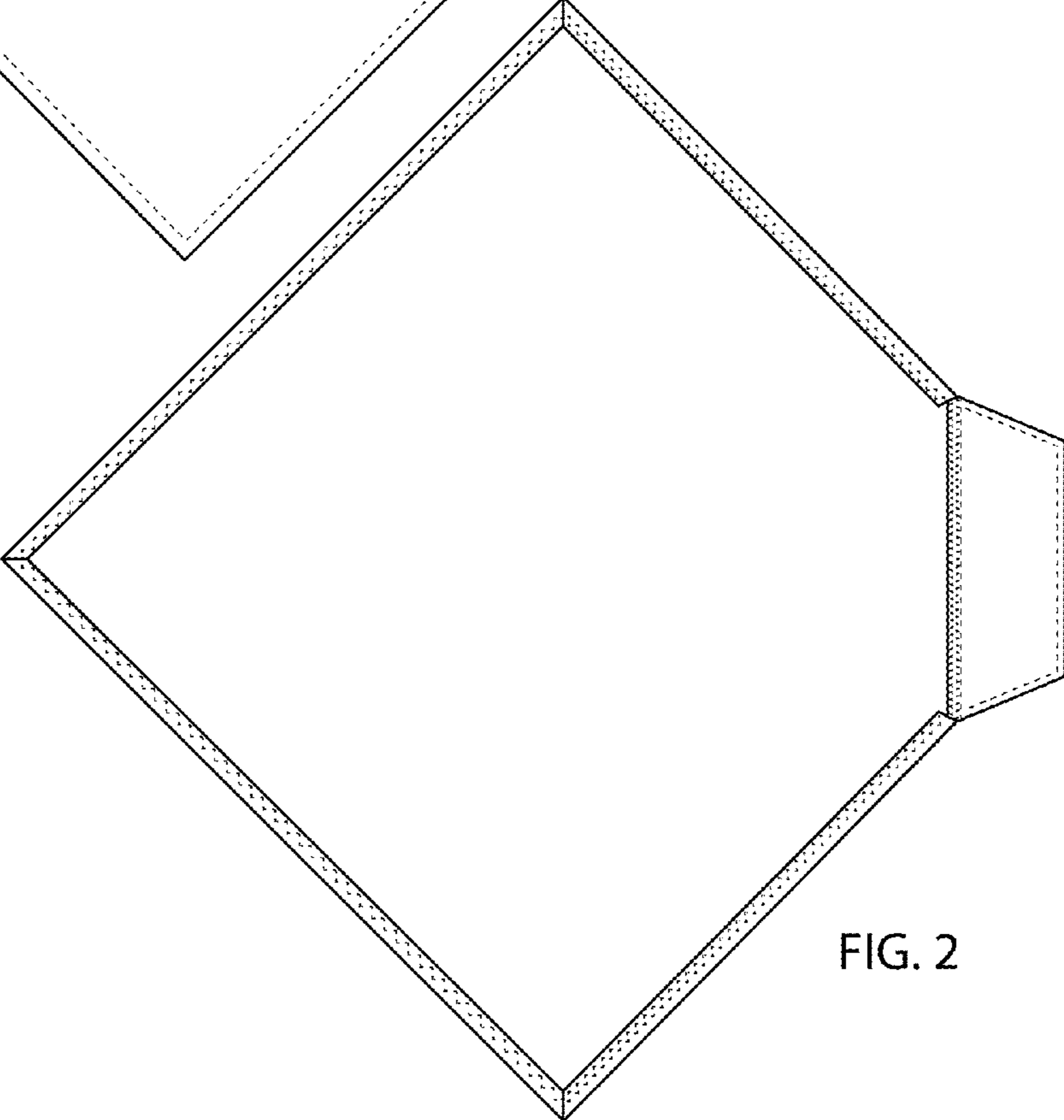

FIG. 2

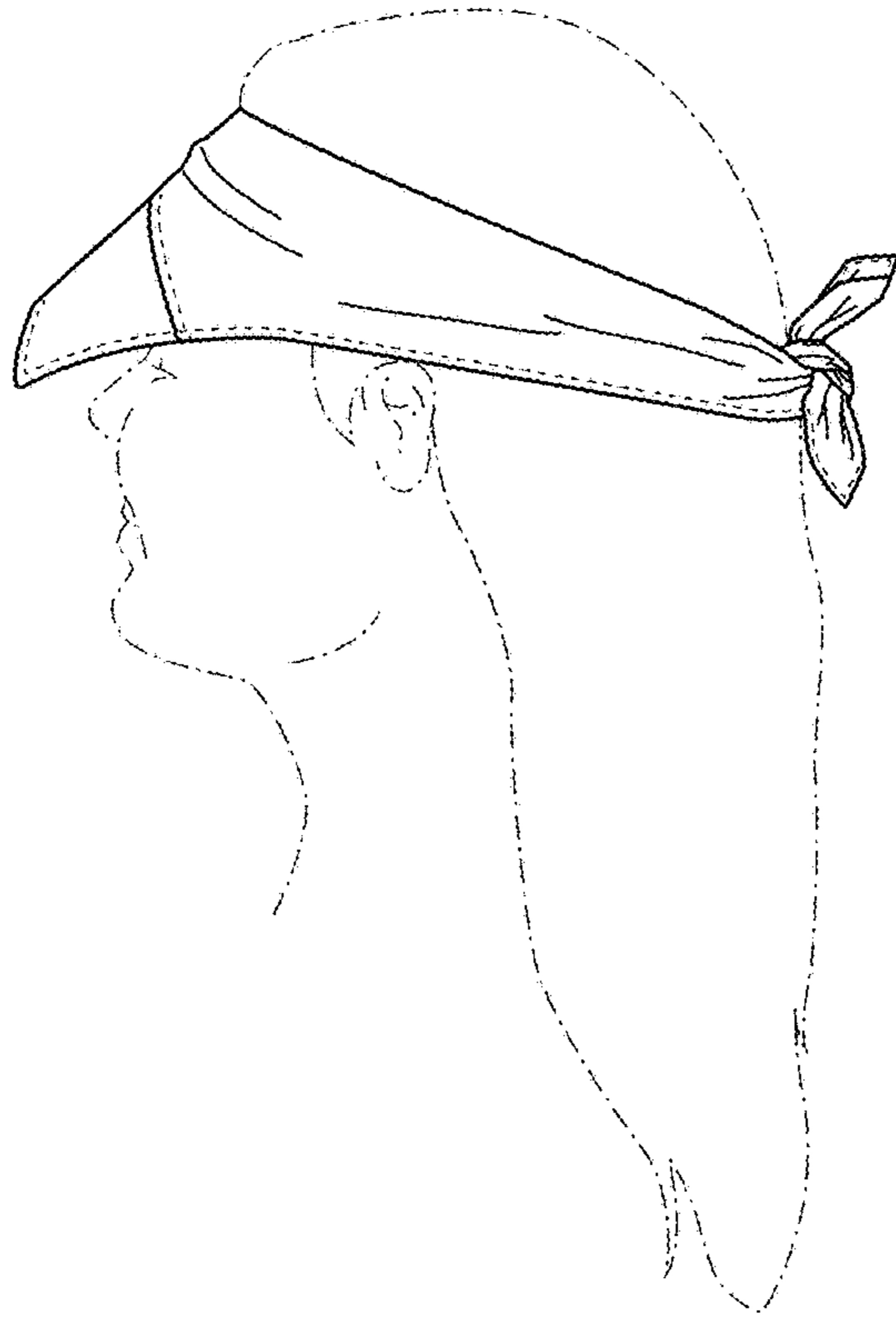

FIG. 3

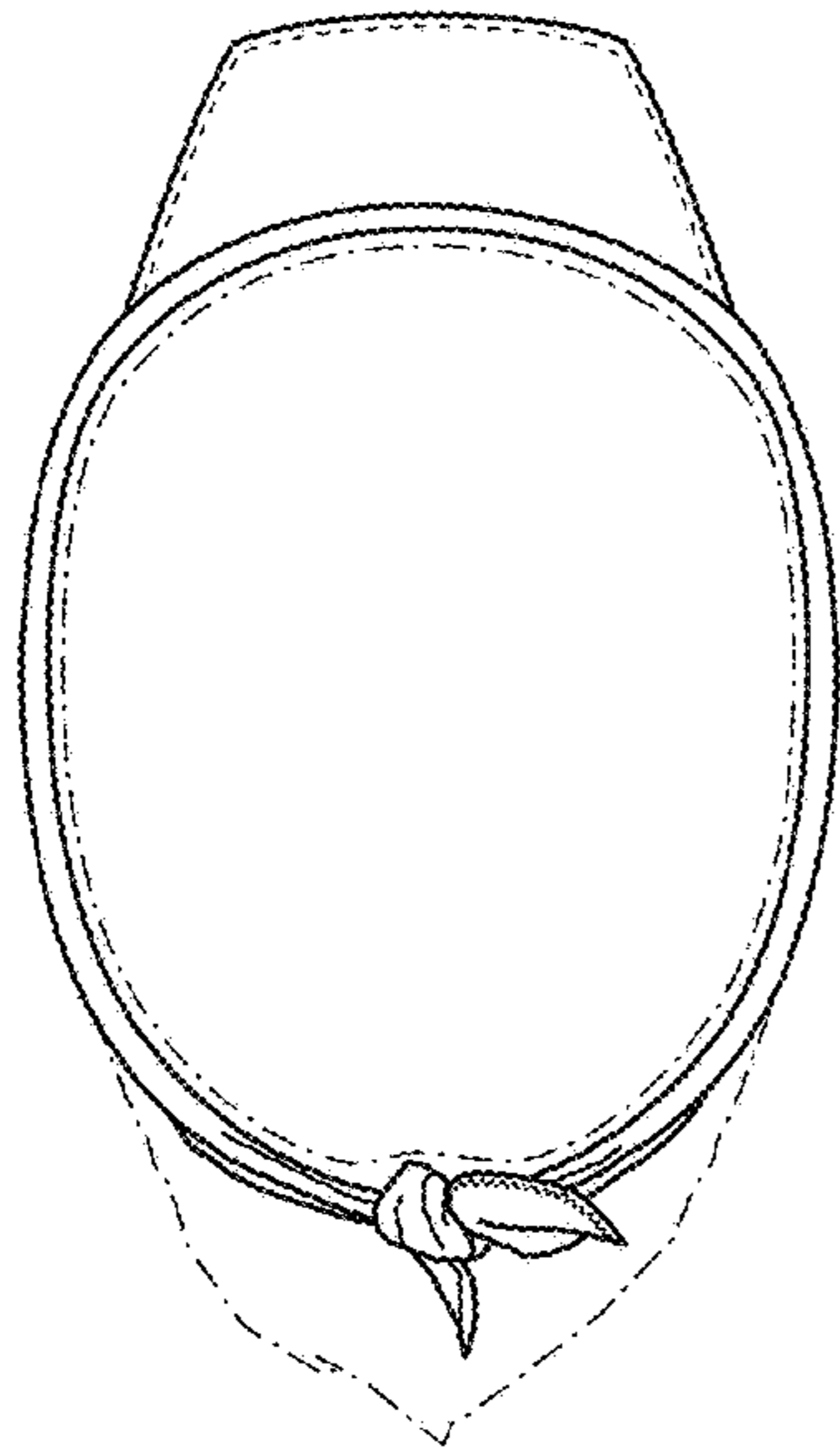

FIG. 4

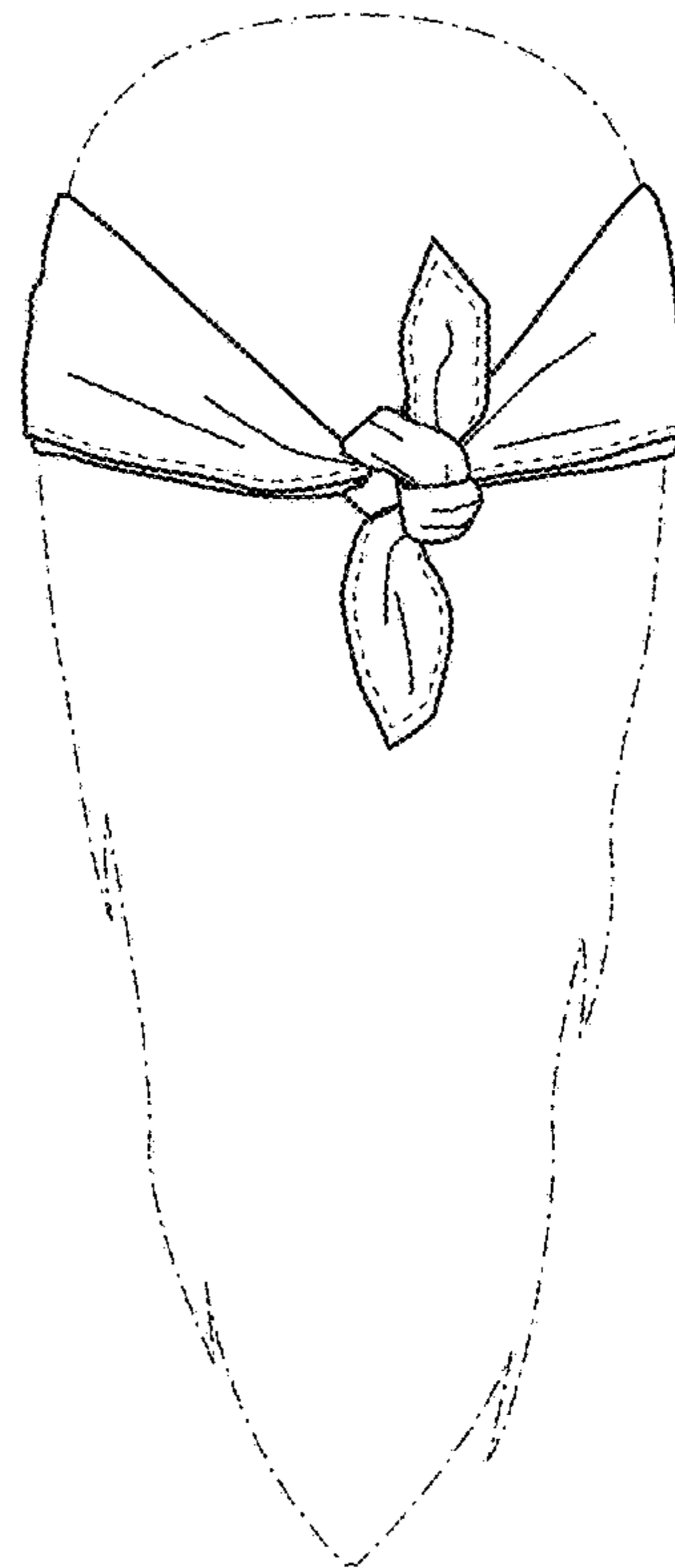

FIG. 5



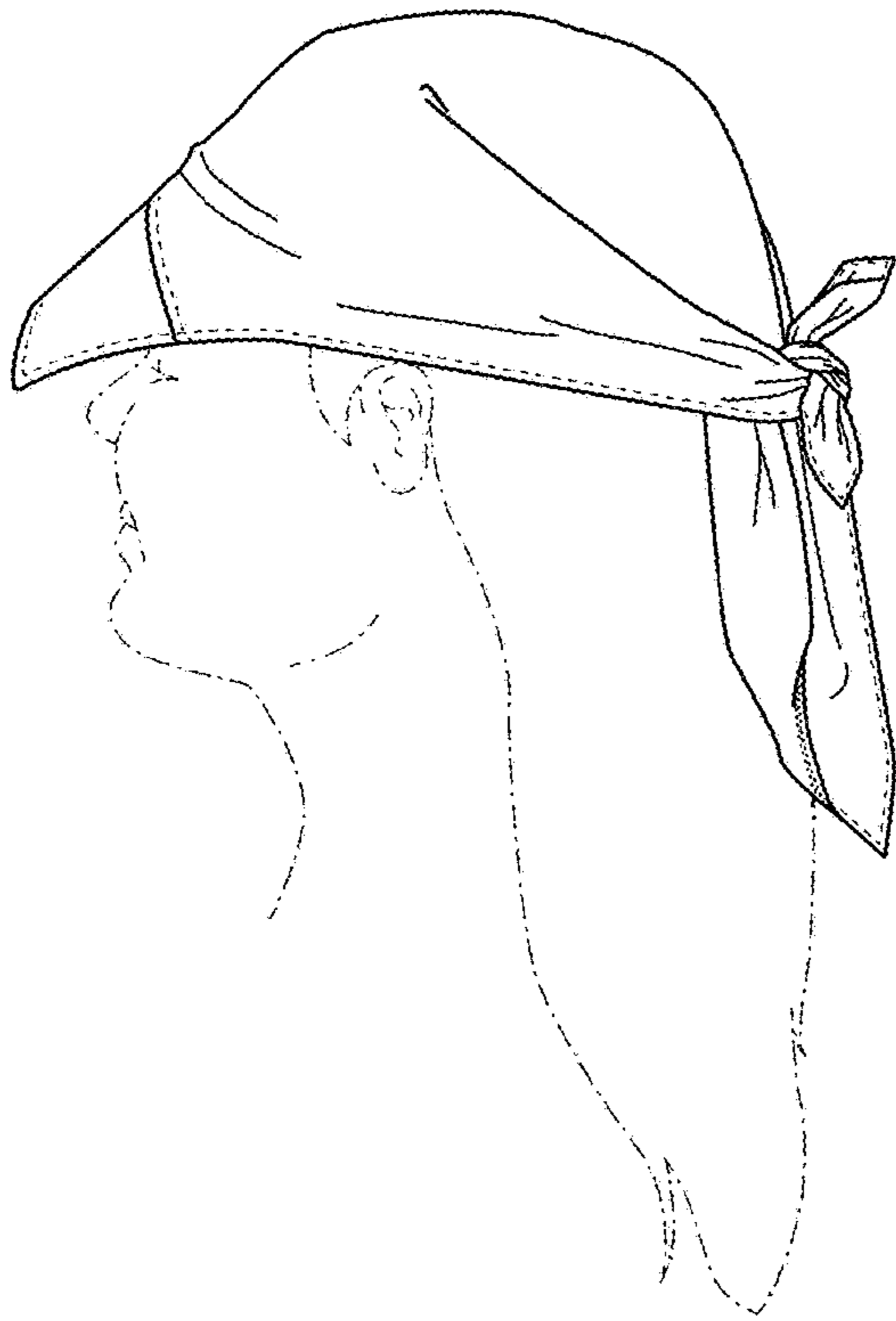

FIG. 6

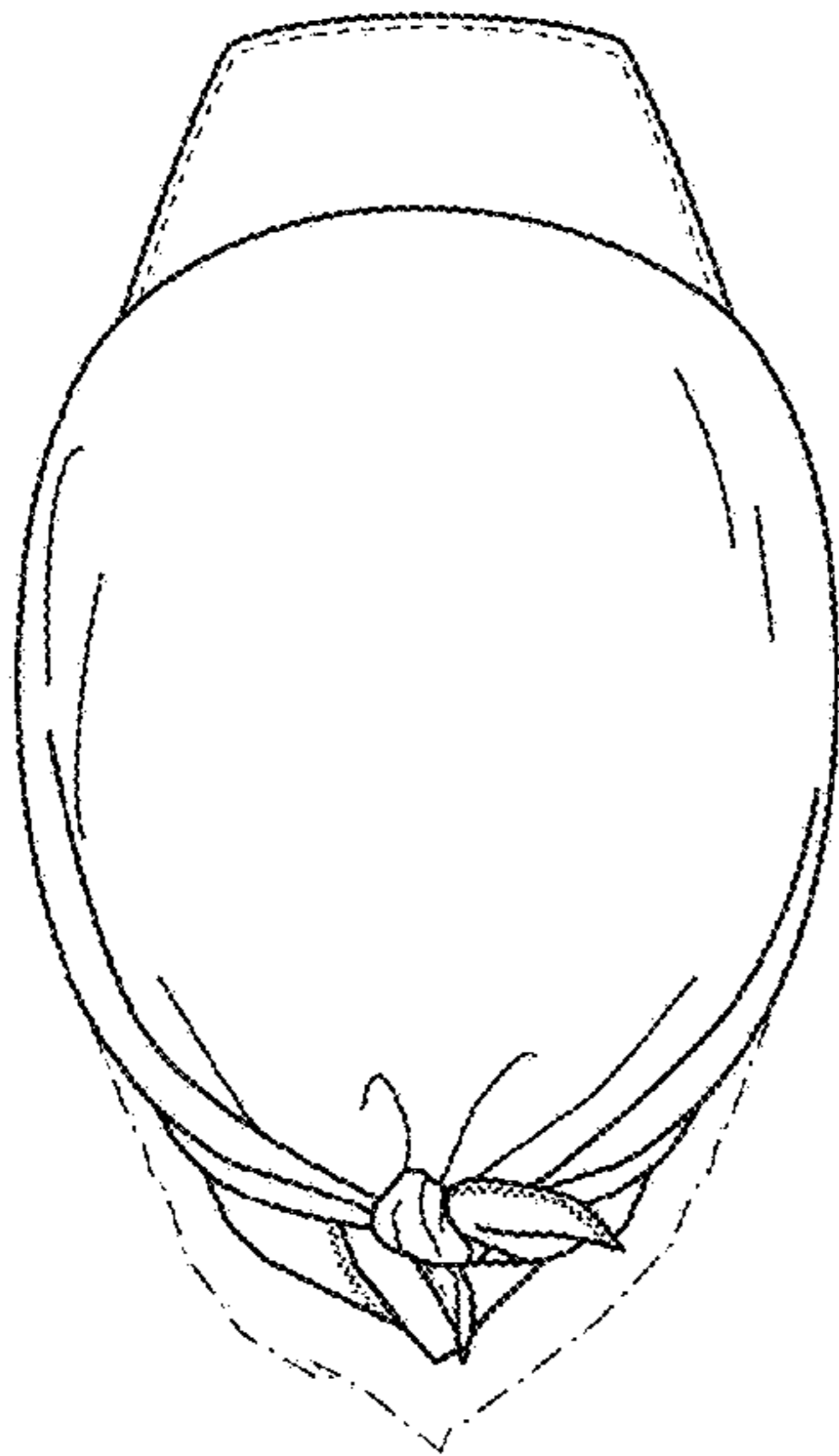

FIG. 7

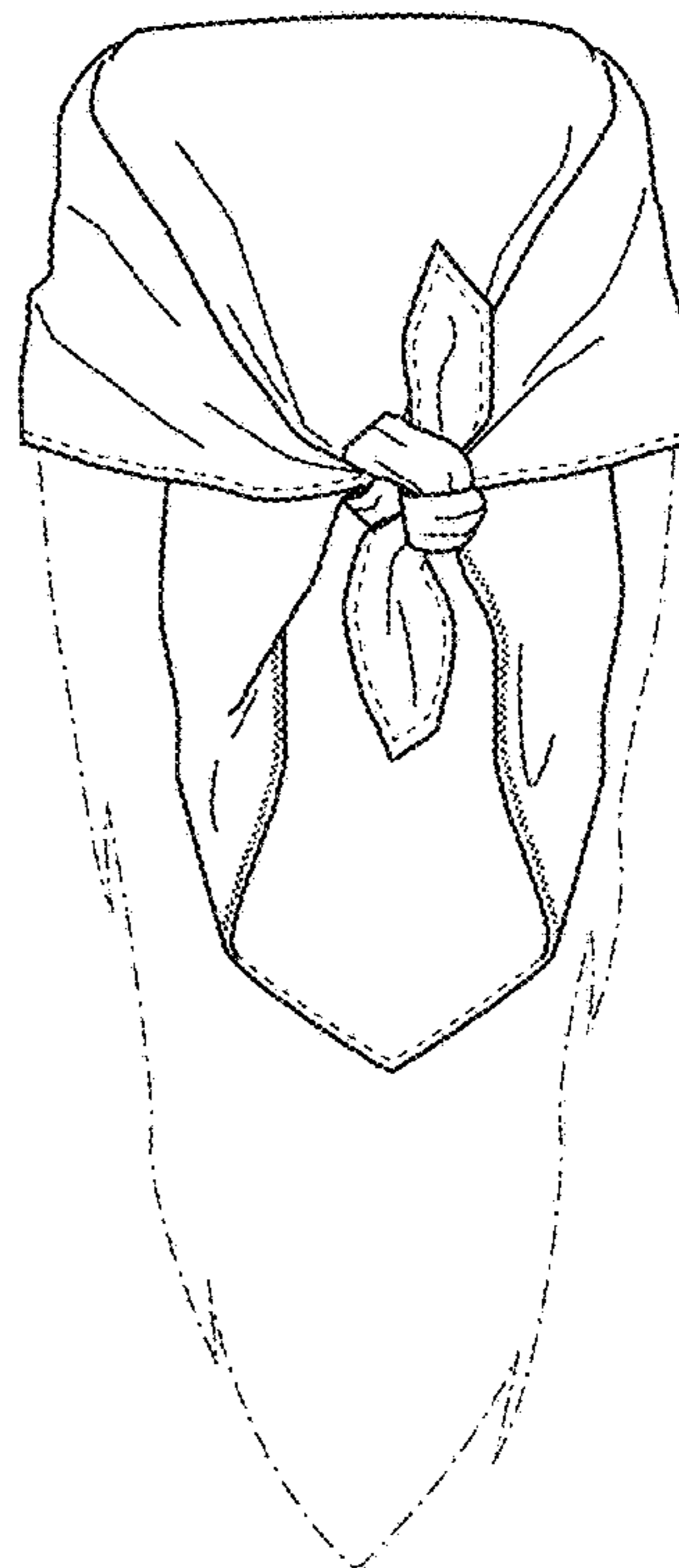

FIG. 8

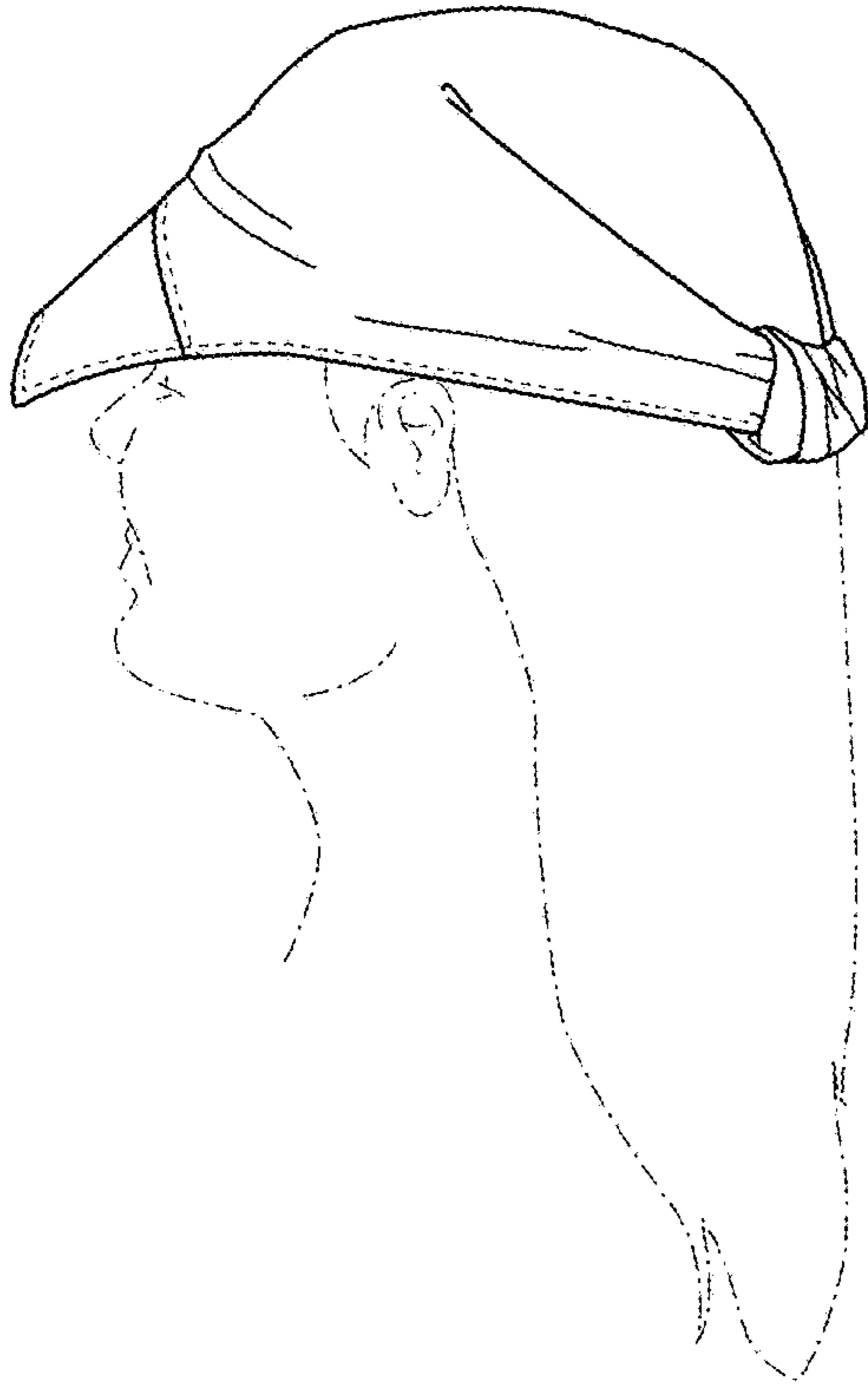

FIG. 9

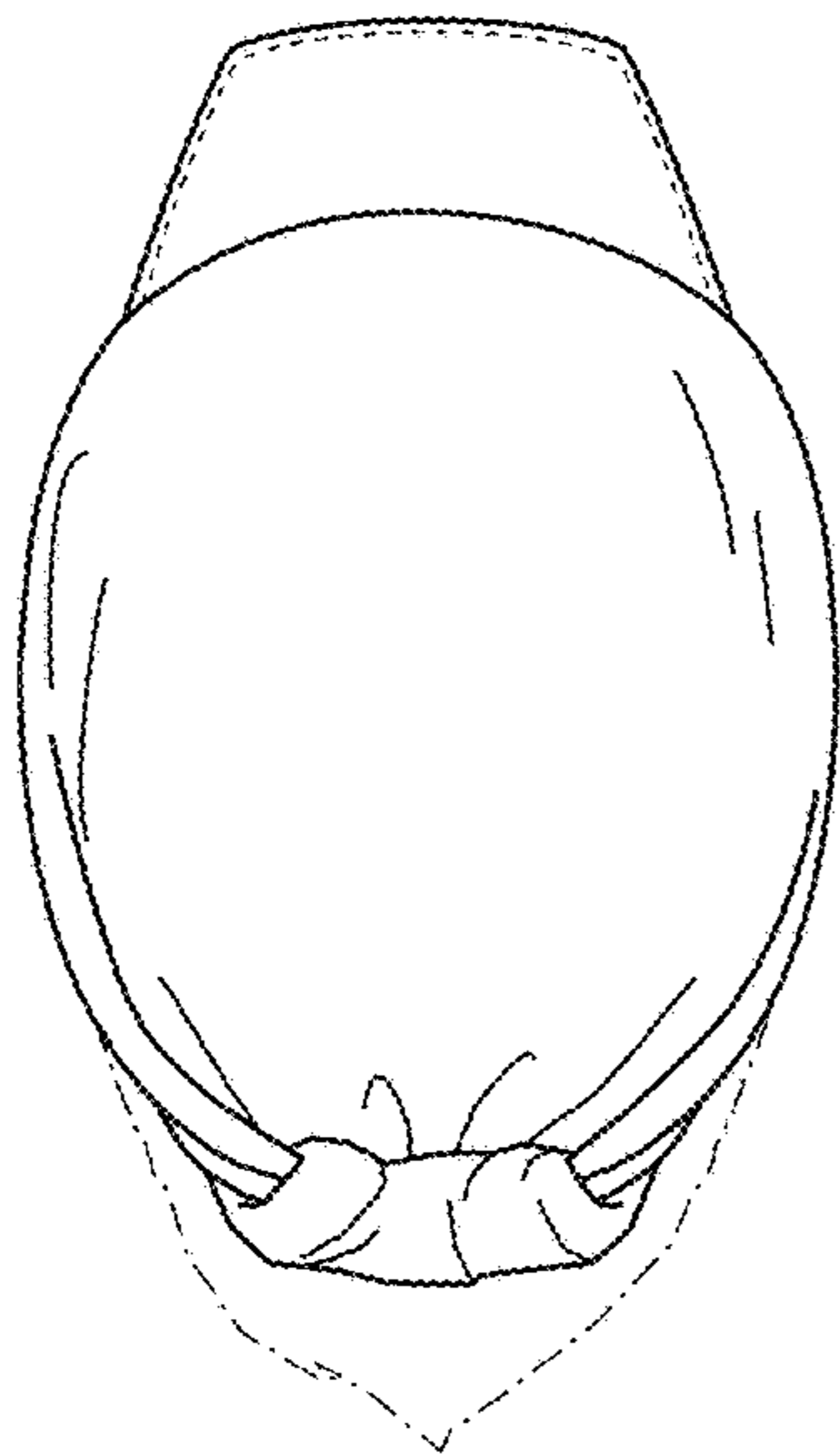

FIG. 10

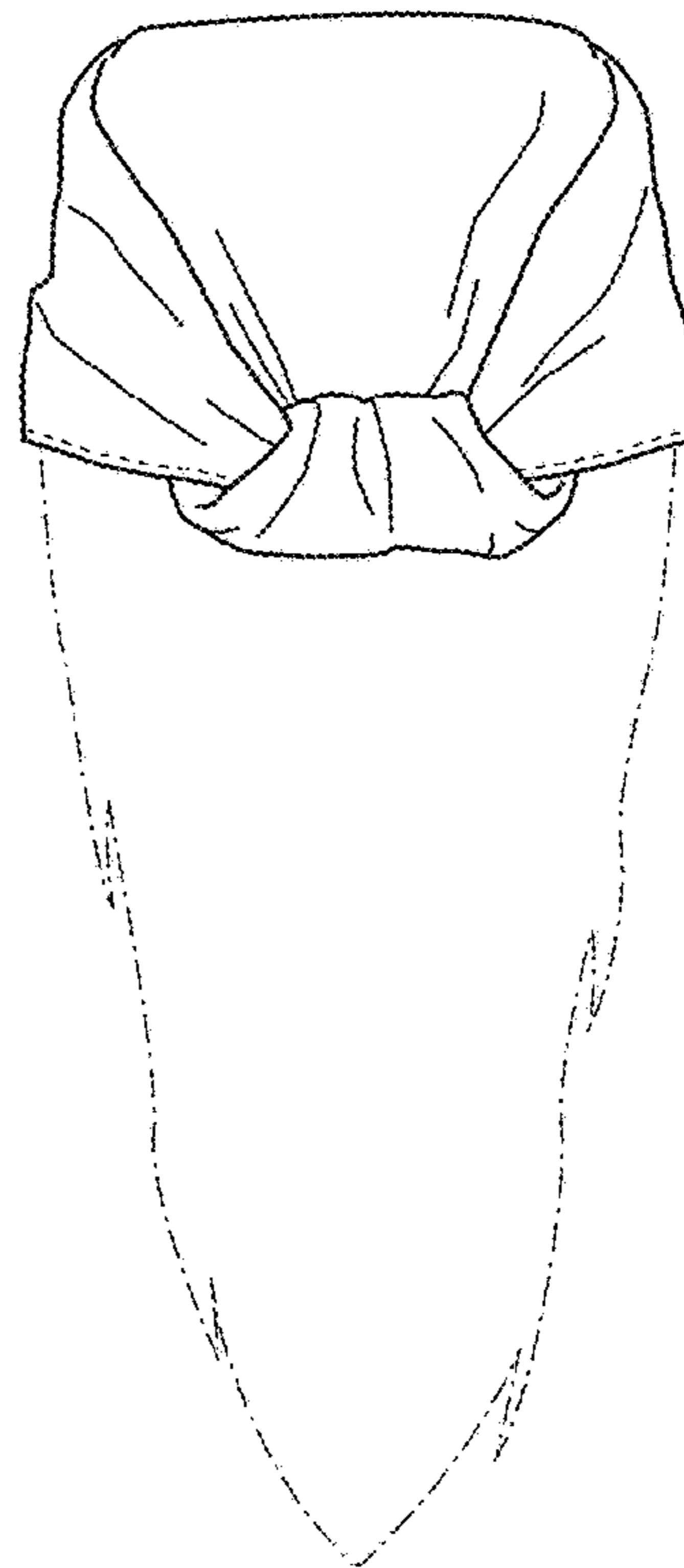

FIG. 11

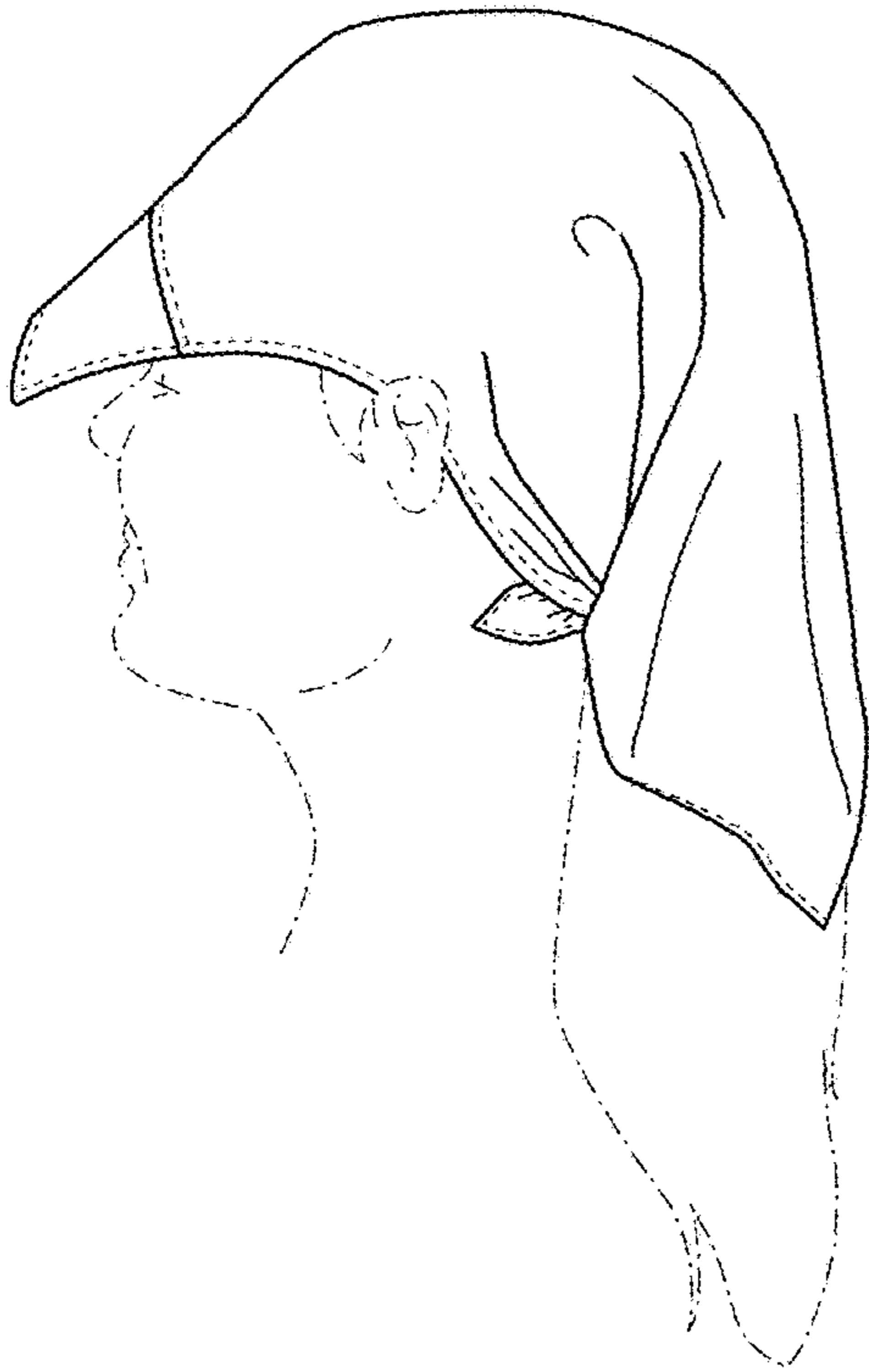

FIG. 12

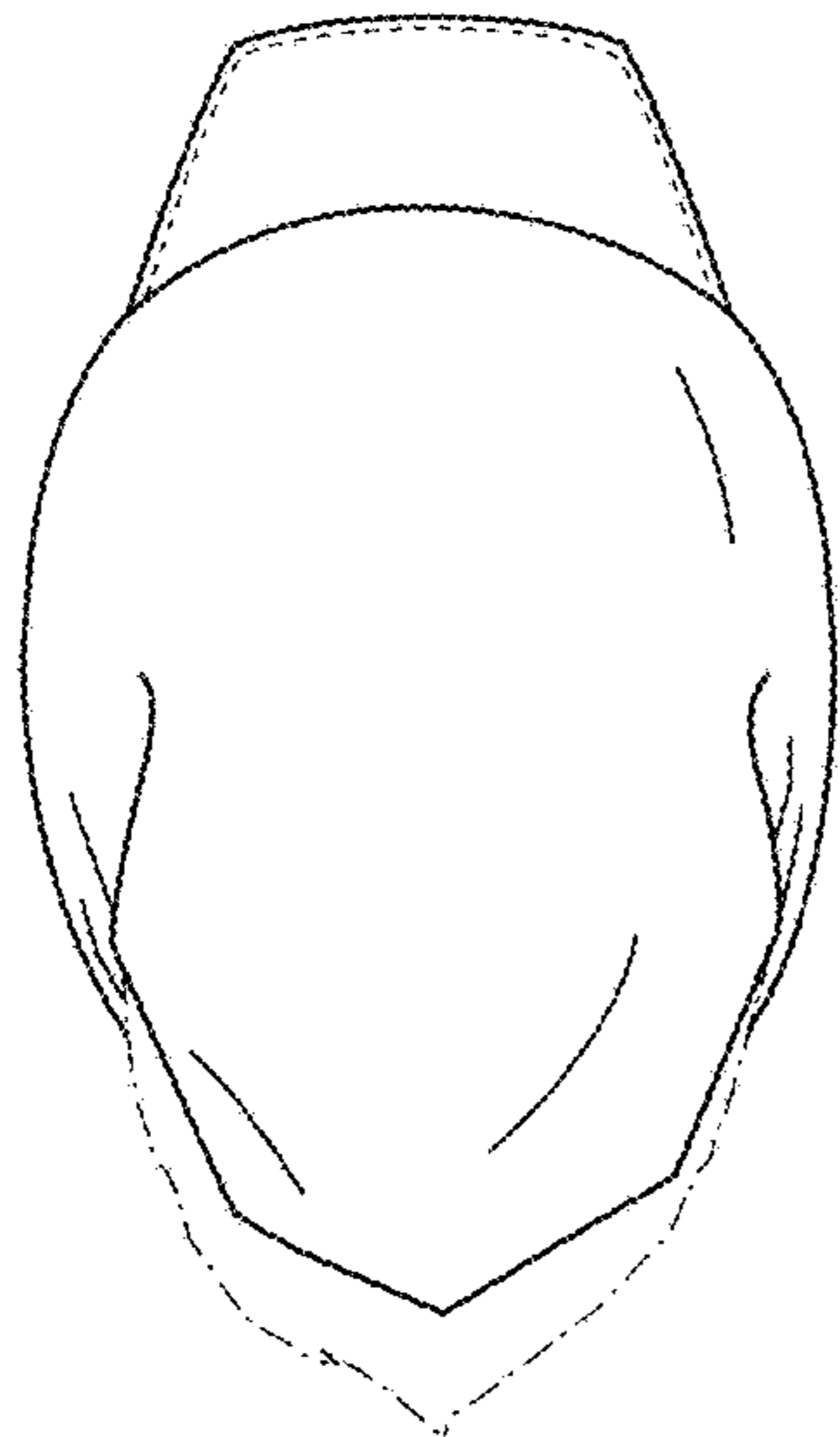

FIG. 13

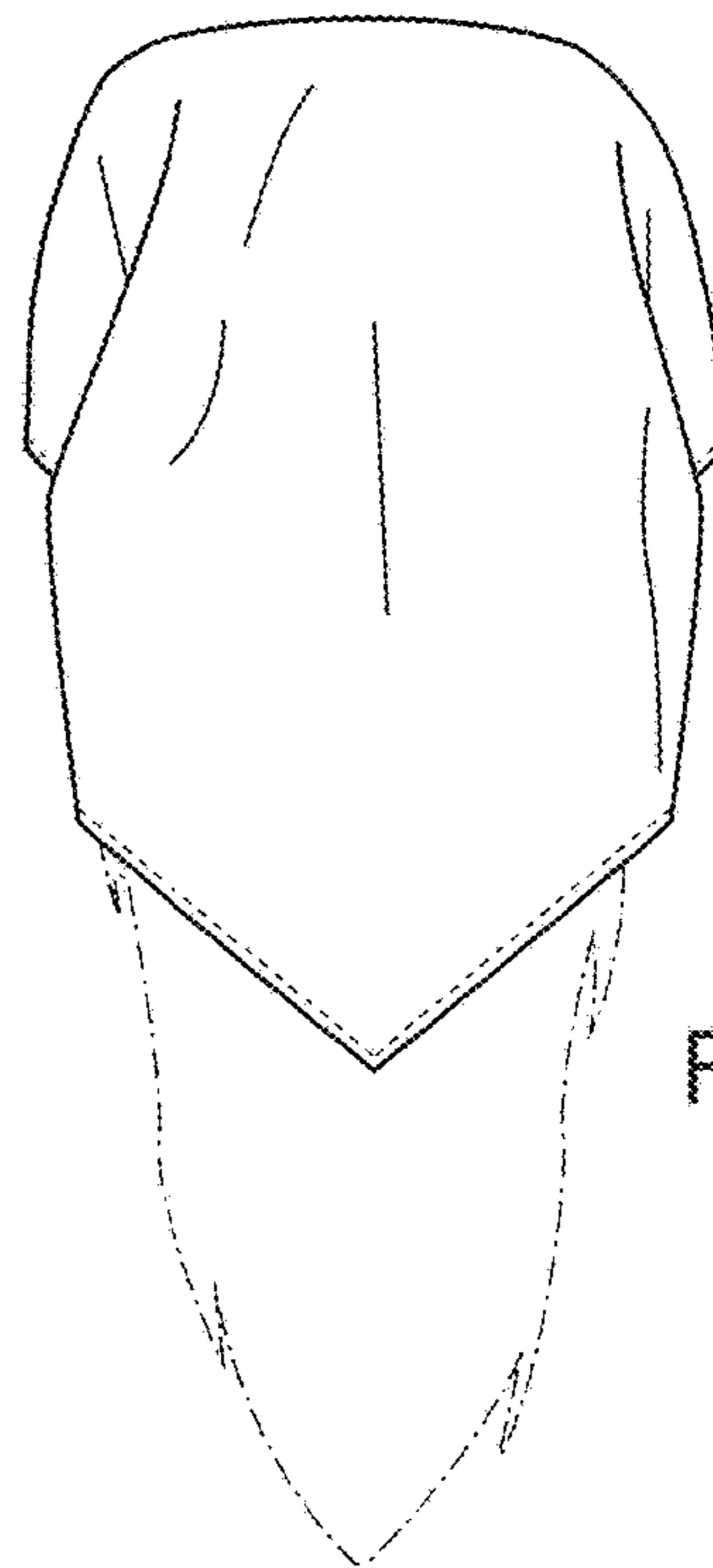

FIG. 14