



US00D834770S

(12) **United States Design Patent**  
**Theno**

(10) **Patent No.:** **US D834,770 S**

(45) **Date of Patent:** **\*\* Nov. 27, 2018**

(54) **PET DEVICE**

(71) Applicant: **Bioesse Technologies, LLC**,  
Minnetonka, MN (US)

(72) Inventor: **Mark H Theno**, Minnetonka, MN (US)

(73) Assignee: **Bioesse Technologies, LLC**,  
Minnetonka, MN (US)

(\*\*) Term: **15 Years**

(21) Appl. No.: **29/603,785**

(22) Filed: **May 12, 2017**

(51) **LOC (11) Cl.** ..... **30-03**

(52) **U.S. Cl.**  
USPC ..... **D30/199; D30/155**

(58) **Field of Classification Search**  
USPC ..... D30/155, 152, 153, 199; 119/865, 655,  
119/51.02, 857-860, 719-721, 792, 795,  
119/602; D11/7, 79, 95, 97, 99,  
D11/107-108, 82, 137, 117-136, 157,  
D11/158, 160, 162, 164, 105, 200, 212,  
D11/218, 80; D2/976, 639, 857; D8/1,  
D8/34, 38, 18; D10/33, 104.1, 104.2;  
D7/619.2; D20/22-32, 10, 43;  
D3/207-212, 270-271.3, 201, 328, 215,  
D3/247, 248, 203.3, 323, 318; D26/38;  
D6/302-304, 634; D24/199, 231;  
D21/610, 611, 626; 40/310, 665,  
40/300-303, 633, 299.01, 323, 649-651,  
40/654.01, 661, 661.11-671, 1, 1.5, 1.6,  
40/124.06, 209, 642.02, 634, 775, 776;  
239/57, 36, 34, 55, 35, 47, 51.5, 56, 60;  
362/812; 206/37.1, 38.1, 0.8, 0.81, 0.815,  
206/0.82, 38, 6.1, 301, 307, 308.1, 477,  
206/483, 493, 37, 527, 449; 70/456 R,  
70/456 B, 458, 459, 457; 24/3.6; 63/40;  
D9/424, 422, 757, 707; D17/20;  
607/115; D28/77, 5, 6; 383/16, 901,  
383/109, 7, 36, 96, 105, 110, 119;

392/386, 383, 392-395, 403, 404;  
261/DIG. 88, DIG. 89, DIG. 17, DIG. 42,  
261/DIG. 47, DIG. 55, DIG. 65, DIG. 70;  
128/204.13, 204.14; D23/360, 355,  
D23/361-364, 366, 367, 369, 385, 386,  
D23/388, 499; 222/175; 455/418;  
422/124; D14/215, 192, 167, 216, 203.6,  
D14/496, 137

(Continued)

(56) **References Cited**

U.S. PATENT DOCUMENTS

D255,264 S \* 6/1980 Butcher ..... D23/367  
D255,265 S \* 6/1980 Butcher ..... D23/367

(Continued)

*Primary Examiner* — Susan Moon Lee

(74) *Attorney, Agent, or Firm* — Schwegman Lundberg &  
Woessner, P.A.

(57) **CLAIM**

The ornamental design for a pet device, as shown and  
described.

**DESCRIPTION**

FIG. 1 is a perspective view of an embodiment of a pet  
device according to my design;  
FIG. 2 is front elevational view thereof;  
FIG. 3 is a rear elevational view thereof;  
FIG. 4 is a right side elevational view thereof;  
FIG. 5 is a left side elevational view thereof;  
FIG. 6 is a top plan view thereof; and,  
FIG. 7 is a bottom plan view thereof.  
Broken lines having repeated short dashes in the figures are  
for illustrative purposes only and form no part of the claimed  
design. Shade lines having a combination of long and short  
lines in the figures show contour and not surface ornamen-  
tation.

**1 Claim, 6 Drawing Sheets**

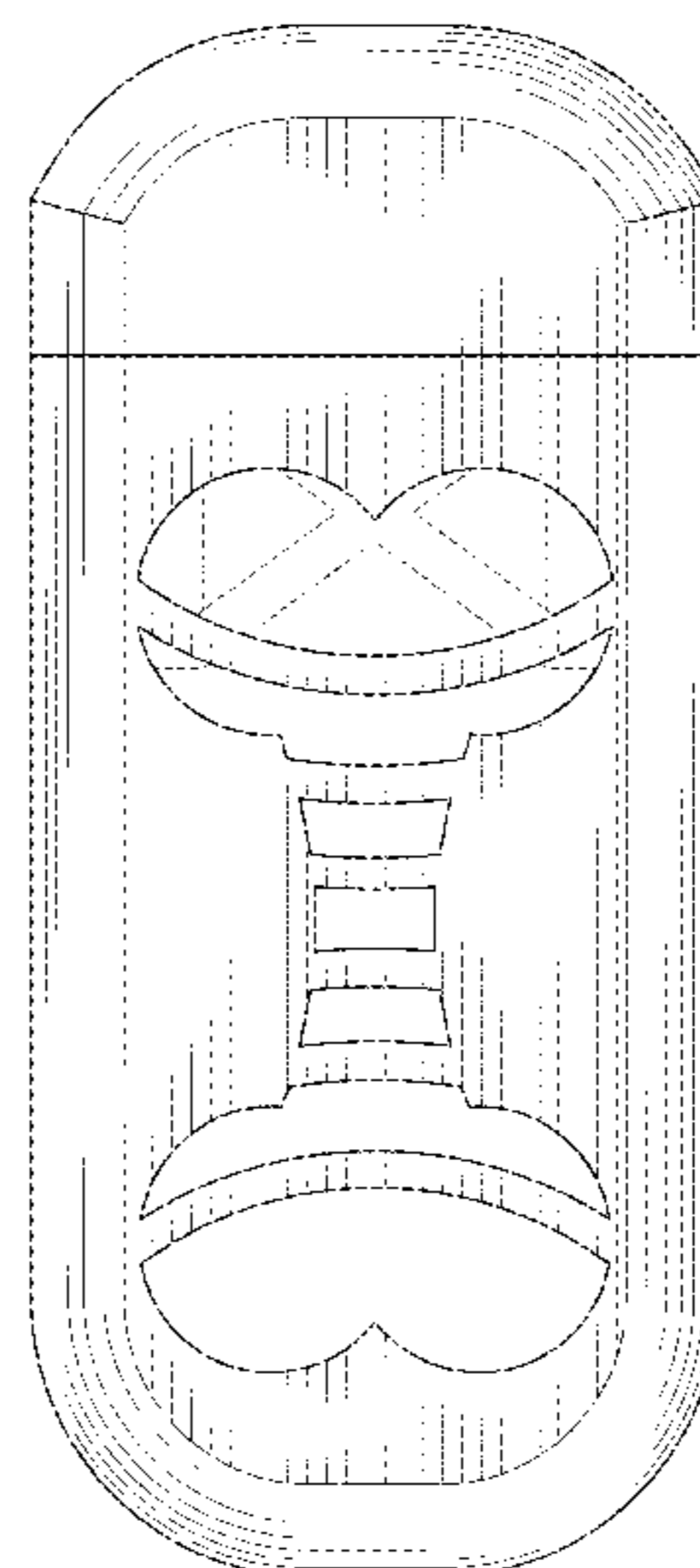
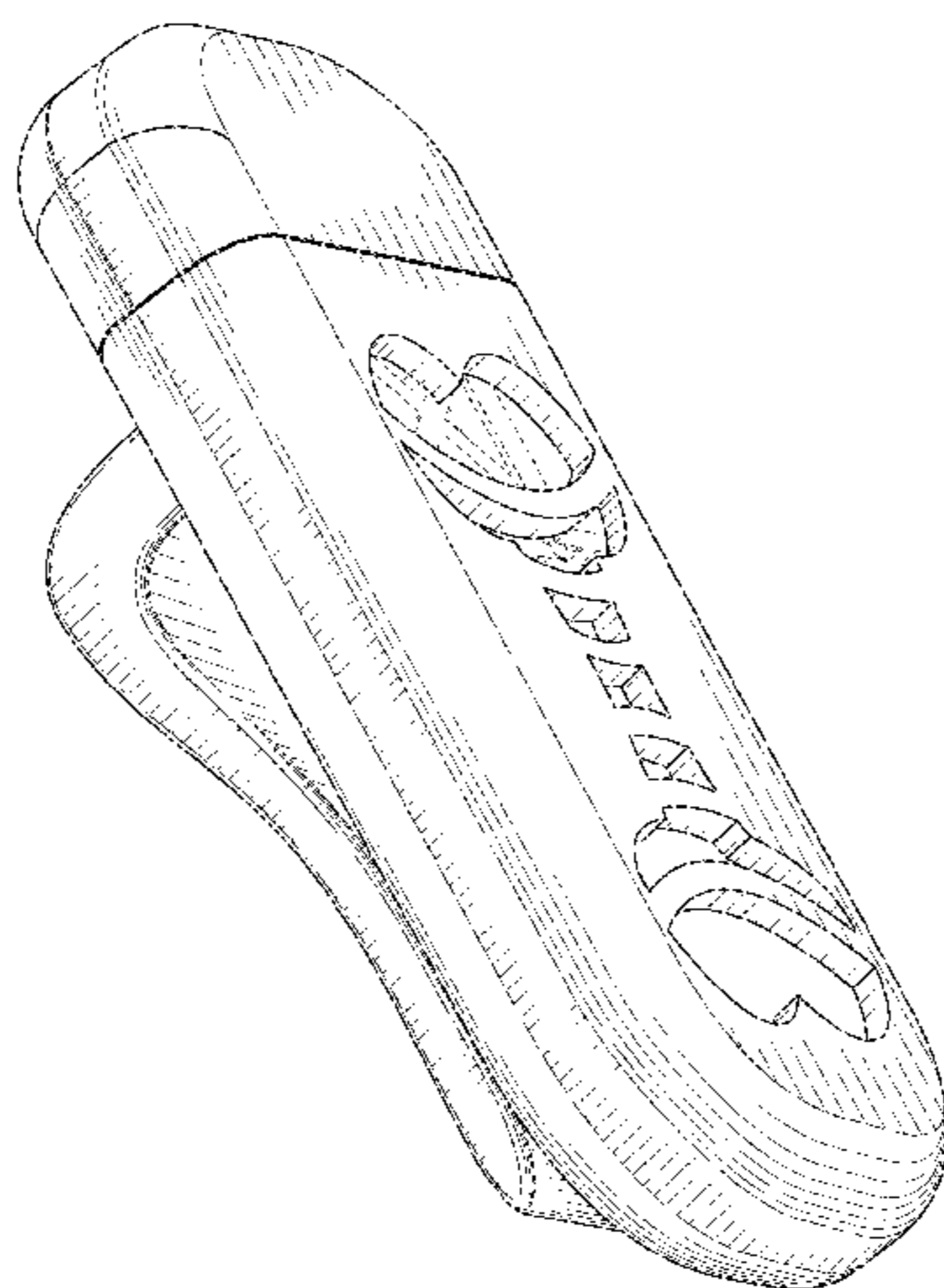

(58) **Field of Classification Search**

CPC .... A01K 11/00-11/004; A01K 27/00-27/009;  
 A01K 29/00; A01K 29/005; A01K  
 13/003; G09F 3/185; G09F 3/18; G09F  
 3/20; G09F 3/201-3/207; A44C  
 3/00-3/008; A44C 15/0025; A44C  
 15/005; A44C 25/00-25/004; A44C  
 25/007; A44C 25/008; A44C 27/002;  
 A44C 27/003; A47G 33/08; A47G  
 33/0809; A47G 2033/0827; B44C 5/00;  
 B44C 5/02; B44C 5/06; B44C 7/00;  
 G10D 3/163; A61F 7/02; A61F 7/0241;  
 A61F 7/08; A61F 7/086; A61F  
 2007/0203; A61F 2007/0215; A61F  
 2007/0219; A61F 2007/022; A61F  
 2007/0222; A61F 2007/0257; A61F  
 2007/0277; A61F 2007/0274; Y10S  
 383/901; B65D 33/2591; B65D 39/08;  
 B29D 22/006; A61L 9/12; A61L 9/042;  
 A61L 9/122; A61L 9/125; A61L 9/127;  
 A61L 9/02; A61L 9/037; A61L 9/04;  
 A61L 9/048; A61L 9/22; A61L  
 2209/11-2209/13; A61L 2209/15; A61L  
 2209/131; A61L 2209/133; A61M 21/02;  
 A61M 2021/0016; A61M 2209/088;  
 A61M 2250/00; A01M 1/2044; A01M  
 1/2033

See application file for complete search history.

(56) **References Cited**

U.S. PATENT DOCUMENTS

4,258,874 A \* 3/1981 Webinger ..... A61L 9/12  
 229/120  
 4,339,079 A \* 7/1982 Sato ..... A45D 34/00  
 239/43  
 D299,054 S \* 12/1988 Brun ..... D23/368  
 4,849,606 A \* 7/1989 Martens, III ..... B65D 77/2024  
 392/390  
 D313,274 S \* 12/1990 Peterson ..... D23/369  
 D330,414 S \* 10/1992 Creswell ..... D23/368  
 D332,999 S \* 2/1993 Hoyt ..... D23/367  
 5,422,078 A \* 6/1995 Colon ..... A61L 9/12  
 239/54  
 5,478,505 A \* 12/1995 McElfresh ..... A61L 9/122  
 239/57

D382,050 S \* 8/1997 Hayes ..... D23/366  
 D384,408 S \* 9/1997 Foreman ..... D23/366  
 D385,025 S \* 10/1997 Ho ..... D23/366  
 5,899,382 A \* 5/1999 Hayes ..... A61L 9/12  
 239/56  
 D439,964 S \* 4/2001 Wu ..... D23/366  
 D450,112 S \* 11/2001 Longley ..... D23/368  
 D472,968 S \* 4/2003 Christianson ..... D23/364  
 6,610,254 B1 \* 8/2003 Furner ..... A01M 1/2033  
 222/183  
 D485,340 S \* 1/2004 Wu ..... D23/366  
 D503,974 S \* 4/2005 Morillas ..... D23/366  
 D505,479 S \* 5/2005 Burgeson ..... D22/125  
 D519,624 S \* 4/2006 Chen ..... D23/368  
 D528,643 S \* 9/2006 Wang ..... D23/364  
 D532,893 S \* 11/2006 Wu ..... D23/366  
 D550,828 S \* 9/2007 Wu ..... D23/366  
 D555,358 S \* 11/2007 King ..... D3/293  
 D557,785 S \* 12/2007 Wu ..... D23/366  
 D591,415 S \* 4/2009 Wu ..... D23/366  
 D607,983 S \* 1/2010 Irvin ..... D23/366  
 D610,666 S \* 2/2010 Furner ..... D23/366  
 D614,528 S \* 4/2010 Johnson ..... D11/103  
 D633,610 S \* 3/2011 Wu ..... D23/366  
 D642,668 S \* 8/2011 Lablaine ..... D23/366  
 D647,186 S \* 10/2011 Chan ..... D23/364  
 D663,401 S \* 7/2012 Hewson-Hyde ..... D23/366  
 D672,031 S \* 12/2012 Hunt ..... D24/106  
 D674,886 S \* 1/2013 Irwin ..... D23/366  
 D721,428 S \* 1/2015 Donovan ..... D23/368  
 D789,364 S \* 6/2017 Jentz ..... D14/218  
 D789,365 S \* 6/2017 Jentz ..... D14/218  
 D799,353 S \* 10/2017 Qu ..... D10/104.2  
 D807,215 S \* 1/2018 Martin ..... D10/104.1  
 9,968,702 B2 \* 5/2018 Torres ..... A61L 9/12  
 2004/0016818 A1 \* 1/2004 Murdell ..... A01M 1/2033  
 239/34  
 2007/0057086 A1 \* 3/2007 Van Kippersluis ..... A61L 9/04  
 239/43  
 2007/0290064 A1 \* 12/2007 Majerowski ..... A01M 1/2044  
 239/44  
 2008/0095522 A1 \* 4/2008 Deflorian ..... A61L 9/03  
 392/387  
 2009/0008411 A1 \* 1/2009 Schumacher ..... A01M 1/2033  
 222/175  
 2010/0187327 A1 \* 7/2010 Irvin ..... A61L 9/125  
 239/47  
 2010/0288847 A1 \* 11/2010 Gruenbacher ..... A01M 1/2033  
 239/34

\* cited by examiner

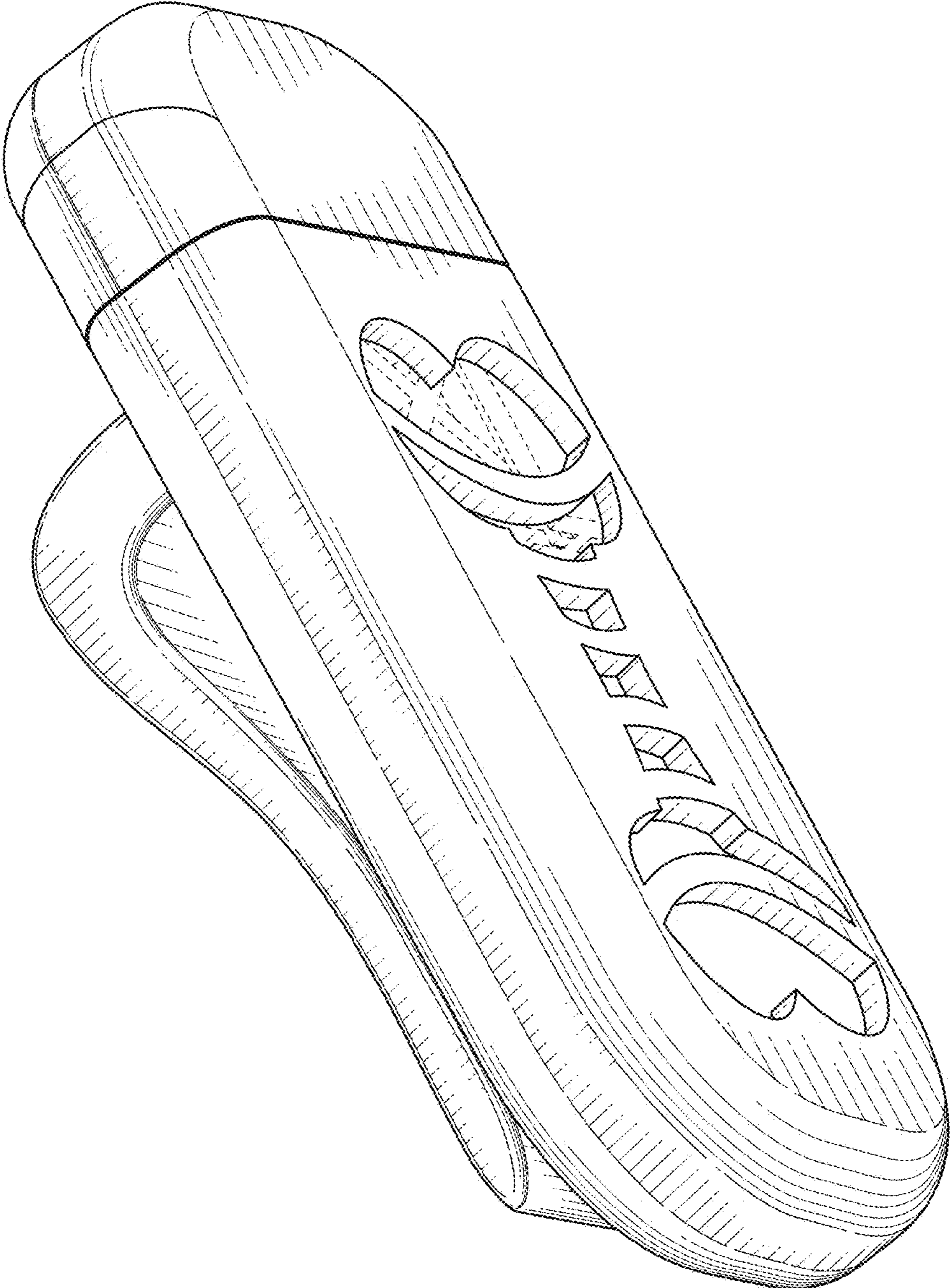

FIG. 1

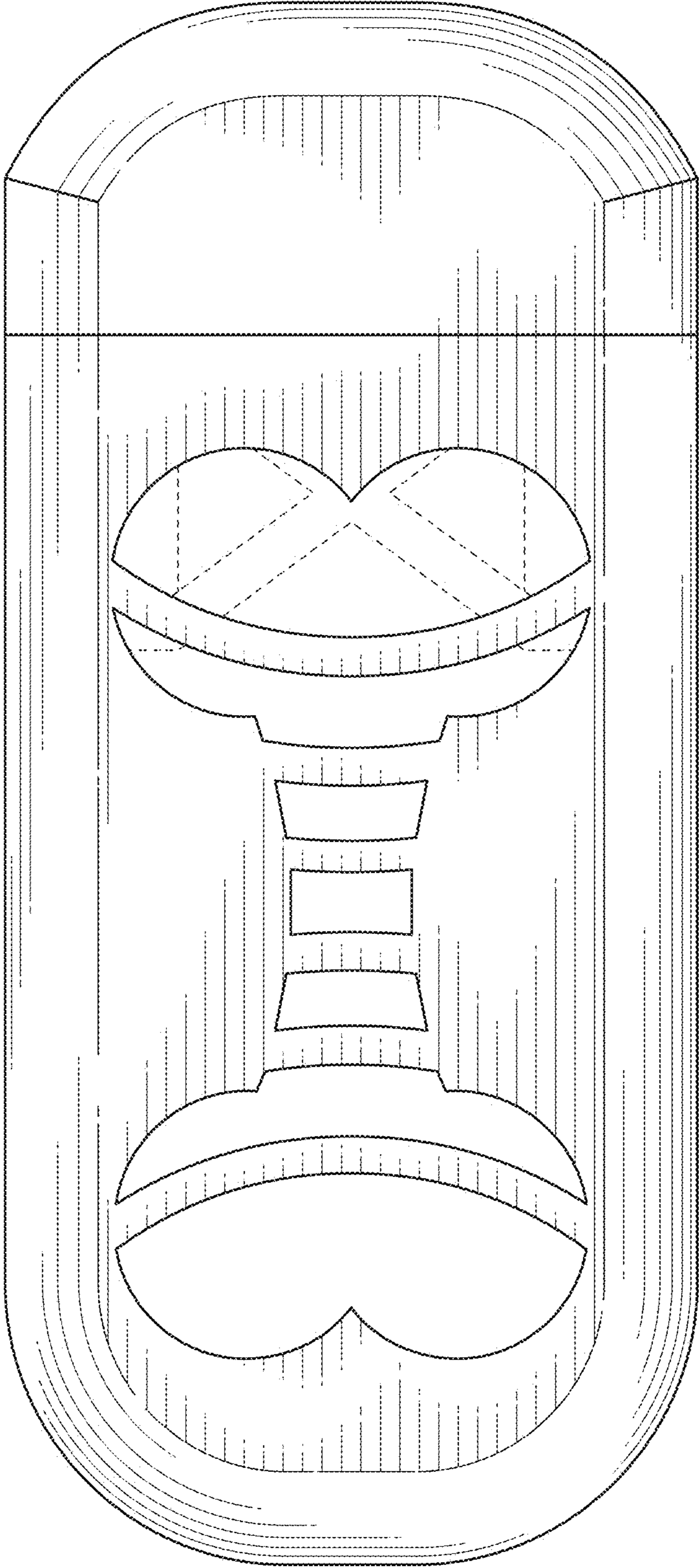

FIG. 2

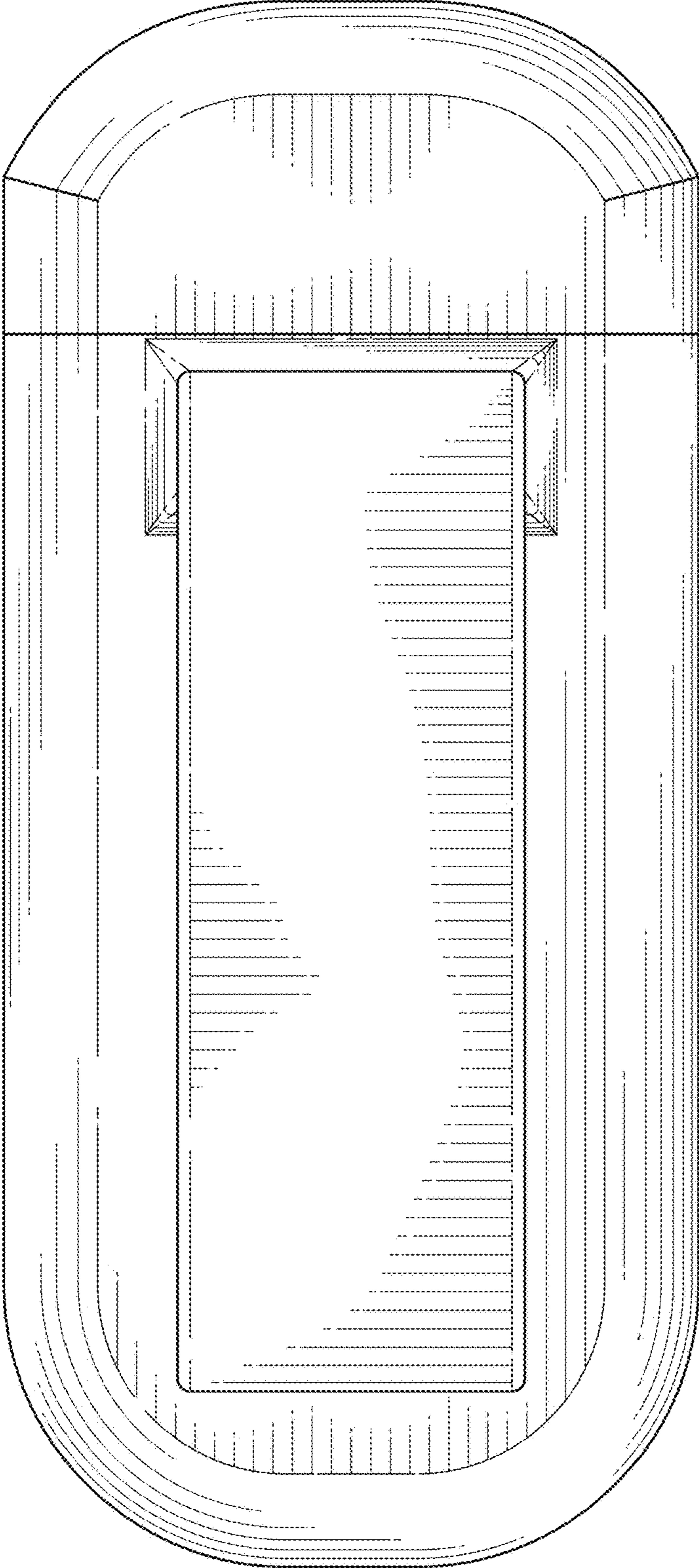

FIG. 3

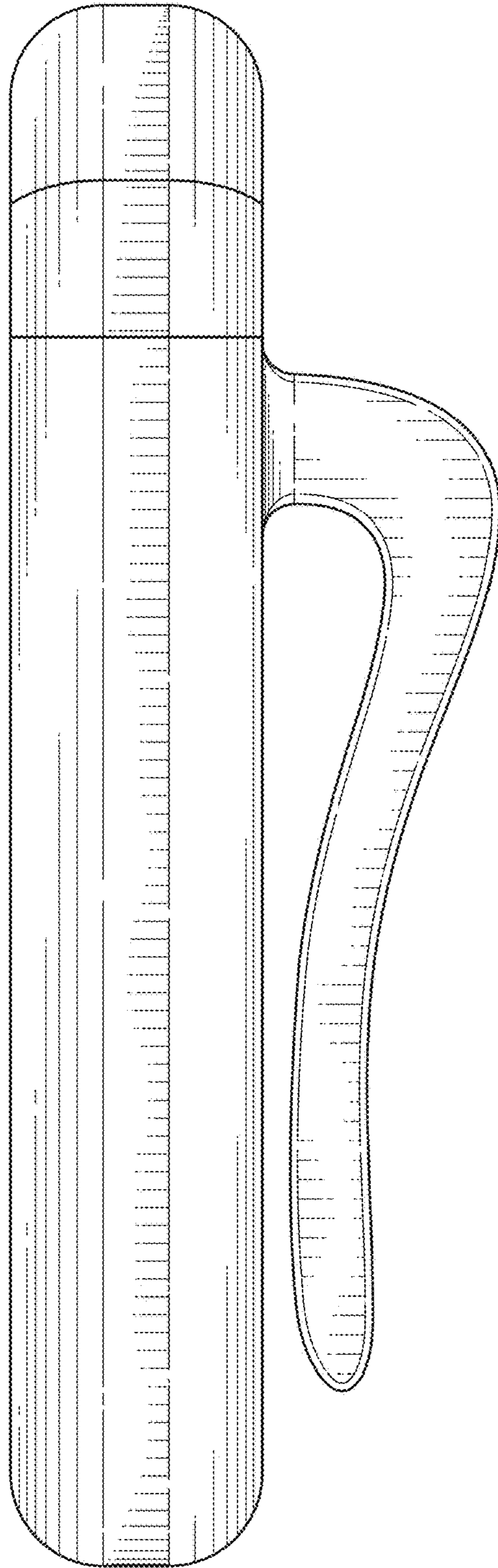

FIG. 4

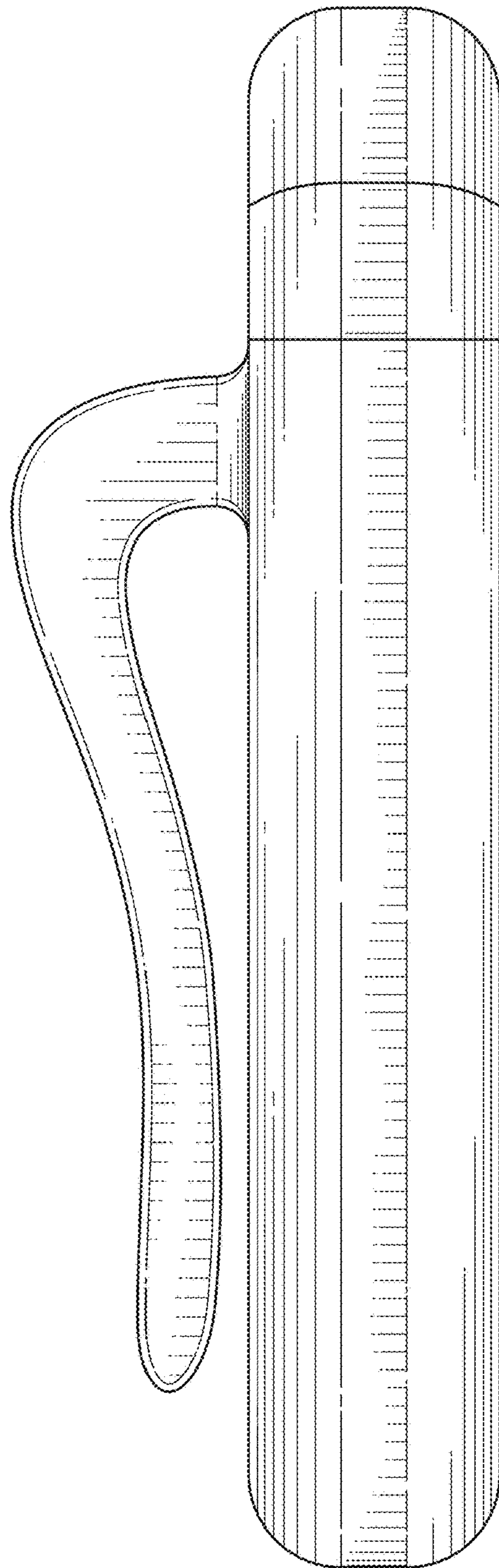

FIG. 5

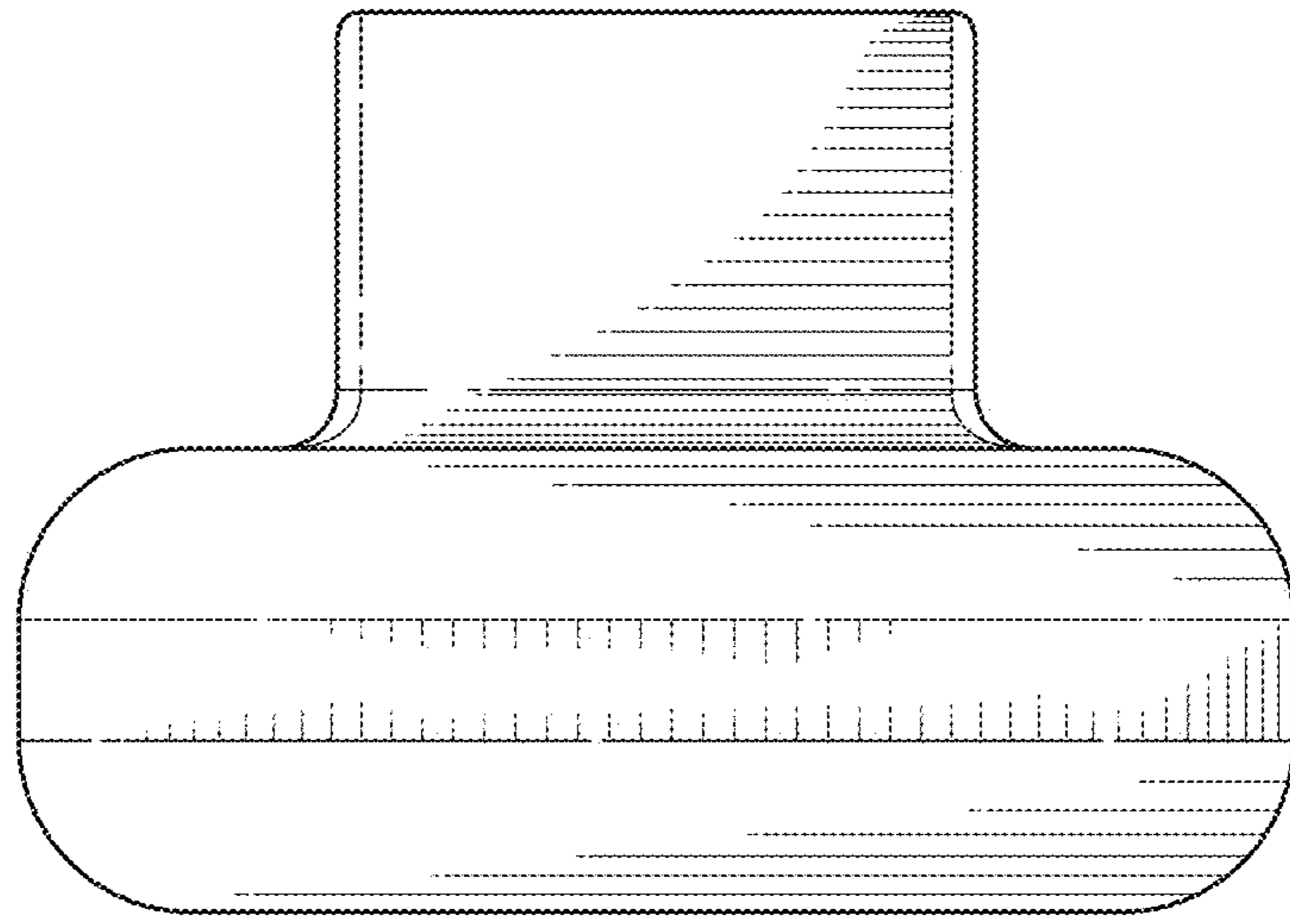

FIG. 6

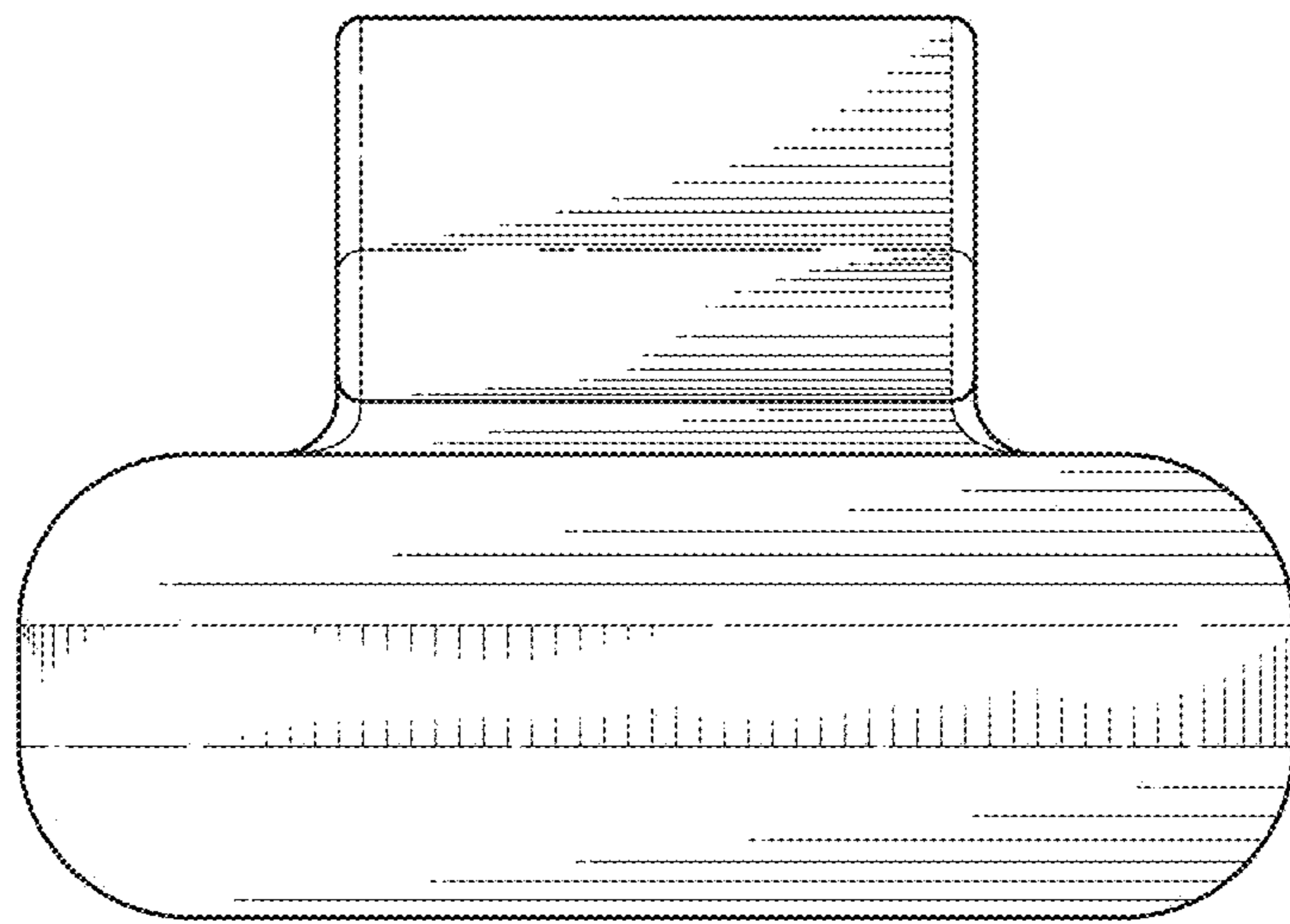

FIG. 7