



US00D834548S

(12) **United States Design Patent** (10) **Patent No.:** **US D834,548 S**
Vinciarelli et al. (45) **Date of Patent:** **** Nov. 27, 2018**

- (54) **ELECTRIC TERMINAL**
- (71) Applicant: **VLT, Inc.**, Sunnyvale, CA (US)
- (72) Inventors: **Patrizio Vinciarelli**, Boston, MA (US);
Michael B. LaFleur, East Hampstead, NH (US)
- (73) Assignee: **VLT, Inc.**, Sunnyvale, CA (US)
- (**) Term: **15 Years**
- (21) Appl. No.: **29/614,894**
- (22) Filed: **Aug. 24, 2017**

- 5,066,999 A 11/1991 Casper
 - 5,742,005 A 4/1998 Saka et al.
 - 5,757,082 A 5/1998 Shibata
 - 5,994,772 A 11/1999 Shin
 - 6,078,505 A 6/2000 Turudic
 - 6,348,742 B1 2/2002 MacPherson
 - 6,391,681 B1 * 5/2002 Corisis H01L 23/49838
257/E21.508
 - D466,093 S 11/2002 Ebihara et al.
 - 6,476,505 B2 11/2002 Nakamura
 - 6,483,038 B2 11/2002 Lee et al.
- (Continued)

Related U.S. Application Data

- (62) Division of application No. 29/556,621, filed on Mar. 2, 2016, now Pat. No. Des. 798,249, which is a division of application No. 29/470,060, filed on Oct. 17, 2013, now Pat. No. Des. 754,083.
- (51) **LOC (11) Cl.** **13-03**
- (52) **U.S. Cl.**
USPC **D13/182**
- (58) **Field of Classification Search**
USPC D13/182; 257/678, 690; 361/679.31,
361/719, 720, 752, 777, 820
CPC H01L 21/00; H01L 21/02; H01L 23/3675;
H01L 23/3677; H01L 23/48; H01L
23/481; H01L 23/50; H01L 23/482; H01L
23/52; H01L 23/498; H01L 23/49805;
H01L 23/49811; H05K 7/1422; H05K
7/1424; H05K 7/1427; H05K 7/1428
See application file for complete search history.

(56) **References Cited**

U.S. PATENT DOCUMENTS

- 3,579,046 A 5/1971 Jordan
- 4,338,621 A 7/1982 Braun
- 4,698,663 A 10/1987 Sugimoto et al.
- D317,300 S 6/1991 Hasegawa et al.

OTHER PUBLICATIONS

Mitsubishi Electric Corporation, Release No. 2647, Mitsubishi Electric Launches 1200V/50A Large-Type Dual In-Line Package Intelligent Power Module, Jan. 26, 2012, 2 pages.
(Continued)

Primary Examiner — Elizabeth J Oswecki
(74) *Attorney, Agent, or Firm* — Foley & Lardner LLP

(57) **CLAIM**

The ornamental design for an electric terminal, as shown and described.

DESCRIPTION

FIG. 1 is a top, front, right perspective view of an electric terminal showing our new design;
FIG. 2 is a front elevation view thereof;
FIG. 3 is a rear elevation view thereof;
FIG. 4 is a right side elevation view thereof;
FIG. 5 is a left side elevation view thereof;
FIG. 6 is a top plan view thereof; and,
FIG. 7 is a bottom plan view thereof.
The dashed-dot-dashed lines represent the boundary line of the claimed design. The even dashed broken lines shown in the drawings represent portions of the electric terminal that form no part of the claimed design.

1 Claim, 5 Drawing Sheets

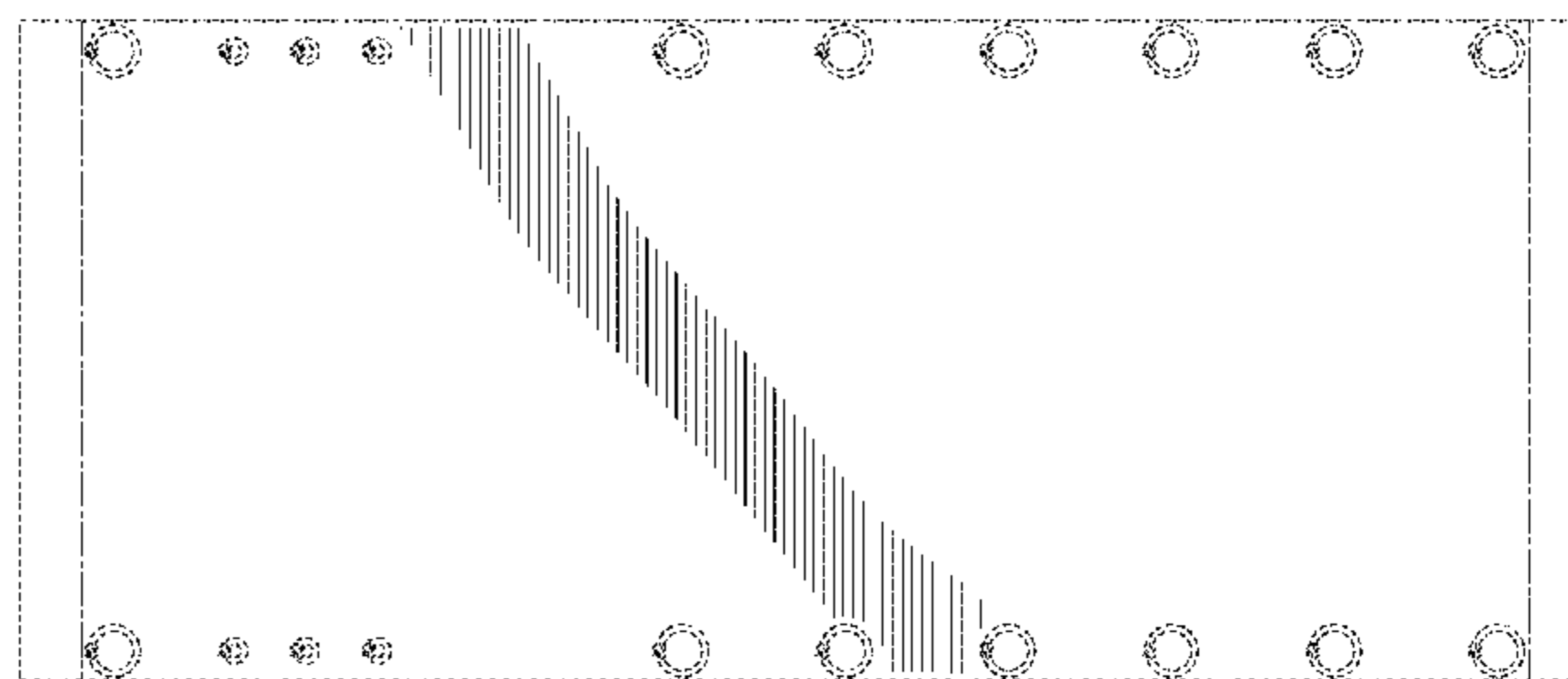
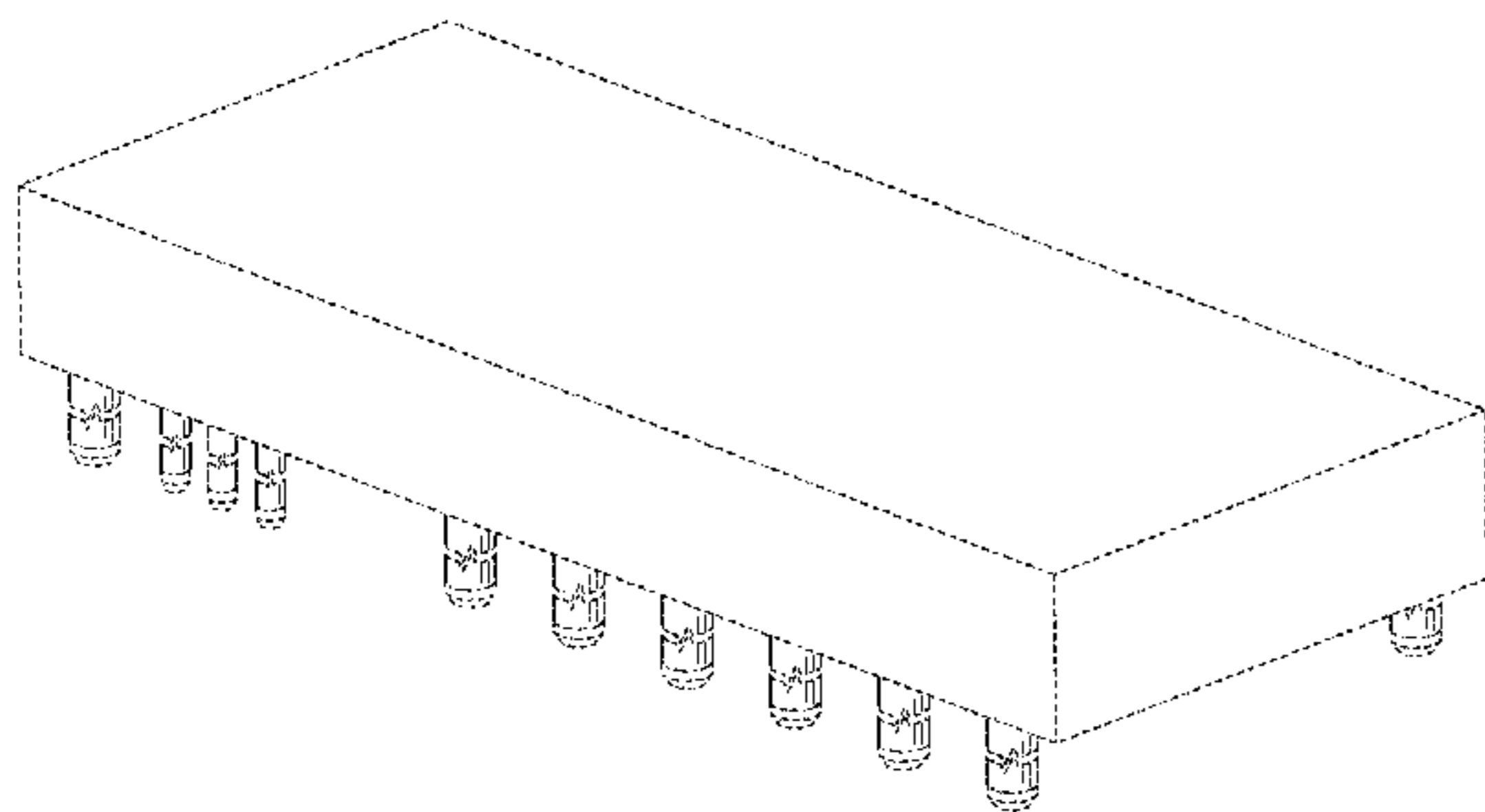

(56)

References Cited

U.S. PATENT DOCUMENTS

6,494,723 B2 * 12/2002 Yamane B60R 16/0238
439/404
D471,167 S 3/2003 Hitoshi et al.
6,537,850 B1 3/2003 Corisis
D485,536 S 1/2004 Dang et al.
6,723,924 B2 * 4/2004 Yuasa H01R 13/17
174/50
6,753,482 B1 6/2004 Schoenfeld et al.
6,905,347 B2 * 6/2005 Kobayashi B60R 16/0239
439/76.2
D540,272 S 4/2007 Higashibata
D547,371 S 7/2007 Miller
D601,520 S 10/2009 Yokota et al.
D612,347 S 3/2010 Yokota et al.
7,709,292 B2 5/2010 Sadwick et al.
D633,054 S 2/2011 Fujihara et al.
D633,450 S 3/2011 Fujihara et al.
D638,809 S 5/2011 Morikawa et al.
D638,810 S 5/2011 Morikawa et al.
D684,547 S 6/2013 Kawachi et al.
D690,277 S 9/2013 Matsuhisa et al.

D690,672 S 10/2013 Yoshida et al.
D694,200 S 11/2013 Matsuhisa et al.
D699,201 S 2/2014 Petsch
D708,594 S 7/2014 Kiriara et al.
D708,595 S 7/2014 Kiriara et al.
D730,304 S 5/2015 Matsumoto et al.
D736,213 S 8/2015 Kang et al.
D736,216 S 8/2015 Kang et al.
D754,083 S 4/2016 Vinciarelli et al.
D775,092 S * 12/2016 Vinciarelli D13/182
D775,093 S * 12/2016 Vinciarelli D13/182
D798,249 S * 9/2017 Vinciarelli D13/182
2006/0097374 A1 5/2006 Egawa
2009/0004776 A1 1/2009 Ye et al.
2014/0070381 A1 3/2014 Doi et al.
2014/0099805 A1 4/2014 Kutchery et al.
2014/0106621 A1 4/2014 Wu

OTHER PUBLICATIONS

Protek Devices, Package Outline, 16 Pin Drip Package, 2000, 2 pages.

* cited by examiner

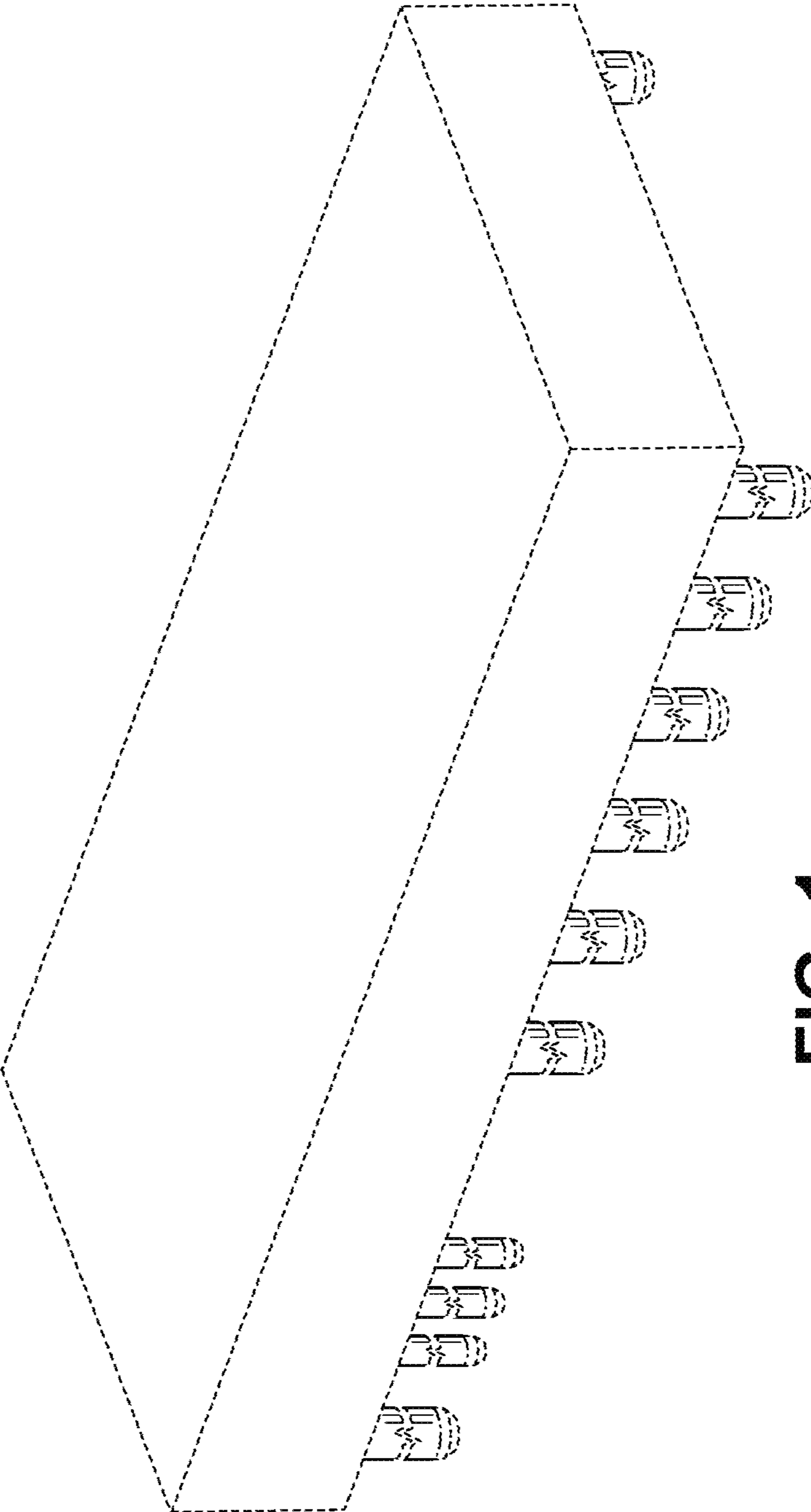

FIG. 1

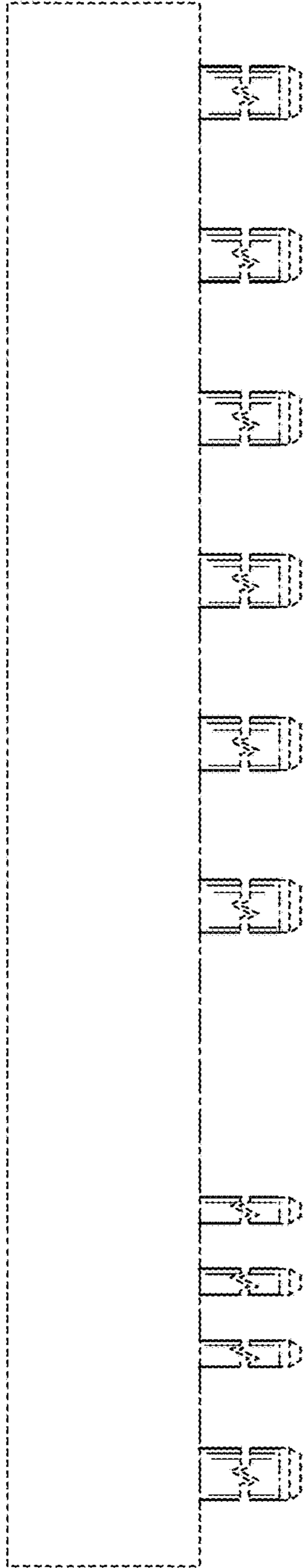

FIG. 2

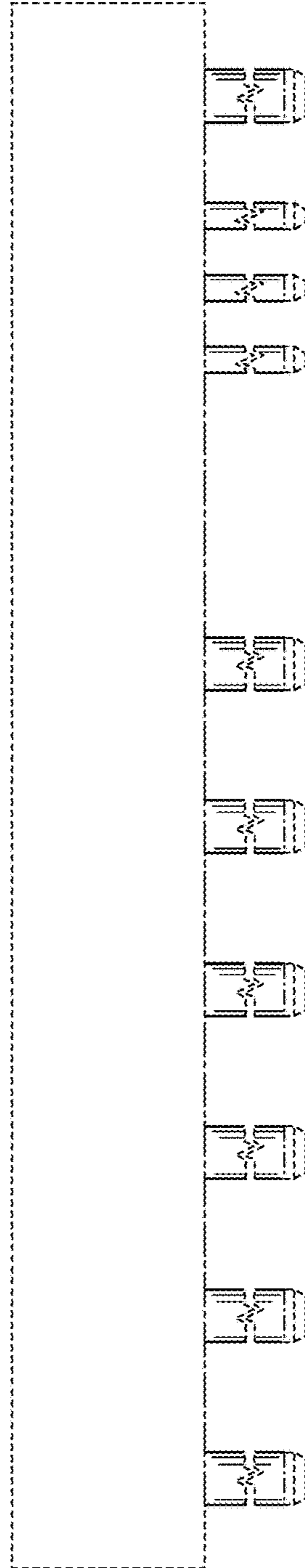

FIG. 3

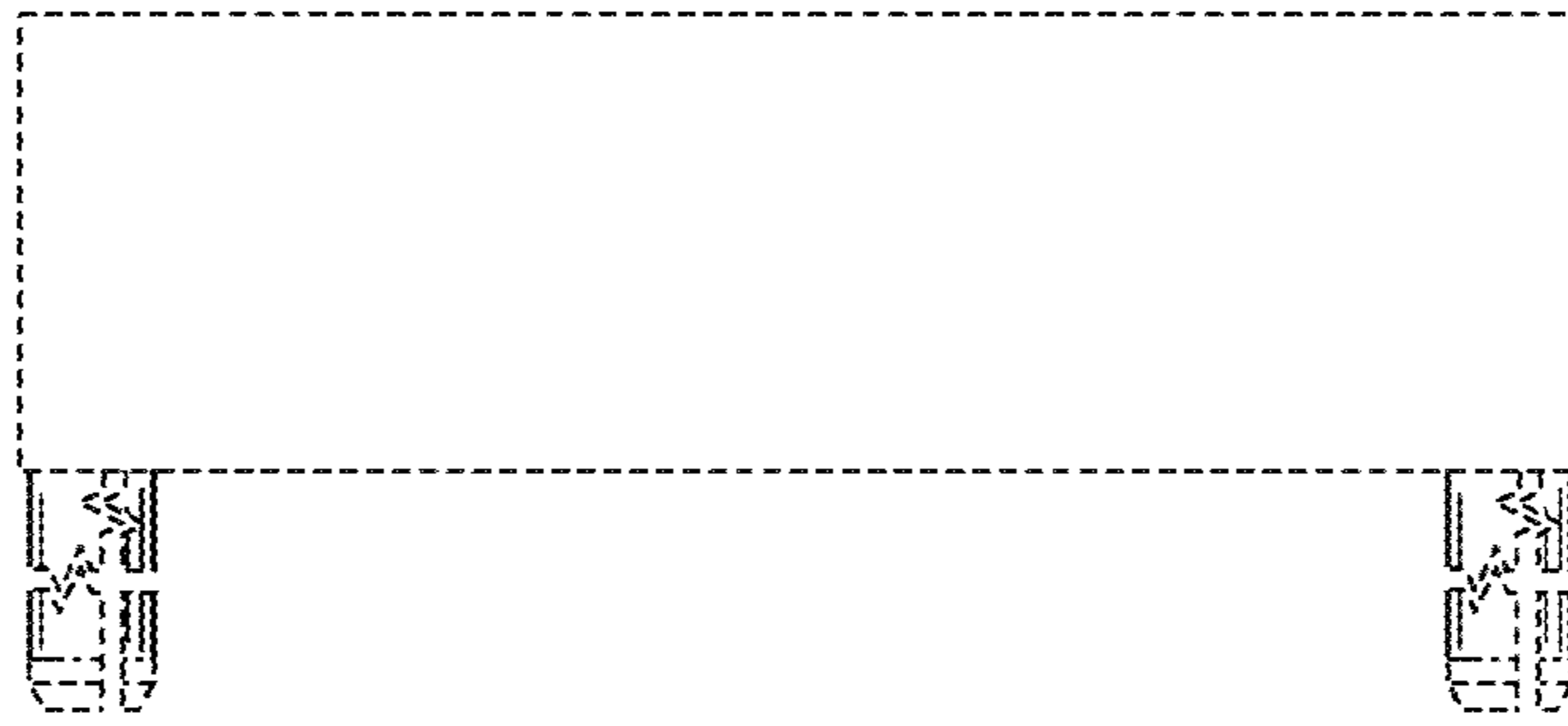

FIG. 4



FIG. 5



FIG. 6

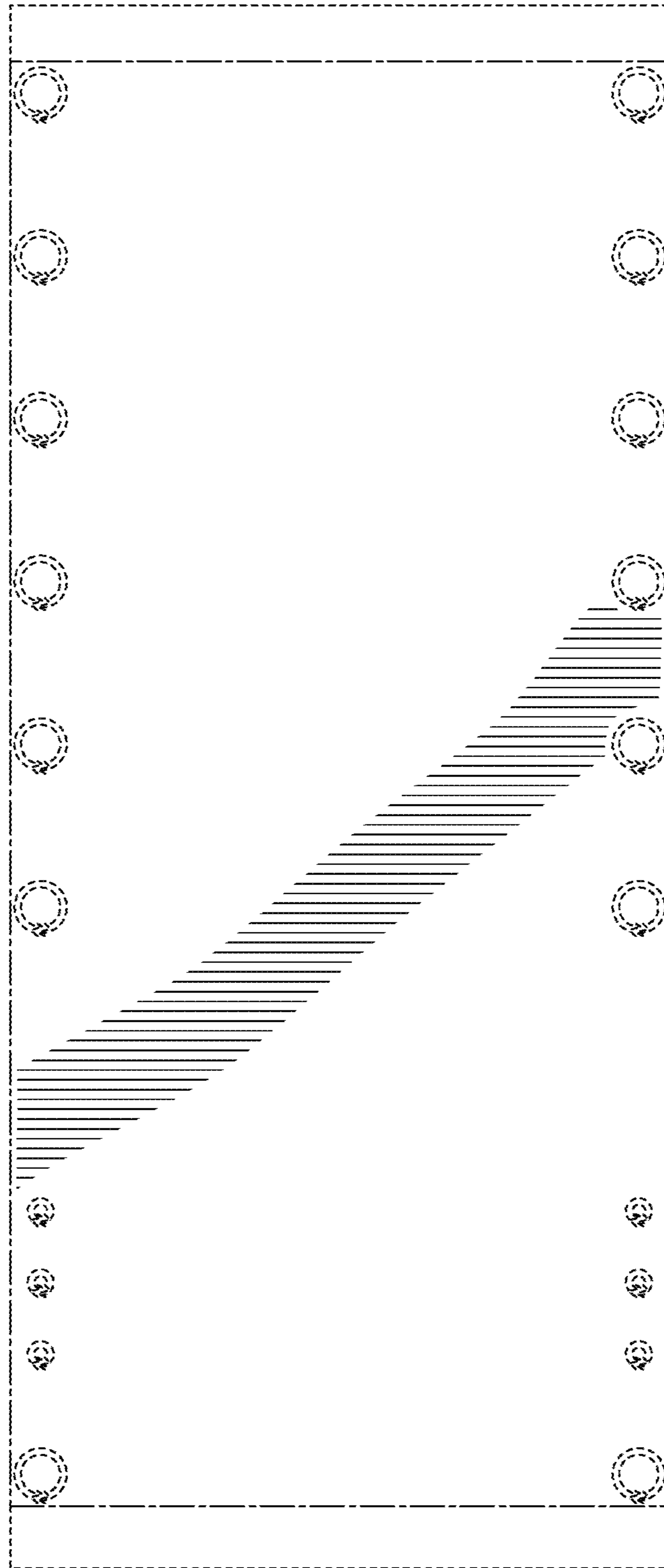

FIG. 7