

US00D834425S

(12) **United States Design Patent** (10) **Patent No.:** **US D834,425 S**  
**Nagata** (45) **Date of Patent:** **\*\* Nov. 27, 2018**

(54) **BOTTLE FOR COSMETICS**  
(71) Applicant: **Kaori Nagata**, Tokyo (JP)  
(72) Inventor: **Kaori Nagata**, Tokyo (JP)  
(73) Assignee: **SHISEIDO CO., LTD.**, Tokyo (JP)  
(\*\*) Term: **15 Years**  
(21) Appl. No.: **29/604,001**  
(22) Filed: **May 15, 2017**  
(51) **LOC (11) Cl.** ..... **09-01**  
(52) **U.S. Cl.**  
USPC ..... **D9/682**; D9/694  
(58) **Field of Classification Search**  
USPC ..... D9/682-694, 695, 697-699, 715, 719,  
D9/723-729, 738, 739, 741, 746,  
D9/500-505, 516, 517, 521, 526, 529,  
D9/544-546, 548, 549-575, 434-436,  
D9/445, 447-449; D28/76, 77, 85, 91.1  
CPC ..... B05B 11/00-11/3098; B65D 83/14; B65D  
83/38; B65D 83/384; B65D 83/40; A45D  
34/00; A45D 34/02; A45D 2034/007;  
A45D 2200/05; A45D 2200/051; A45D  
2200/052; A45D 2200/053; A45D  
2200/054; A45D 2200/055; A45D  
2200/056; A45D 2200/057  
See application file for complete search history.

D425,427 S \* 5/2000 Heeter ..... D9/521  
D437,212 S \* 2/2001 Adachi ..... D9/686  
D615,874 S \* 5/2010 Nagata ..... D9/448  
D652,739 S \* 1/2012 Komai ..... D9/697  
D665,267 S \* 8/2012 Dittmer ..... D9/688  
D696,965 S \* 1/2014 Lee ..... D9/691  
D697,816 S \* 1/2014 Lee ..... D9/691  
D698,662 S \* 2/2014 Kim ..... D9/689  
D777,041 S \* 1/2017 Hui ..... D9/687  
D795,066 S \* 8/2017 Son ..... D9/442  
D807,758 S \* 1/2018 Kim ..... D9/697  
D818,840 S \* 5/2018 Nagata ..... D9/692  
2013/0228482 A1 \* 9/2013 Son ..... A45D 34/00  
206/219  
2015/0266042 A1 \* 9/2015 Corbellini ..... B05B 11/3052  
222/113

\* cited by examiner

*Primary Examiner* — Catherine A Tuttle  
(74) *Attorney, Agent, or Firm* — Manabu Kanesaka

(57) **CLAIM**

The ornamental design for the bottle for cosmetics, as shown and described.

**DESCRIPTION**

FIG. 1 is a perspective view of a bottle for cosmetics showing my new design;  
FIG. 2 is a front view thereof, the rear view being symmetrical to the front view;  
FIG. 3 is a top plan view thereof;  
FIG. 4 is a bottom view thereof;  
FIG. 5 is a left side view thereof;  
FIG. 6 is a right side view thereof; and,  
FIG. 7 is a perspective view shown with the cap removed for a clear disclosure of the underlying parts.  
The broken lines depict the portions of the bottle for cosmetics that form no part of the claimed design.

**1 Claim, 2 Drawing Sheets**

(56) **References Cited**

**U.S. PATENT DOCUMENTS**

D85,737 S \* 12/1931 Wagner ..... D9/529  
3,348,740 A \* 10/1967 O'Donnell ..... B65D 55/02  
222/153.06  
D322,392 S \* 12/1991 Schneider ..... D9/689  
D327,003 S \* 6/1992 Schneider ..... D9/448  
D396,186 S \* 7/1998 Fiore ..... D9/529

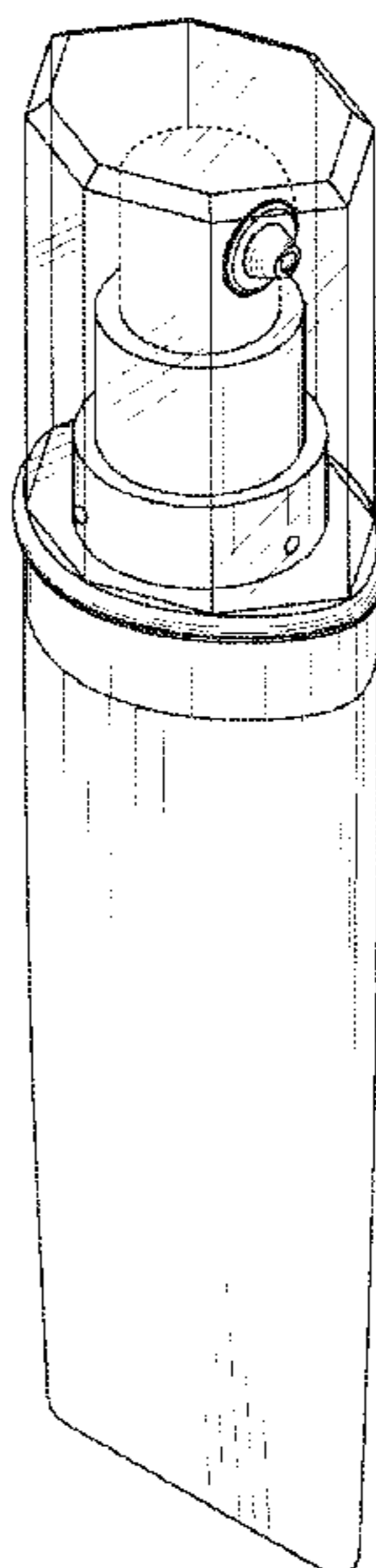

Fig. 1

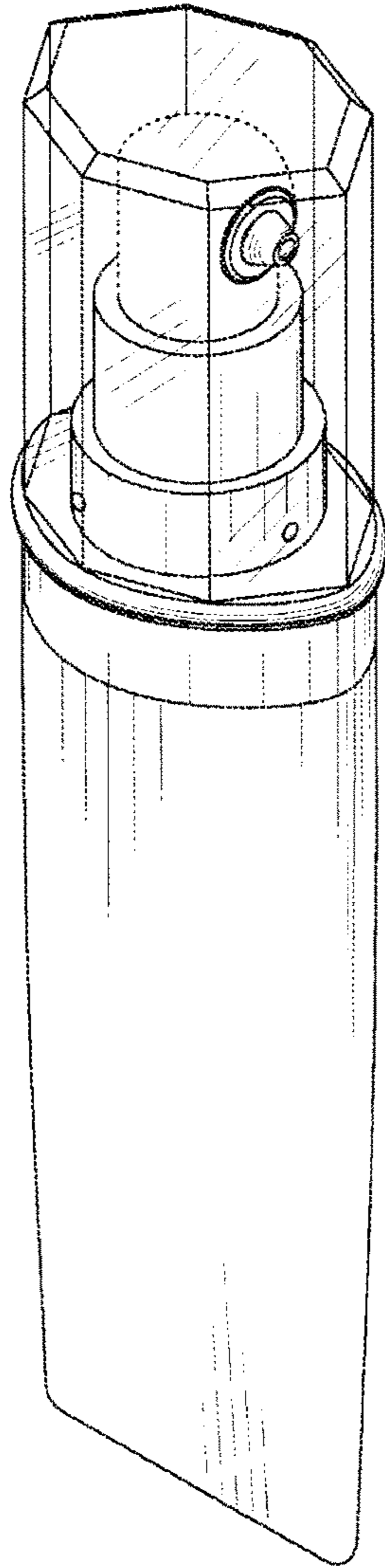

Fig. 2

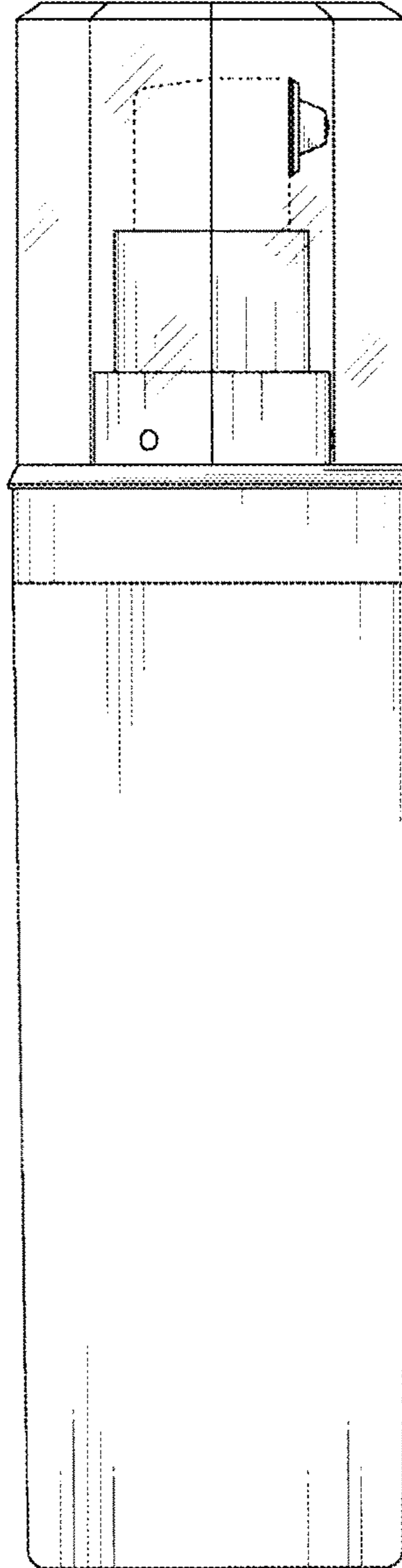

Fig. 3

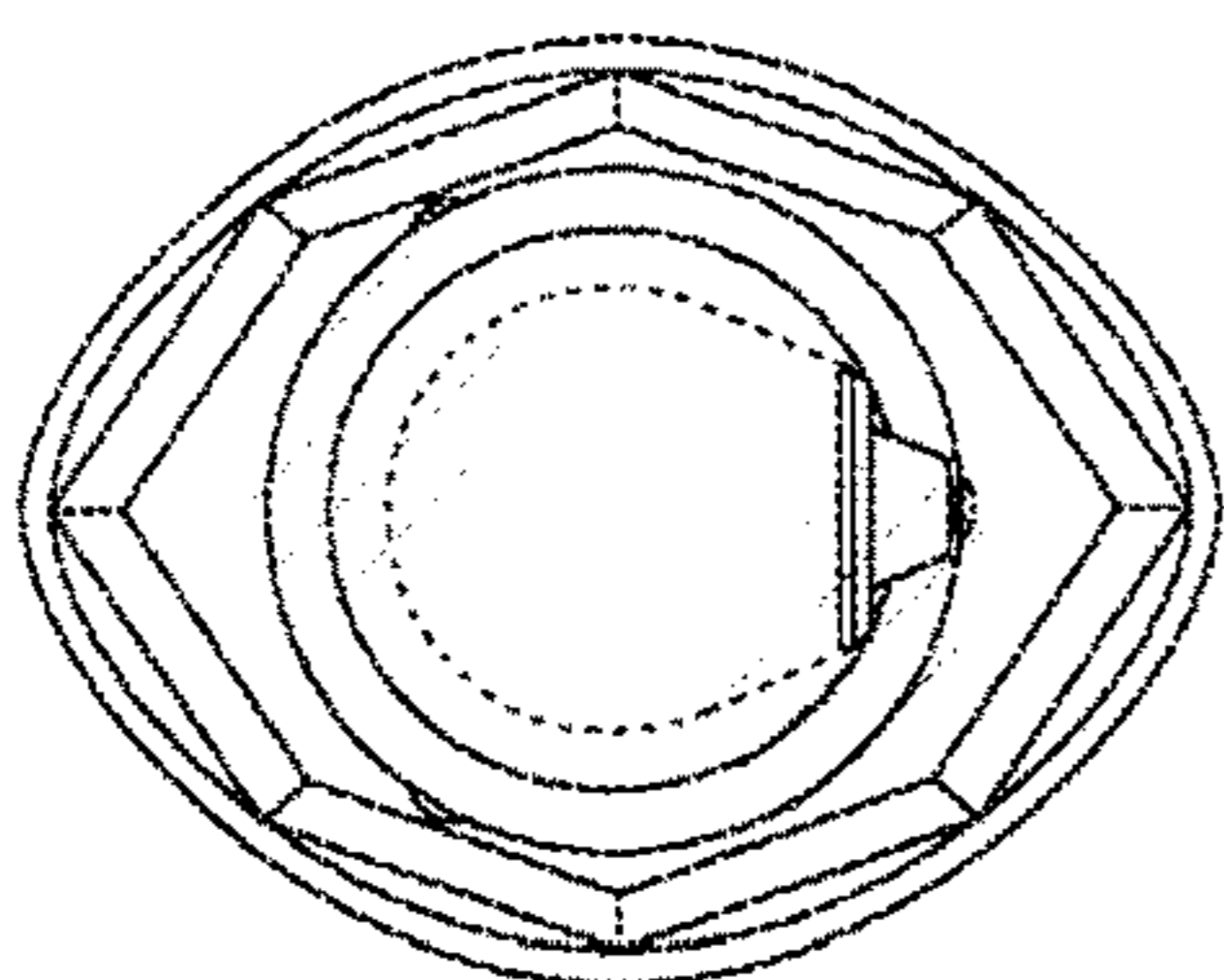

Fig. 4

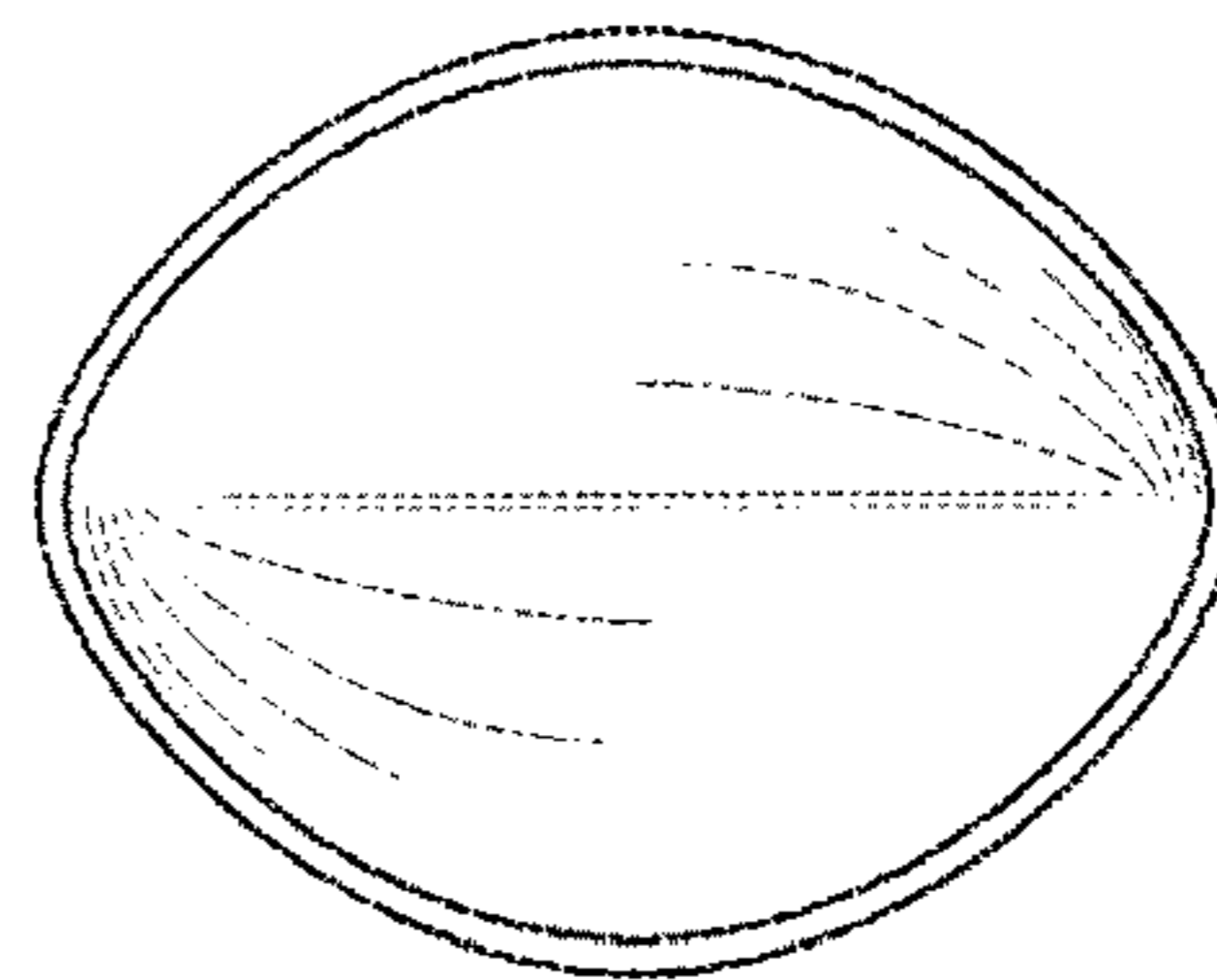

Fig.5

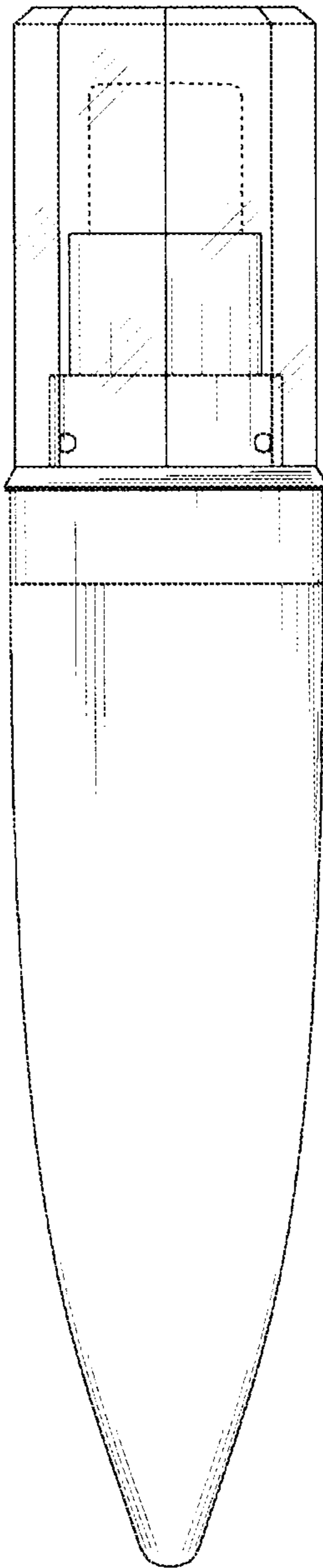

Fig.6

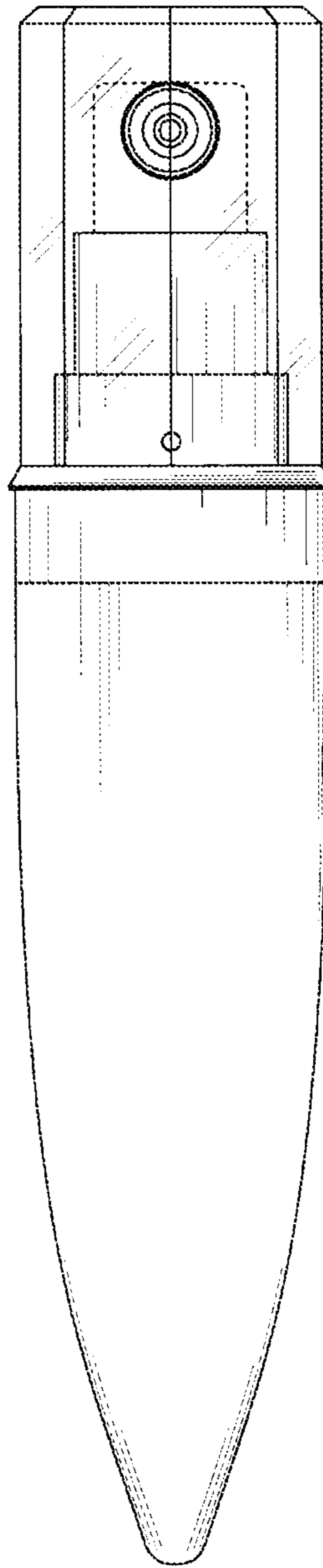

Fig.7

