



US00D834316S

(12) **United States Design Patent** (10) **Patent No.:** **US D834,316 S**  
**Tobyansen et al.** (45) **Date of Patent:** **\*\* Nov. 27, 2018**

(54) **BACKPACK WITH A CONCEALED MIRROR**

backpackn1008w.html, known to be publically available as early as Mar. 8, 2017.

(71) Applicant: **EASTON DIAMOND SPORTS, LLC**,  
Thousand Oaks, CA (US)

\* cited by examiner

(72) Inventors: **Julie Tobyansen**, Thousand Oaks, CA (US); **Abraham Peters**, Thousand Oaks, CA (US); **Scott Bilodeau**, Thousand Oaks, CA (US)

*Primary Examiner* — Holly H Baynham  
(74) *Attorney, Agent, or Firm* — Perkins Coie LLP

(73) Assignee: **EASTON DIAMOND SPORTS, LLC**,  
Thousand Oaks, CA (US)

(57) **CLAIM**

The ornamental design for a backpack with a concealed mirror, as shown and described.

(\*\*) Term: **15 Years**

**DESCRIPTION**

(21) Appl. No.: **29/597,010**

(22) Filed: **Mar. 13, 2017**

(51) **LOC (11) Cl.** ..... **03-01**

(52) **U.S. Cl.**  
USPC ..... **D3/318**

(58) **Field of Classification Search**  
USPC ..... D3/232–233, 240–243, 245–246, 318  
CPC ..... A45C 1/024; A45C 3/06  
See application file for complete search history.

FIG. 1 is a front, top and left side perspective view showing our new design, with the top flap down or closed.  
FIGS. 2-7 are views of the backpack with a concealed mirror as it is shown in FIG. 1, wherein:  
FIG. 2 is a front view.  
FIG. 3 is a back view.  
FIG. 4 is a left side view.  
FIG. 5 is a right side view.  
FIG. 6 is a top view.  
FIG. 7 is a bottom view.  
FIG. 8 is a front, top and left side perspective view showing the backpack with a concealed mirror of FIGS. 1 to 7 with the top flap up or open.  
FIGS. 9 to 14 are views of the backpack with a concealed mirror as it is shown in FIG. 8, wherein:  
FIG. 9 is a front view.  
FIG. 10 is a back view.  
FIG. 11 is a left side view.  
FIG. 12 is a right side view.  
FIG. 13 is a top view; and,  
FIG. 14 is a bottom view.  
Dotted lines indicate unclaimed subject matter.

(56) **References Cited**

**U.S. PATENT DOCUMENTS**

5,503,204 A \* 4/1996 Byers ..... A45C 3/08  
150/103  
D507,881 S \* 8/2005 Kotorov ..... D3/326  
7,604,102 B2 10/2009 Albritton et al.  
8,403,011 B1 \* 3/2013 McKendry ..... A45C 3/08  
150/100

**OTHER PUBLICATIONS**

Soffe, Intensity on Deck Bat Backpack, <http://www.soffebusiness.com/intensity-athletics/for-her/accessories/on-deck-bat->

**1 Claim, 14 Drawing Sheets**

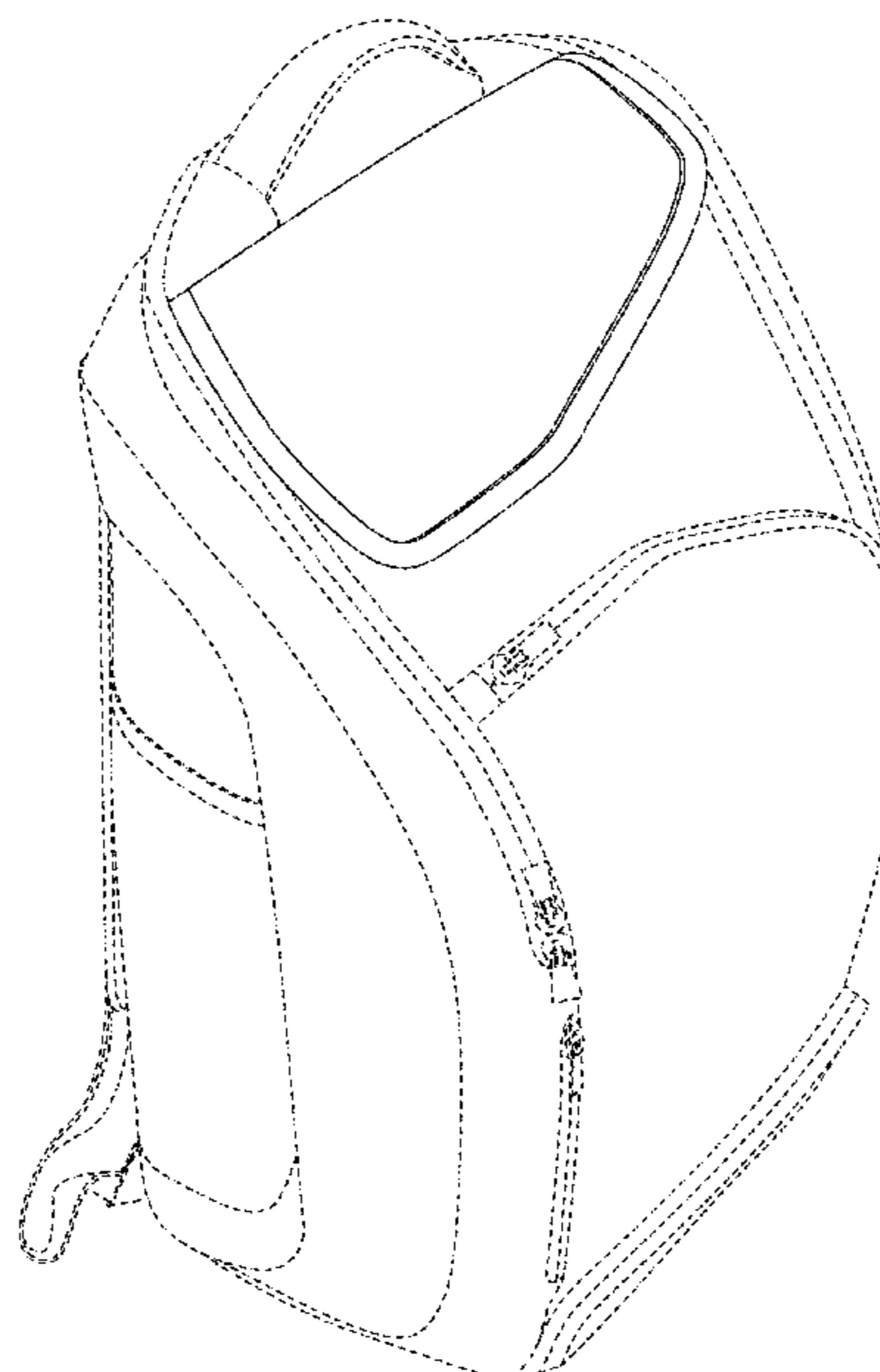

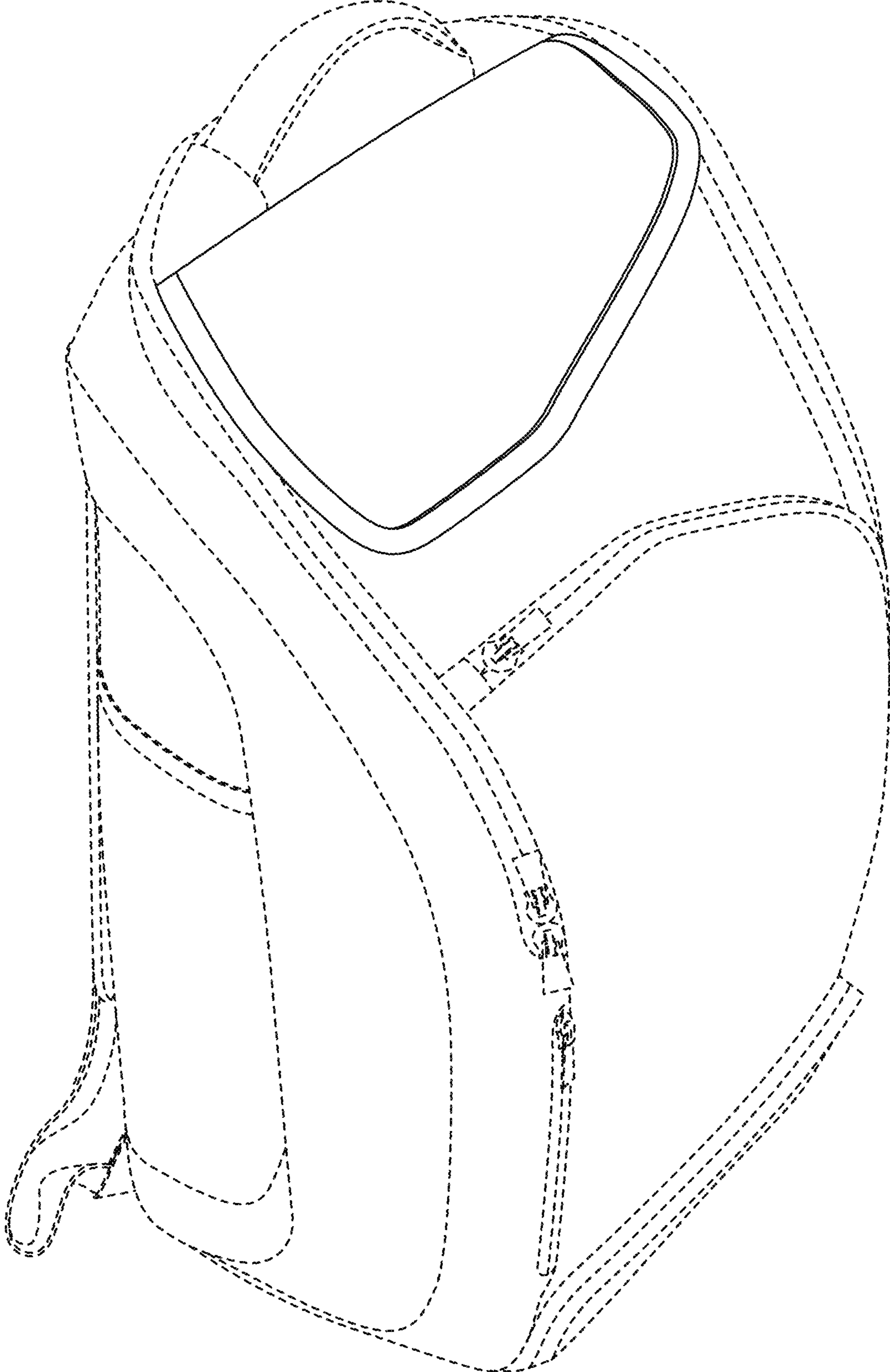

FIG. 1

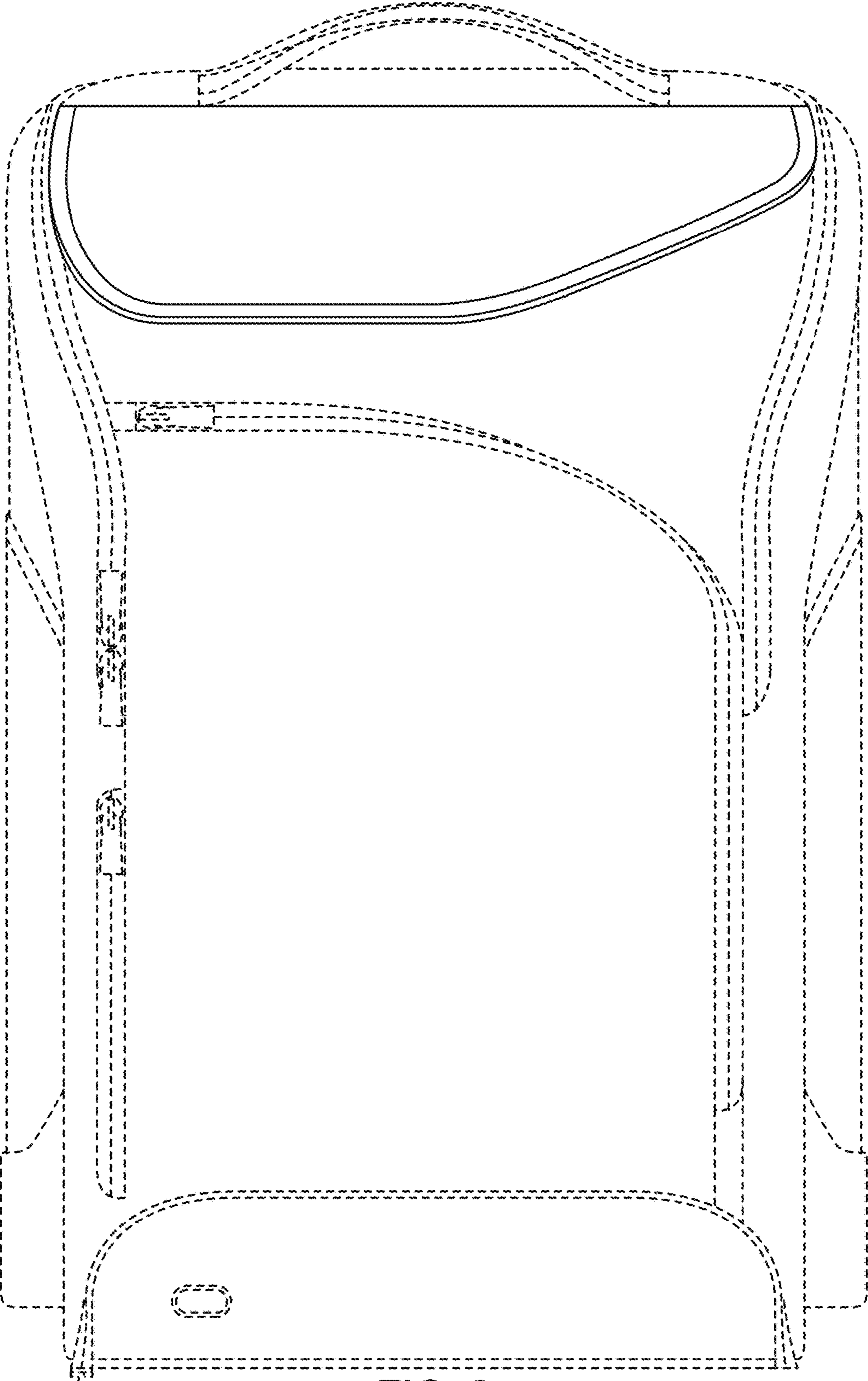

FIG. 2

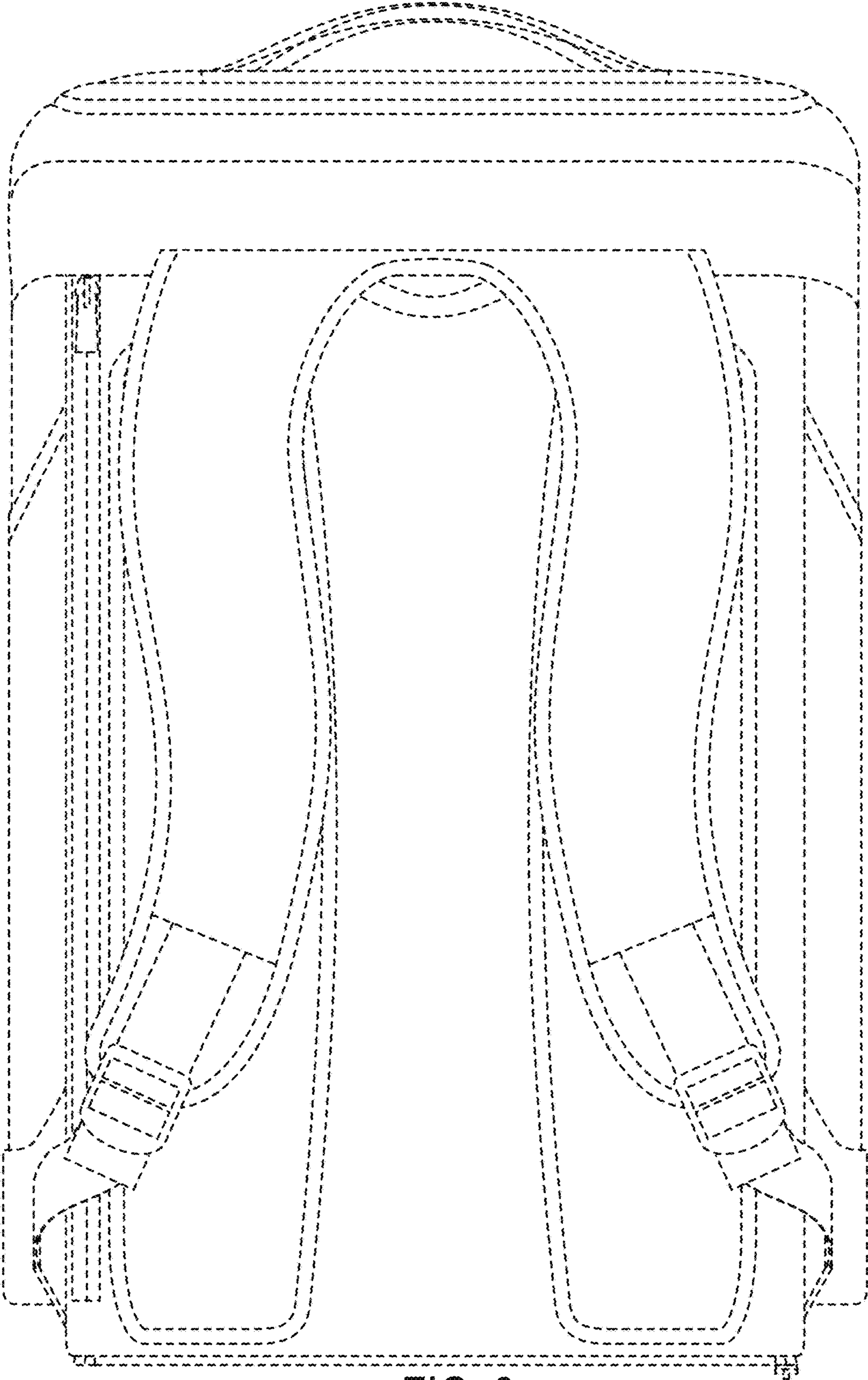

FIG. 3

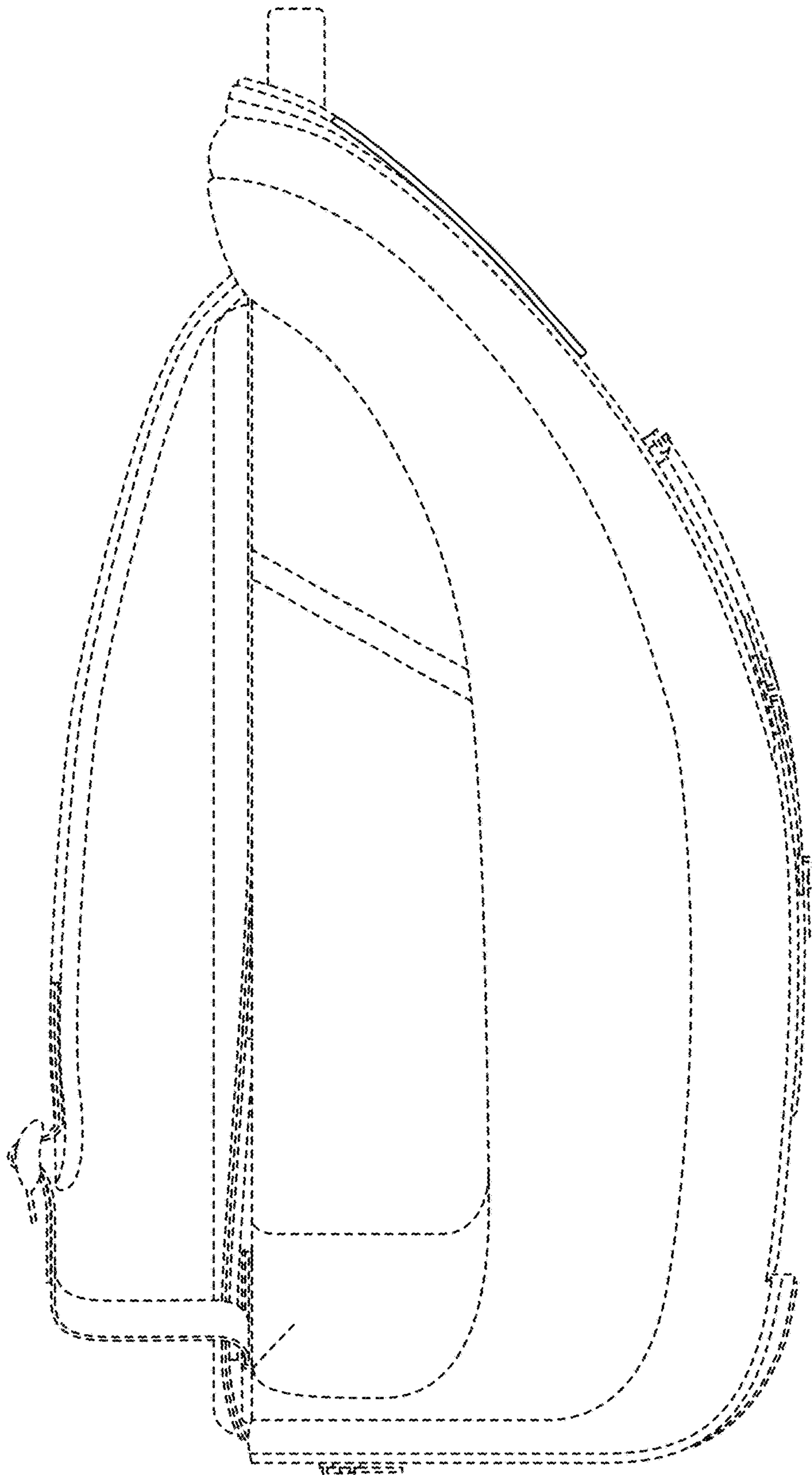

FIG. 4

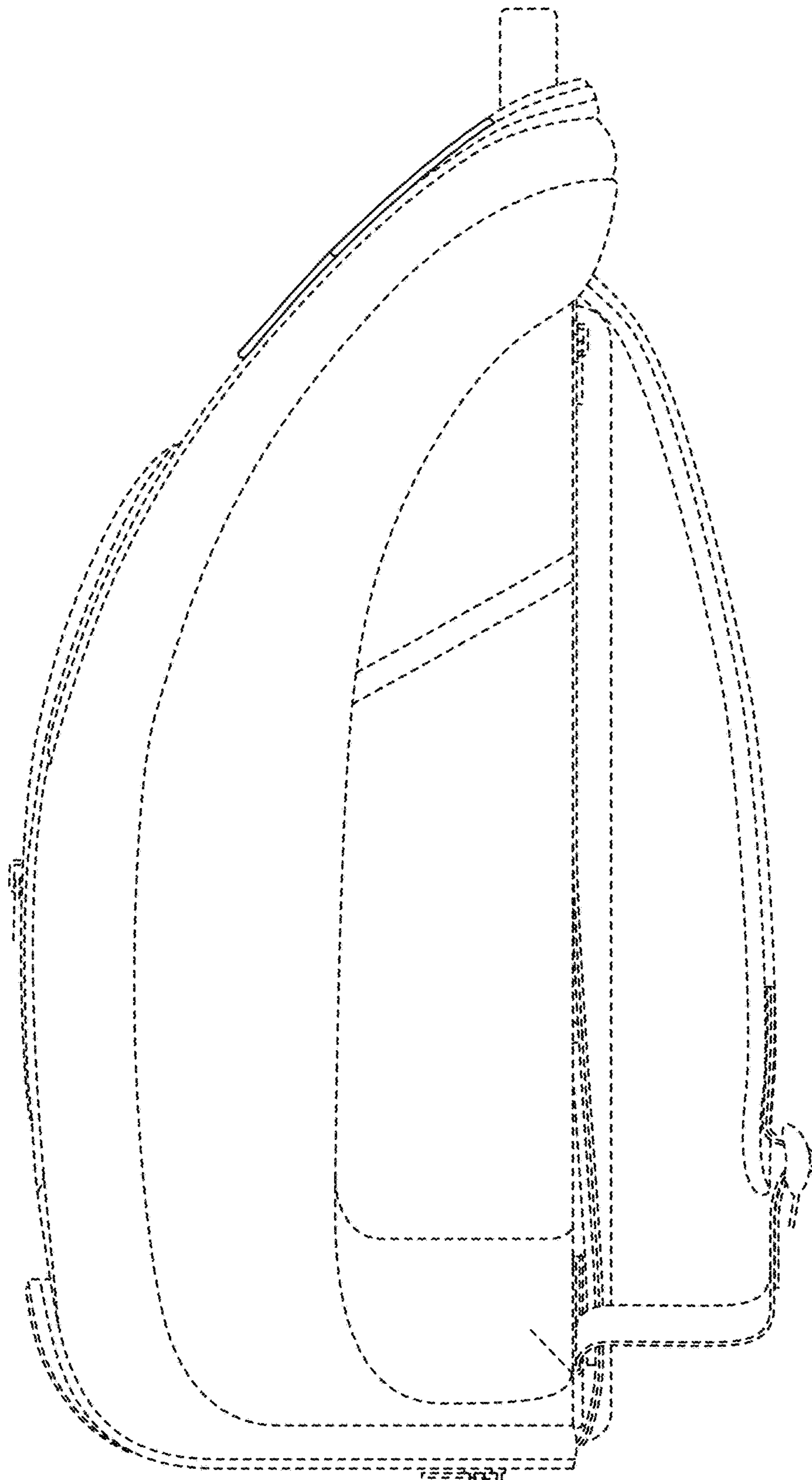

FIG. 5

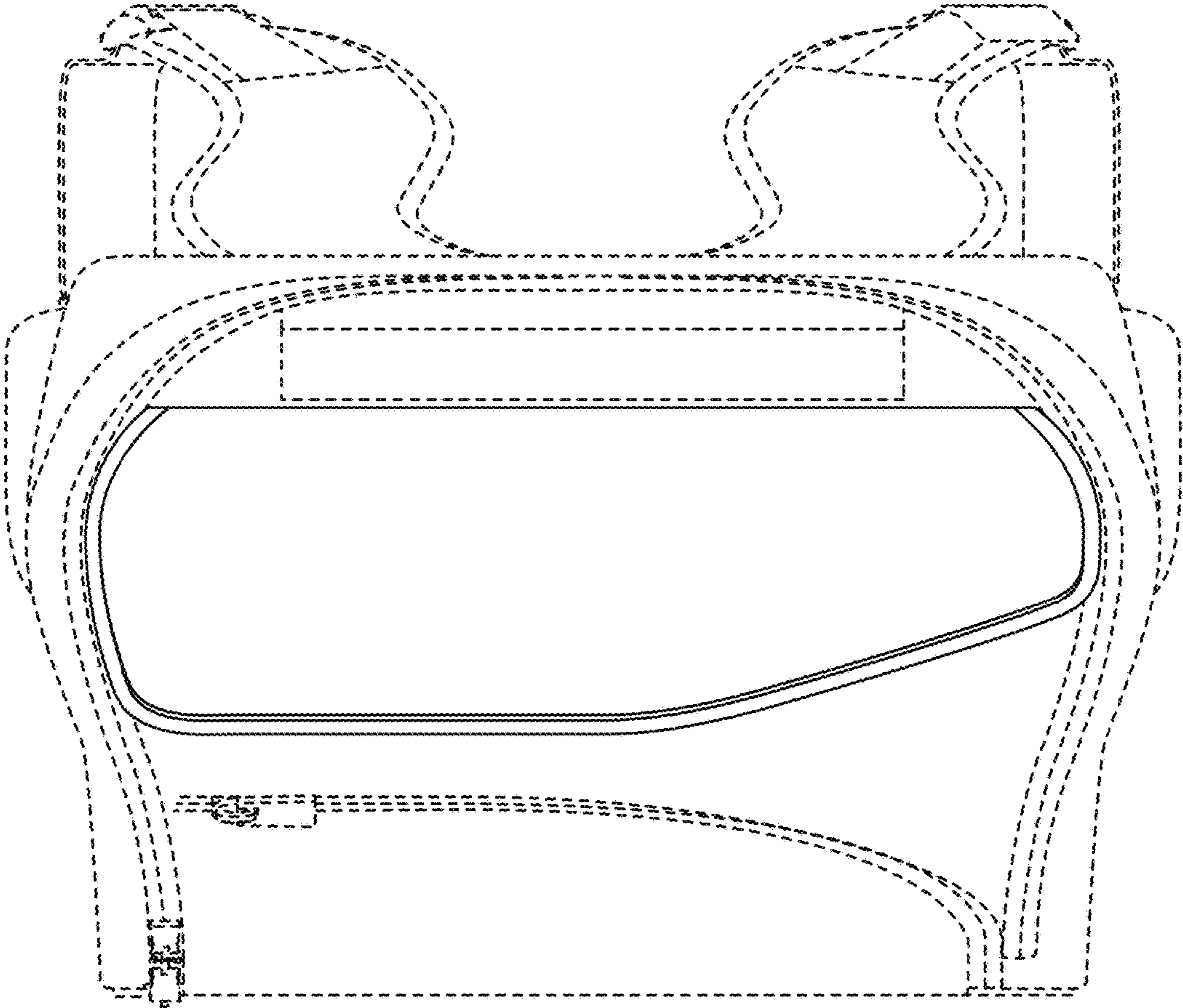

FIG. 6

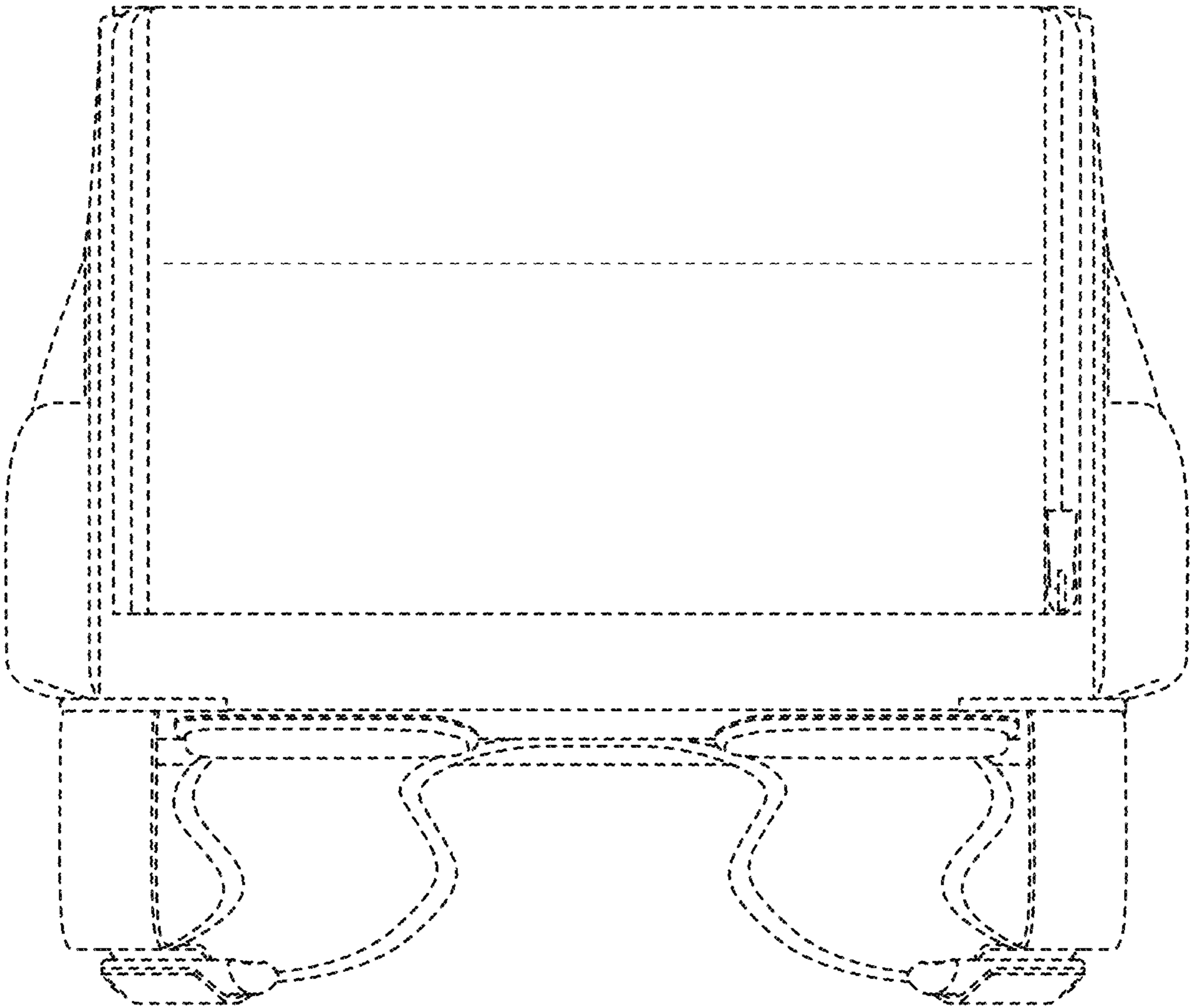

FIG. 7



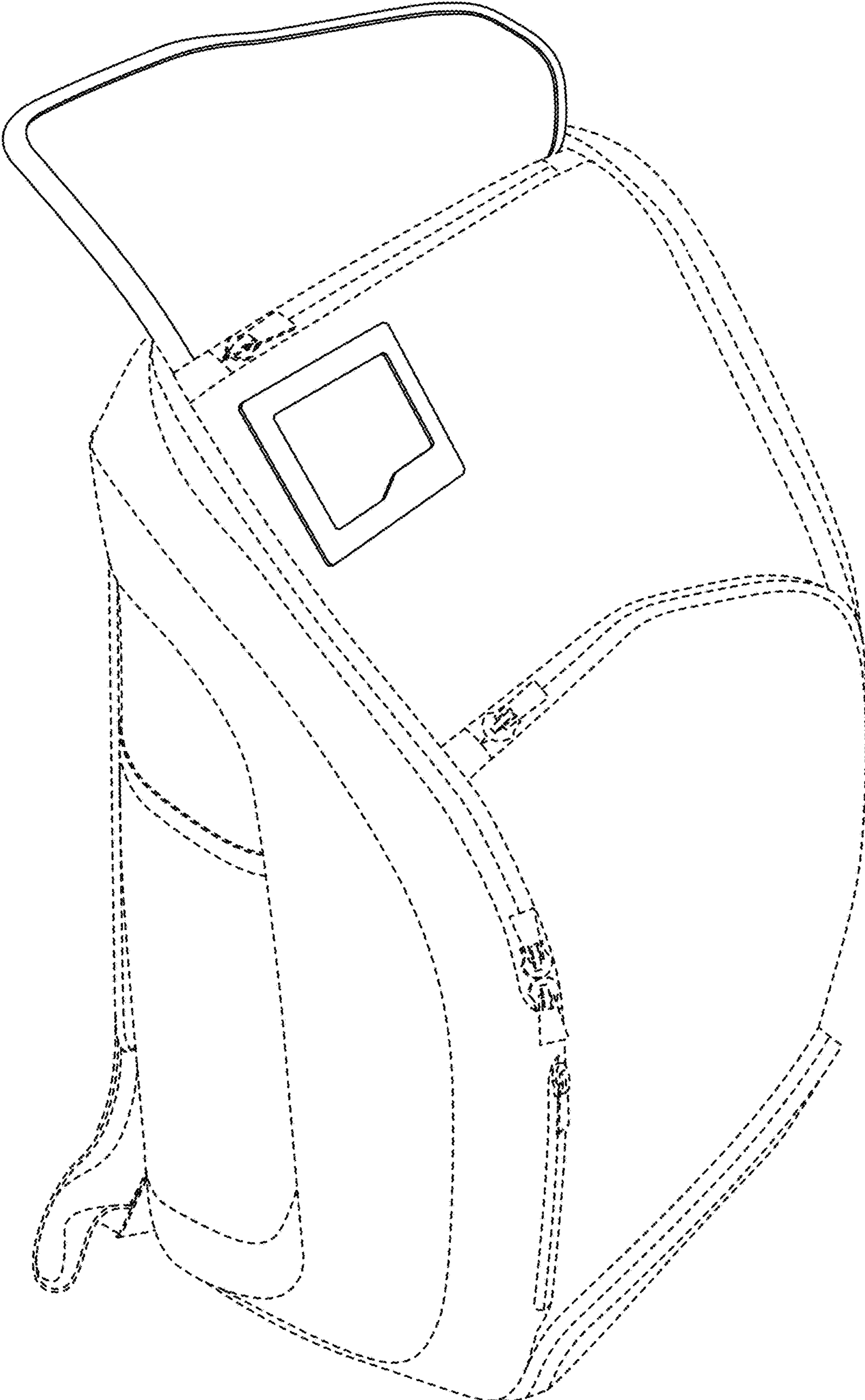

FIG. 8

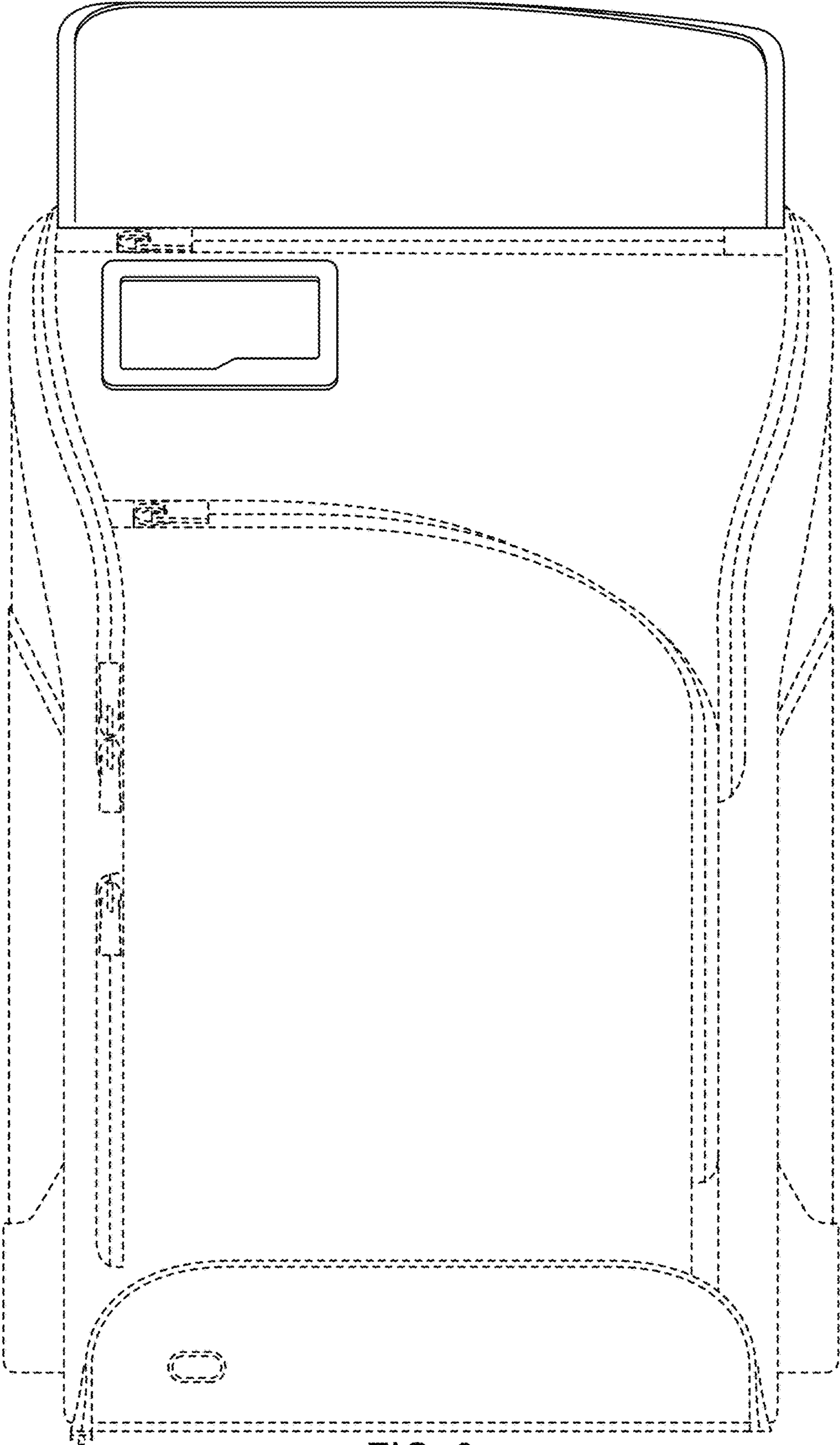

FIG. 9

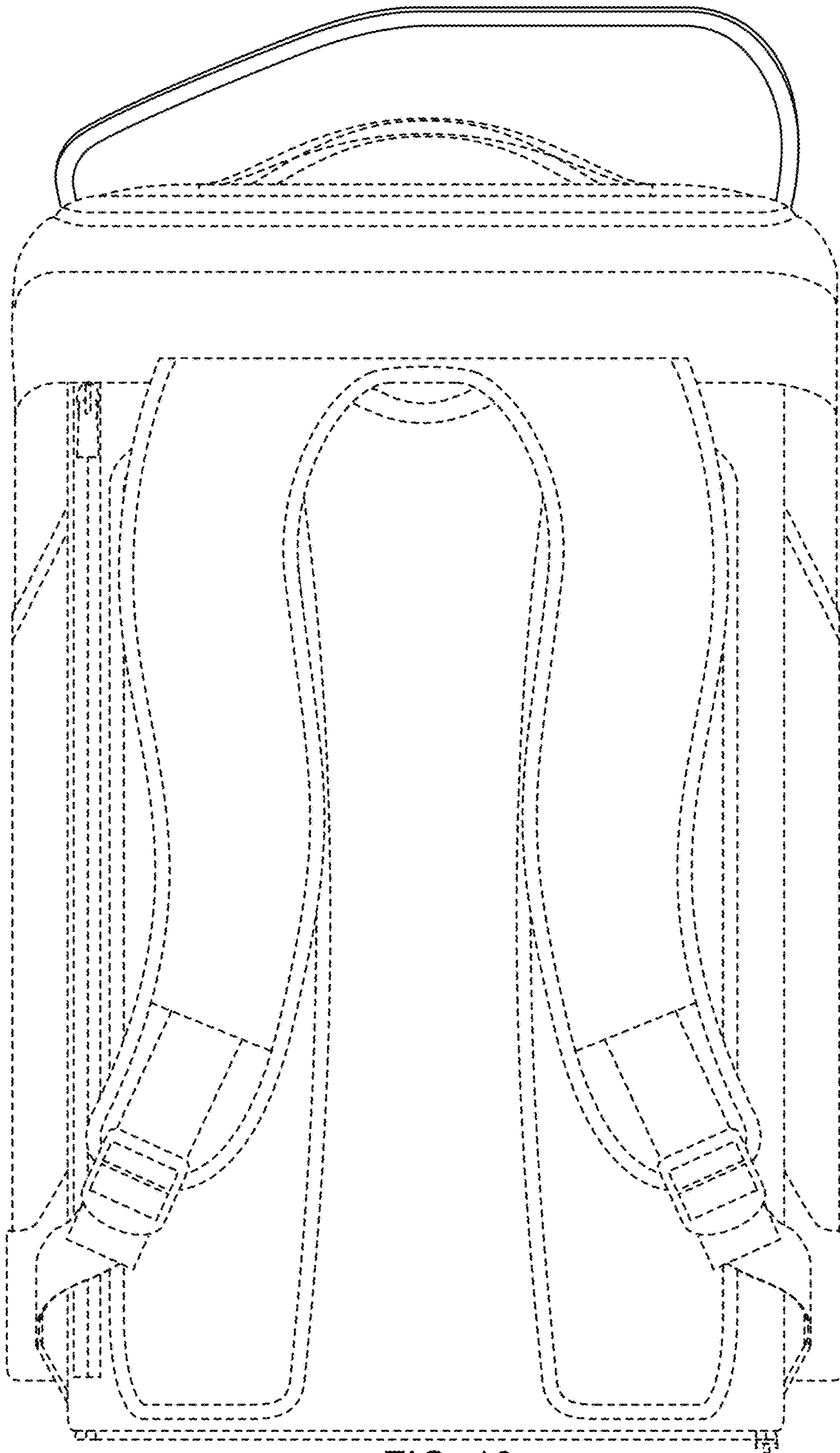

FIG. 10

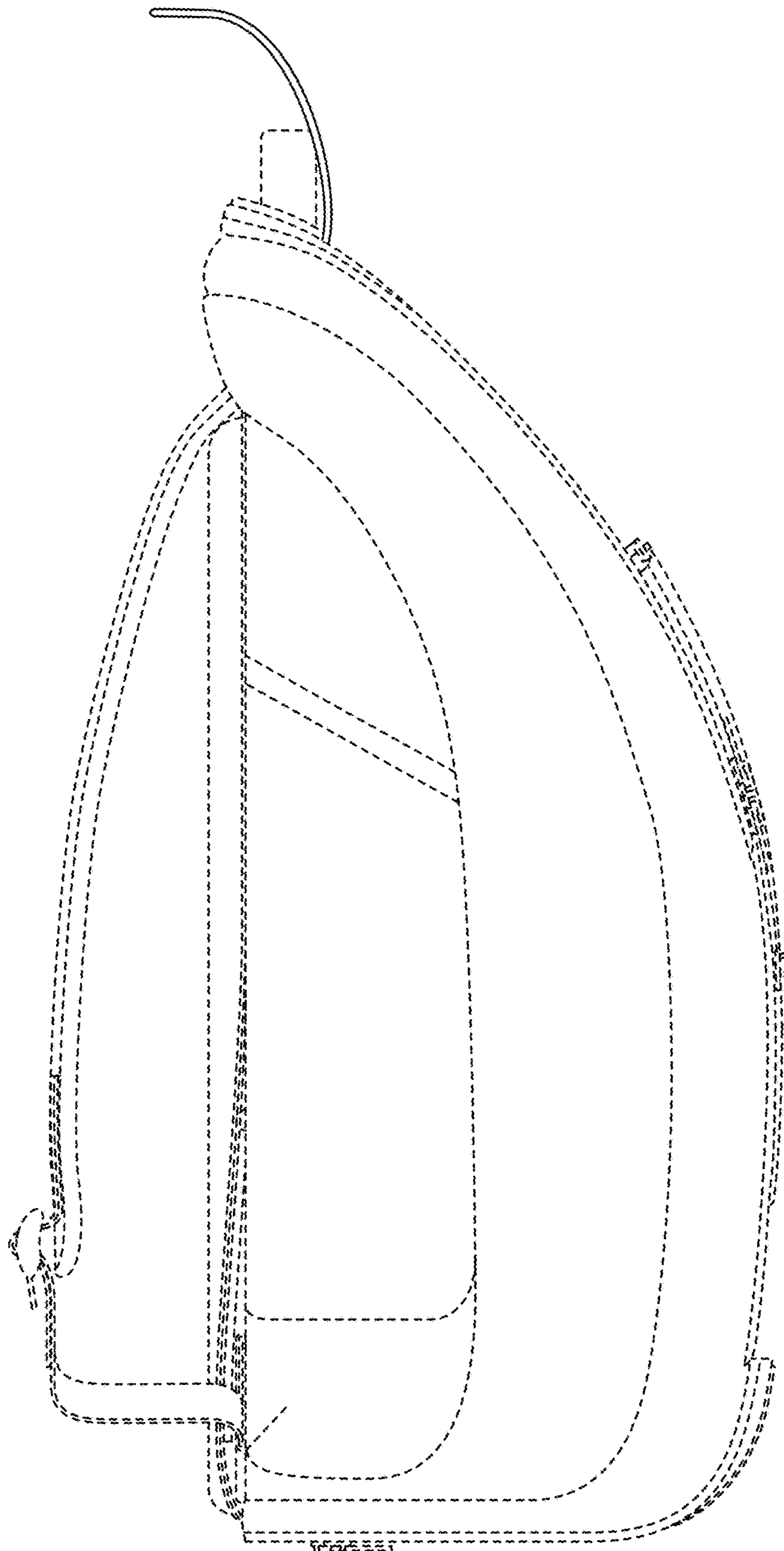

FIG. 11

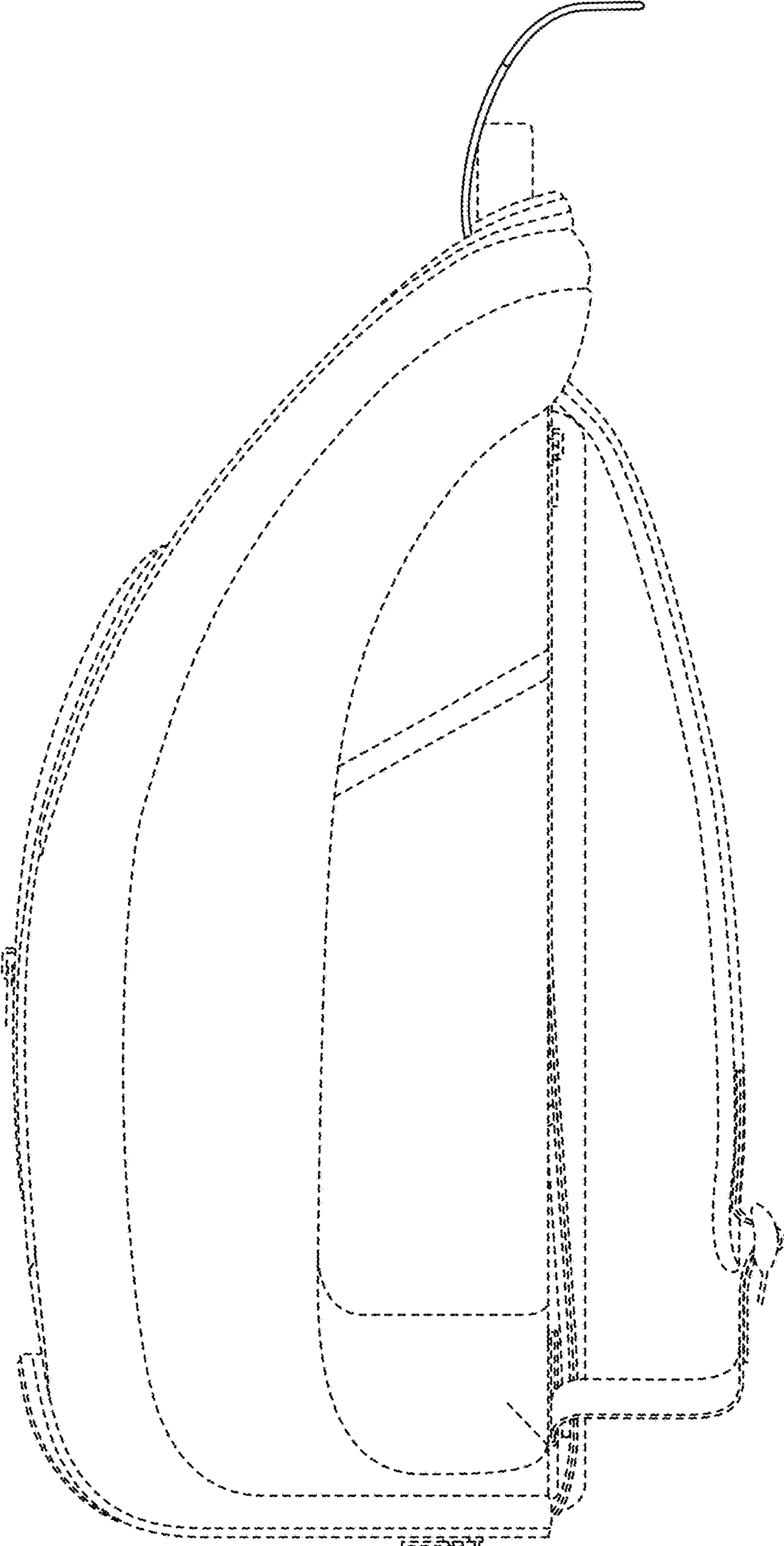

FIG. 12

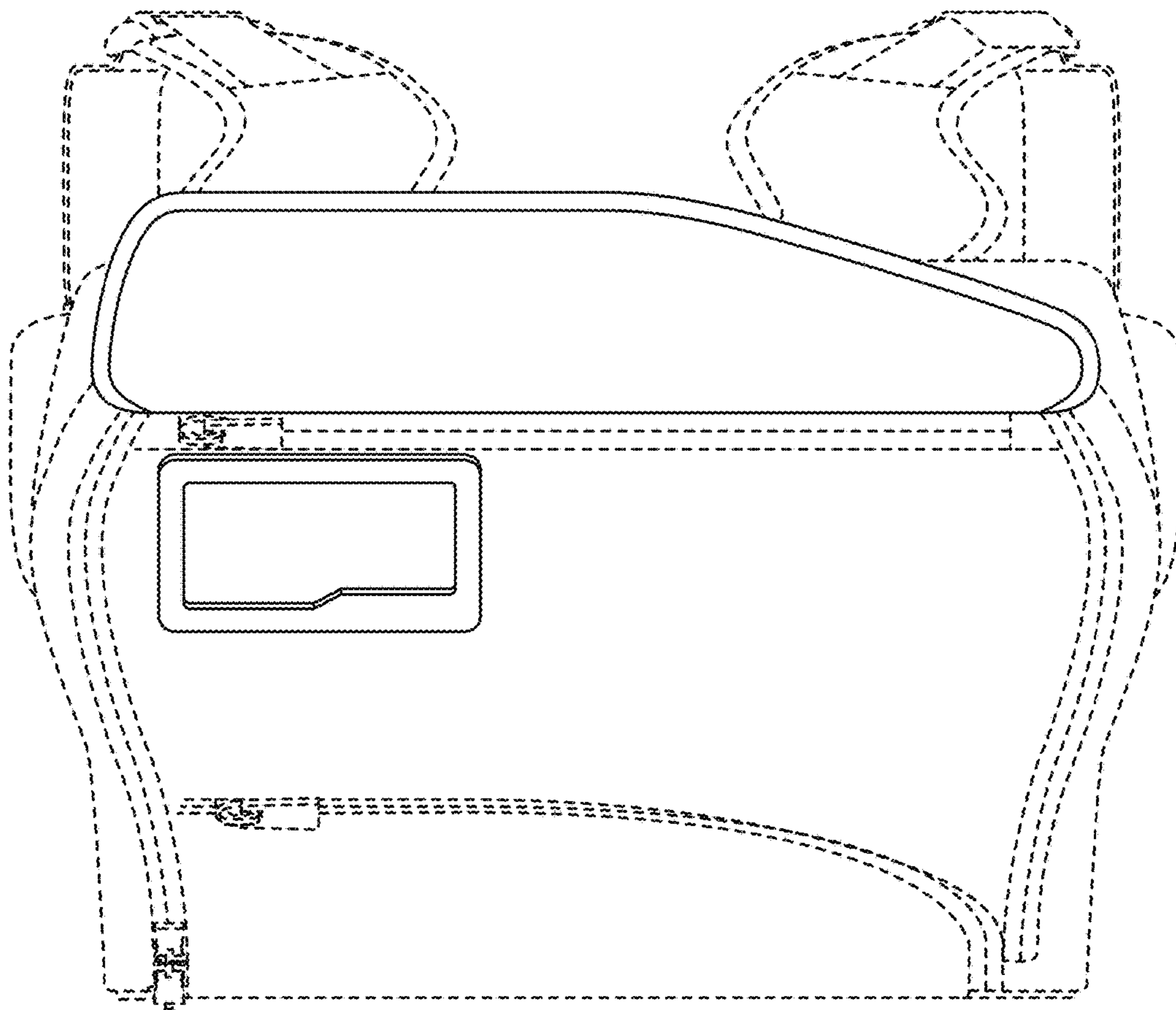

FIG. 13

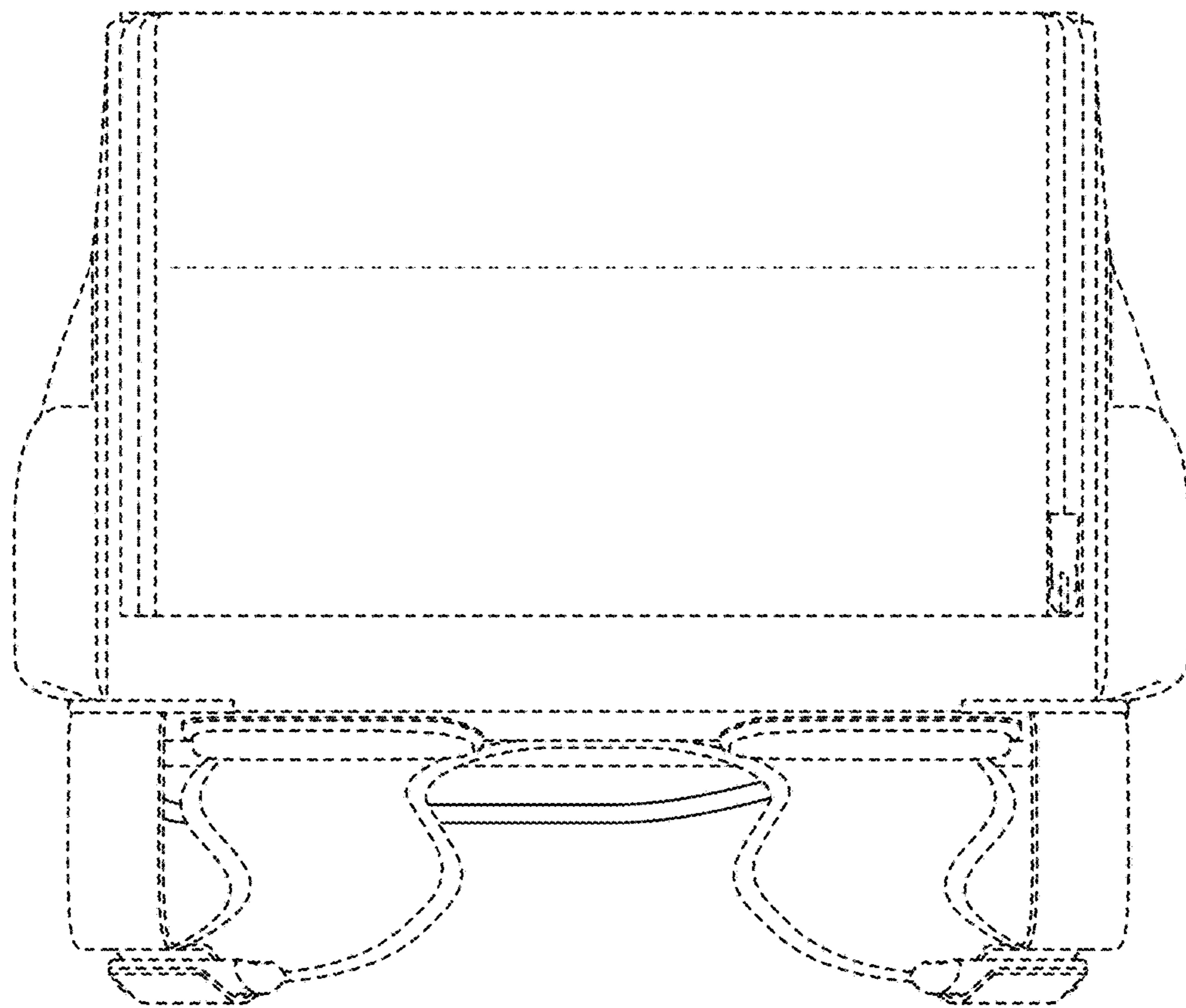

FIG. 14