



US00D834294S

(12) **United States Design Patent** (10) **Patent No.:** **US D834,294 S**  
**Small** (45) **Date of Patent:** **\*\* Nov. 27, 2018**

(54) **SHOE**

(71) Applicant: **NIKE, Inc.**, Beaverton, OR (US)

(72) Inventor: **Jessica Small**, Portland, OR (US)

(73) Assignee: **NIKE, Inc.**, Beaverton, OR (US)

(\*\*) Term: **15 Years**

(21) Appl. No.: **29/584,236**

(22) Filed: **Nov. 12, 2016**

(51) **LOC (11) Cl.** ..... **02-04**

(52) **U.S. Cl.**

USPC ..... **D2/969**

(58) **Field of Classification Search**

USPC ..... D2/896, 902, 905, 906, 907, 908, 909,  
D2/910, 911, 912, 943, 944, 946, 947,  
D2/951, 960, 969, 972, 976, 977; D5/47,  
D5/49, 54

CPC .... A43B 1/00; A43B 1/10; A43B 1/14; A43B  
3/00; A43B 5/00; A43B 5/001; A43B  
5/002; A43B 5/003; A43B 5/007; A43B  
5/008; A43B 5/02; A43B 5/025; A43B  
5/06; A43B 5/08; A43B 5/10; A43B 5/12;  
A43B 5/14; A43B 13/00; A43B 13/02;  
A43B 13/04; A43B 13/14; A43B 13/18;  
A43B 13/32; A43B 23/00; A43B 23/021;  
A43B 23/0205; A43B 23/24; A43B 1/04;  
A43B 11/14; A43B 7/00; A43B 3/12;  
A43B 13/181; A43B 13/141; A43B  
13/186; A43B 13/188; A43B 23/02; A43B  
23/26

See application file for complete search history.

(56) **References Cited**

**U.S. PATENT DOCUMENTS**

D590,138 S \* 4/2009 Cofinco ..... D2/902  
D595,484 S \* 7/2009 Purdom ..... D2/907

(Continued)

**OTHER PUBLICATIONS**

Nike Flyknit Racer [online], [retrieved Mar. 1, 2017] retrieved from internet <URL: <<http://news.nike.com/footwear/nike-flyknit-racer-rainbow>>; 1 color sheet, Dated May 13, 2016.

(Continued)

*Primary Examiner* — Elizabeth J Oswecki

(74) *Attorney, Agent, or Firm* — Banner & Witcoff, Ltd.

(57) **CLAIM**

The ornamental design for a shoe, as shown and described.

**DESCRIPTION**

The file of this patent contains at least one drawing/photograph executed in color. Copies of this patent with color drawing(s)/photograph(s) will be provided by the Office upon request and payment of the necessary fee.

FIG. 1 is a front perspective view of a first embodiment of a shoe showing my new design;

FIG. 2 is a side view thereof;

FIG. 3 is an opposite side view thereof;

FIG. 4 is a front view thereof;

FIG. 5 is a rear view thereof;

FIG. 6 is a top view thereof;

FIG. 7 is a bottom view thereof;

FIG. 8 is a front perspective view of a second embodiment of a shoe showing my new design;

FIG. 9 is a side view thereof;

FIG. 10 is an opposite side view thereof;

FIG. 11 is a front view thereof;

FIG. 12 is a rear view thereof;

FIG. 13 is a top view thereof; and,

FIG. 14 is a bottom view thereof.

The broken lines shown in the drawings represent portions of the shoe that form no part of the claimed design.

**1 Claim, 14 Drawing Sheets**  
**(14 of 14 Drawing Sheet(s) Filed in Color)**



(56)

**References Cited**

U.S. PATENT DOCUMENTS

D662,695	S	*	7/2012	McVicker	.....	D2/902
D671,718	S	*	12/2012	McVicker	.....	D2/908
D735,976	S	*	8/2015	Siegel	.....	D2/908
D774,287	S	*	12/2016	Taestensen	.....	D2/908
D798,547	S	*	10/2017	Hobson	.....	D2/908
D805,273	S	*	12/2017	Birkinhead	.....	D2/908
D809,253	S	*	2/2018	Brunner	.....	D2/902
D814,780	S	*	4/2018	Goto	.....	D2/972
2005/0016023	A1	*	1/2005	Burriss	.....	A43B 5/02 36/45
2013/0031805	A1	*	2/2013	Crowley, II	.....	A43B 7/144 36/103
2013/0212909	A1	*	8/2013	Bates	.....	A43B 13/189 36/102

OTHER PUBLICATIONS

Nike Footwear Catalog, 1981 Shoe Show, p. 3, published Jan. 1981, NIKE, Inc., USA.

Nike Footwear Catalog, 2010 Fall Indie Sportswear Footwear, p. 5, published date unknown, but prior to the filing date of the present application, NIKE, Inc., USA.

\* cited by examiner

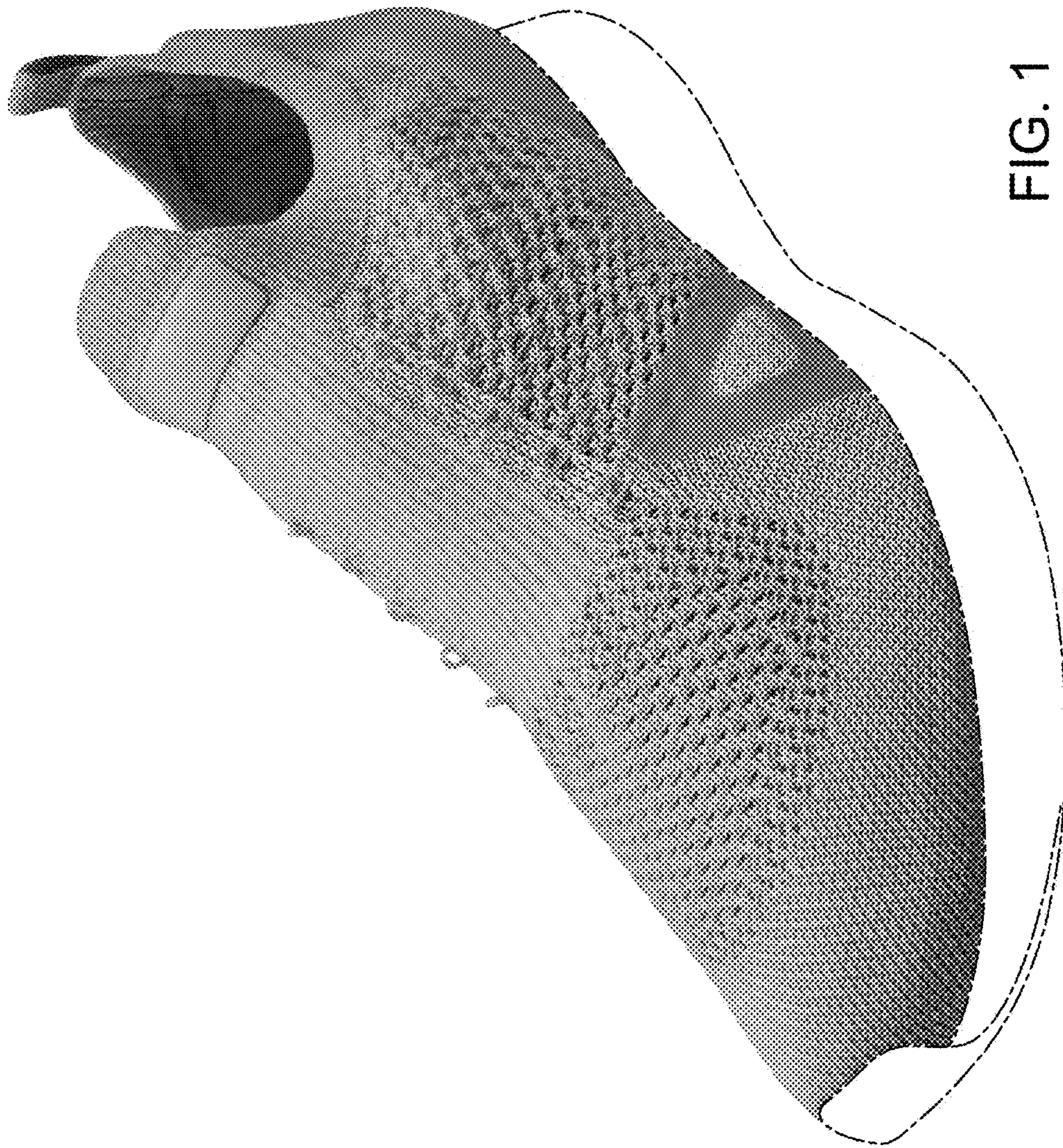

FIG. 1

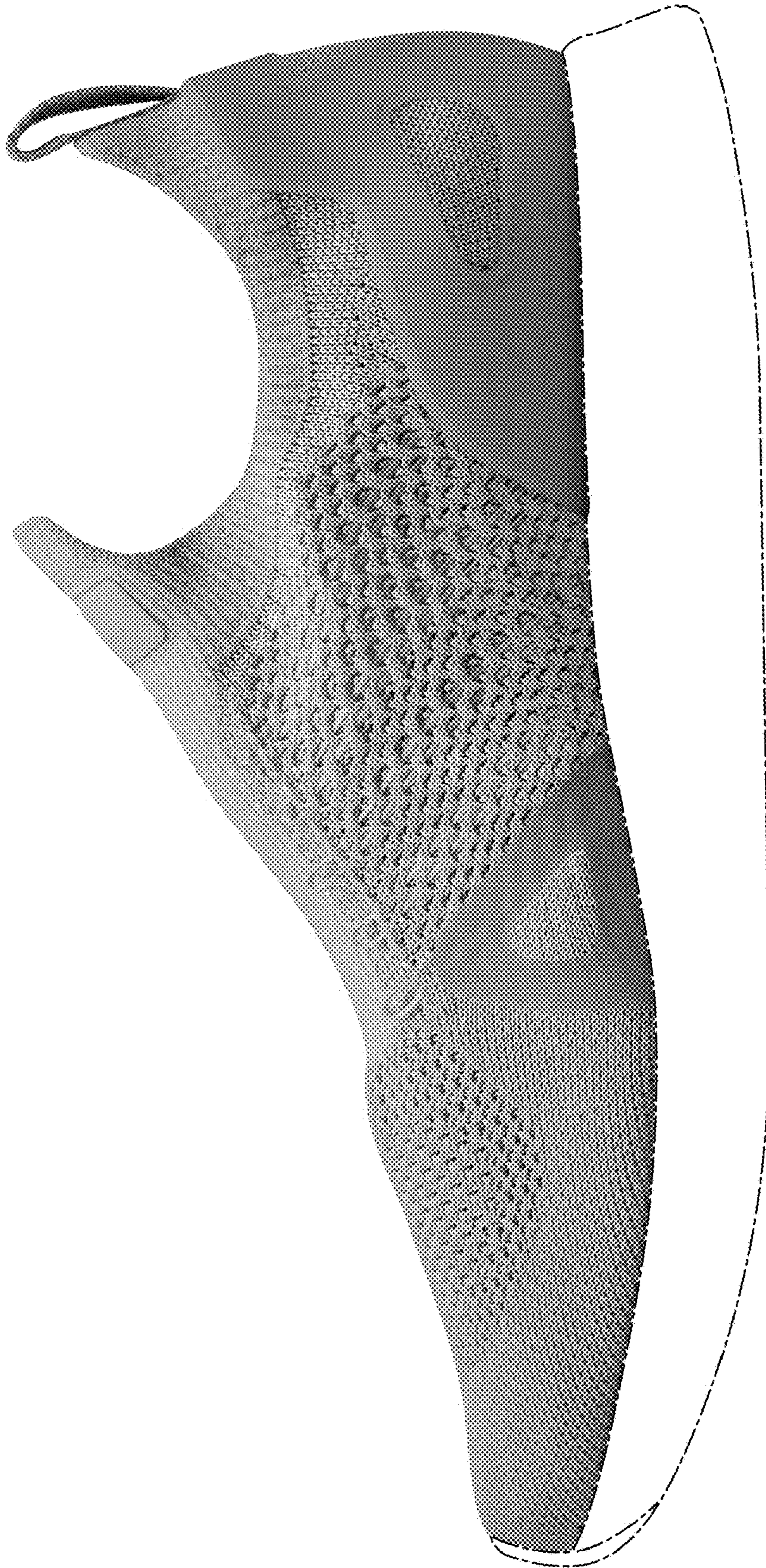

FIG. 2

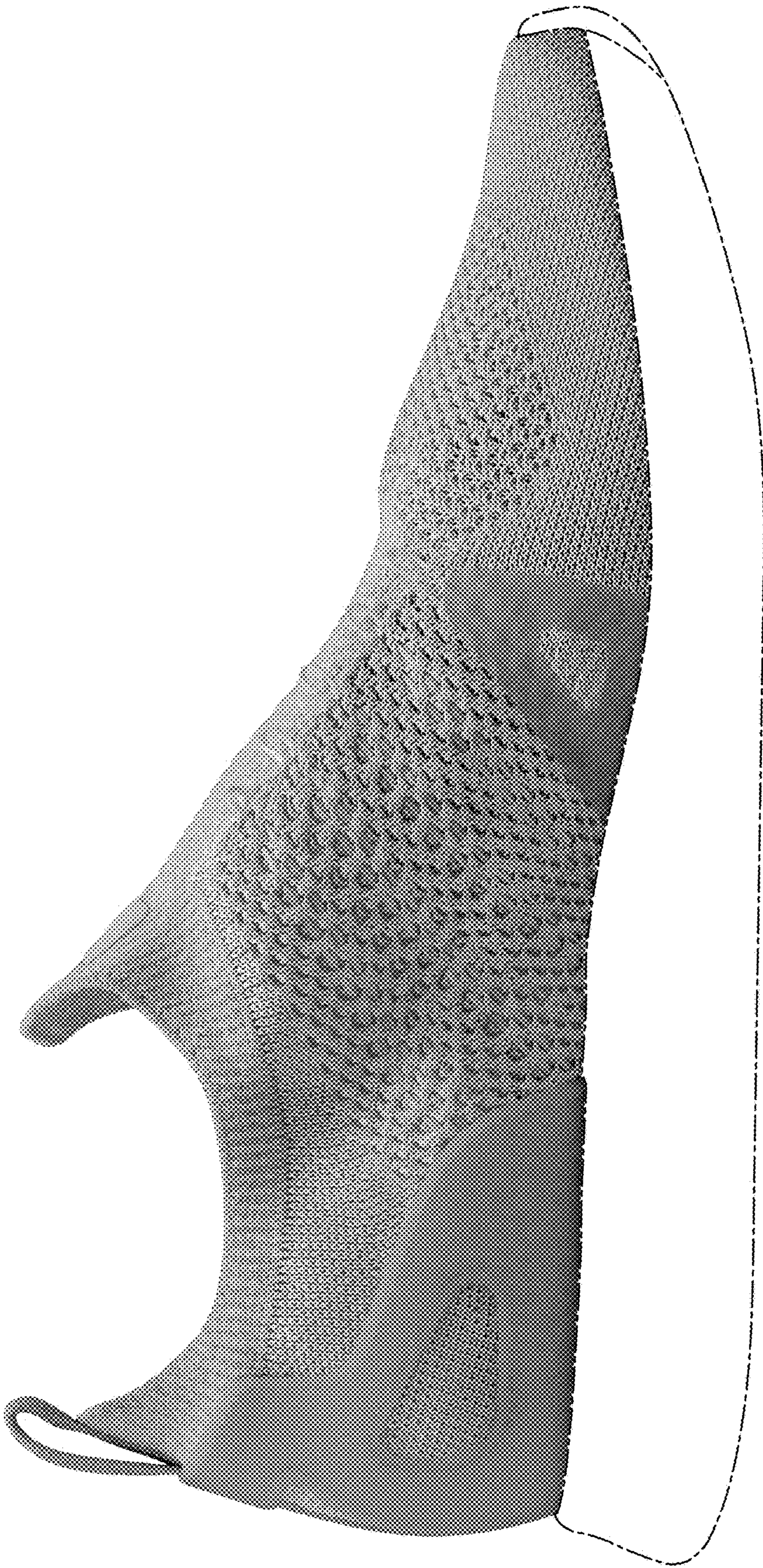

FIG. 3

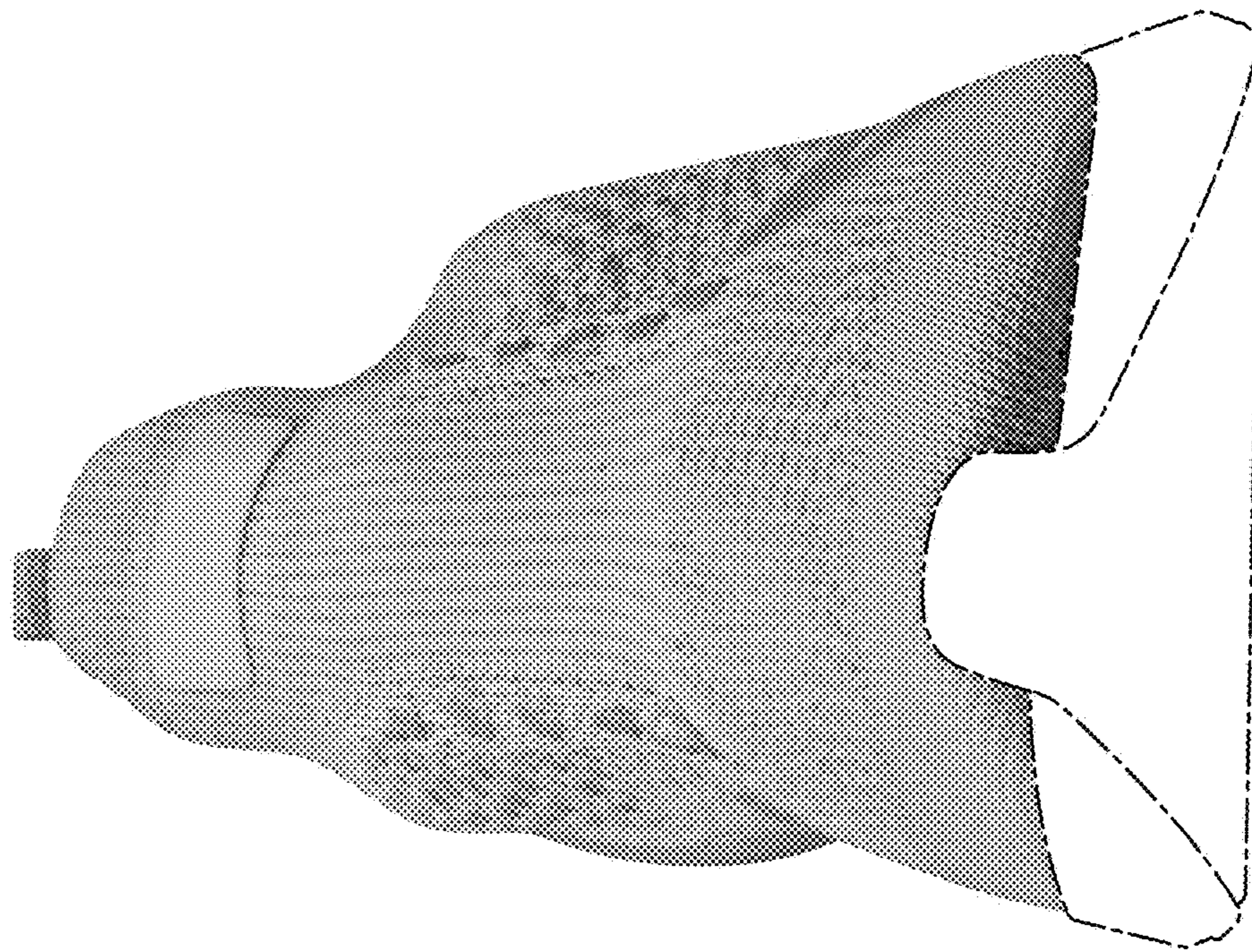

FIG. 4

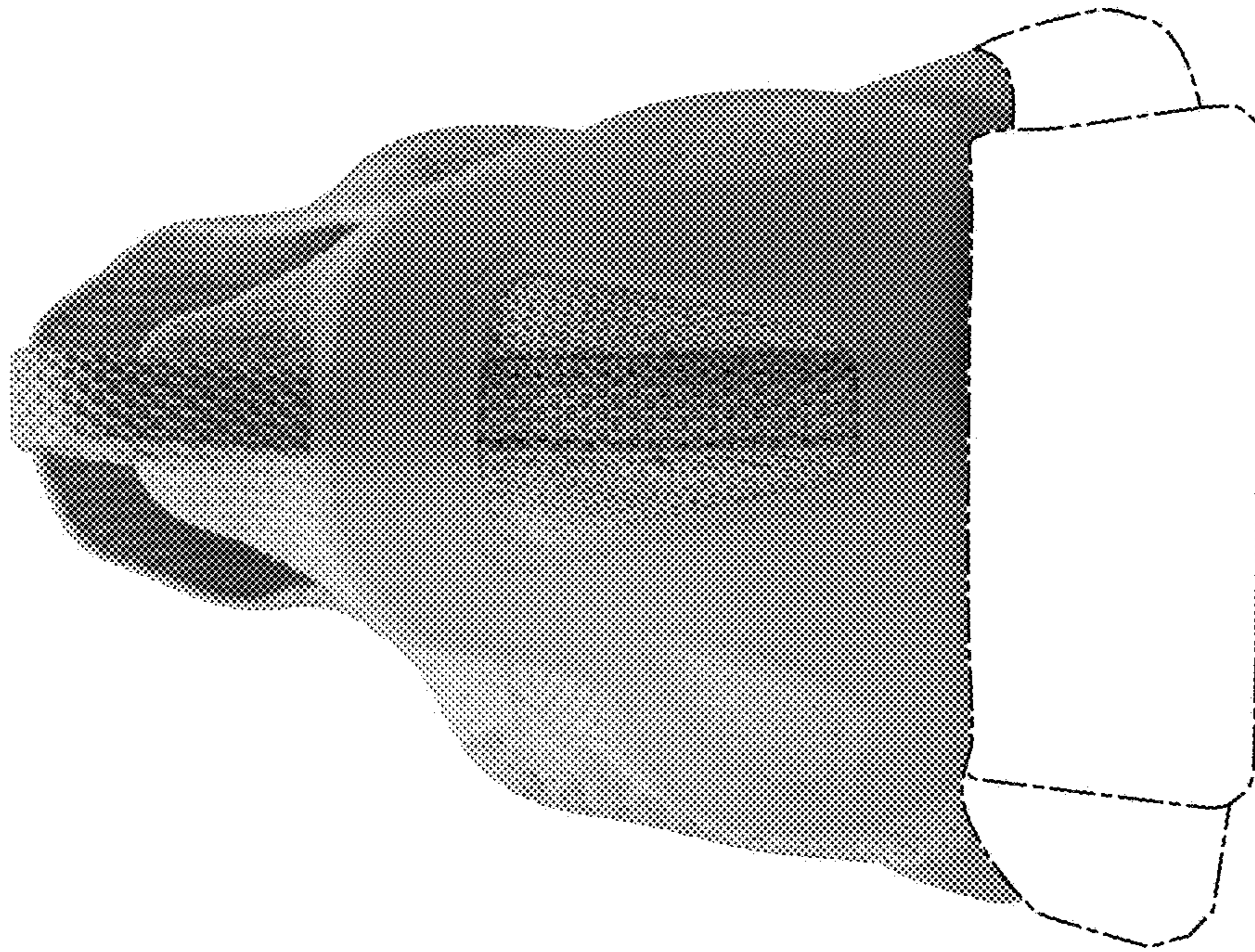

FIG. 5

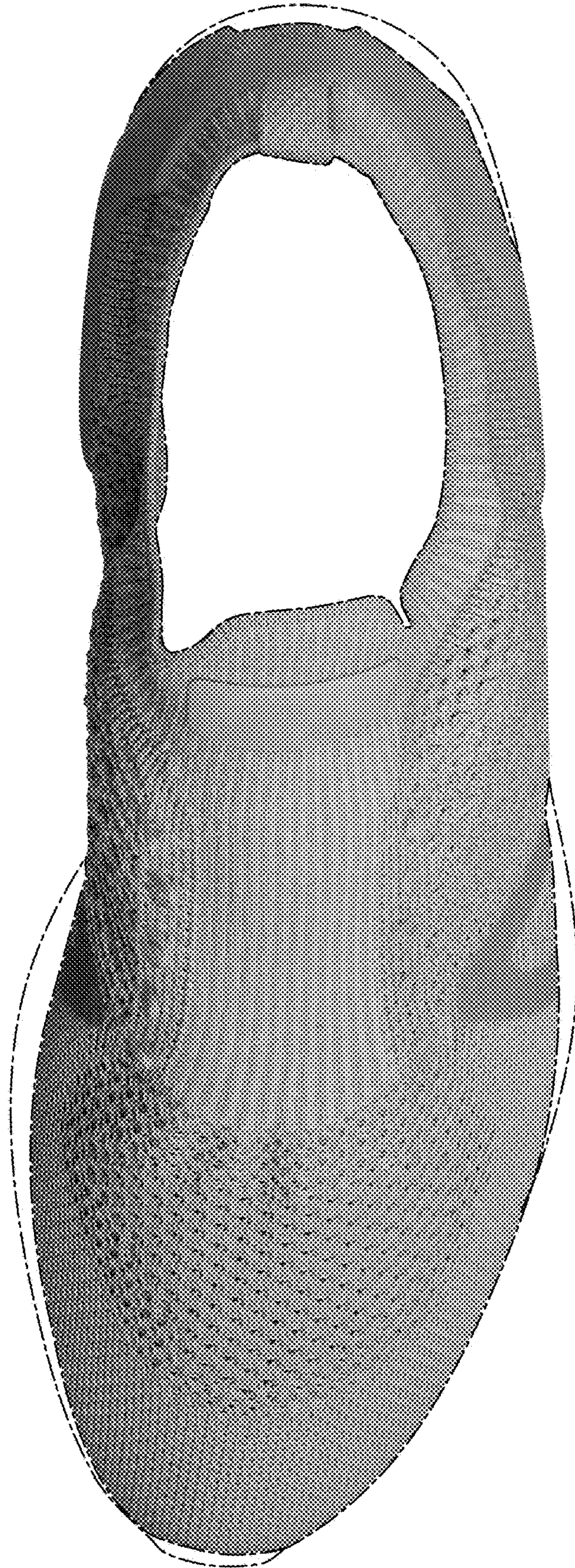

FIG. 6



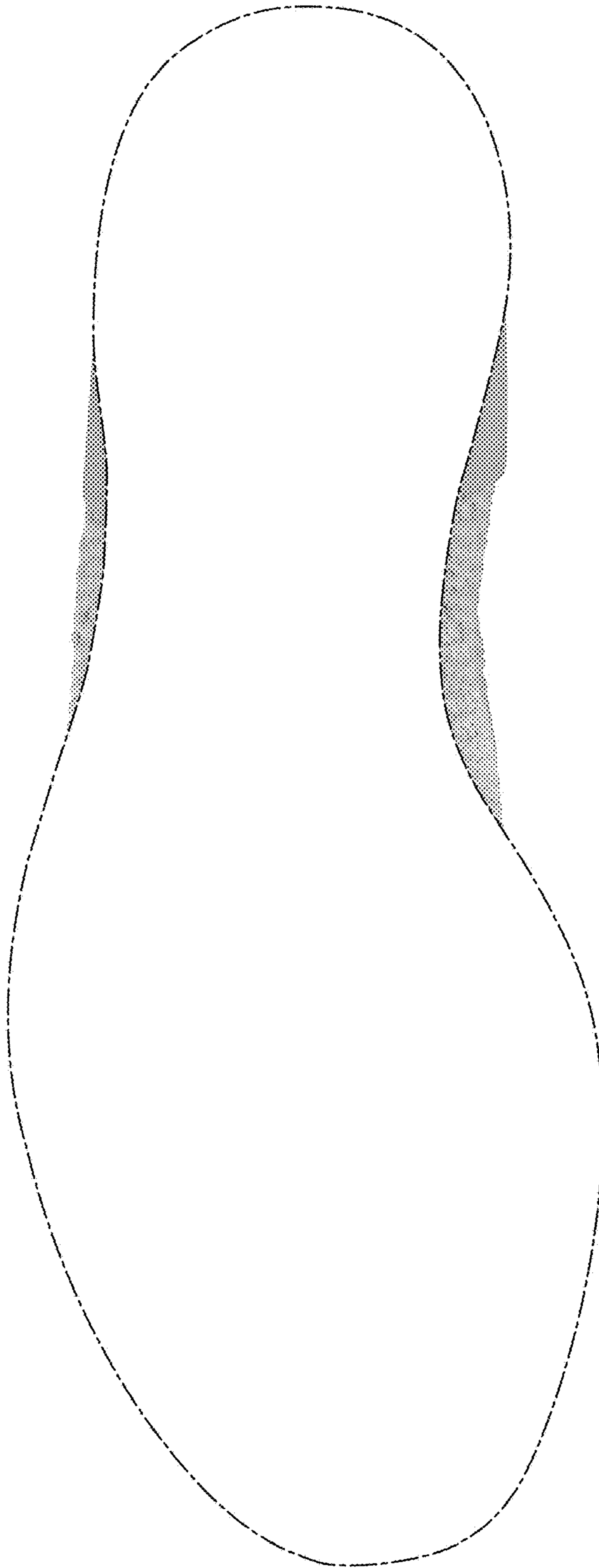

FIG. 7

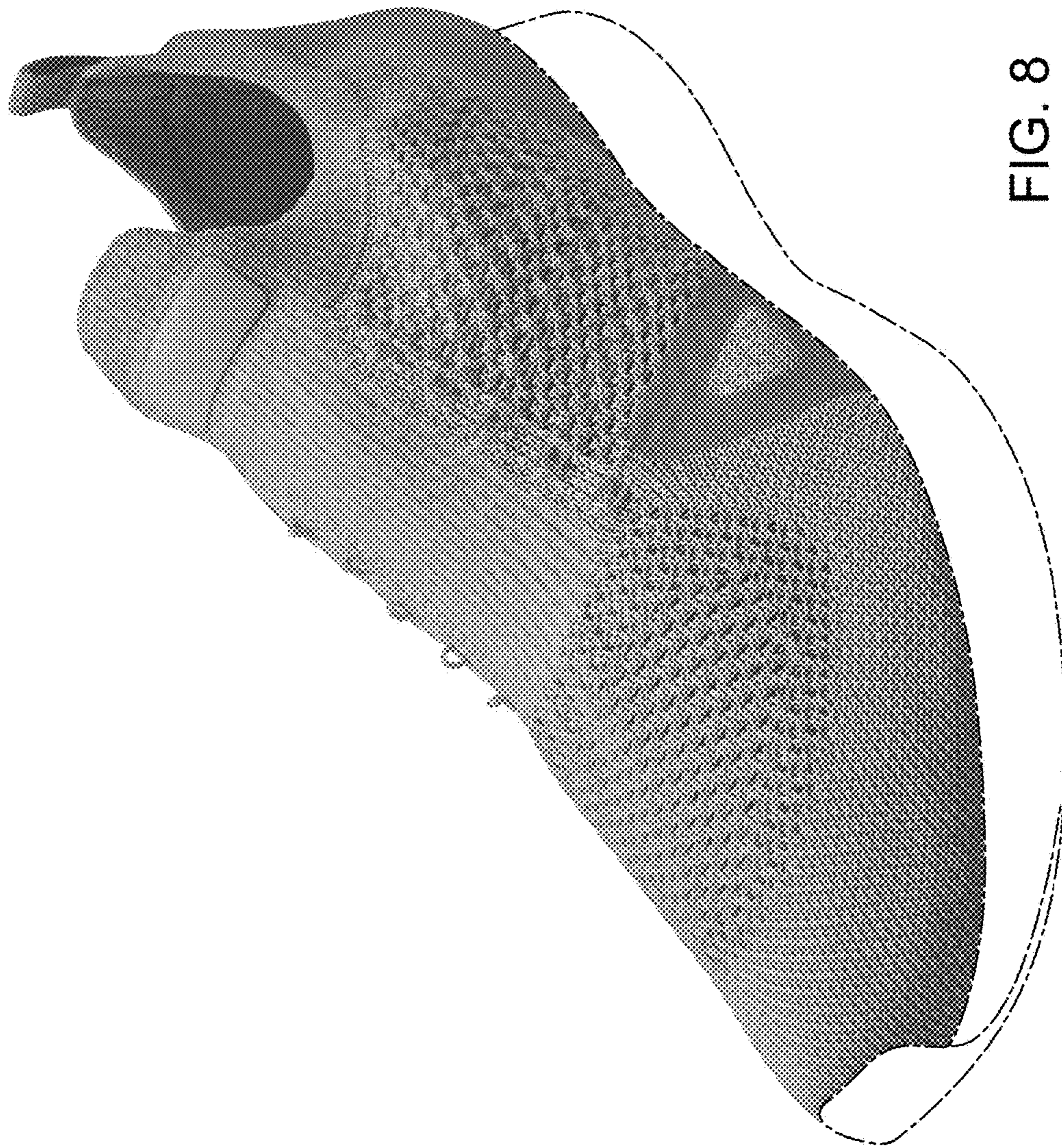

FIG. 8

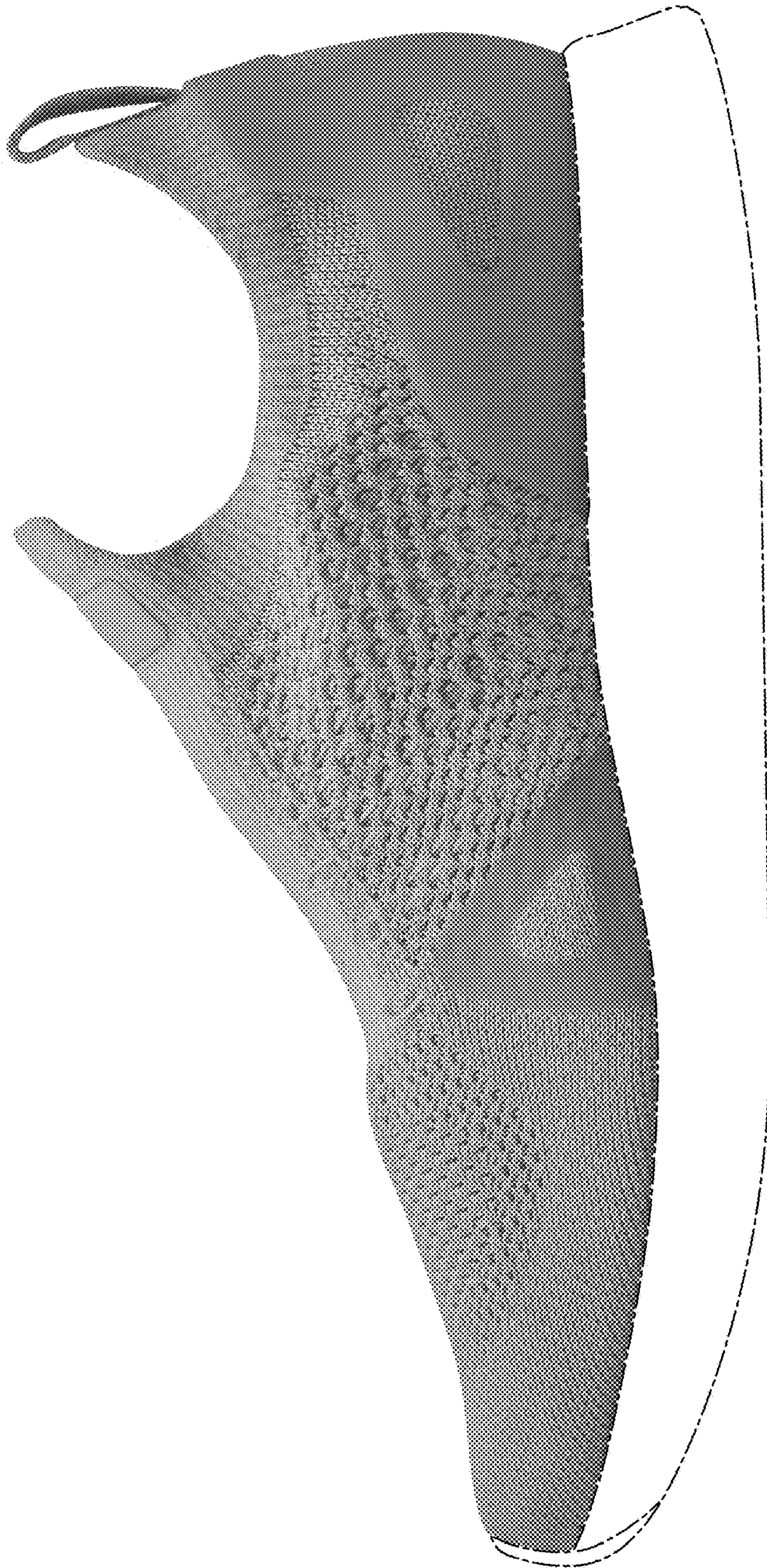

FIG. 9

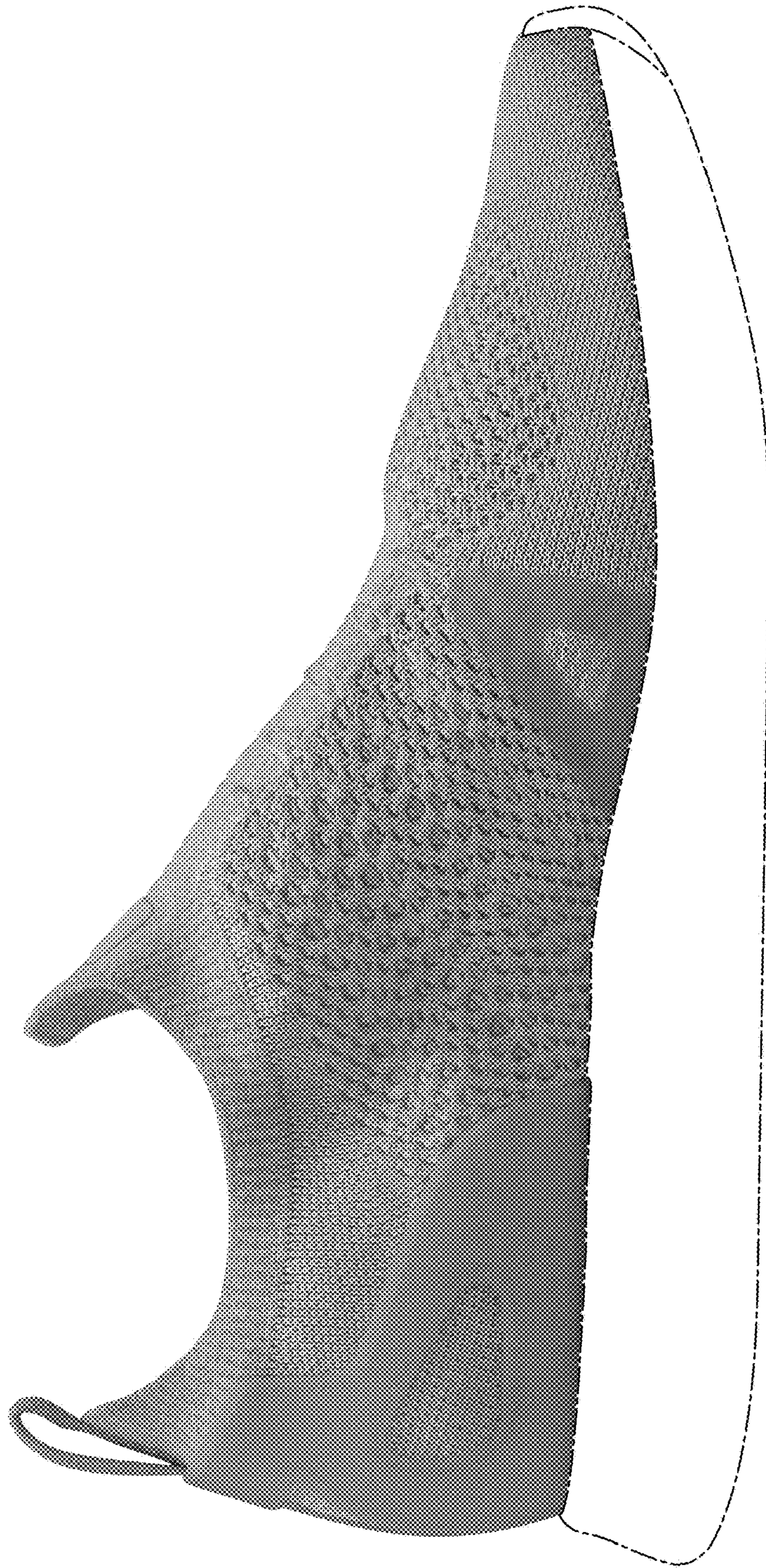

FIG. 10

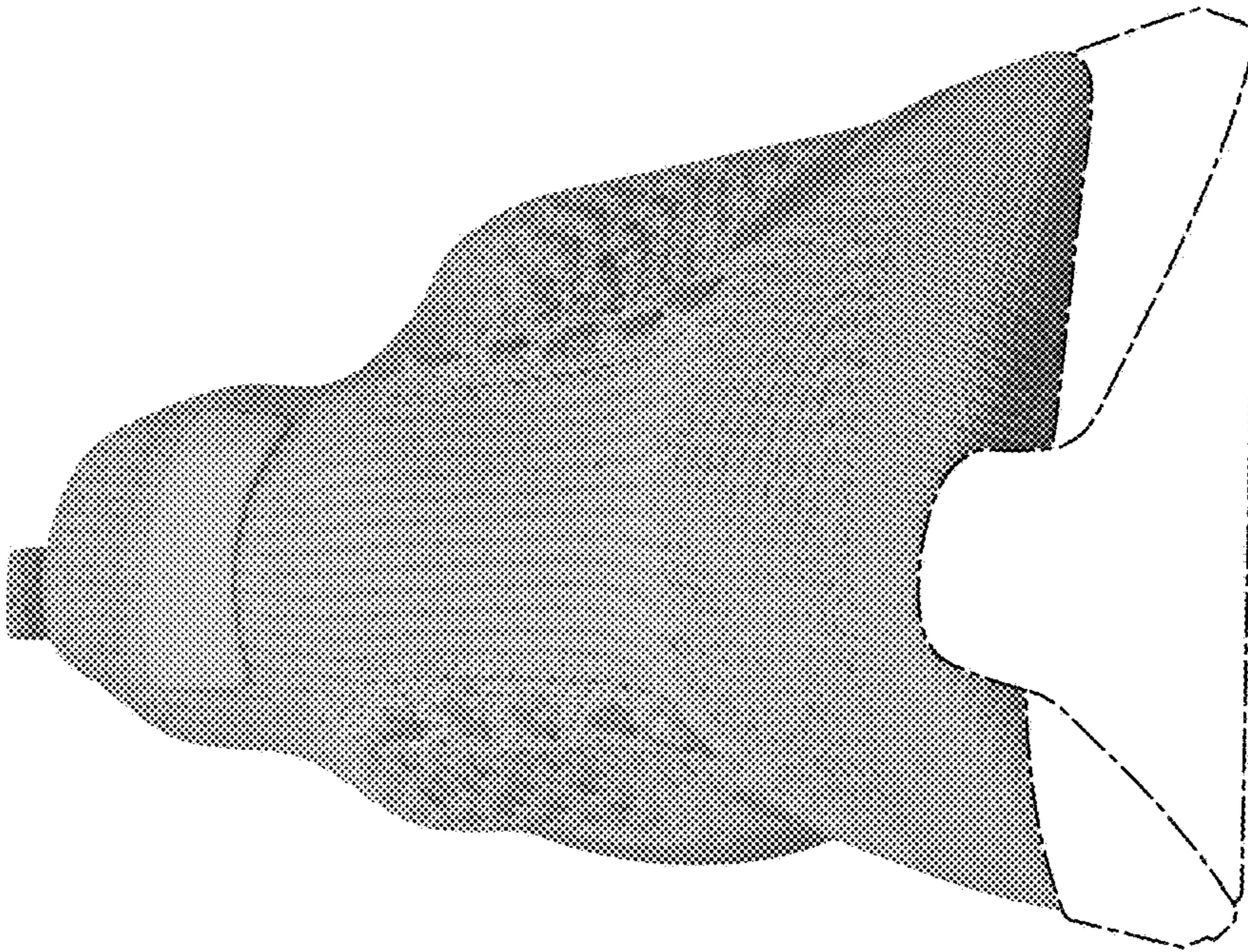

FIG. 11

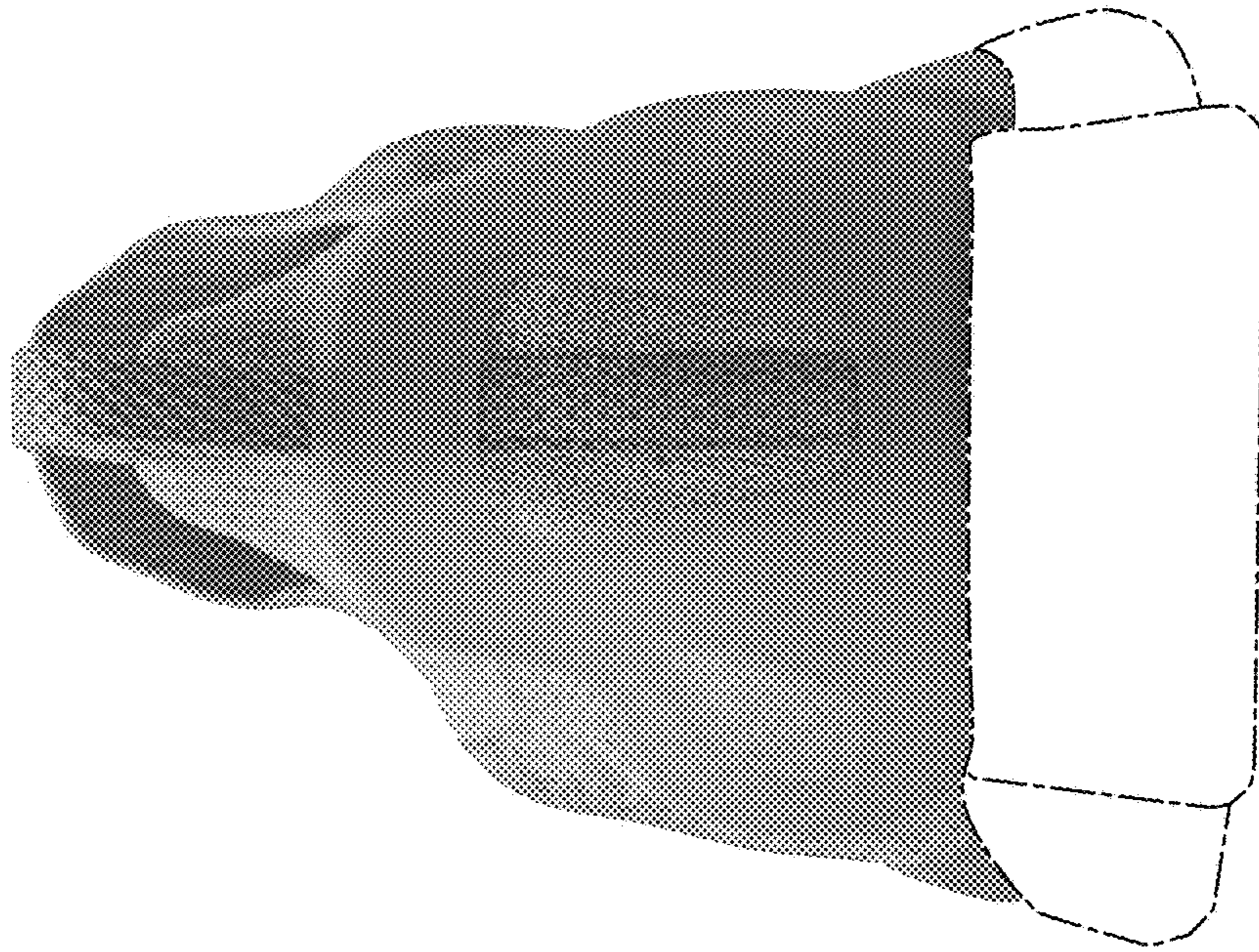

FIG. 12

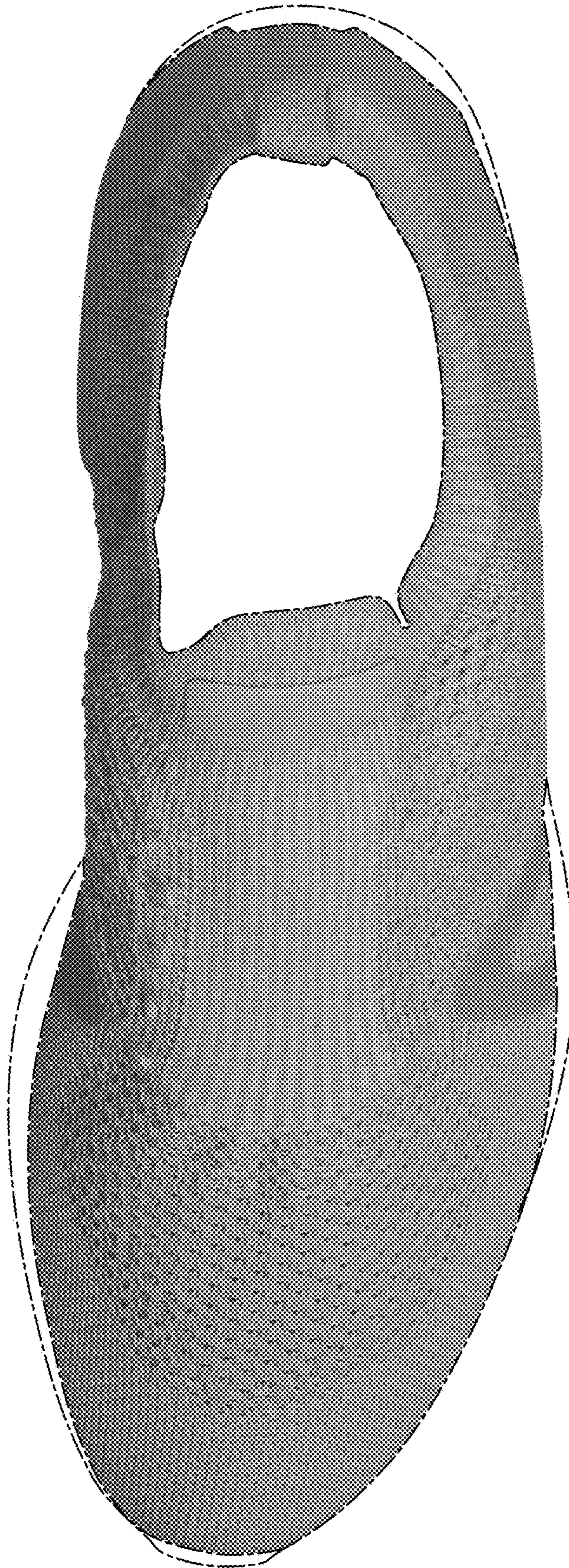

FIG. 13

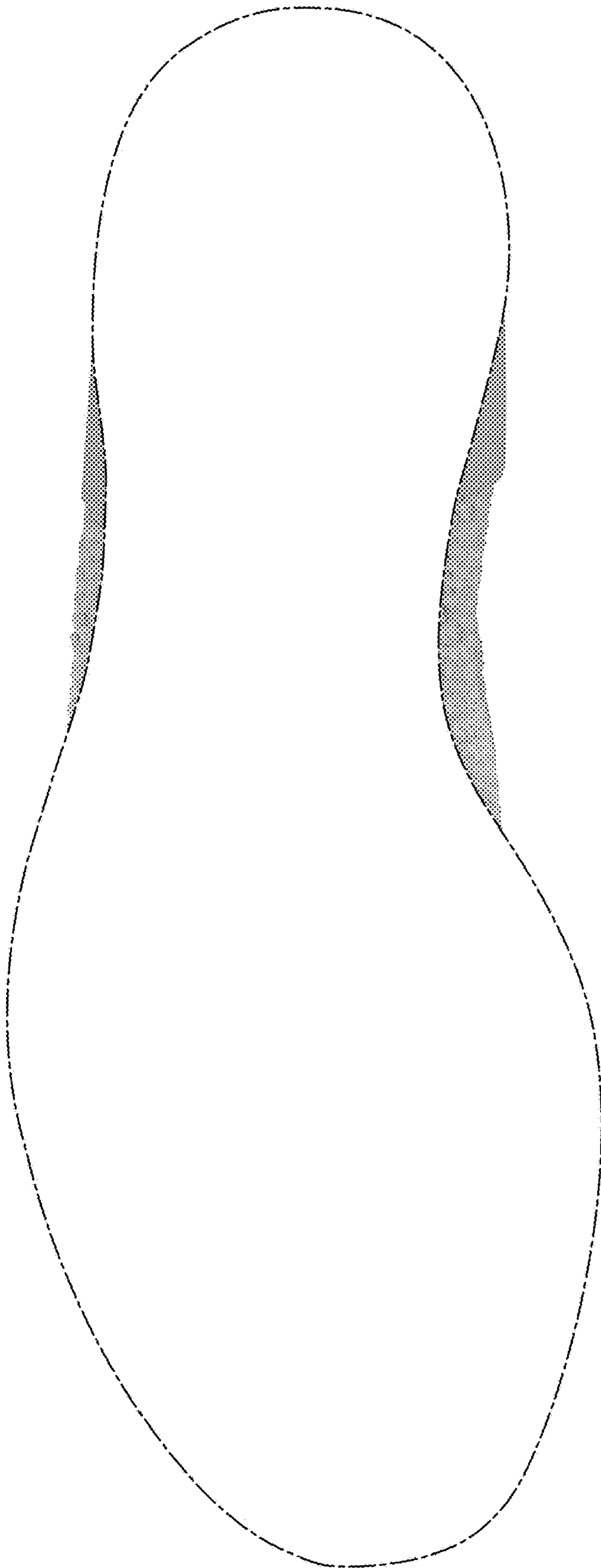

FIG. 14