



US00D834284S

(12) **United States Design Patent** (10) **Patent No.:** **US D834,284 S**
Picot (45) **Date of Patent:** **** Nov. 27, 2018**

(54) **PANTS**

(71) Applicant: **Bimla Picot**, New York, NY (US)

(72) Inventor: **Bimla Picot**, New York, NY (US)

(73) Assignee: **Bimla Picot**, New York, NY (US)

(**) Term: **15 Years**

(21) Appl. No.: **29/575,161**

(22) Filed: **Aug. 23, 2016**

Related U.S. Application Data

(63) Continuation-in-part of application No. 14/333,250, filed on Jul. 16, 2014.

(51) **LOC (11) Cl.** **02-02**

(52) **U.S. Cl.**
USPC **D2/742; D2/731**

(58) **Field of Classification Search**
USPC **D2/731, 742; 2/227**
CPC . **A41D 1/00; A41D 1/067; A41D 1/08; A41D 15/02; A41D 15/05; A41C 1/06**
See application file for complete search history.

(56) **References Cited**

U.S. PATENT DOCUMENTS

1,489,046	A	4/1924	Thompson	
3,276,036	A	10/1966	Cater	
4,766,613	A *	8/1988	Wells A41D 15/002 2/227
4,995,115	A	2/1991	Ellis	
5,097,535	A	3/1992	Dye	

(Continued)

Primary Examiner — Robin V Webster

Assistant Examiner — J. Thorn, Sr.

(74) *Attorney, Agent, or Firm* — Dority & Manning, P.A.

(57) **CLAIM**

The ornamental design for pants, as shown and described.

DESCRIPTION

FIG. 1 is a front view of a pair of pants showing my new design;

FIG. 2 is an enlarged front view of the waistband of the pants;

FIG. 3 is a front view of the pants with the pockets spread open;

FIG. 4 is a right view of the pants;

FIG. 5 is a right view of the pants with the upper leg zipper partially unzipped from the knee portion;

FIG. 6 is a front view of the pants with the knee zippers fully unzipped;

FIG. 7 is a right view of the pants with the lower leg zipper partially unzipped;

FIG. 8 is a front view of the pants with the right lower leg zipper fully unzipped;

FIG. 9 is a front view of the pants with the upper leg zippers unzipped from their respective knee portions to the waistband, the knee zippers fully unzipped, and the lower leg zippers fully unzipped;

FIG. 10 is a front view of the upper portion of the pants with the knee zippers fully unzipped, the lower leg portions removed, and the upper leg zippers unzipped from their respective knee portions to the waistband;

FIG. 11 is a front view of the pants with the knee zippers fully unzipped and the upper leg zippers partially unzipped from the waistband;

FIG. 12 is a front view of the pants with the knee zippers full unzipped and the upper leg zippers undone from the waistband and respective knee portions;

FIG. 13 is a rear view of the pants;

FIG. 14 is an enlarged front view of the left pocket on the front of the pants;

FIG. 15 is a top view of the pants; and,

FIG. 16 is a bottom view of the pants.

The broken lines are illustrative only and form no part of the claimed design.

1 Claim, 15 Drawing Sheets

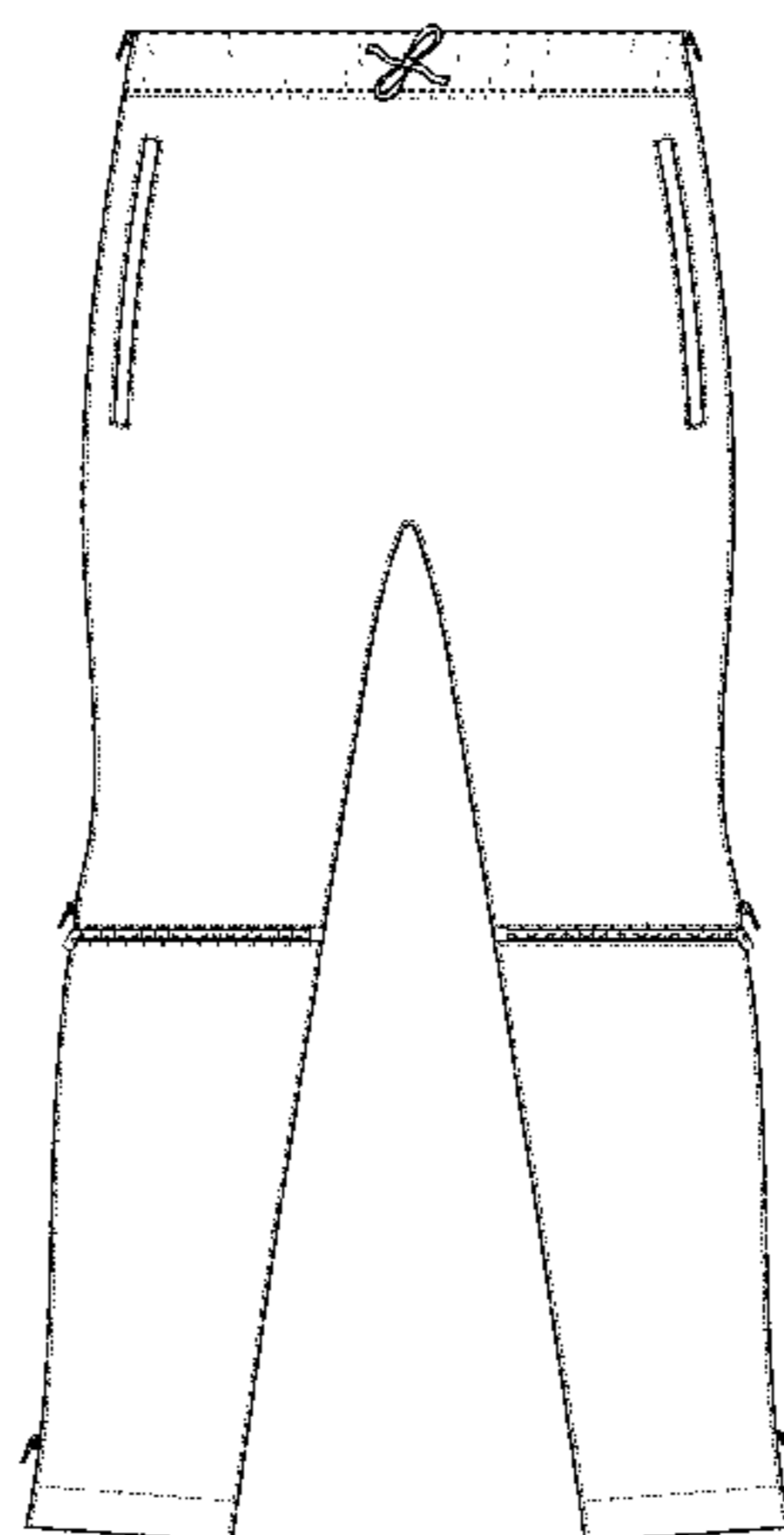

(56)

References Cited

U.S. PATENT DOCUMENTS

5,553,323	A	9/1996	Chou et al.	
5,564,123	A	10/1996	Grassick	
5,564,126	A	10/1996	Chou	
5,592,691	A	1/1997	Ronald	
5,717,999	A	2/1998	Lurry	
5,822,802	A	10/1998	Chou	
5,864,888	A *	2/1999	Archer	A41D 1/082 2/227
5,887,279	A	3/1999	Elting et al.	
6,647,552	B1	11/2003	Hogan	
6,792,621	B2	9/2004	Braun	
D513,660	S *	1/2006	Greene	D2/742
D530,885	S	10/2006	Barthel	
8,161,573	B1	4/2012	Burns-Cox	
D683,522	S *	6/2013	Pasloski	D2/731
D770,133	S *	11/2016	Burke	D2/731
D783,941	S *	4/2017	Suarez	D2/742
D793,664	S *	8/2017	Emanuel	D2/742
D802,257	S *	11/2017	Van Sisseren	D2/742
D802,258	S *	11/2017	Lomax	D2/742
D807,615	S *	1/2018	Huynh	D2/742
D822,949	S *	7/2018	Emanuel	D2/742
2007/0199127	A1	8/2007	Coronado	
2009/0031464	A1	2/2009	Luc Gorby	
2010/0017933	A1	1/2010	Taylor-Barry	
2012/0017348	A1	1/2012	Ellsworth	
2012/0117708	A1	5/2012	Trapani	
2013/0125287	A1 *	5/2013	Boyle	A41D 15/002 2/70

* cited by examiner

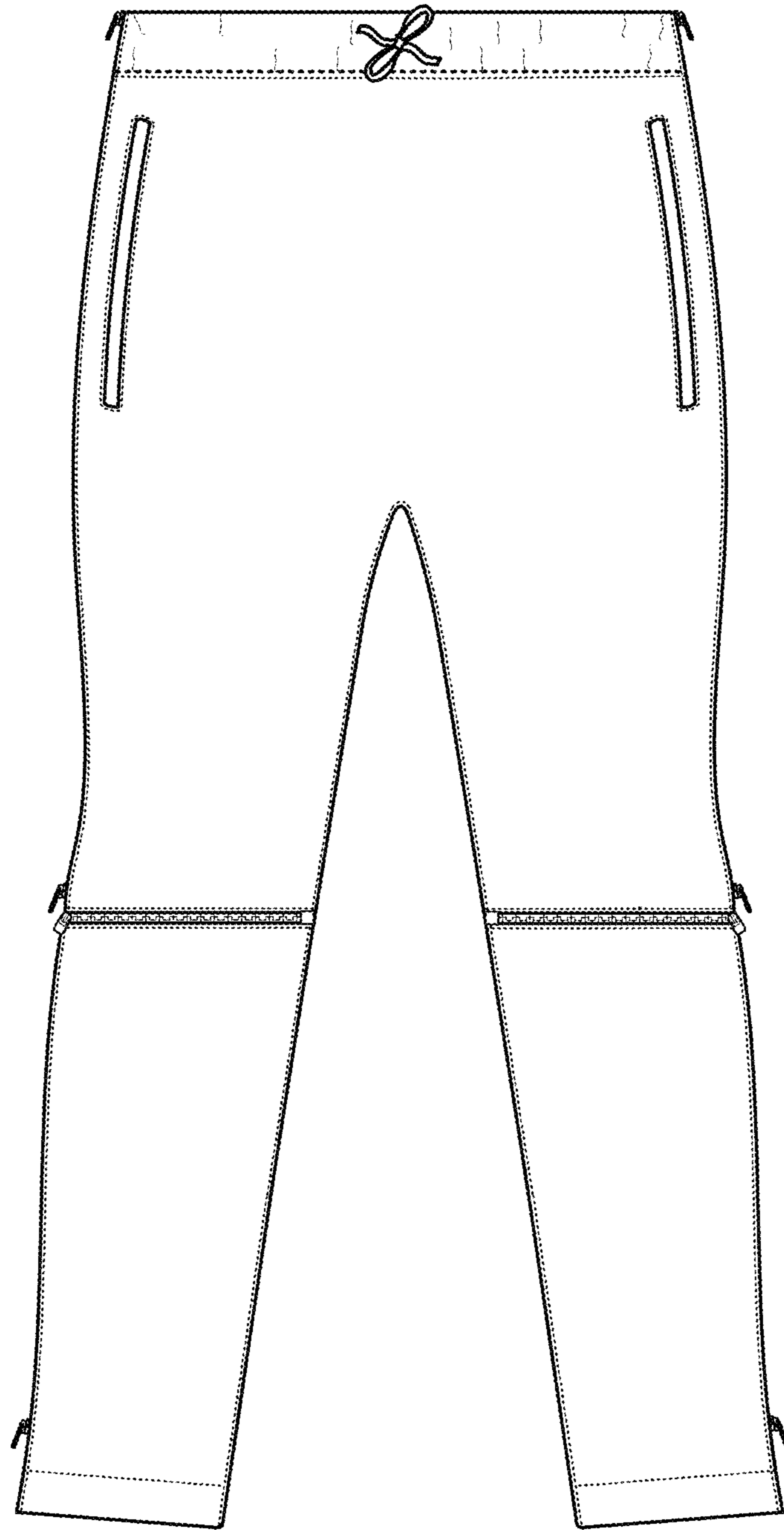

FIG. 1

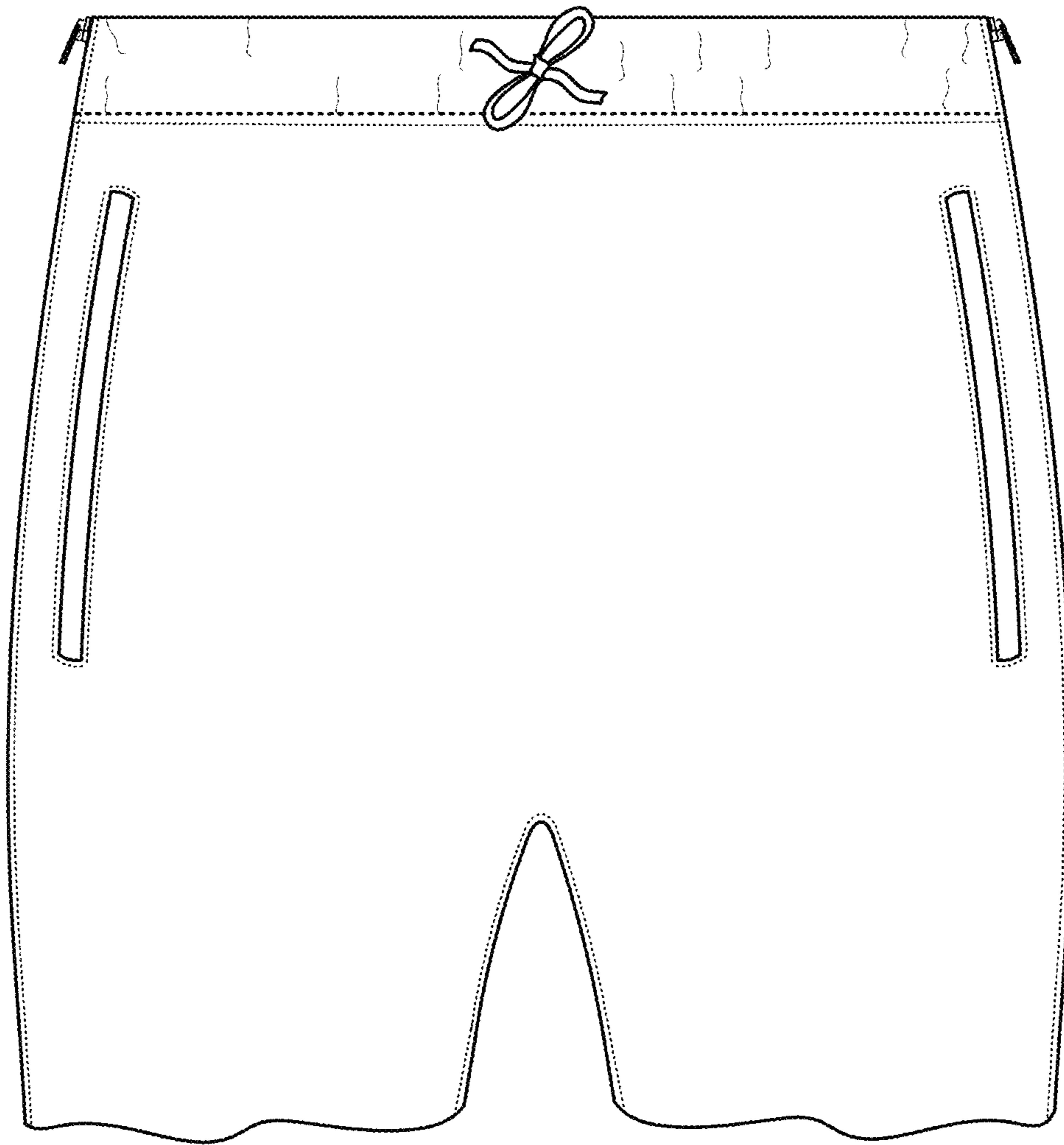

FIG. 2

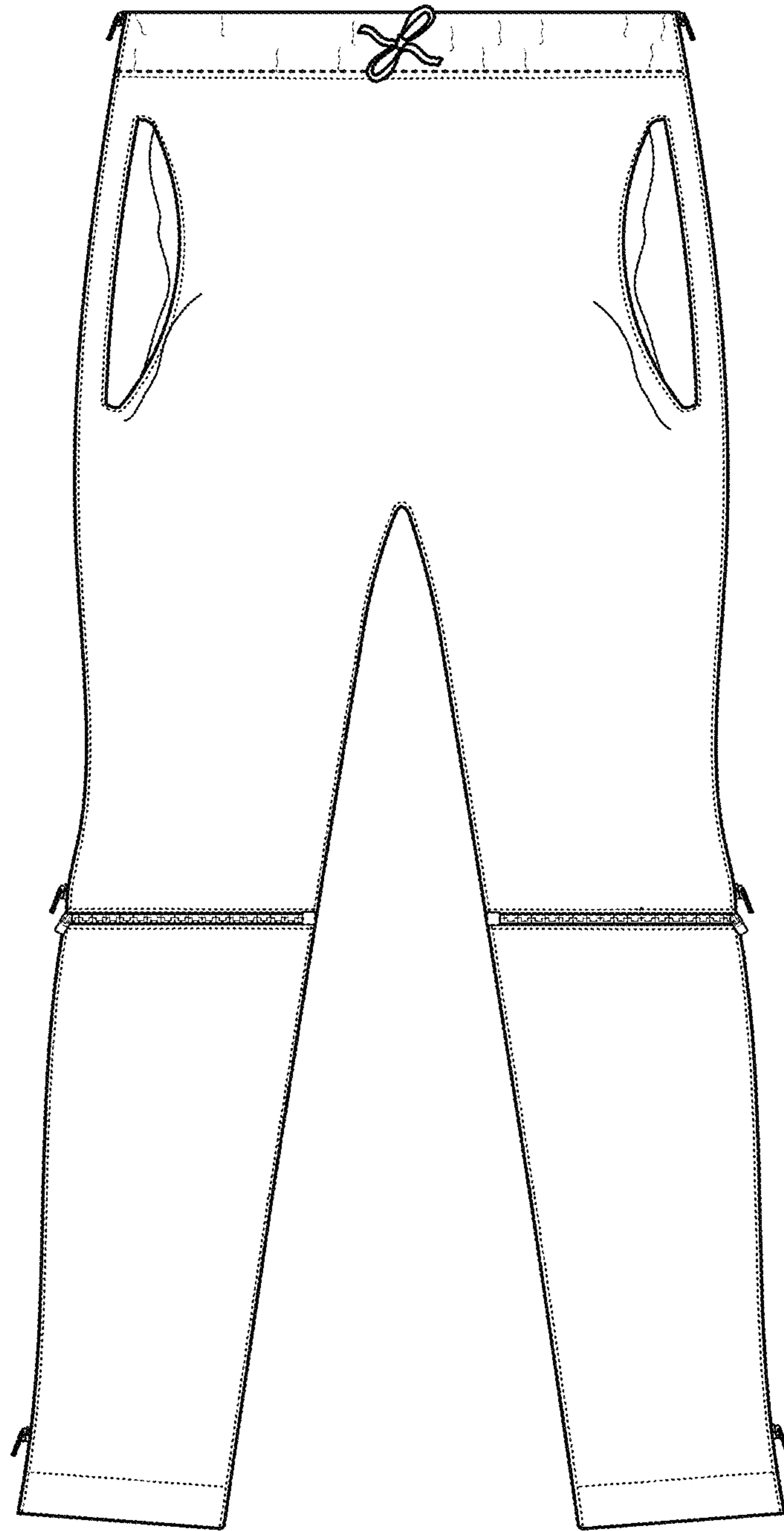

FIG. 3

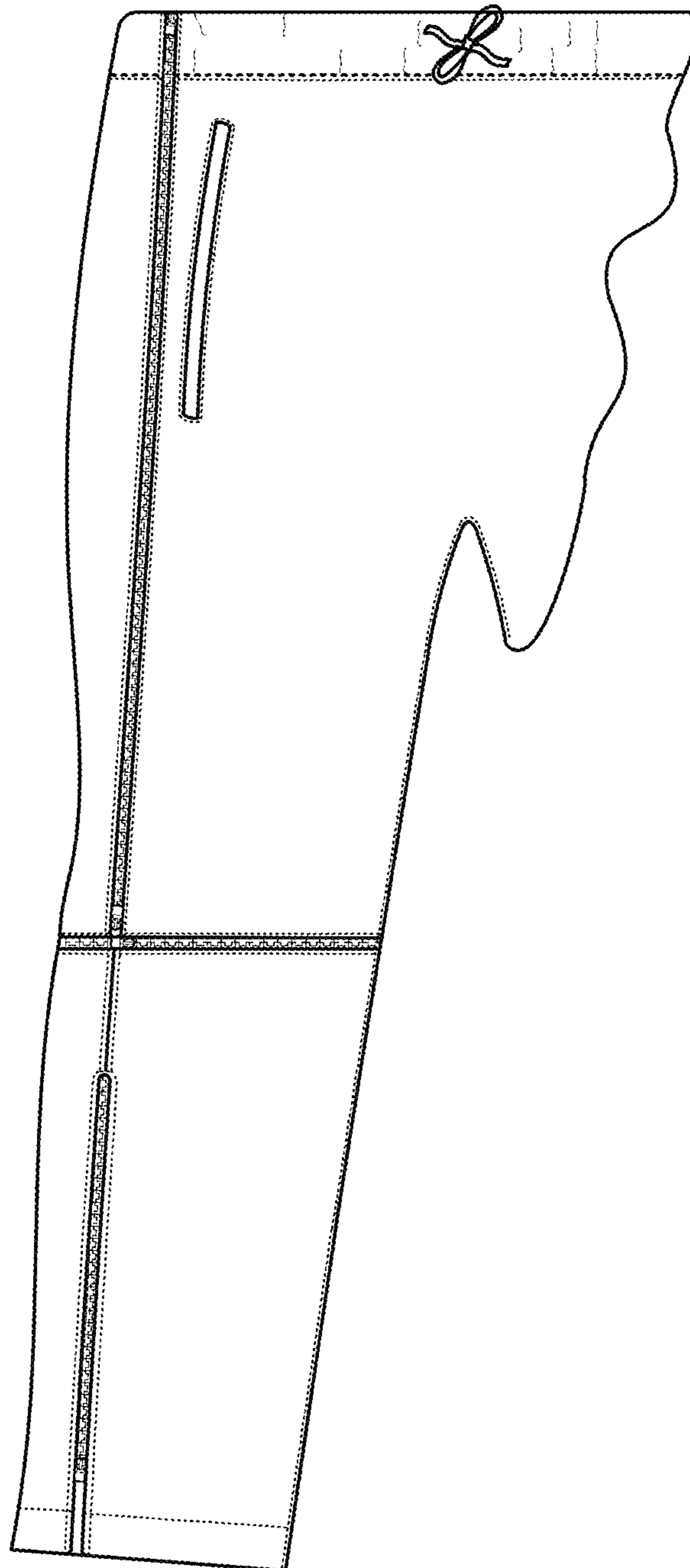

FIG. 4

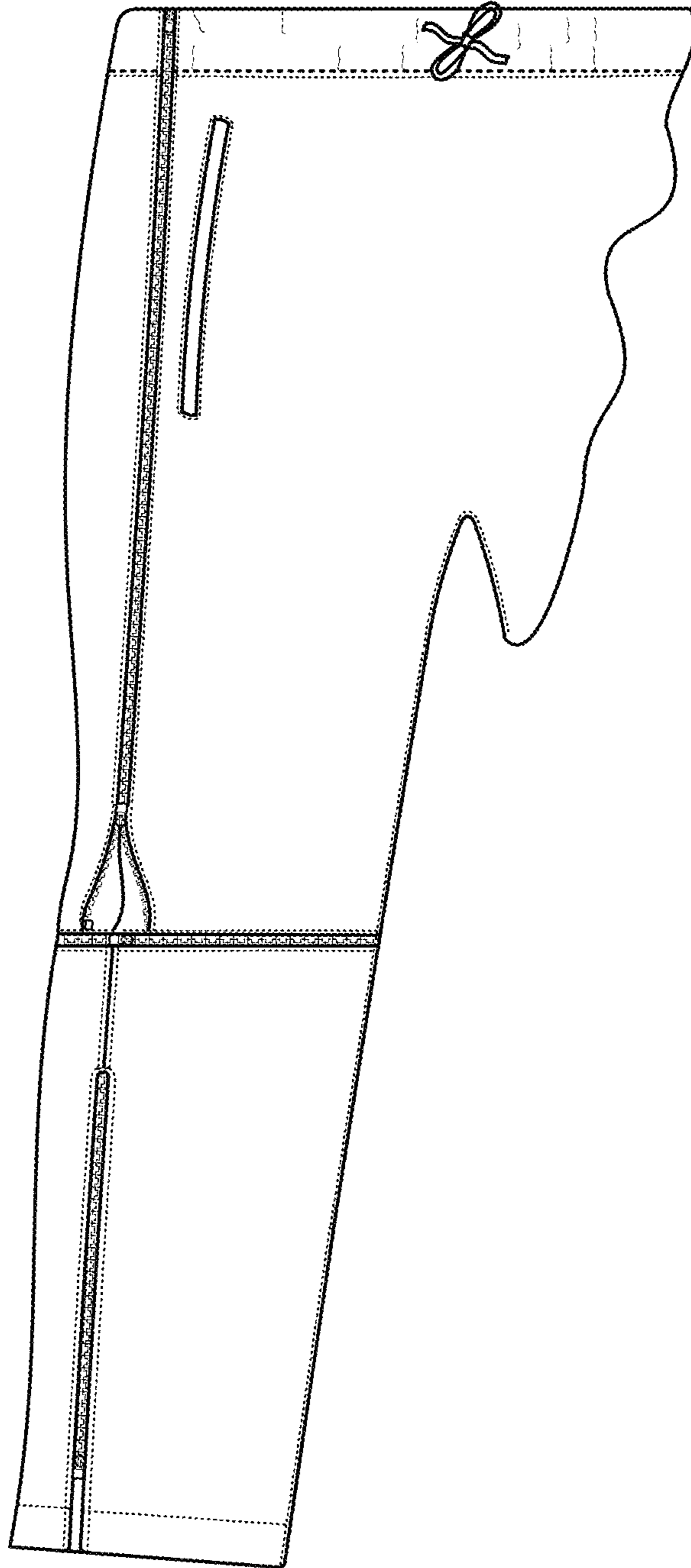

FIG. 5

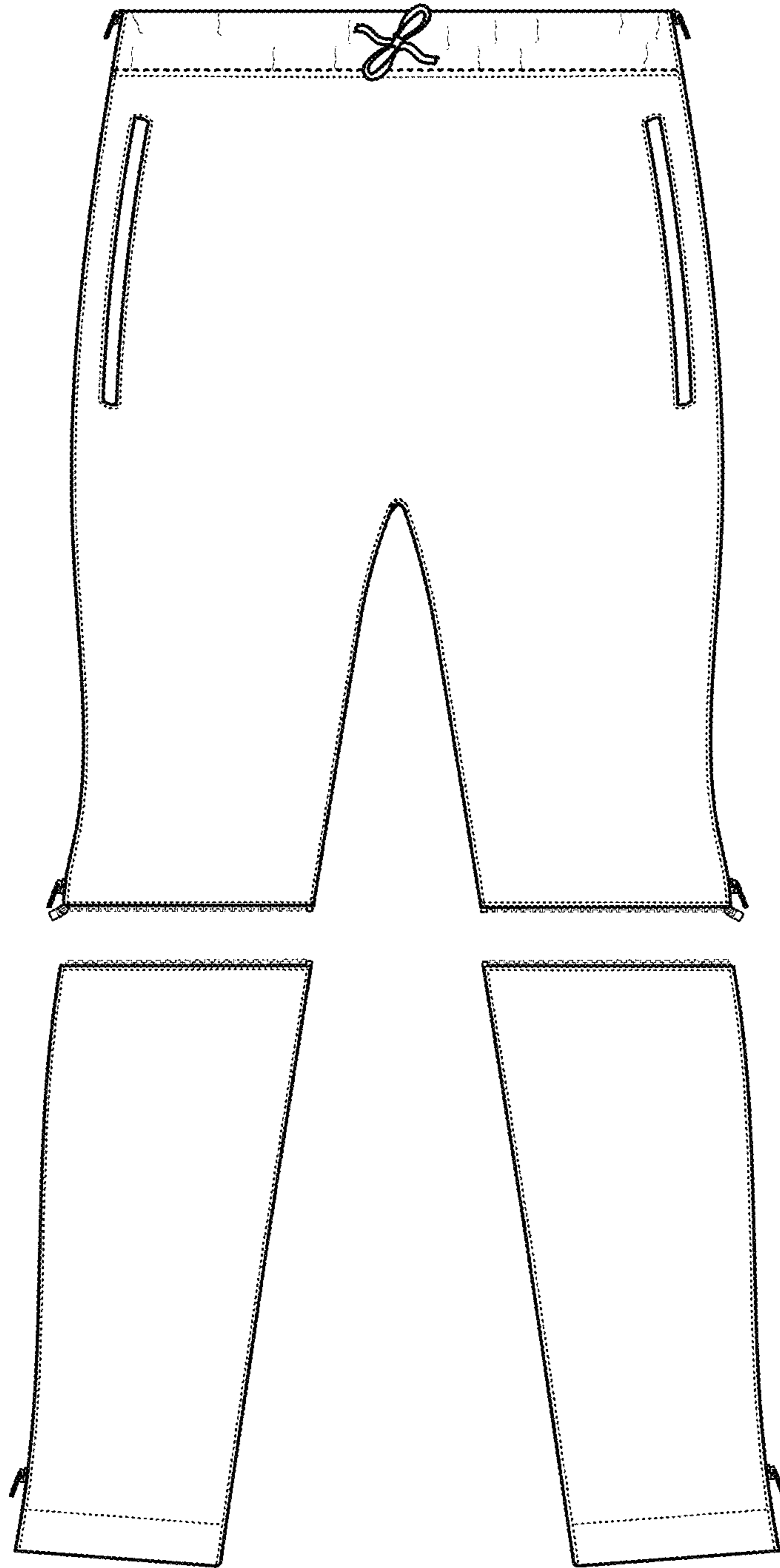

FIG. 6

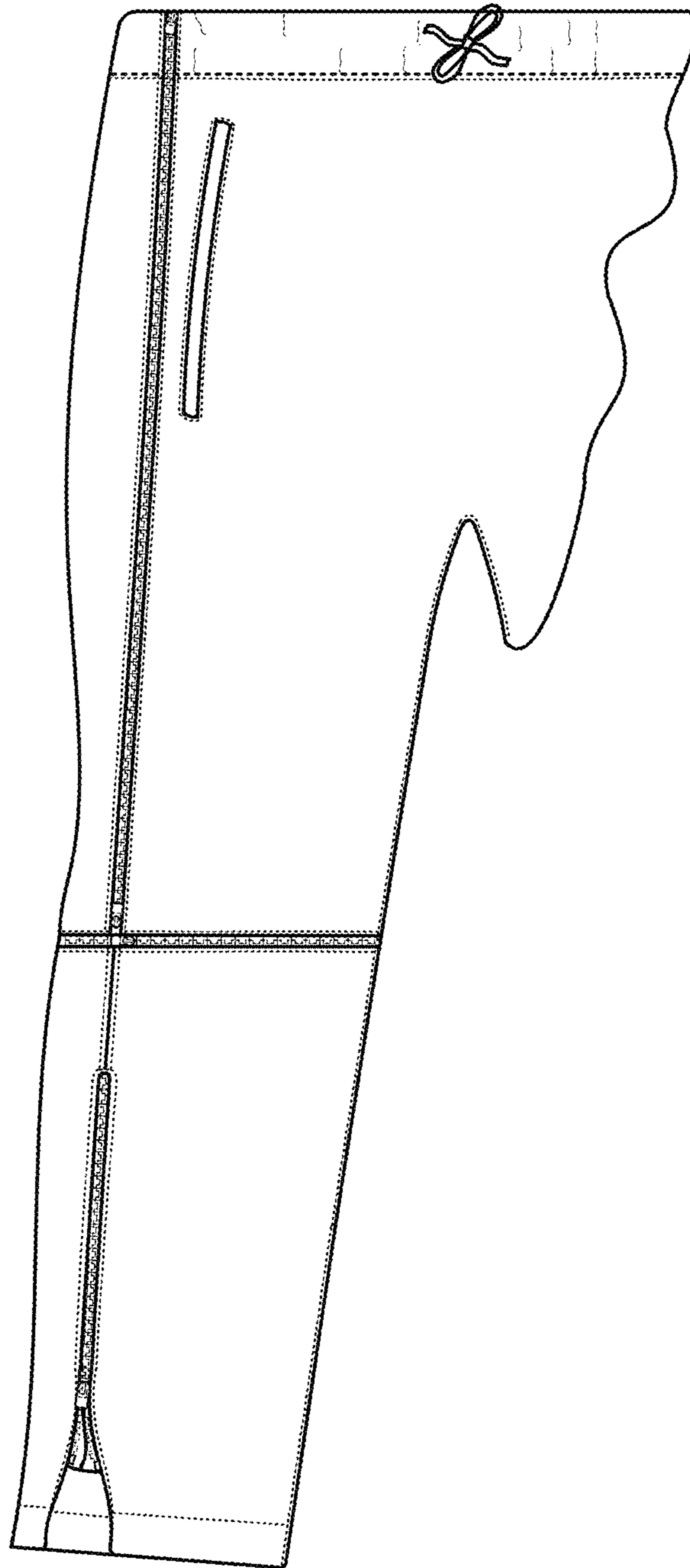

FIG. 7

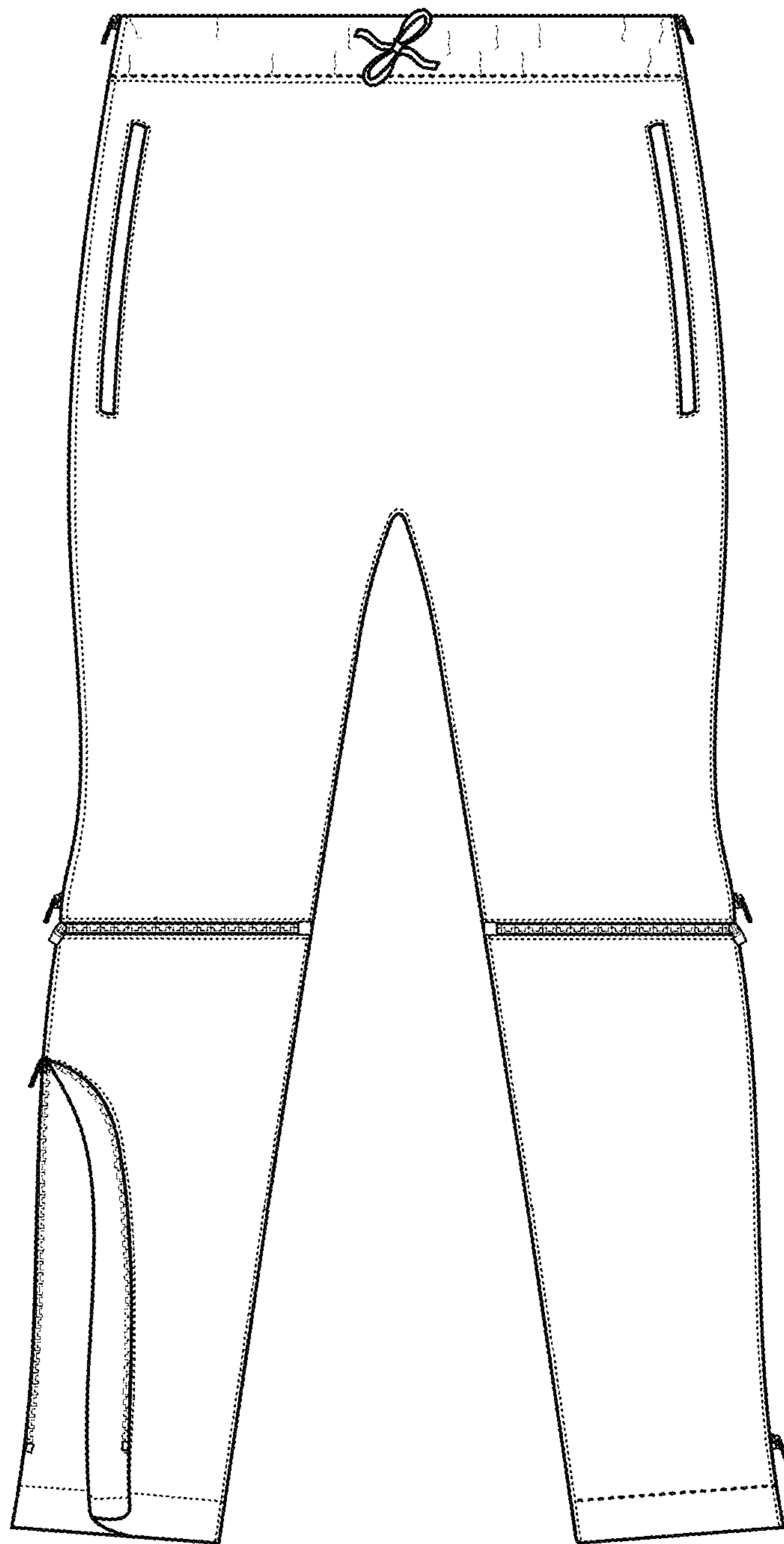

FIG. 8

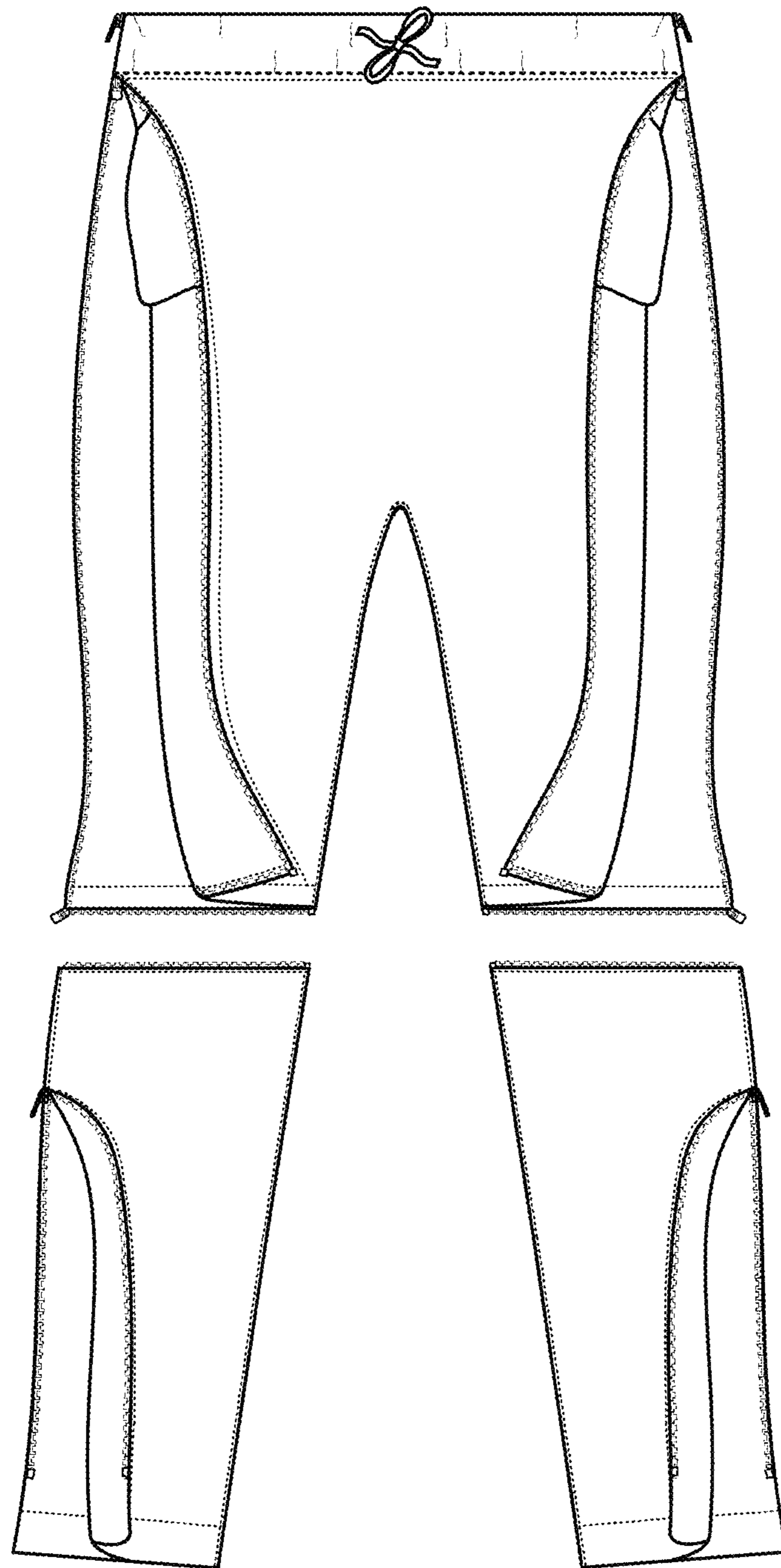

FIG. 9

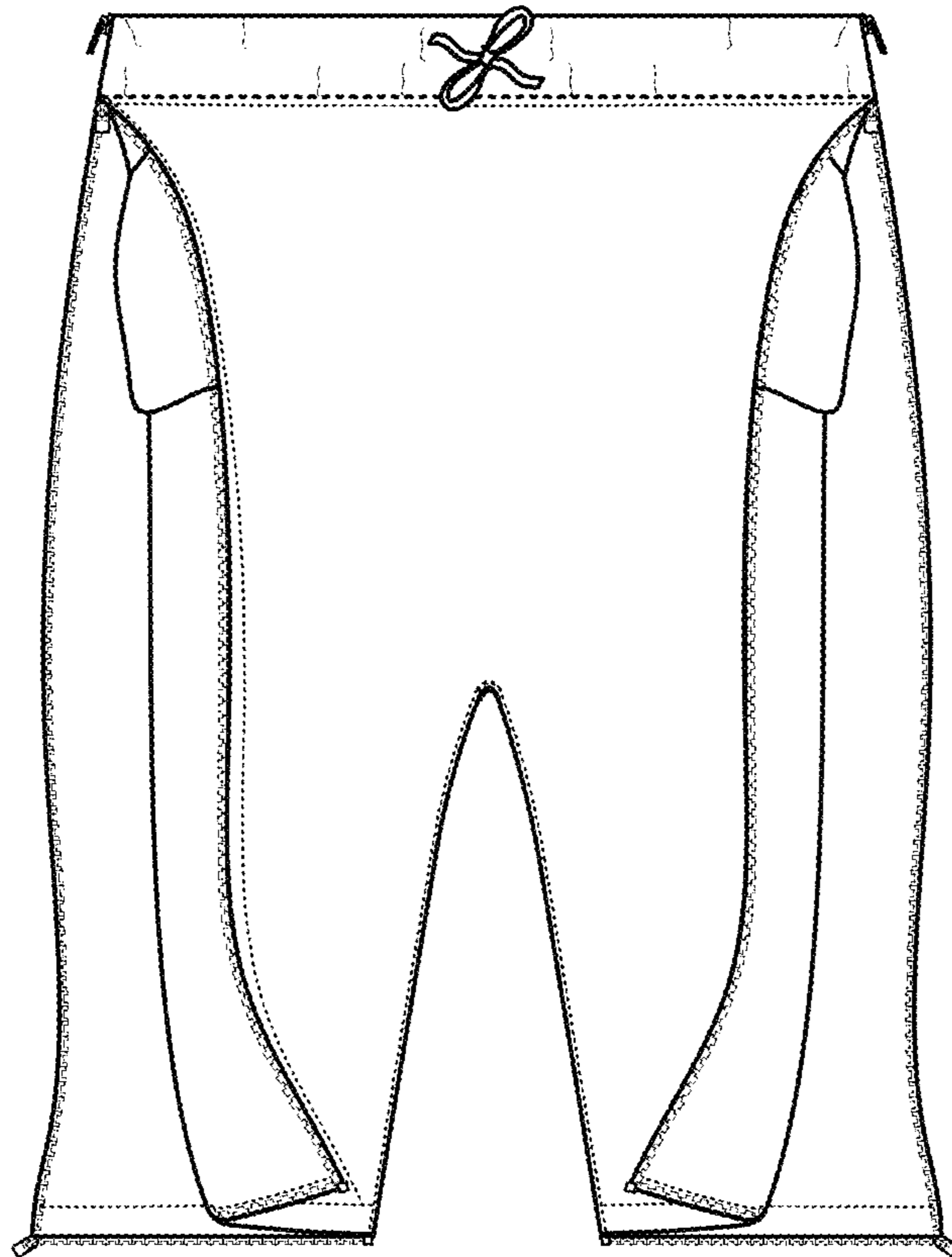

FIG. 10

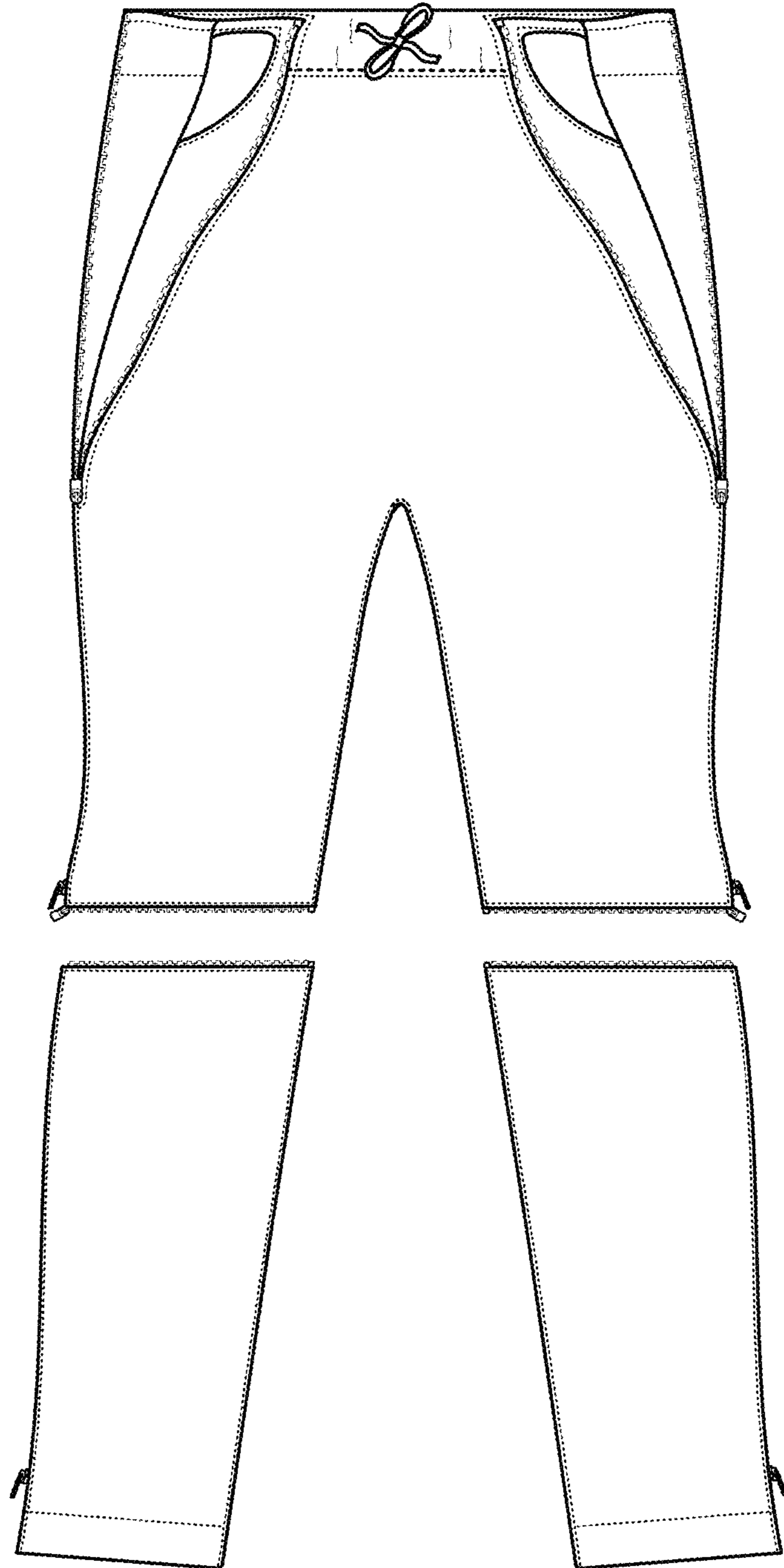

FIG. 11

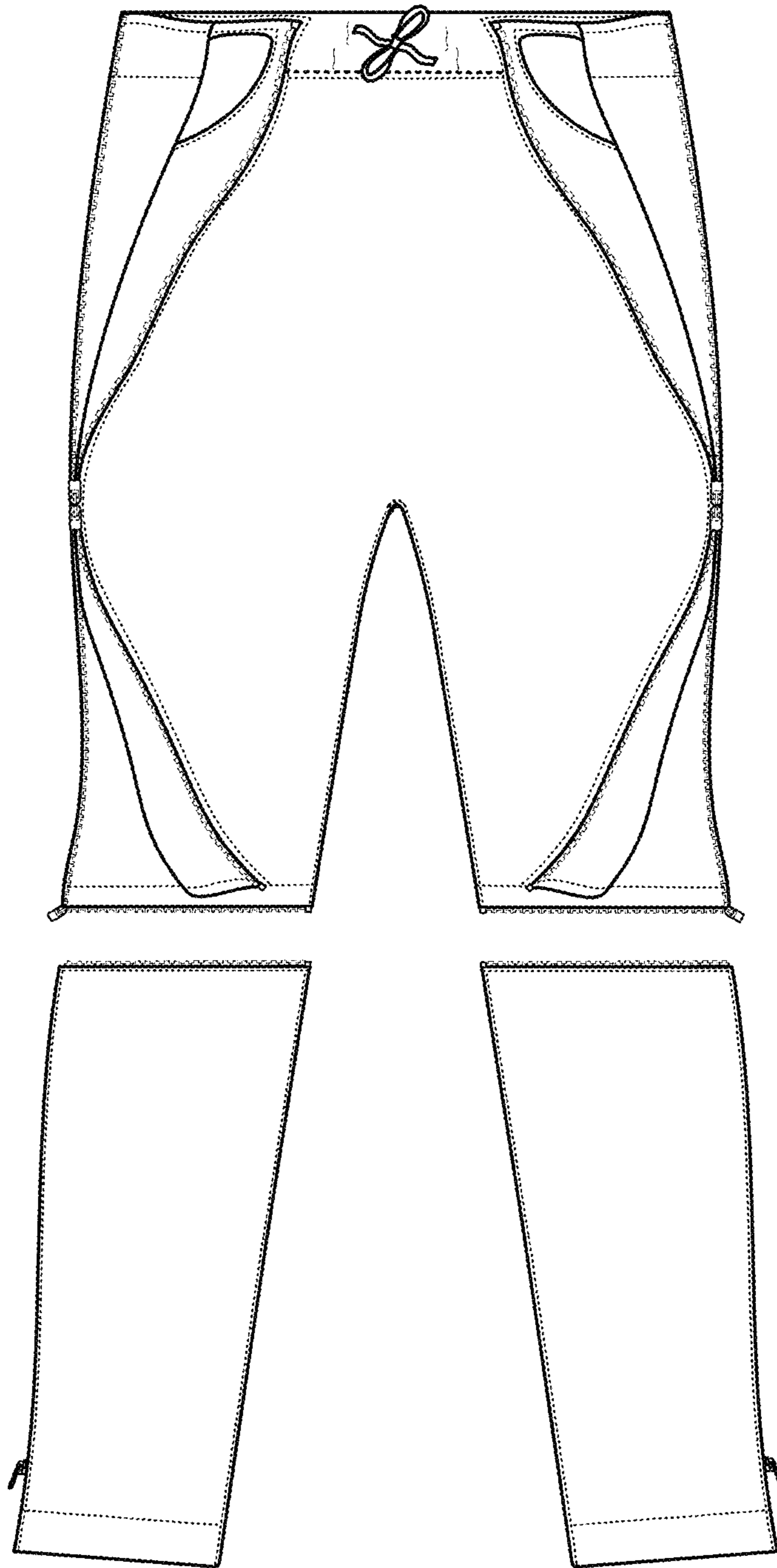

FIG. 12

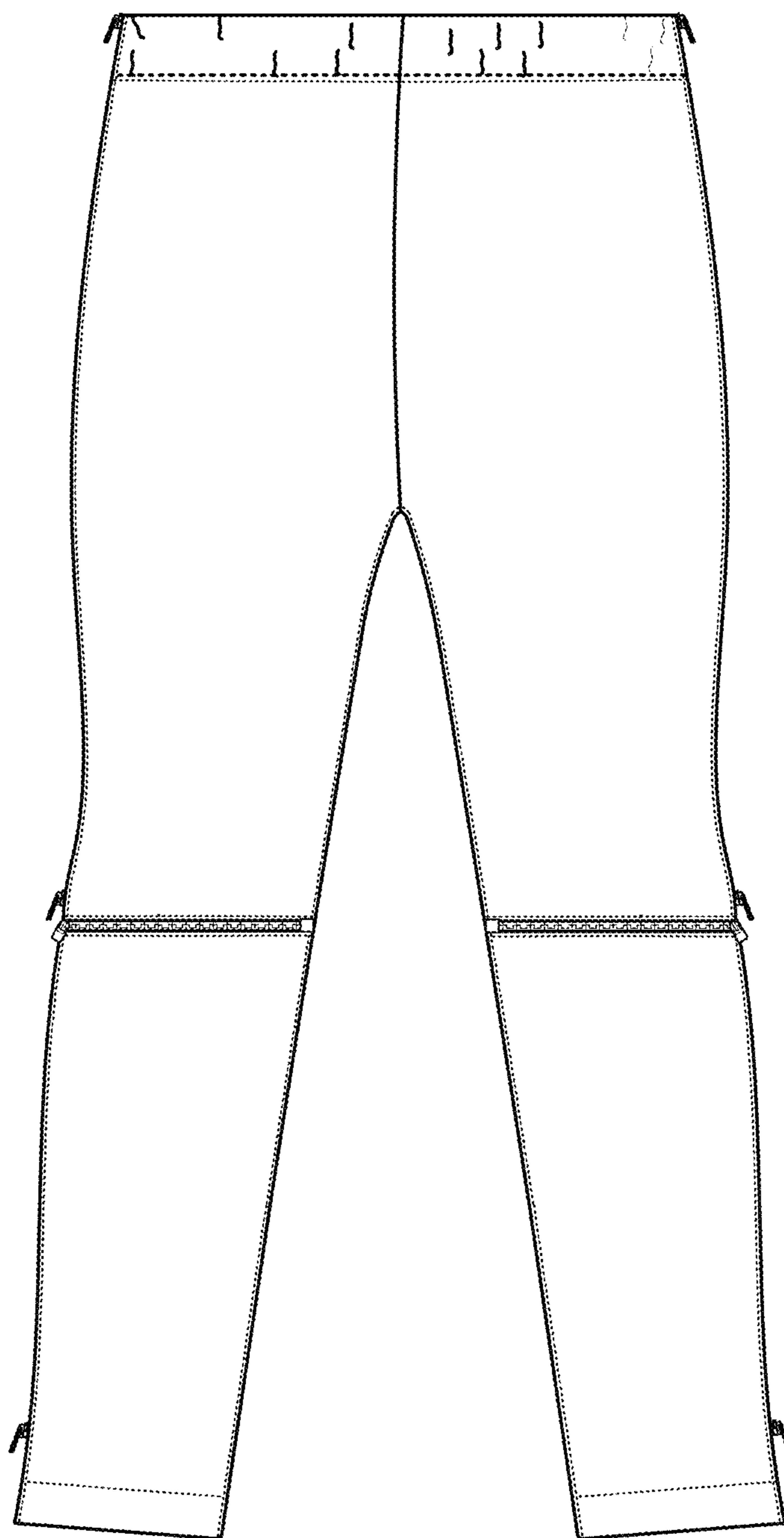

FIG. 13

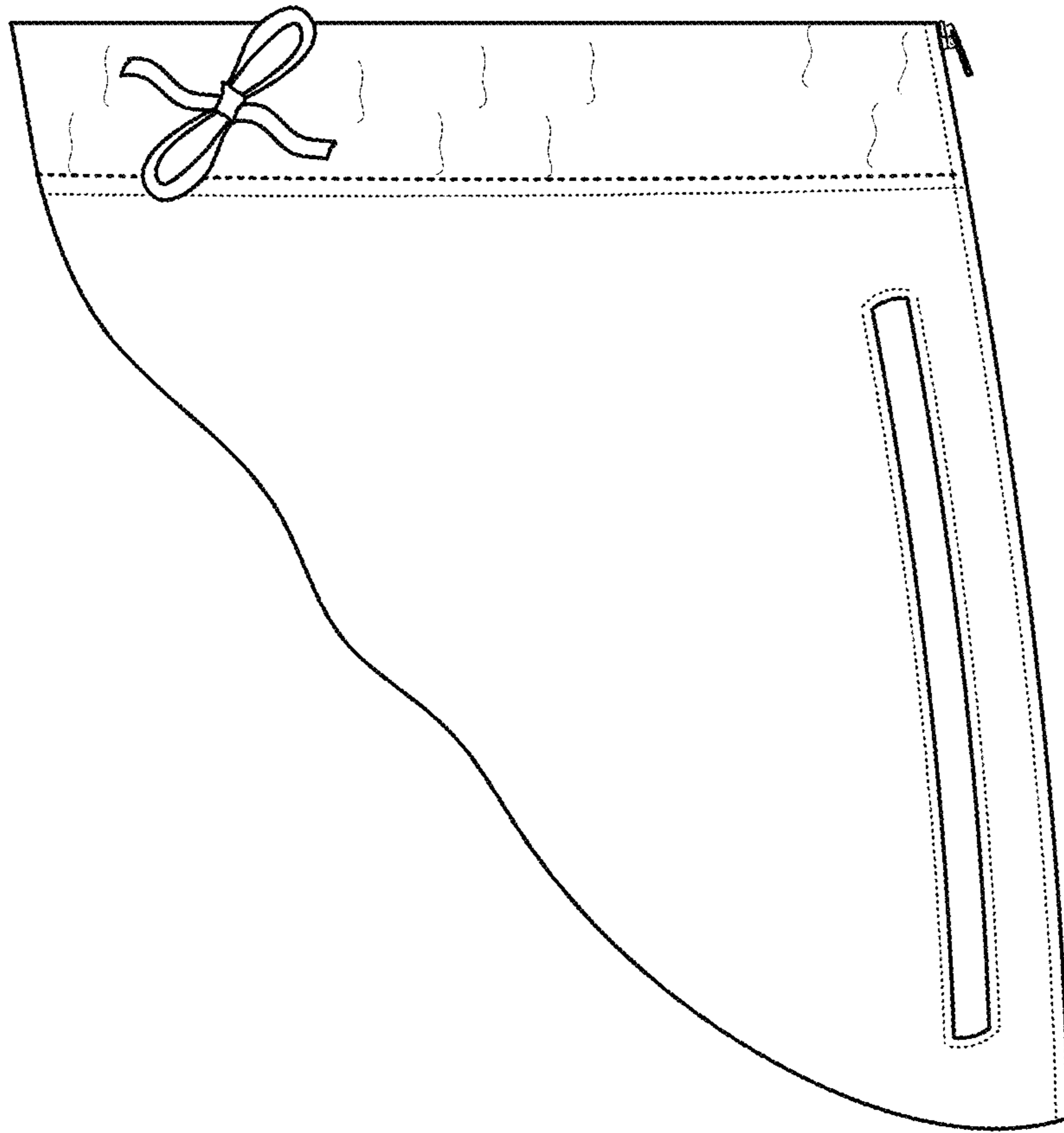

FIG. 14

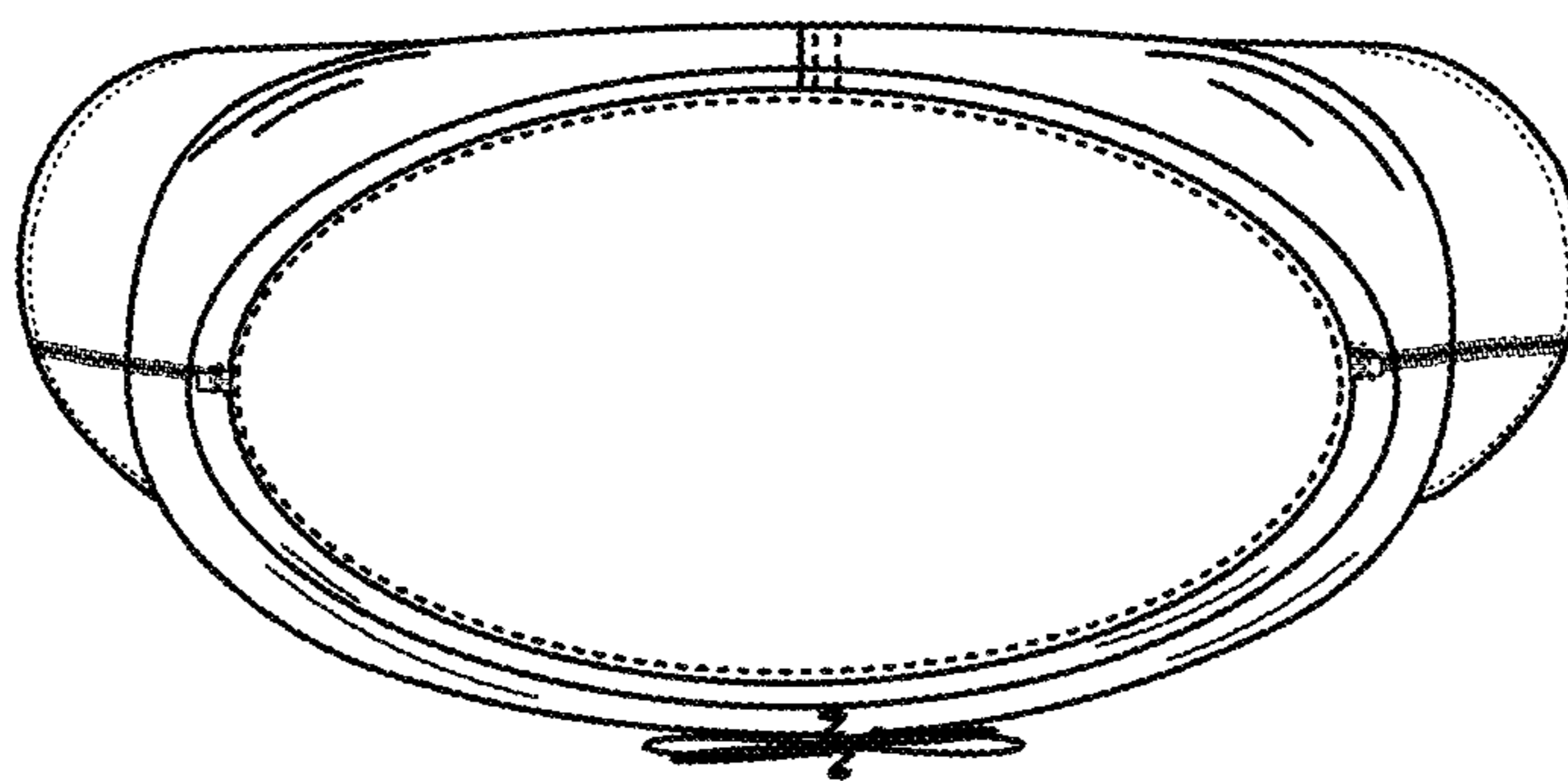

FIG. 15

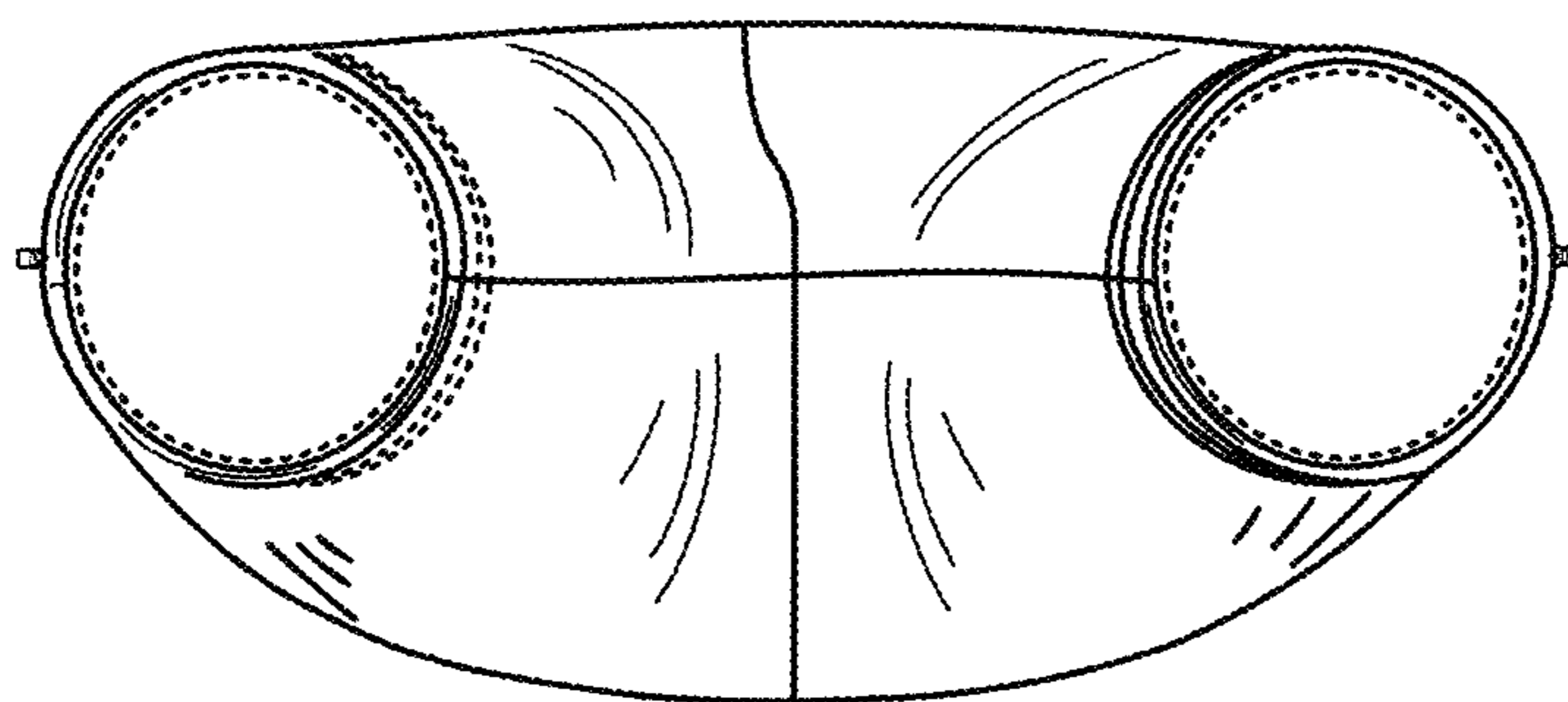

FIG. 16