



US00D834235S

(12) **United States Design Patent** (10) **Patent No.:** **US D834,235 S**
Gambrel et al. (45) **Date of Patent:** **** Nov. 20, 2018**

(54) **LIGHTING FIXTURE**

(71) Applicant: **The Urban Electric Company**, North Charleston, SC (US)

(72) Inventors: **Steven Gambrel**, New York, NY (US); **Michael Amato**, Johns Island, SC (US); **David Dawson**, Charleston, SC (US); **Jonathan Charpia**, Summerville, SC (US); **Christopher Roof**, Charleston, SC (US); **Joeangel Casanova**, North Charleston, SC (US); **Courteney Salsbury**, Mount Pleasant, SC (US); **Brianna Magagnoli**, Charleston, SC (US)

(73) Assignee: **The Urban Electric Company**, North Charleston, SC (US)

(**) Term: **15 Years**

(21) Appl. No.: **29/599,025**

(22) Filed: **Mar. 30, 2017**

(51) **LOC (11) Cl.** **26-05**

(52) **U.S. Cl.**
USPC **D26/89**

(58) **Field of Classification Search**
USPC D26/28, 35, 72, 74, 79-81, 83, 85, 86, D26/88, 89, 91, 118-122
CPC F21S 8/02; F21S 8/03; F21S 8/04; F21S 8/033; F21S 8/043; F21V 21/02
See application file for complete search history.

(56) **References Cited**

U.S. PATENT DOCUMENTS

D535,613 S *	1/2007	Varalo	D13/108
D558,382 S *	12/2007	Cesaro	D26/86
D633,645 S *	3/2011	Verelst	D26/89
D674,952 S *	1/2013	Crosby	D26/85

D679,036 S *	3/2013	Inoue	D26/24
D701,981 S *	4/2014	Gates	D26/24
D715,478 S *	10/2014	Blum	D26/85
D718,484 S *	11/2014	Eberle	D26/89
D730,570 S *	5/2015	Chen	D26/128
D751,236 S *	3/2016	Renshaw	D26/89
D824,078 S *	7/2018	Waldmann	D26/89
2011/0063829 A1 *	3/2011	Chen	E04B 9/006 362/231
2012/0020112 A1 *	1/2012	Fisher	A47B 13/12 362/608

OTHER PUBLICATIONS

Linden | SG-1602 (available online) Retrieved from the internet Sep. 18, 2018 from URL: <https://www.urbanelectricco.com/index.html>.*

(Continued)

Primary Examiner — Kevin K Rudzinski
Assistant Examiner — Richard Kearney
(74) *Attorney, Agent, or Firm* — Jeffrey T. Stover;
Haynsworth Sinkler Boyd, P.A.

(57) **CLAIM**

The ornamental design for a lighting fixture, as shown and described.

DESCRIPTION

FIG. 1 is a bottom plan view of a lighting fixture showing the new design;
FIG. 2 is a front elevational view thereof;
FIG. 3 is a back elevational view thereof.
FIG. 4 is a left side elevational view thereof;
FIG. 5 is a right side elevational view thereof; and,
FIG. 6 is a bottom perspective view thereof.
The broken lines shown on the drawings are understood to represent environmental structure that is not considered part of the claimed design.

1 Claim, 6 Drawing Sheets

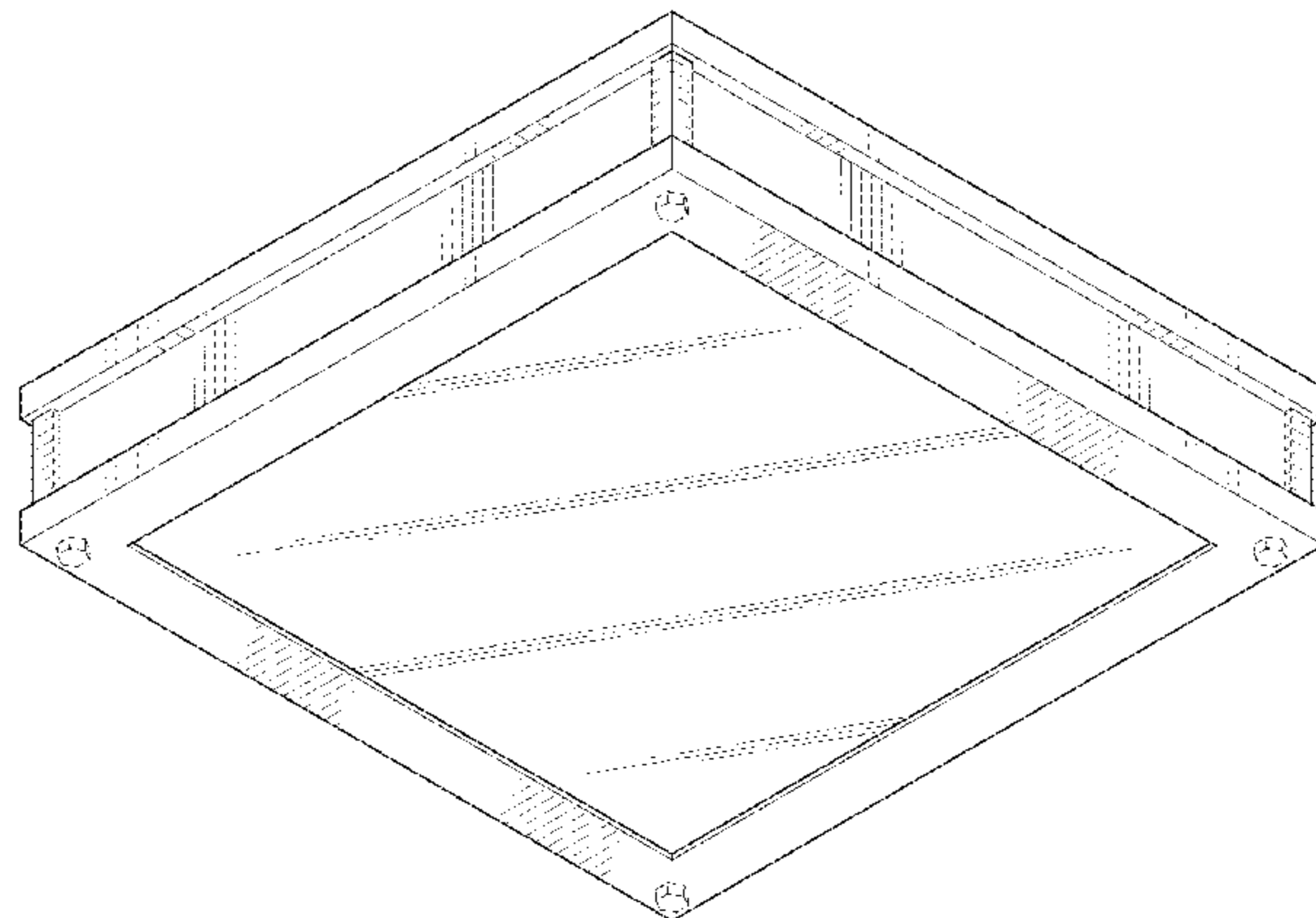

(56)

References Cited

OTHER PUBLICATIONS

Cermack ST. Flush Mount by Avenue Lighting (available online) Retrieved from the internet Sep. 20, 2018 from URL: <https://www.lumens.com/cermack-st.-flush-mount-by-avenue-lighting-AVLP212568.html#cgid=%0A%09%0A%09%0916%0A%09%0A&prefn1=Style&sz=96&start=105>.*

Led Ceiling Lights (available online) Retrieved from the internet Sep. 18, 2018 from URL: <http://www.terrassavermont.net/best-way-to-light-up-any-room-with-lowes-led-ceiling-lights/daylight-led-bulbs-lowes-led-ceiling-lights-8ft-led-light-fixture/>.*

Lithonia Lighting Square Saturn 13 in. Brushed Nickel LED Flushmount (available online) Retrieved from the internet Sep. 18, 2018 from URL: <https://www.homedepot.com/p/Lithonia-Lighting-Square-Saturn-13-in-Brushed-Nickel-LED-Flushmount-3000K-FMSSATL-13-14830-BN-M4/206514139>.*

QAZQA Modern Modern Square Share Outdoor Ceiling Lamp/ Ceiling Flush Light (available online) Retrieved from the internet Sep. 18, 2018 from URL: <https://www.amazon.co.uk/Modern-Square-Outdoor-Ceiling-Nickel/dp/B06VX9R5KY>.*

* cited by examiner

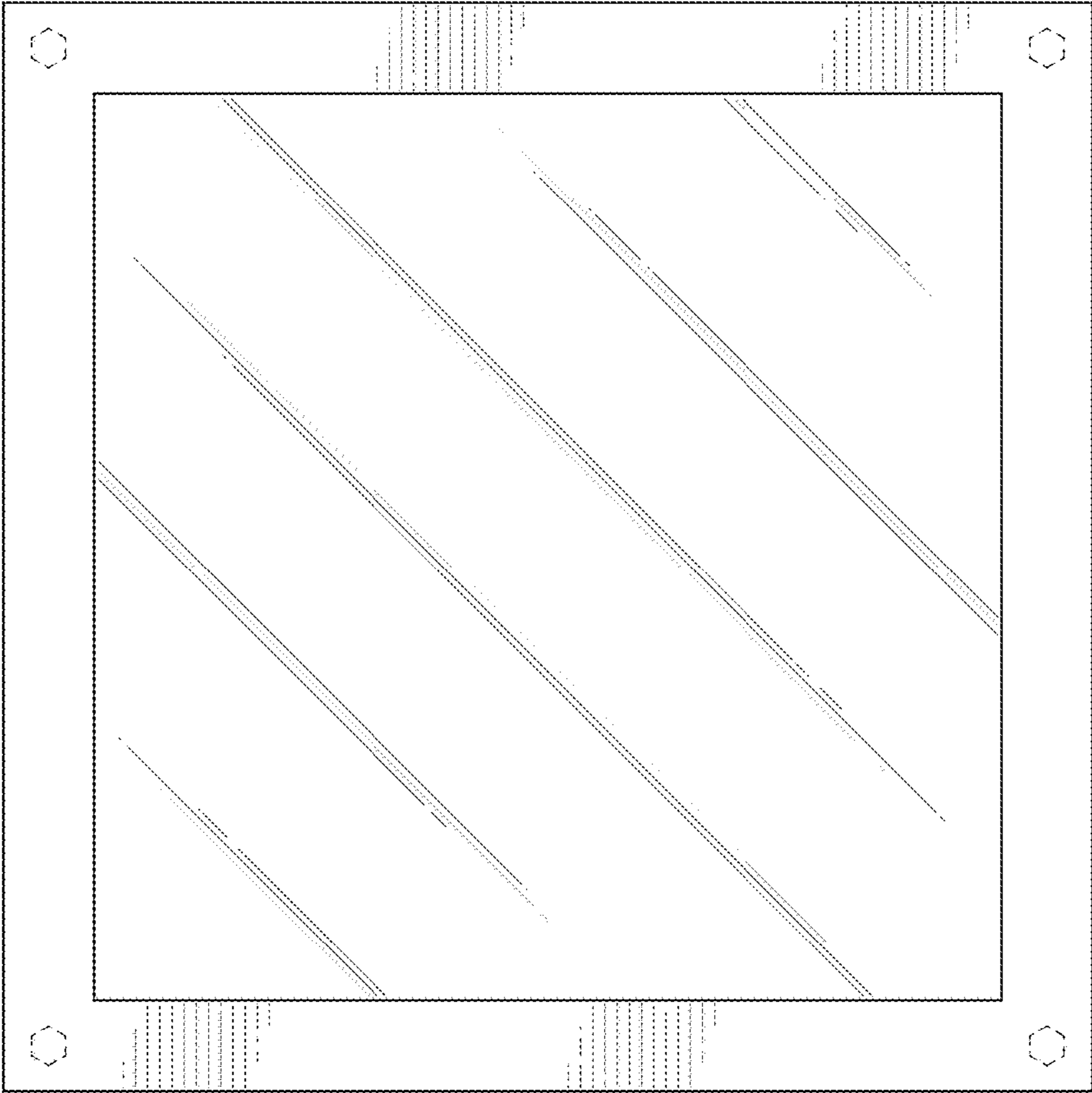

FIG. 1

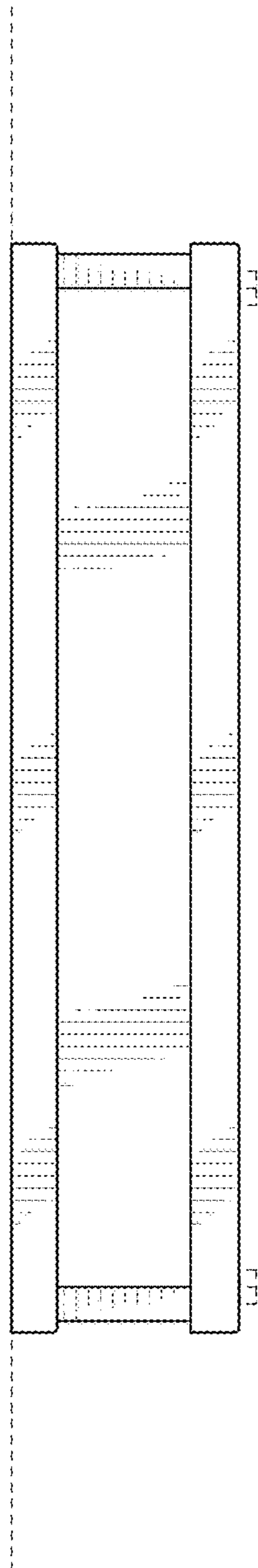

FIG. 2

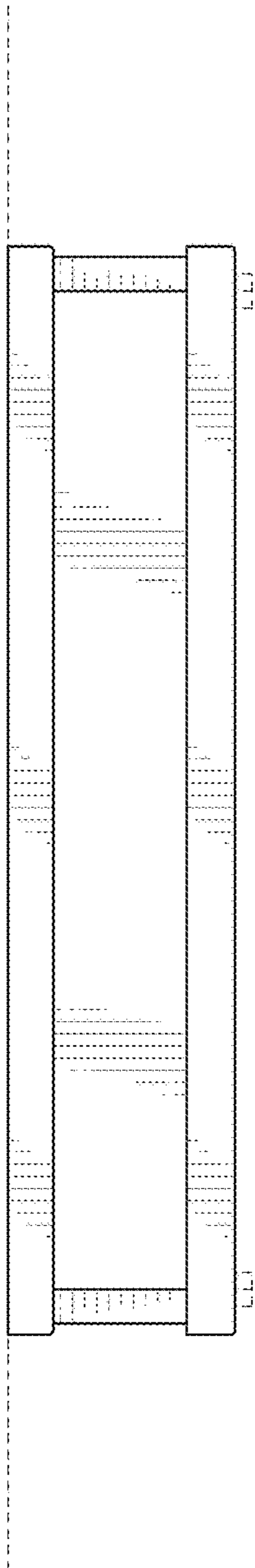

FIG. 3

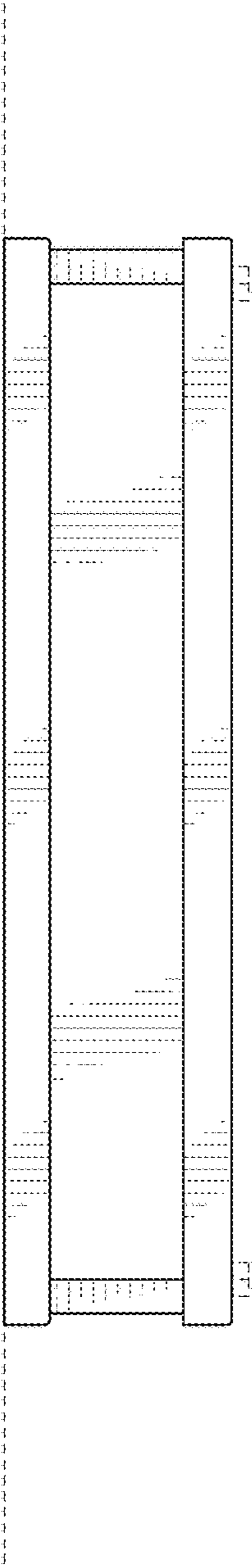

FIG. 4

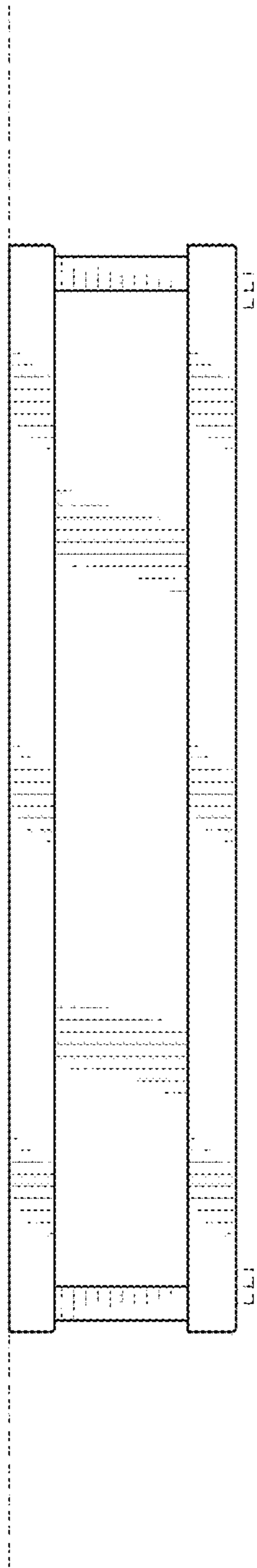

FIG. 5

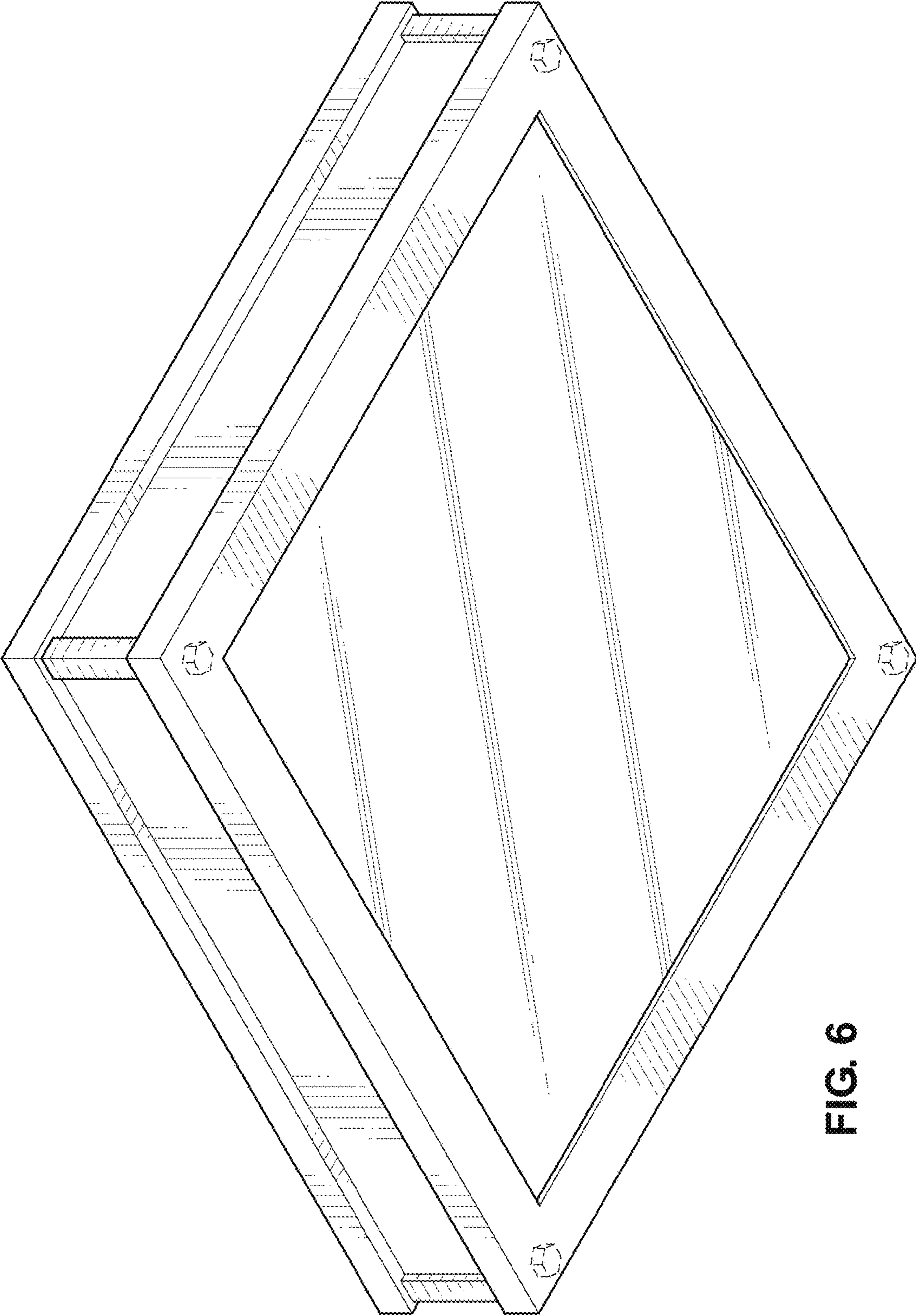

FIG. 6