



US00D834233S

(12) **United States Design Patent**
Mishan et al.

(10) **Patent No.:** **US D834,233 S**

(45) **Date of Patent:** **** Nov. 20, 2018**

(54) **ROCK DISK LIGHT**

(71) Applicant: **E. MISHAN & SONS, INC.**, New York, NY (US)

(72) Inventors: **Edward I Mishan**, New York, NY (US); **Fred Hollinger**, Monroe Township, NJ (US)

(73) Assignee: **E. Mishan & Sons, Inc.**, New York, NY (US)

(**) Term: **15 Years**

(21) Appl. No.: **29/643,988**

(22) Filed: **Apr. 13, 2018**

(51) **LOC (11) Cl.** **D26-05**

(52) **U.S. Cl.**
USPC **D26/67; D26/73**

(58) **Field of Classification Search**
USPC **D26/67, 68, 73, 125**
See application file for complete search history.

(56) **References Cited**

U.S. PATENT DOCUMENTS

D37,852 S *	2/1906	Fischer	D10/6
1,502,304 A *	7/1924	Gaines	F21V 21/10 362/414
4,835,644 A	5/1989	Wen		
5,055,984 A	10/1991	Hung		
D335,545 S *	5/1993	Metchear, III	D26/68
D338,736 S *	8/1993	Compton	D26/67
D343,021 S *	1/1994	Compton	D26/67
D379,669 S *	6/1997	Karanikas	D25/113
5,803,594 A *	9/1998	Fredrickson	F21S 8/032 362/351
6,013,985 A	1/2000	Green		
6,073,411 A *	6/2000	Ciccarello	E01C 5/06 404/41
6,131,321 A	10/2000	Daigle, Jr.		

(Continued)

FOREIGN PATENT DOCUMENTS

CN 200830247356.0 11/2009
CN 201430557956.7 6/2016

(Continued)

OTHER PUBLICATIONS

LampLust Solar Brick LED Landscape Light, at amazon.com as early as Oct. 28, 2015. (Year: 2015).*

(Continued)

Primary Examiner — Clare E Heflin

(74) *Attorney, Agent, or Firm* — Notaro, Michalos & Zaccaria P.C.

(57) **CLAIM**

The ornamental design for a rock disk light, as shown and described.

DESCRIPTION

FIG. 1 is a top, left perspective view of a rock disk light showing our design therefor;
 FIG. 2 is a left side elevational view thereof;
 FIG. 3 is a right side elevational view thereof;
 FIG. 4 is a front elevational view thereof;
 FIG. 5 is a rear elevational view thereof;
 FIG. 6 is a top plan view thereof;
 FIG. 7 is a bottom plan view thereof;
 FIG. 8 is top left perspective view of a second embodiment of our design;
 FIG. 9 is a left side elevational view thereof;
 FIG. 10 is a right side elevational view thereof;
 FIG. 11 is a front elevational view thereof;
 FIG. 12 is a rear elevational view thereof;
 FIG. 13 is a top plan view thereof; and,
 FIG. 14 is a bottom plan view thereof.

1 Claim, 10 Drawing Sheets

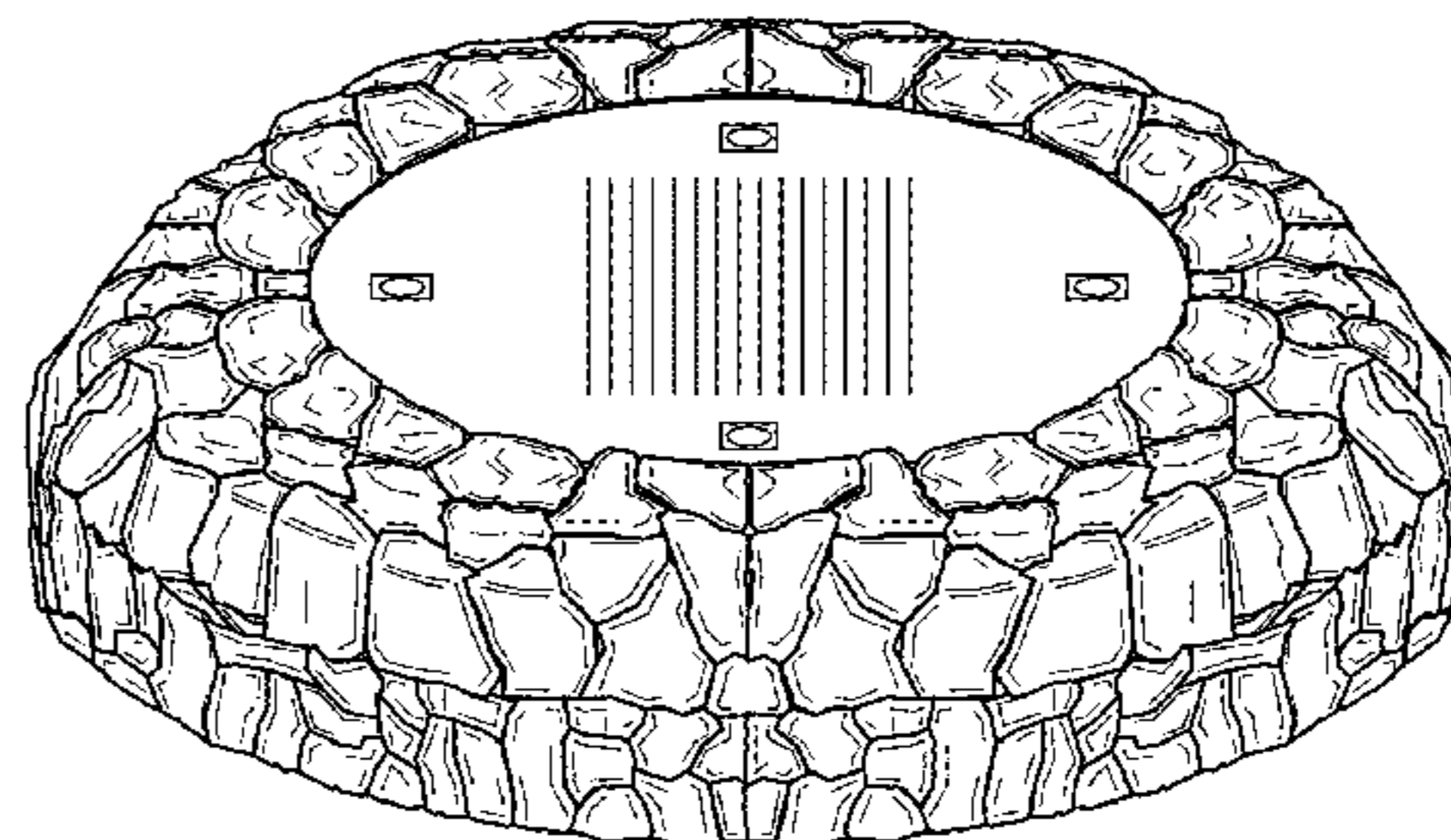
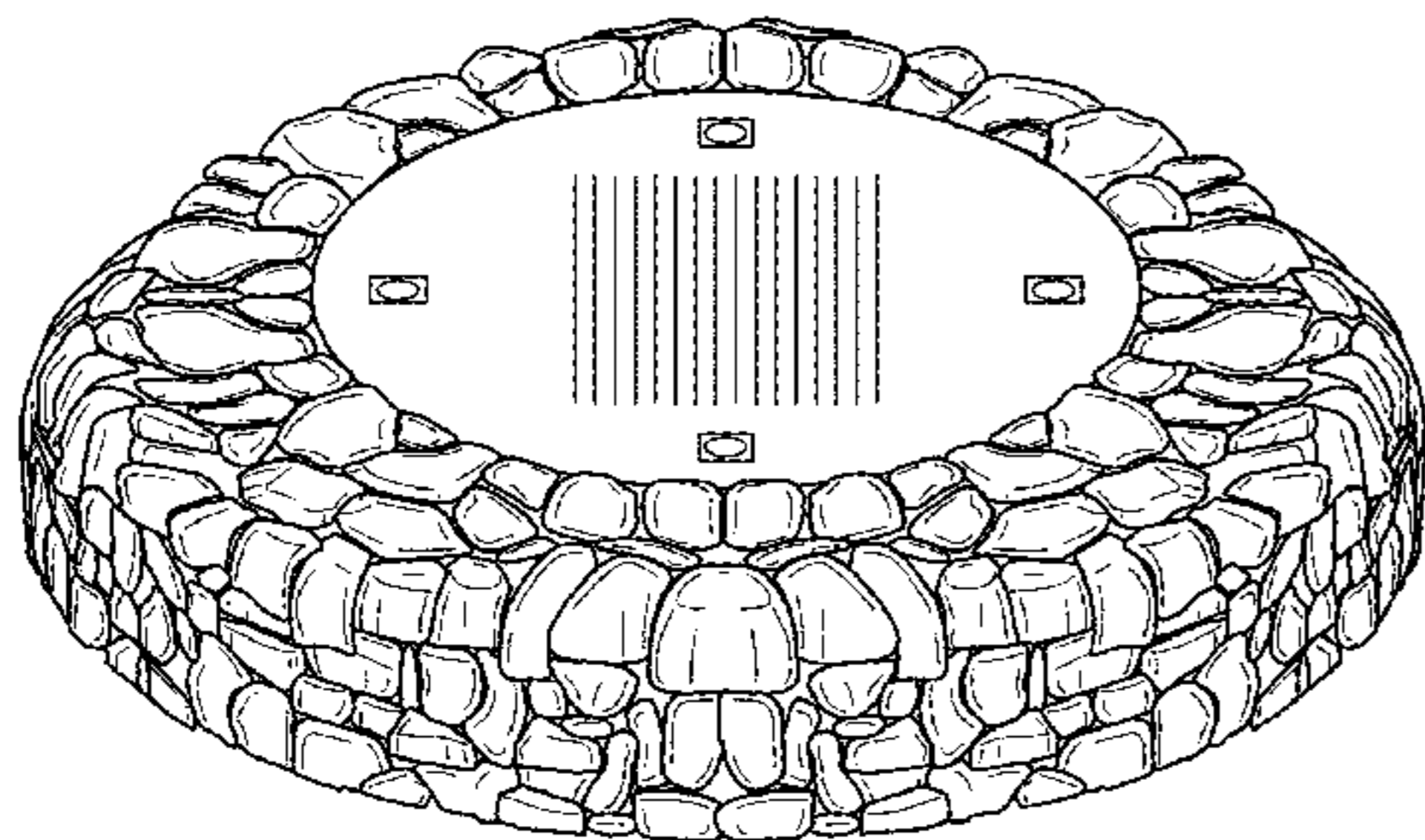

(56)

References Cited

U.S. PATENT DOCUMENTS

D438,322 S 2/2001 Skradski
 D445,523 S 7/2001 Skradski
 D450,150 S 11/2001 Skradski
 D451,618 S 12/2001 Skradski
 D451,619 S 12/2001 Skradski
 6,339,188 B1 1/2002 Voelkner
 6,406,163 B1 6/2002 Yang
 6,455,113 B1* 9/2002 Bilodeau B44C 3/123
 362/147
 D483,903 S 12/2003 Skradski
 D483,904 S 12/2003 Skradski
 6,729,742 B2 5/2004 Inismeth
 D494,536 S 8/2004 Pu
 D504,741 S* 5/2005 Ferrari D26/73
 6,932,489 B2* 8/2005 Sooferian E01C 17/00
 362/145
 D517,717 S 3/2006 Sanoner
 D517,719 S 3/2006 Sanoner
 7,029,144 B2 4/2006 Fu
 7,172,307 B2 2/2007 Izardel
 7,196,477 B2 3/2007 Richmond
 D551,791 S 9/2007 Sanoner
 D555,278 S 11/2007 Sanoner
 D556,933 S 12/2007 Sanoner
 D574,104 S 7/2008 Sanoner
 D574,538 S* 8/2008 Sanoner D26/67
 7,429,827 B2 9/2008 Richmond
 7,503,669 B2 3/2009 Rizkin
 7,588,349 B2 9/2009 Yen
 D605,326 S 12/2009 Sanoner
 D616,129 S* 5/2010 Sanoner D26/67
 7,887,214 B2 2/2011 Chang
 D642,722 S 8/2011 Oberpriller
 8,186,857 B2 5/2012 Porter
 8,203,285 B2 6/2012 Chen
 8,220,959 B2 7/2012 Rizkin
 8,222,823 B2 7/2012 Hsu
 8,292,452 B2 10/2012 Ko
 8,348,452 B2 1/2013 Zheng
 8,362,700 B2 1/2013 Richmond
 8,454,208 B2 6/2013 Porter
 D690,459 S* 9/2013 Asquith D26/125
 8,602,585 B1 12/2013 Lowe
 D698,061 S* 1/2014 Burke D26/67
 8,632,234 B1 1/2014 Lowe
 8,664,866 B2 3/2014 Kay
 8,845,126 B1 9/2014 Martzall
 D743,079 S 11/2015 Adair
 9,175,821 B2 11/2015 Adair
 9,200,810 B2* 12/2015 Fulkerson F24C 7/004
 9,222,634 B2 12/2015 Zhu
 9,273,841 B2* 3/2016 Philhower F21S 8/022
 9,335,013 B2 5/2016 Martzall
 D770,076 S 10/2016 Li
 9,572,304 B2 2/2017 Harari
 9,657,909 B2 5/2017 Cohen
 D800,940 S 10/2017 Guzzini

D822,253 S* 7/2018 Wu D26/68
 2003/0137831 A1 7/2003 Lin
 2006/0012996 A1 1/2006 Tseng
 2006/0187656 A1 8/2006 Kuelbs
 2007/0002561 A1 1/2007 Tesmer
 2007/0121317 A1 5/2007 Huang
 2007/0263381 A1 11/2007 Goldman
 2009/0027900 A1 1/2009 Janos
 2009/0059572 A1 3/2009 Wang
 2011/0013384 A1 1/2011 Lu
 2011/0310597 A1 12/2011 Lu
 2016/0230972 A1 8/2016 Choi
 2017/0135226 A1 5/2017 Chen
 2017/0184260 A1 6/2017 Munoz Abogabir

FOREIGN PATENT DOCUMENTS

EM 000380670-0001 8/2005
 EM 002733949-0041 7/2015
 EM 004129617-0001 8/2017
 EM 004362432-0002 9/2017
 EM 004426237-0004 10/2017

OTHER PUBLICATIONS

Tutu Tech Direct Faux-Rock Outdoor Disk Light. Available at amazon.com as early as Jul. 4, 2018. (Year: 2018).*
 Dec. 5, 2017 “Wenjuan 8 LED Solar Power Buried Light Ground Lamp Outdoor Path Way Garden Decking” [https://www.amazon.com/Wenjuan-Buried-Ground-Outdoor-Decking/dp/B077Z4Q-T5L/].
 Dec. 16, 2017 “Solar Underground Light,Rambling 8LED Power Buried Light Under Ground Lamp Waterproof Outdoor Path Way Garden Decking Auto On Off Switch Cool White” [https://www.amazon.com/Underground-Rambling-Waterproof-Outdoor-Decking/dp/B078G56VLP/].
 Dec. 24, 2017 “8-LEDs Solar Power Ground Light, ONEVER Spike Lighting Built-in Light Sensor IPX4 Waterproof for Path Floor Yard Driveway Lawn Pathway (Pack of 4X)” [https://www.amazon.com/ONEVER-Lighting-Waterproof-Driveway-Pathway/dp/B078LW7-ZLT/].
 May 26, 2017 “NUMARDA 4Pcs 4 LED Solar Powered Ground Lights Outdoor lamp Waterproof LED Solar Path Lights Garden Landscape Spike Lighting for Yard Driveway Lawn Pathway—White” [https://www.amazon.com/Powered-Waterproof-Landscape-Lighting-Driveway/dp/B07125KXLW/].
 Jun. 8, 2017 “Hometom Solar Powered Ground Light Outdoor Lights Waterproof LED Solar Path Lights Garden Landscape Lighting—4 Pack” [https://www.amazon.com/Powered-Outdoor-Waterproof-Landscape-Lighting/dp/B07BQY5M5H/].
 Jun. 24, 2017 “Solar Powered Ground Light, Alvivi Outdoor Waterproof Garden Pathway Lights with 4 LEDs, Walkway Lights for Home, Yard, Driveway, Lawn, 4 Pack (White)” [https://www.amazon.com/Powered-Alvivi-Outdoor-Waterproof-Driveway/dp/B073XLD3KN/].
 Aug. 24, 2016 “CST Lighting Solar Ground Light 4-Pack, for Garden Landscape Lighting, Pathway, Stairway” [https://www.amazon.com/dp/B01KY7808S].

* cited by examiner

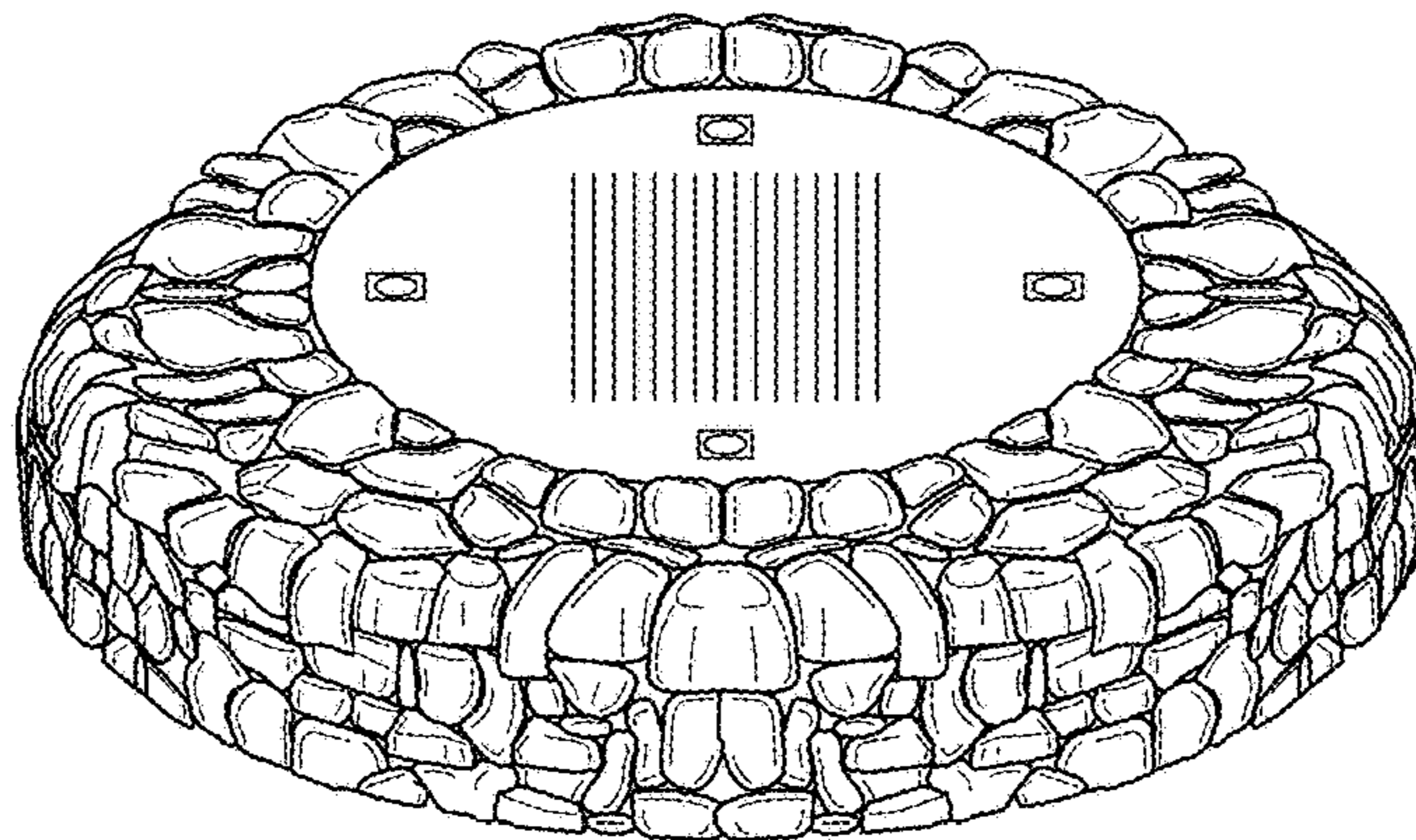

FIG. 1

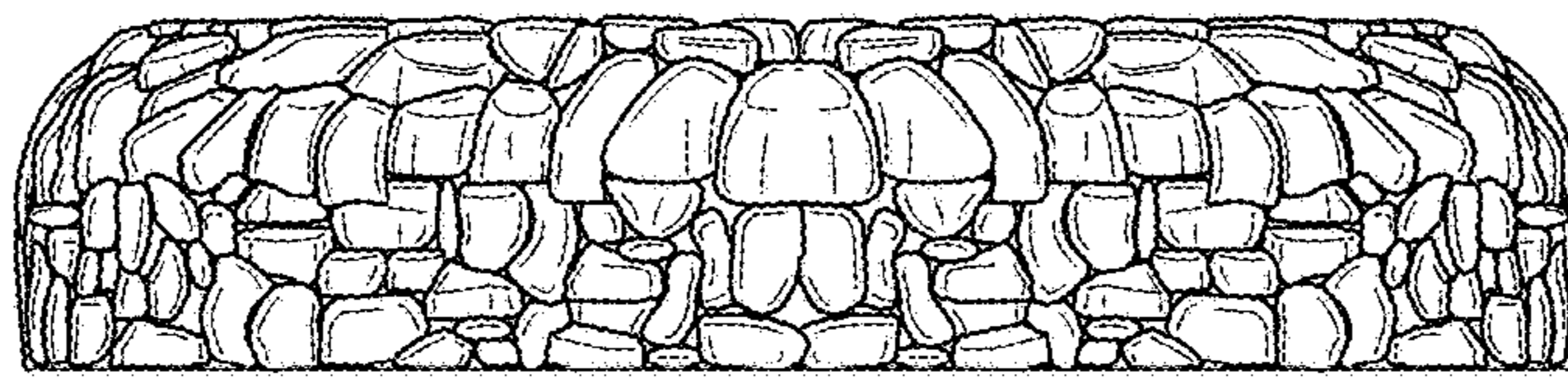

FIG. 2

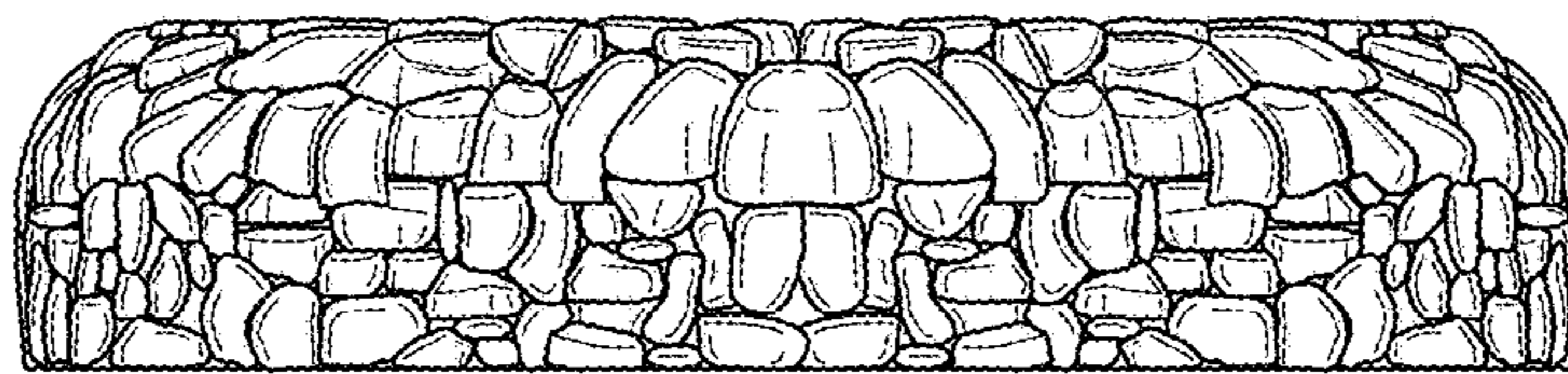

FIG. 3

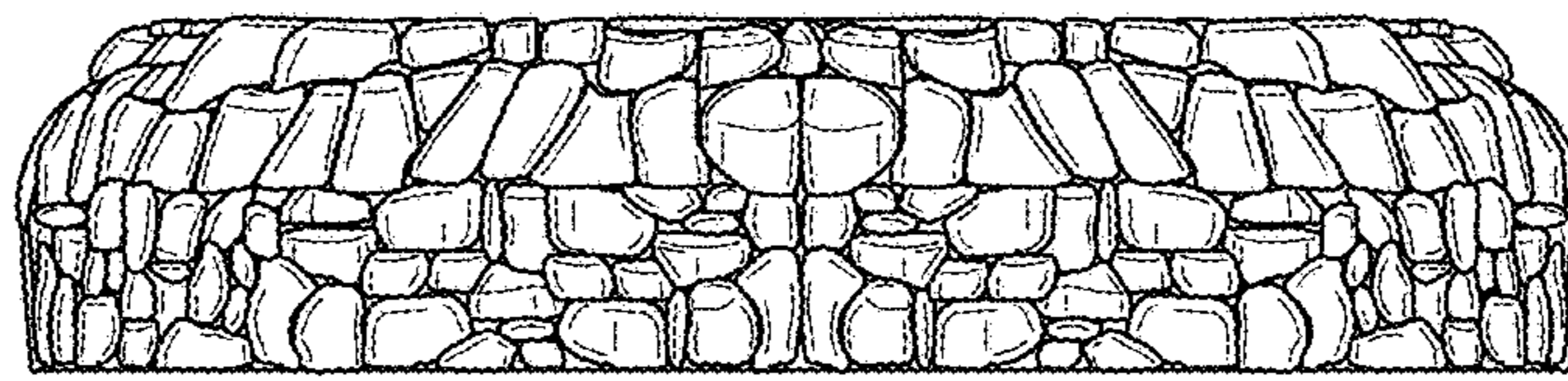

FIG. 4

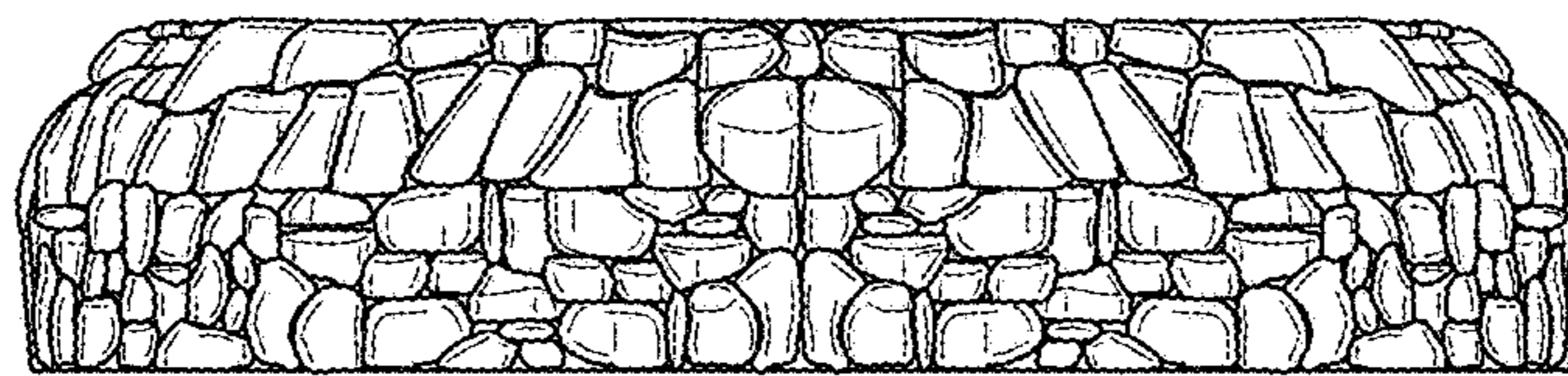

FIG. 5

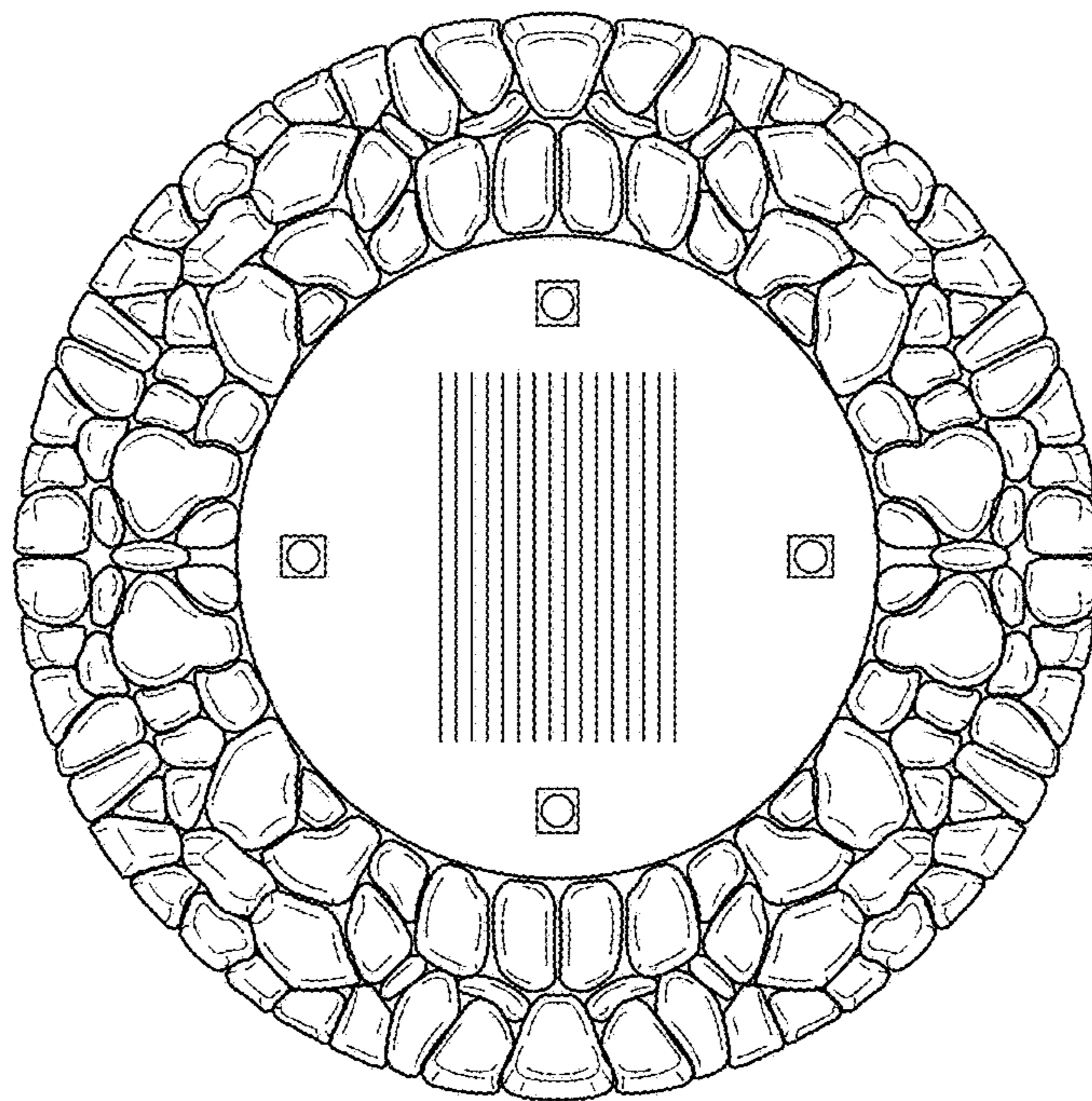

FIG. 6

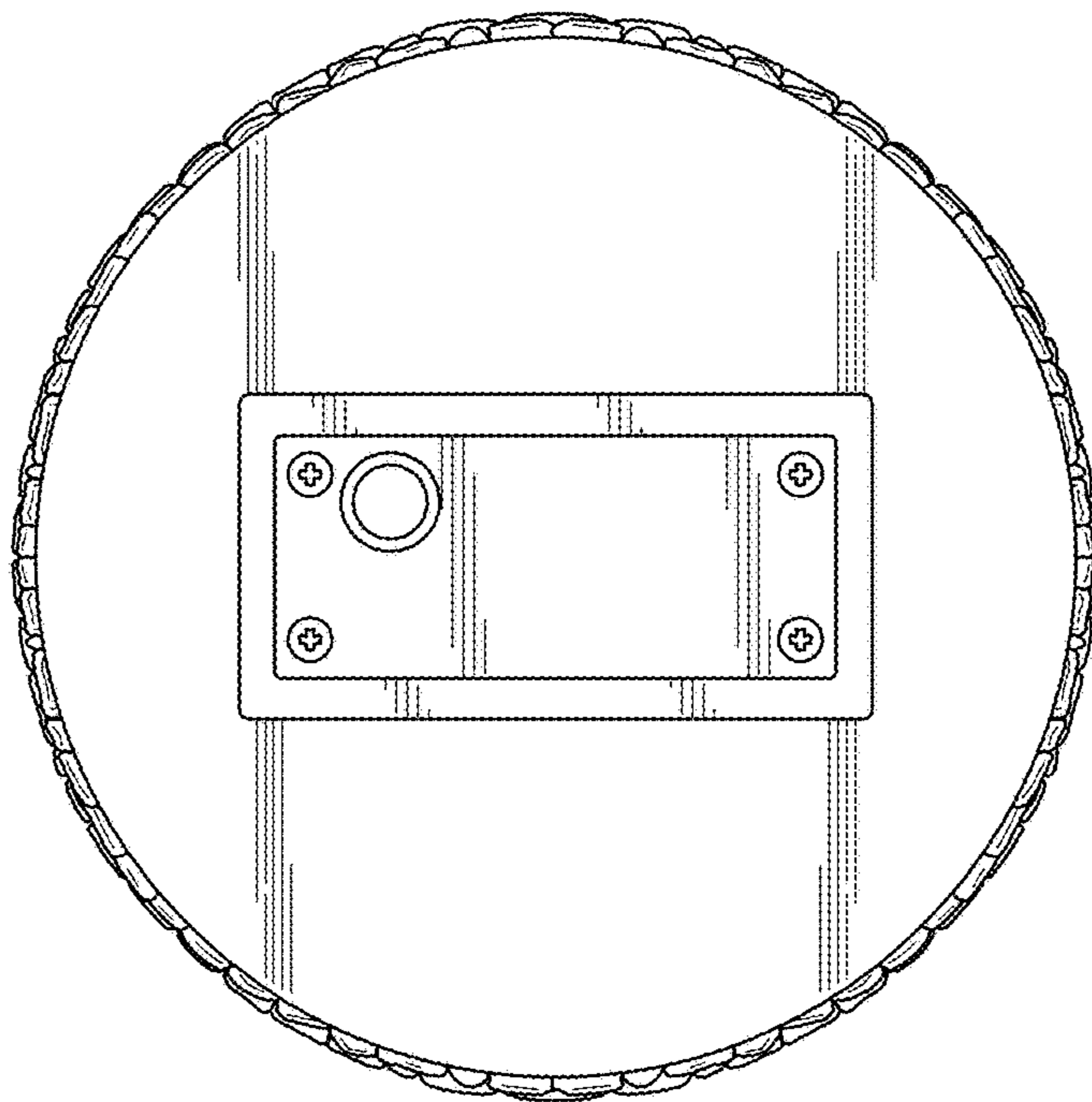

FIG. 7

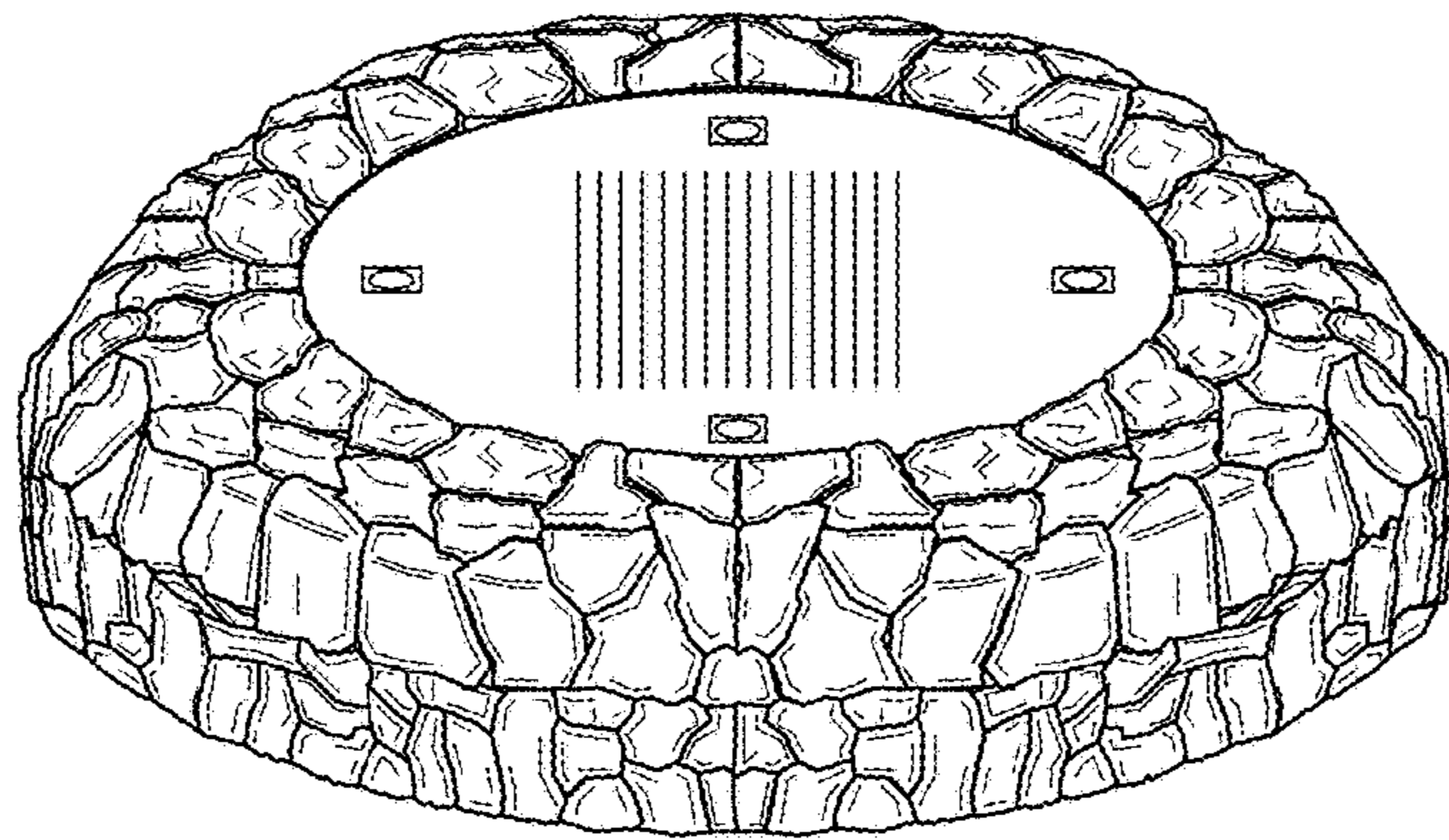

FIG. 8

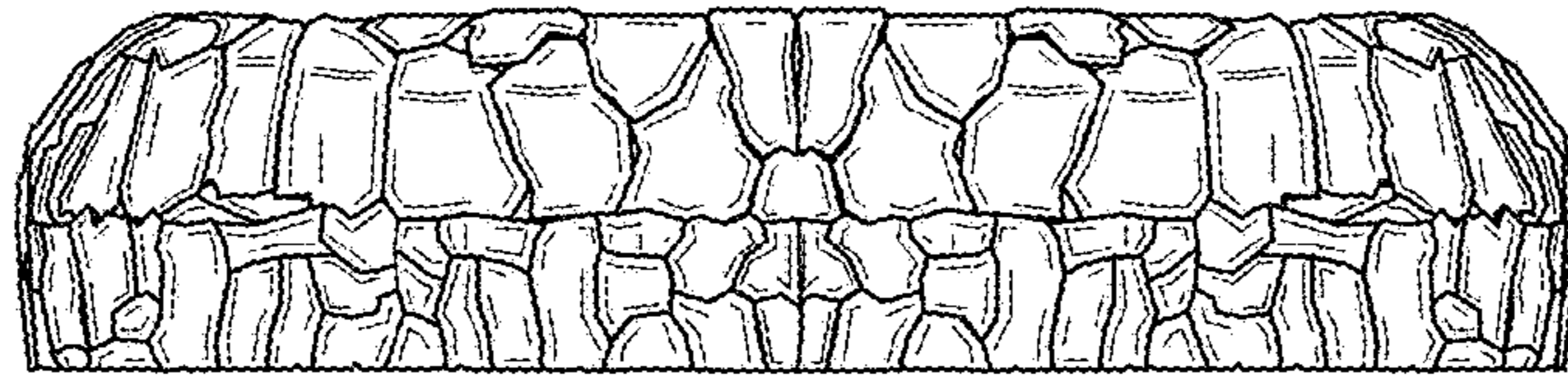

FIG. 9

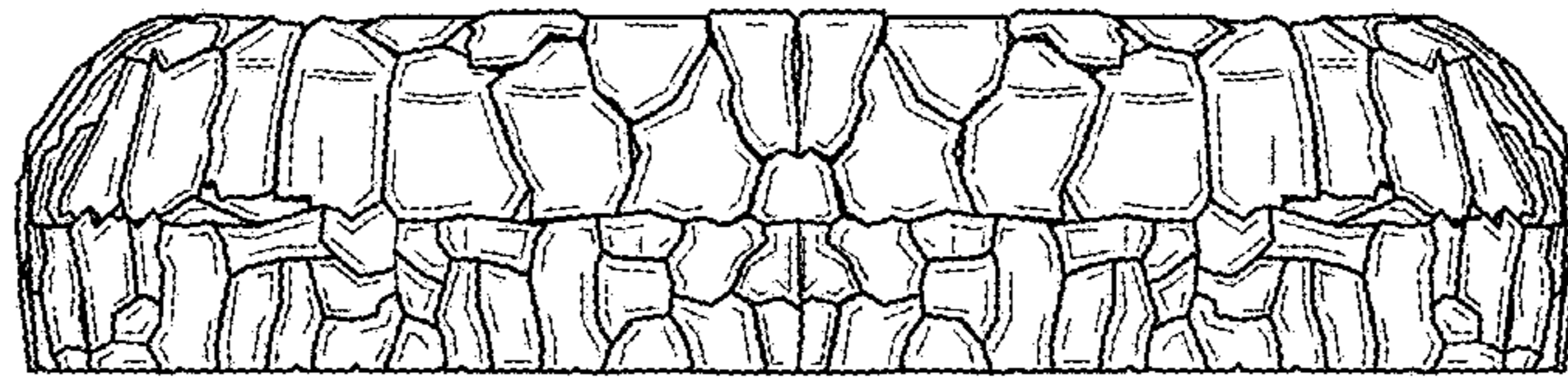

FIG. 10

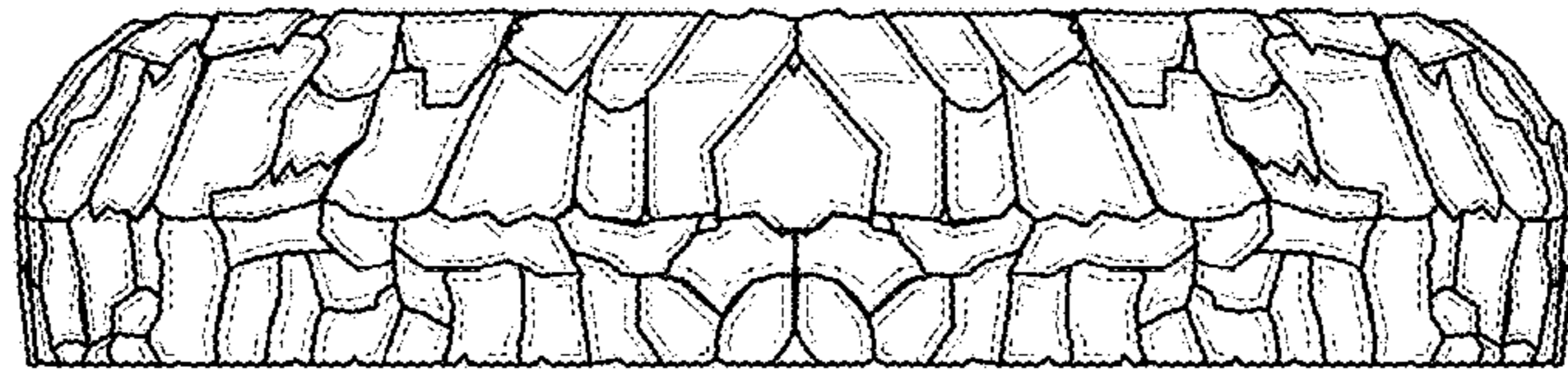

FIG. 11

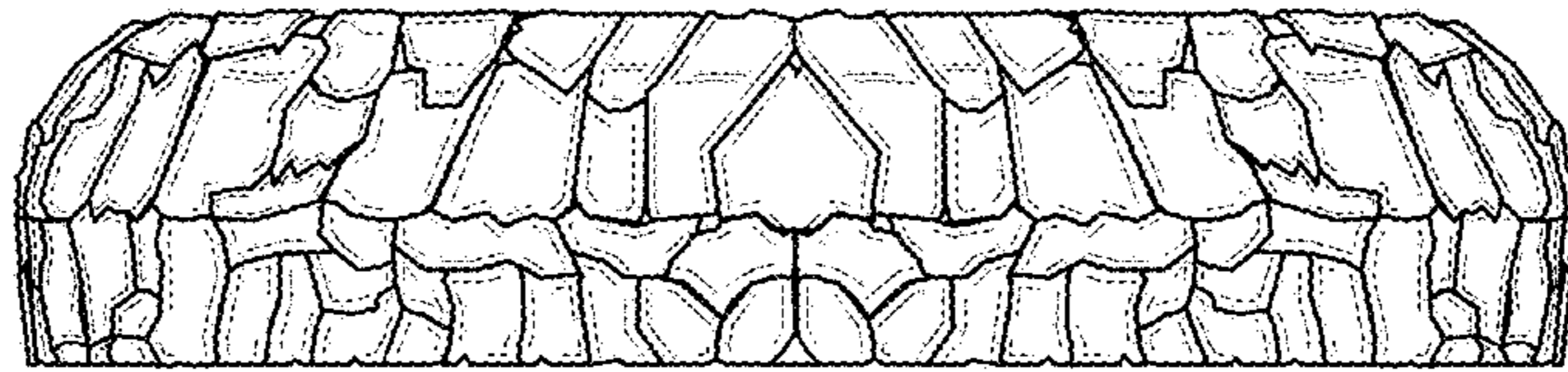

FIG. 12

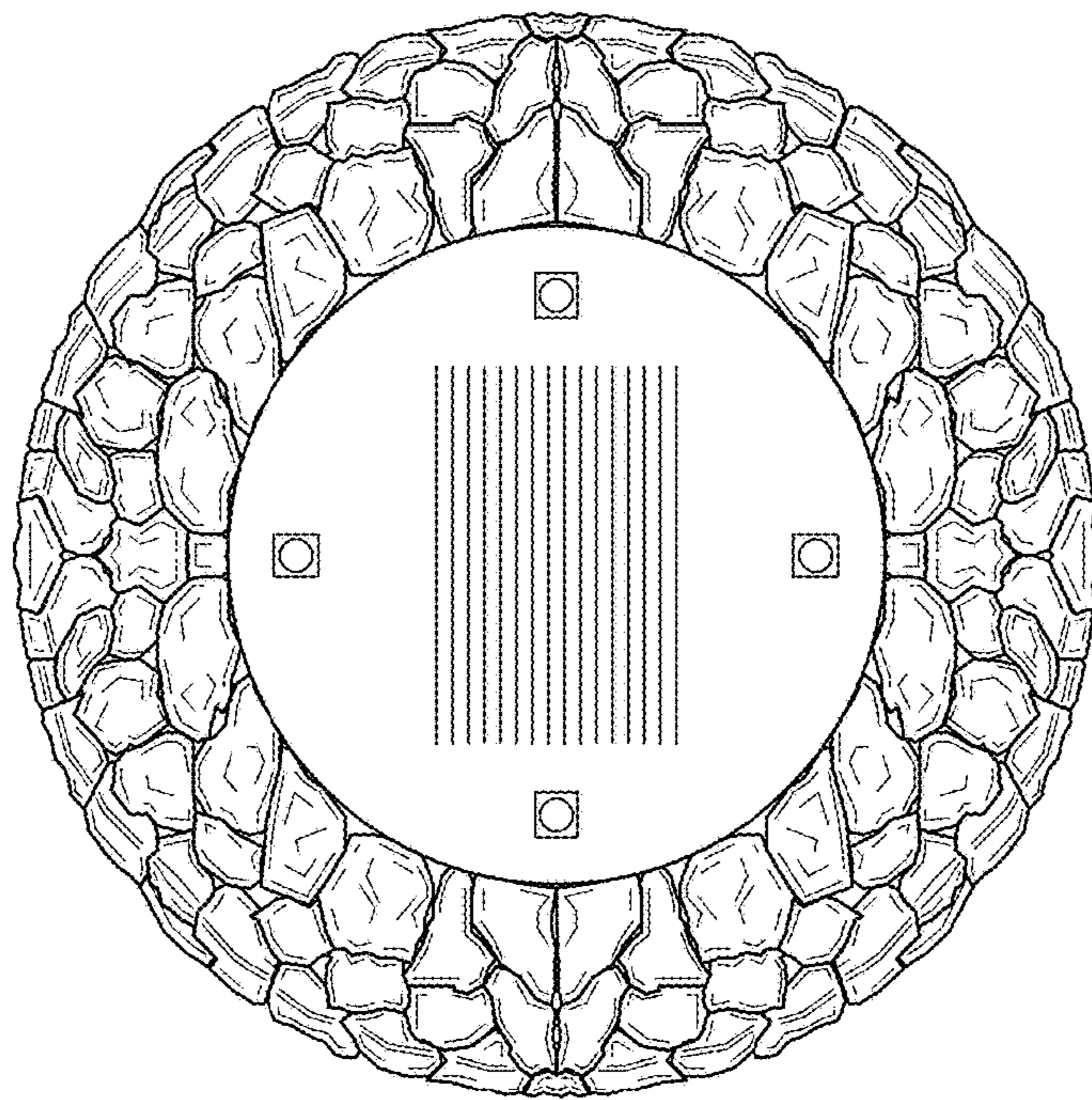

FIG. 13

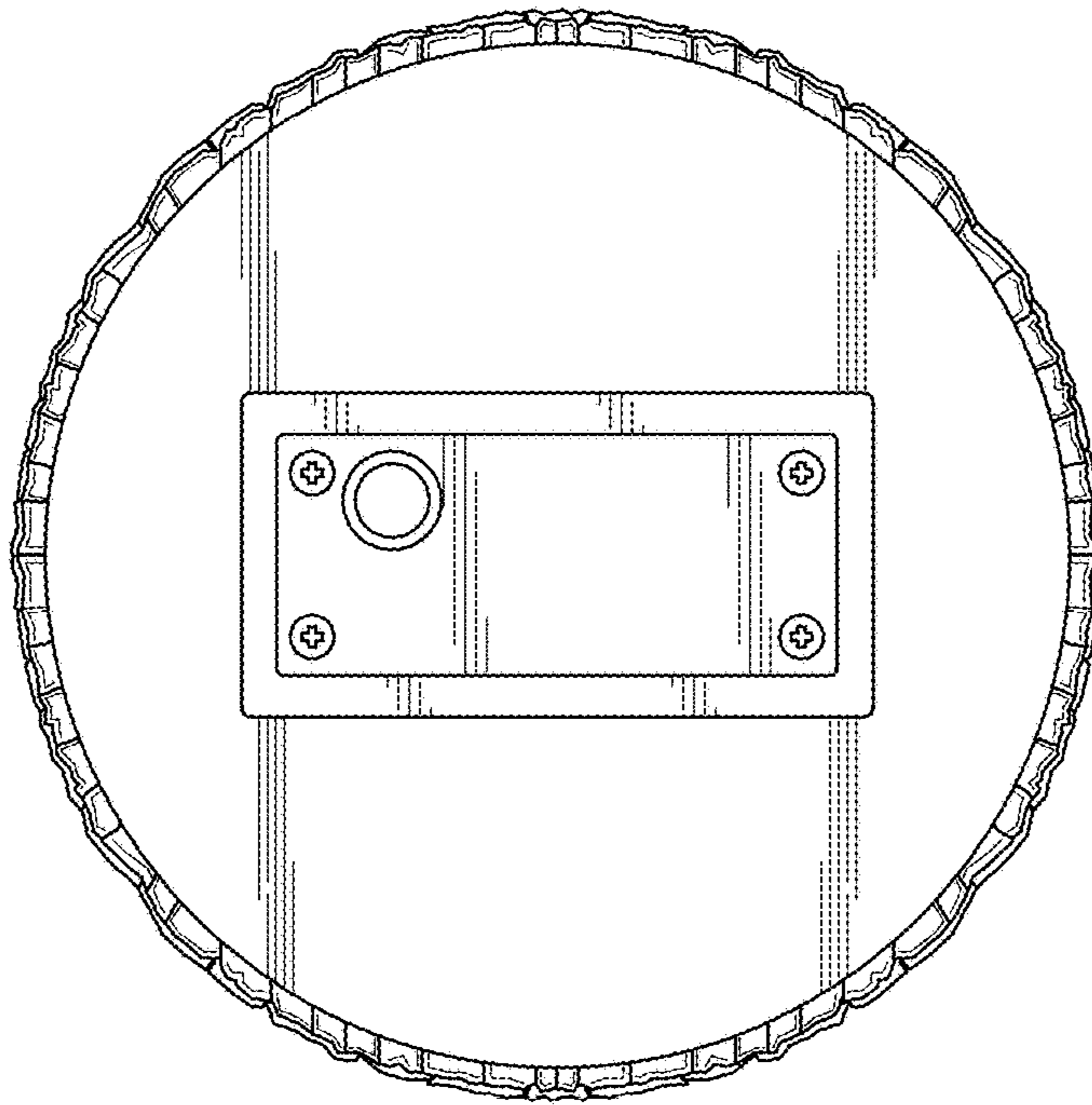

FIG. 14