



US00D834195S

(12) **United States Design Patent**  
**Chamberlain et al.**

(10) **Patent No.:** **US D834,195 S**

(45) **Date of Patent:** **\*\* Nov. 20, 2018**

(54) **ULTRASOUND DEVICE**

(71) Applicant: **FUJIFILM SonoSite, Inc.**, Bothell,  
WA (US)

(72) Inventors: **Craig Chamberlain**, Seattle, WA (US);  
**Evan McCormack**, Kemore, WA (US);  
**Josh Hansen**, Everett, WA (US)

(73) Assignee: **FUJIFILM SonoSite, Inc.**, Bothell,  
WA (US)

(\*\*) Term: **15 Years**

(21) Appl. No.: **29/578,630**

(22) Filed: **Sep. 22, 2016**

**Related U.S. Application Data**

(63) Continuation of application No. 29/525,653, filed on  
Apr. 30, 2015, now Pat. No. Des. 767,764.

(51) **LOC (11) Cl.** ..... **24-01**

(52) **U.S. Cl.**  
USPC ..... **D24/158; D24/186**

(58) **Field of Classification Search**  
USPC ..... D24/158-161, 185, 186, 107; D14/341  
CPC .... A61B 8/13; A61B 8/44; A61B 8/42; A61B  
8/46; A61B 8/54  
See application file for complete search history.

(56) **References Cited**

**U.S. PATENT DOCUMENTS**

D461,895 S \* 8/2002 Barnes ..... D24/158  
D469,539 S \* 1/2003 Felix ..... D24/187

D549,830 S \* 8/2007 Behar ..... D24/186  
D558,351 S 12/2007 Diener et al.  
D562,456 S 2/2008 Scruggs et al.  
D590,509 S \* 4/2009 Costa ..... D24/186  
D593,551 S 6/2009 Ferrari et al.  
D606,659 S \* 12/2009 Kiani ..... D24/186  
D621,515 S 8/2010 Chua et al.  
D629,113 S 12/2010 Wodecki et al.  
D650,484 S 12/2011 Shinohara et al.  
D723,173 S 2/2015 Kim et al.  
D725,784 S 3/2015 Xia et al.  
D767,764 S 9/2016 Chamberlain et al.

\* cited by examiner

*Primary Examiner* — Anhdao Doan

(74) *Attorney, Agent, or Firm* — Perkins Coie LLP

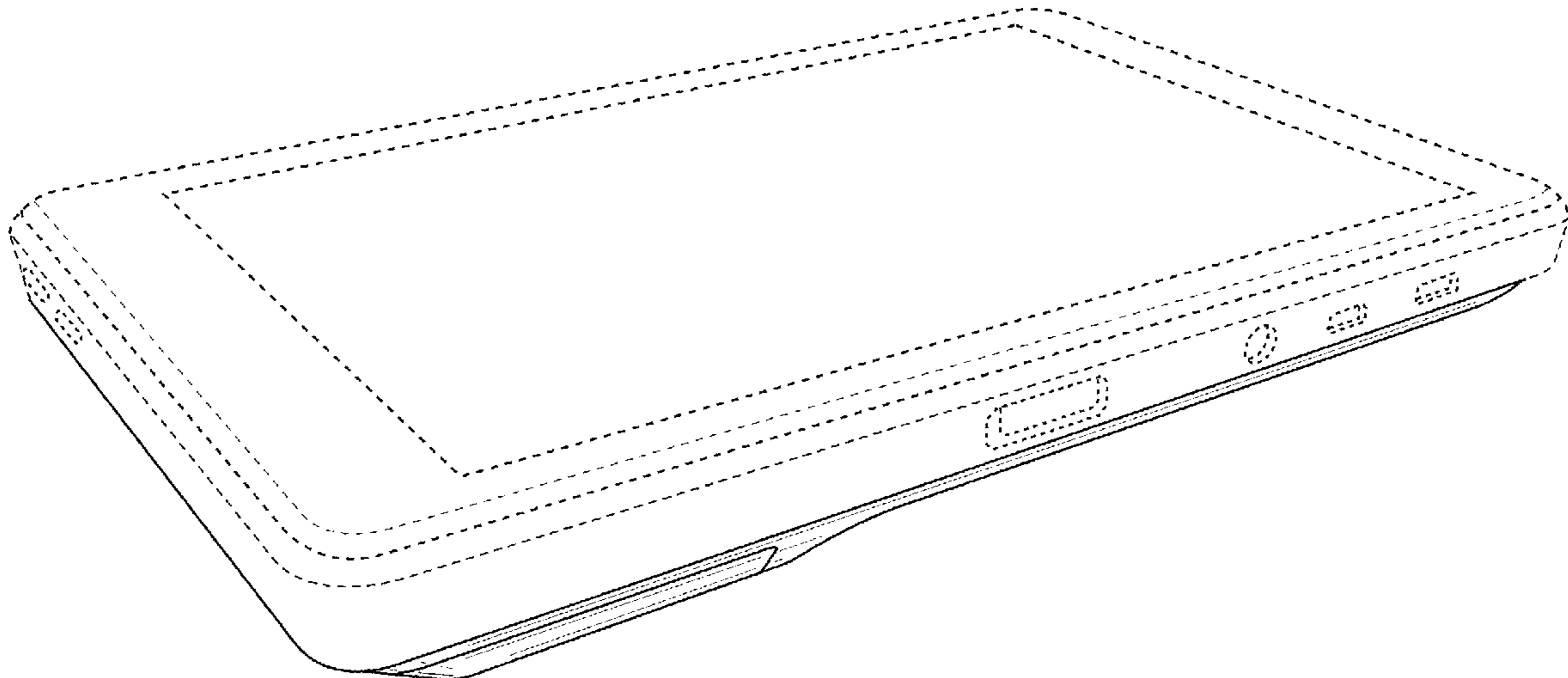
(57) **CLAIM**

The ornamental design for an ultrasound device, as shown  
and described.

**DESCRIPTION**

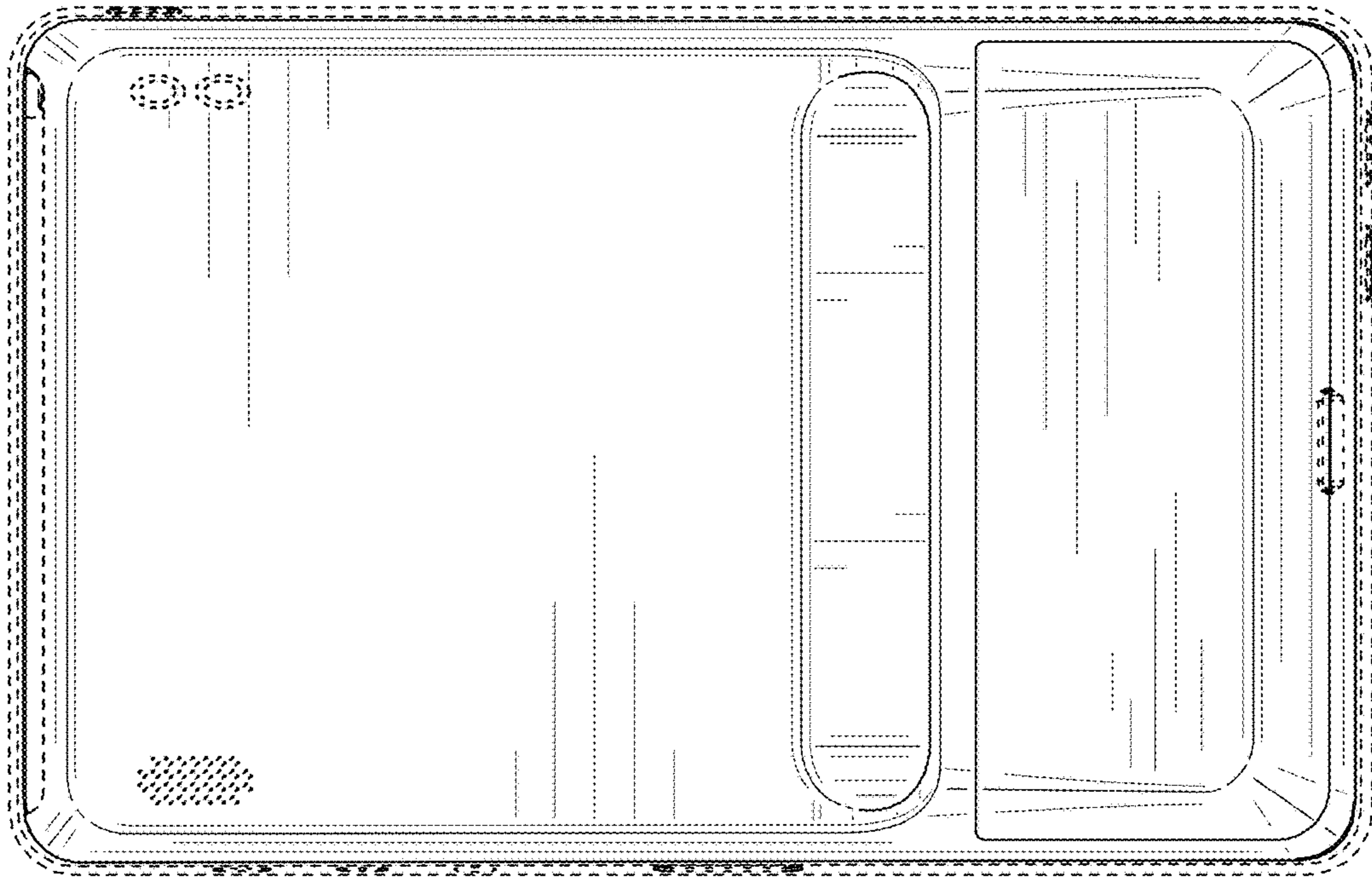
FIG. 1 is top view of an ultrasound device;  
FIG. 2 is an underside view thereof;  
FIG. 3 is a front view thereof;  
FIG. 4 is a rear view thereof;  
FIG. 5 is a first side view thereof.  
FIG. 6 is second side view thereof;  
FIG. 7 is a top perspective view thereof;  
FIG. 8 is an underside perspective view thereof; and,  
FIG. 9 is a side perspective view thereof.  
The broken lines in the drawings are included for the  
purpose of illustrating portions of the ultrasound device that  
form no part of the claimed design.

**1 Claim, 7 Drawing Sheets**

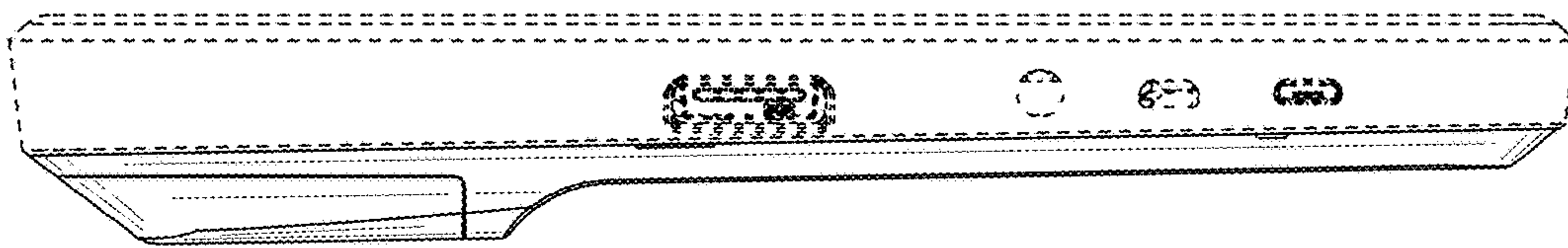




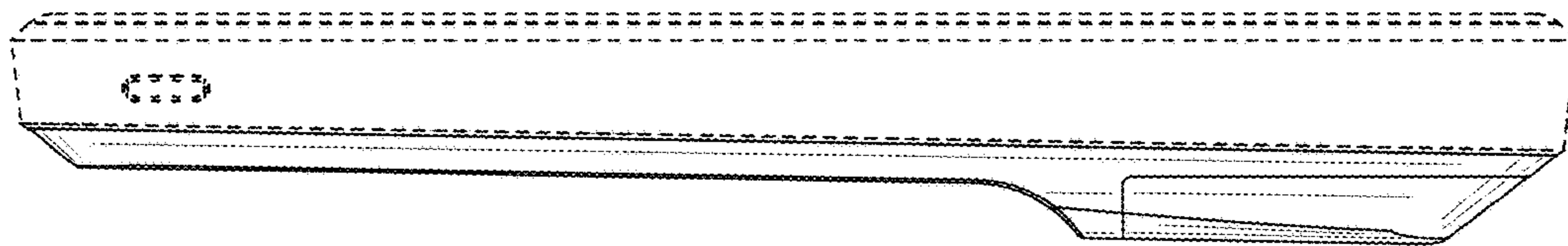
*Fig. 1*



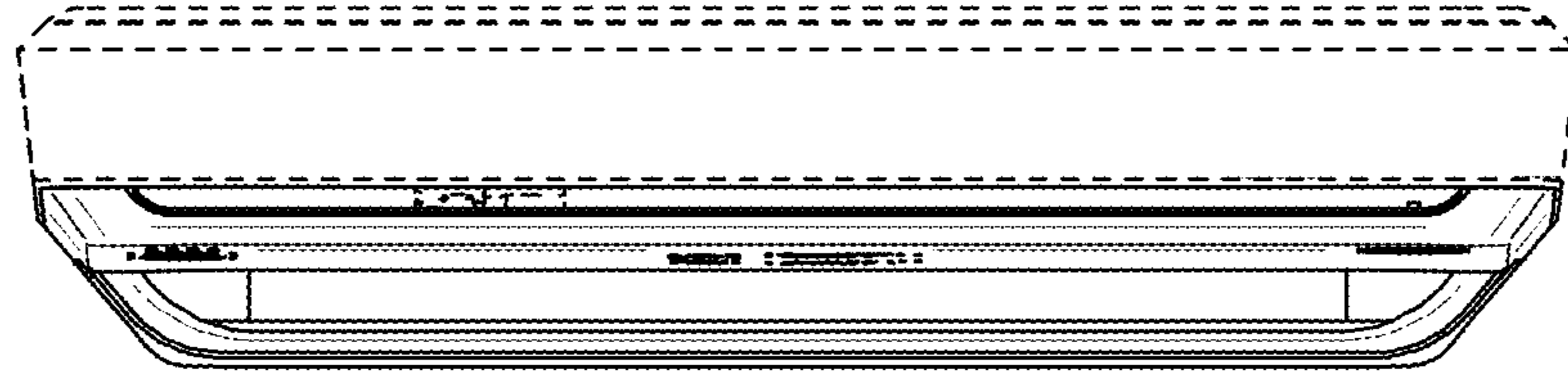
*Fig. 2*



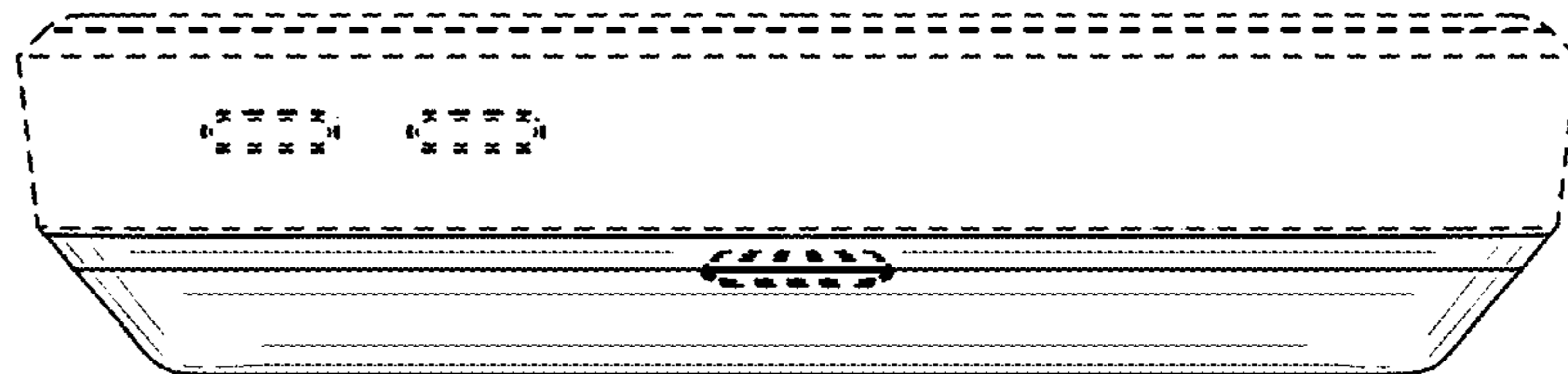
*Fig. 3*



*Fig. 4*



*Fig. 5*



*Fig. 6*

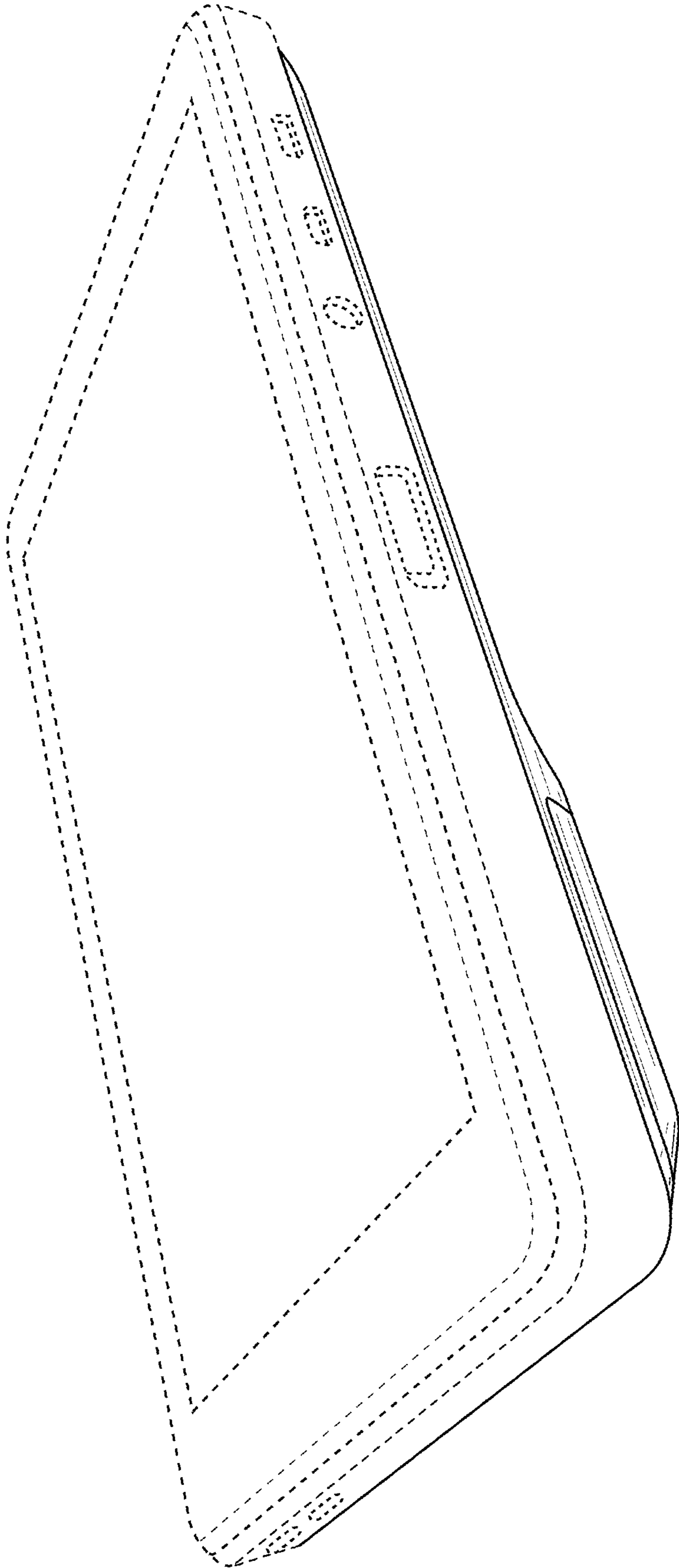


Fig. 7

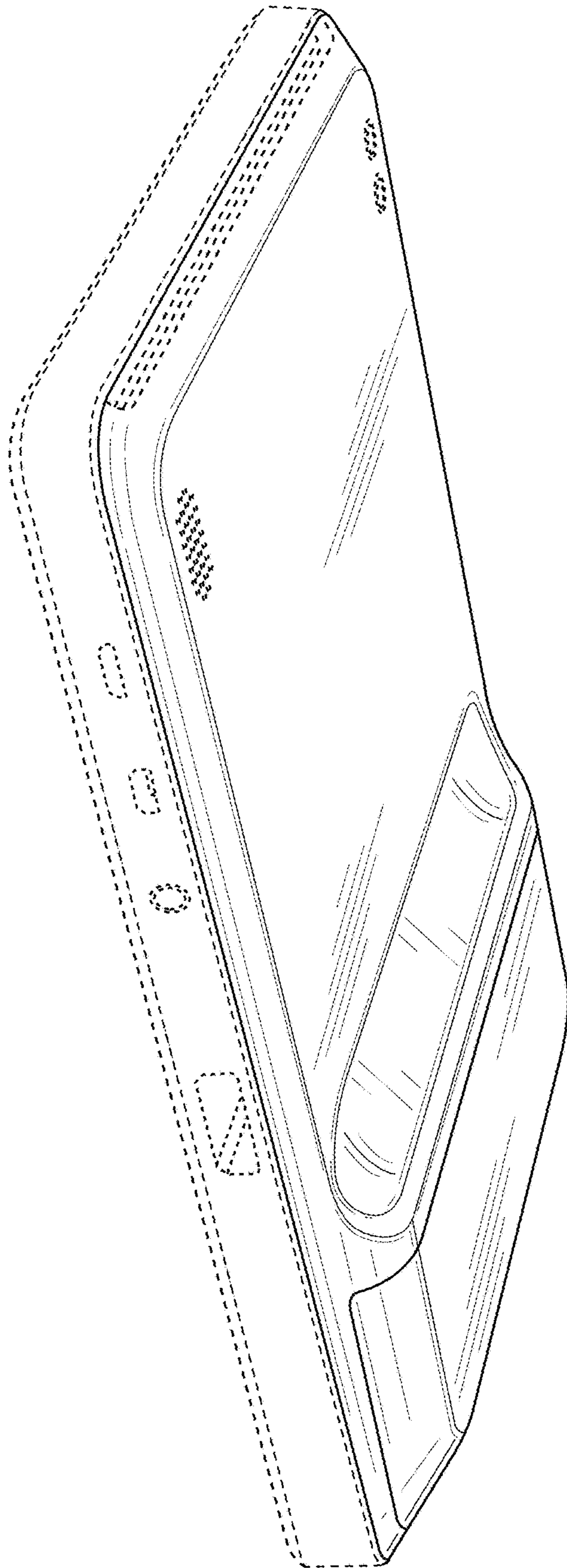


Fig. 8

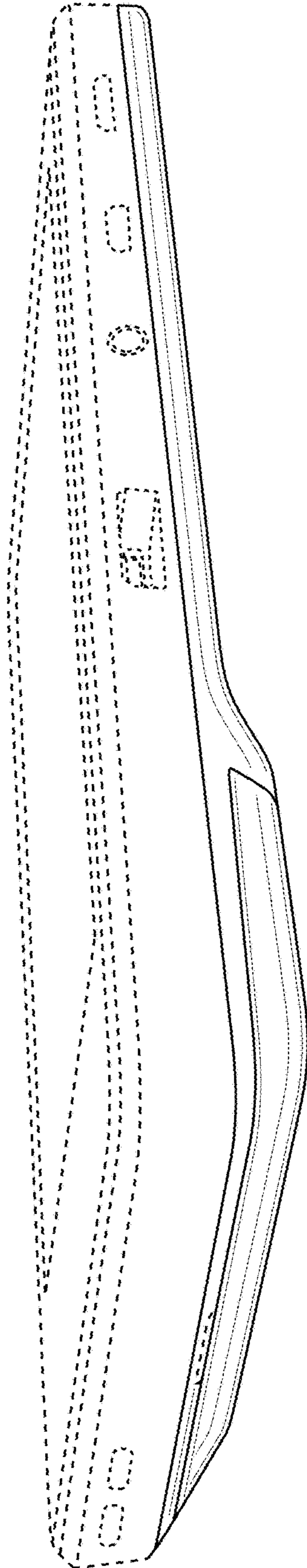


Fig. 9