



US00D834161S

(12) **United States Design Patent** (10) **Patent No.:** **US D834,161 S**
Szolony et al. (45) **Date of Patent:** **** Nov. 20, 2018**

(54) **HEAT EXCHANGER**
(71) Applicant: **TOMTON S.R.O.**, Novy Jicin, Zilina (CZ)
(72) Inventors: **Tomas Szolony**, Zilina (CZ); **Ondrej Sikula**, Zábřdovice (CZ)
(73) Assignee: **TOMTON s.r.o.**, Velké Albrechtice (CZ)
(**) Term: **15 Years**
(21) Appl. No.: **35/501,648**
(22) Filed: **Jul. 22, 2016**
(80) **Hague Agreement Data**
Int. Filing Date: **Jul. 22, 2016**
Int. Reg. No.: **DM/092580**
Int. Reg. Date: **Jul. 22, 2016**
Int. Reg. Pub. Date: **Sep. 30, 2016**

(30) **Foreign Application Priority Data**
Feb. 8, 2016 (EM) 002976878-0001
Feb. 8, 2016 (EM) 002976878-0002
(Continued)
(51) **LOC (11) Cl.** **23-03**
(52) **U.S. Cl.**
USPC **D23/330**
(58) **Field of Classification Search**
USPC D23/317, 314, 332, 333, 334, 335, 337,
D23/342, 351, 355, 378, 370, 381, 364,
D23/336, 341, 330
(Continued)

(56) **References Cited**
U.S. PATENT DOCUMENTS
D359,344 S * 6/1995 De'Longhi D23/317
D397,193 S * 8/1998 Boyle D23/317
(Continued)

Primary Examiner — Darlington Ly

(74) *Attorney, Agent, or Firm* — Grady K. Bergen; Griggs Bergen LLP

(57) **CLAIM**
The ornamental design for a heat exchanger, as shown and described.

DESCRIPTION
2.1 is a top, front, and right side perspective view of a heat exchanger showing our new design;
2.2 is a top, front, and right side perspective view thereof, in which the right panel is removed and not shown;
2.3 is a right side perspective view thereof;
2.4 is a front perspective view thereof;
2.5 is a top perspective view thereof;
2.6 is an enlarged and partial top, front, and right side perspective view thereof; and
2.7 is a bottom, front, and right side perspective view thereof.
4.1 is a top, front, and right side perspective view of a heat exchanger showing our new design in accordance to a second embodiment;
4.2 is a right side perspective view thereof;
4.3 is a bottom, front, and right side perspective view thereof;
4.4 is an enlarged and partial top, front, and right side perspective view thereof;
4.5 is a top, front, and right side perspective view thereof, in which the right panel is removed and not shown; and
4.6 is a top perspective view thereof.
5.1 is a top, front, and right side perspective view of a heat exchanger showing our new design in accordance to a third embodiment;
5.2 is a right side perspective view thereof;
5.3 is a bottom, front, and right side perspective view thereof;
5.4 is an enlarged and partial top, front, and right side perspective view thereof;
5.5 is a top, front, and right side perspective view thereof, in which the right panel is removed and not shown; and
5.6 is a top perspective view thereof.

1 Claim, 10 Drawing Sheets

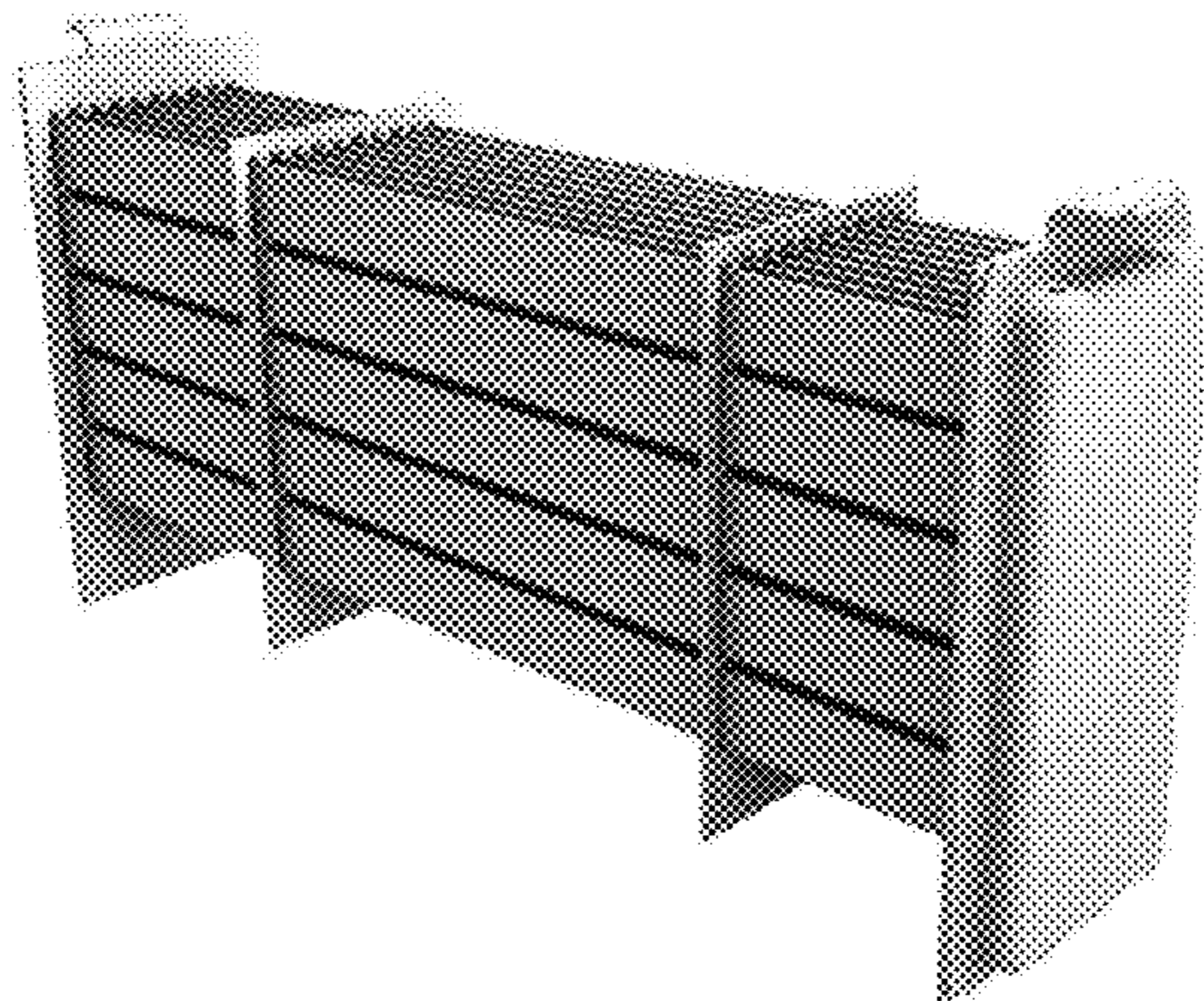

(30) **Foreign Application Priority Data**

Feb. 8, 2016 (EM) 002976878-0003
Feb. 8, 2016 (EM) 002976878-0004
Feb. 8, 2016 (EM) 002976878-0005

(58) **Field of Classification Search**

CPC F24H 3/004; F24H 3/0411; F24H 3/0417;
F24H 3/00; F28D 1/0333
See application file for complete search history.

(56) **References Cited**

U.S. PATENT DOCUMENTS

D423,090 S * 4/2000 Barbosa D23/330
6,443,223 B2 * 9/2002 Ichiyonagi F28D 1/0341
165/153
7,311,138 B2 * 12/2007 Kazari F28D 1/0333
165/153
D624,166 S * 9/2010 Zanolin D23/330
8,184,962 B2 * 5/2012 Zanolin F24D 19/06
392/373
D684,245 S * 6/2013 Dong D23/330

* cited by examiner

2.1

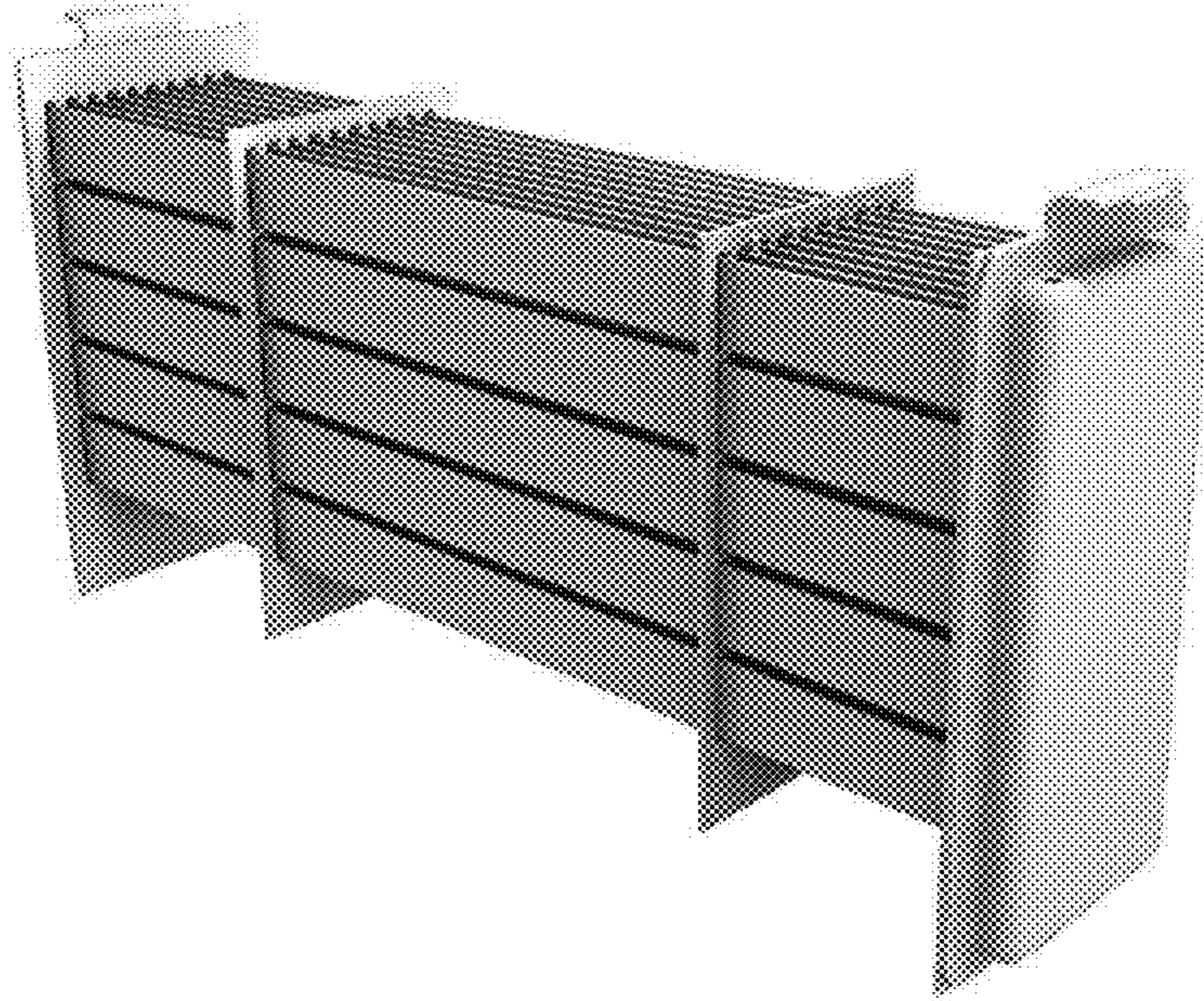

2.2

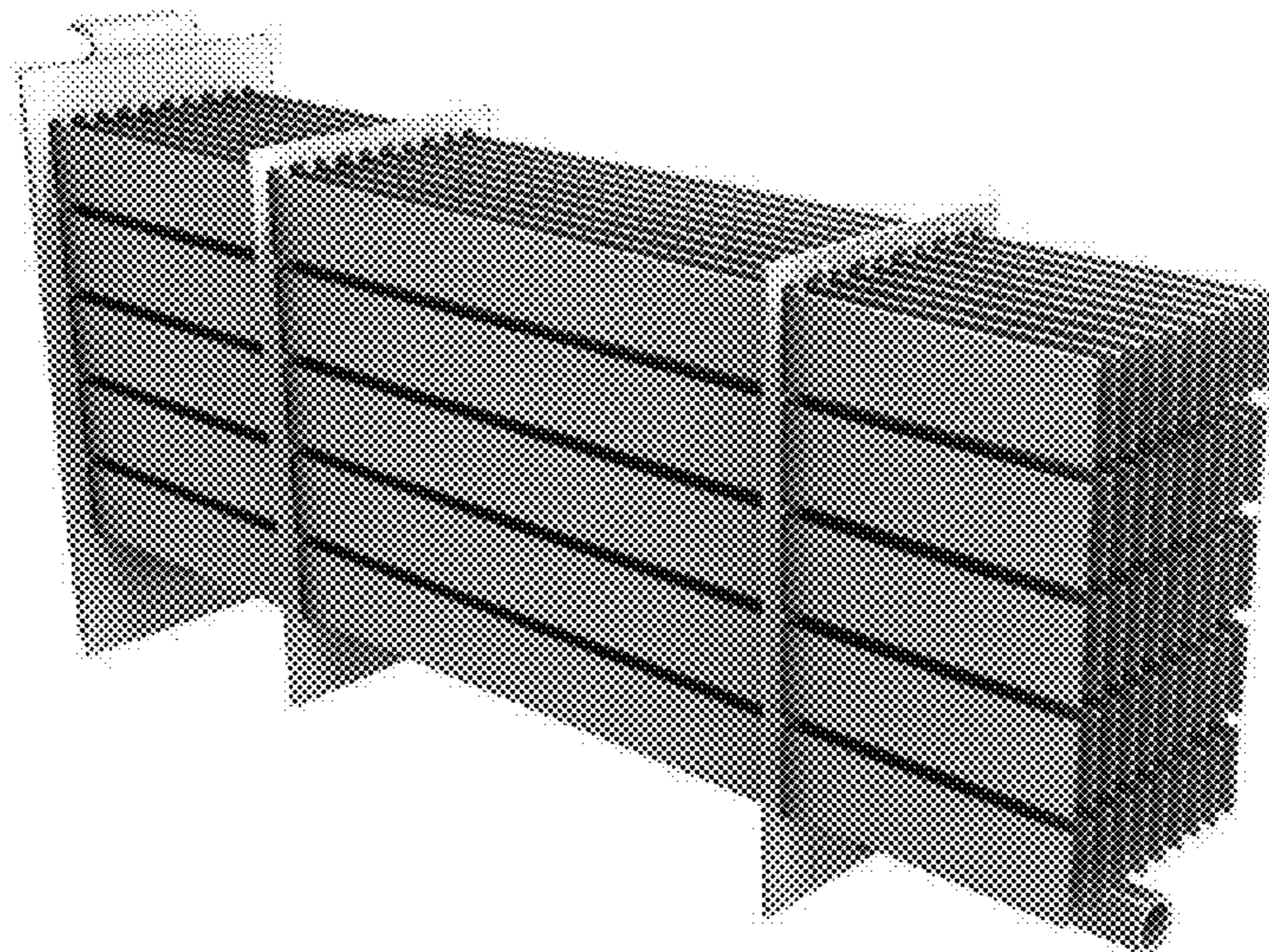

2.3

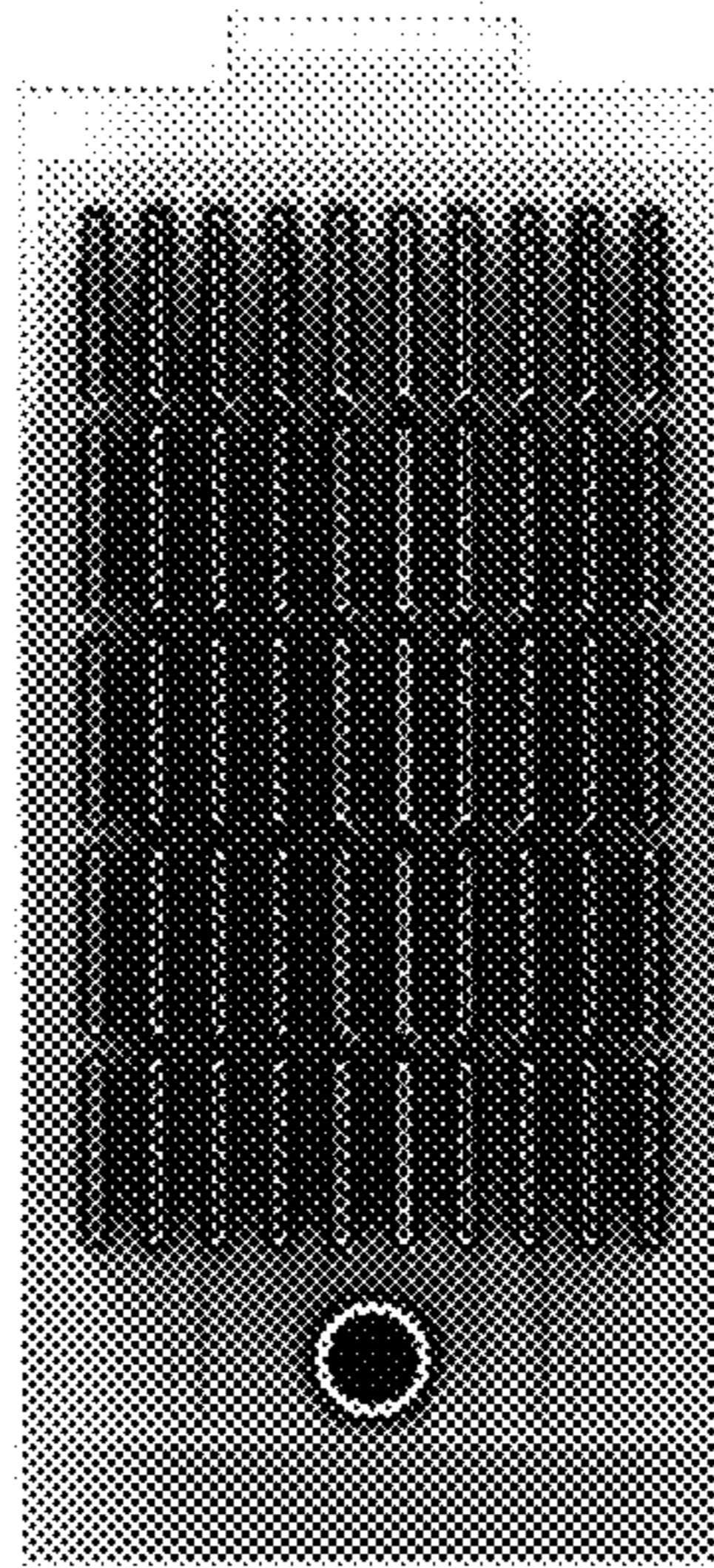

2.4

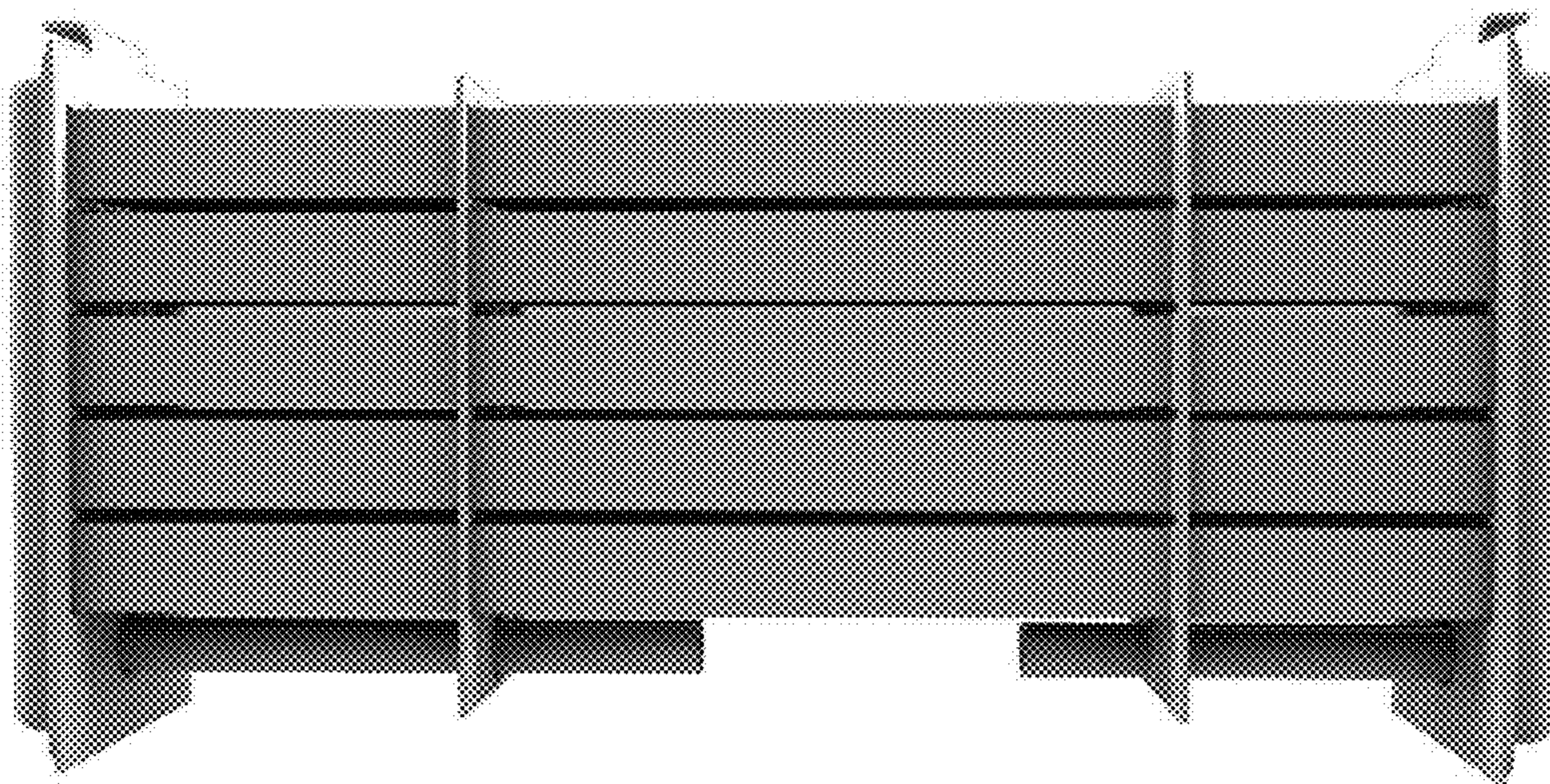

2.5

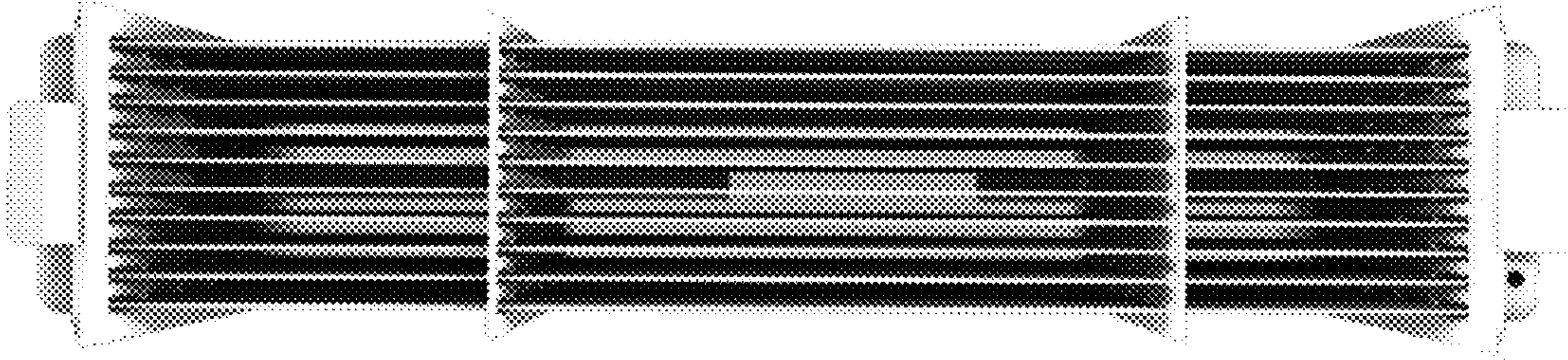

2.6

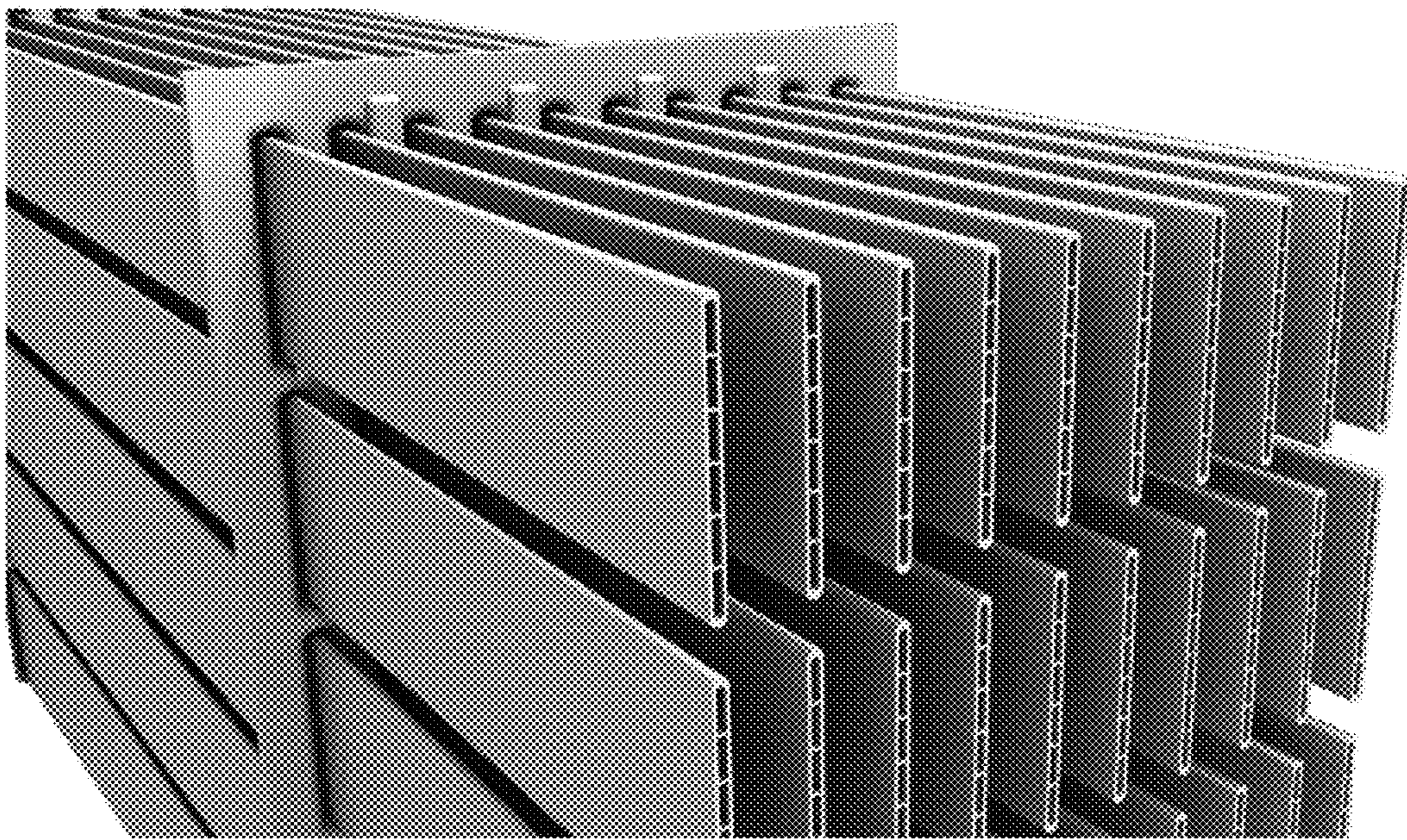

2.7

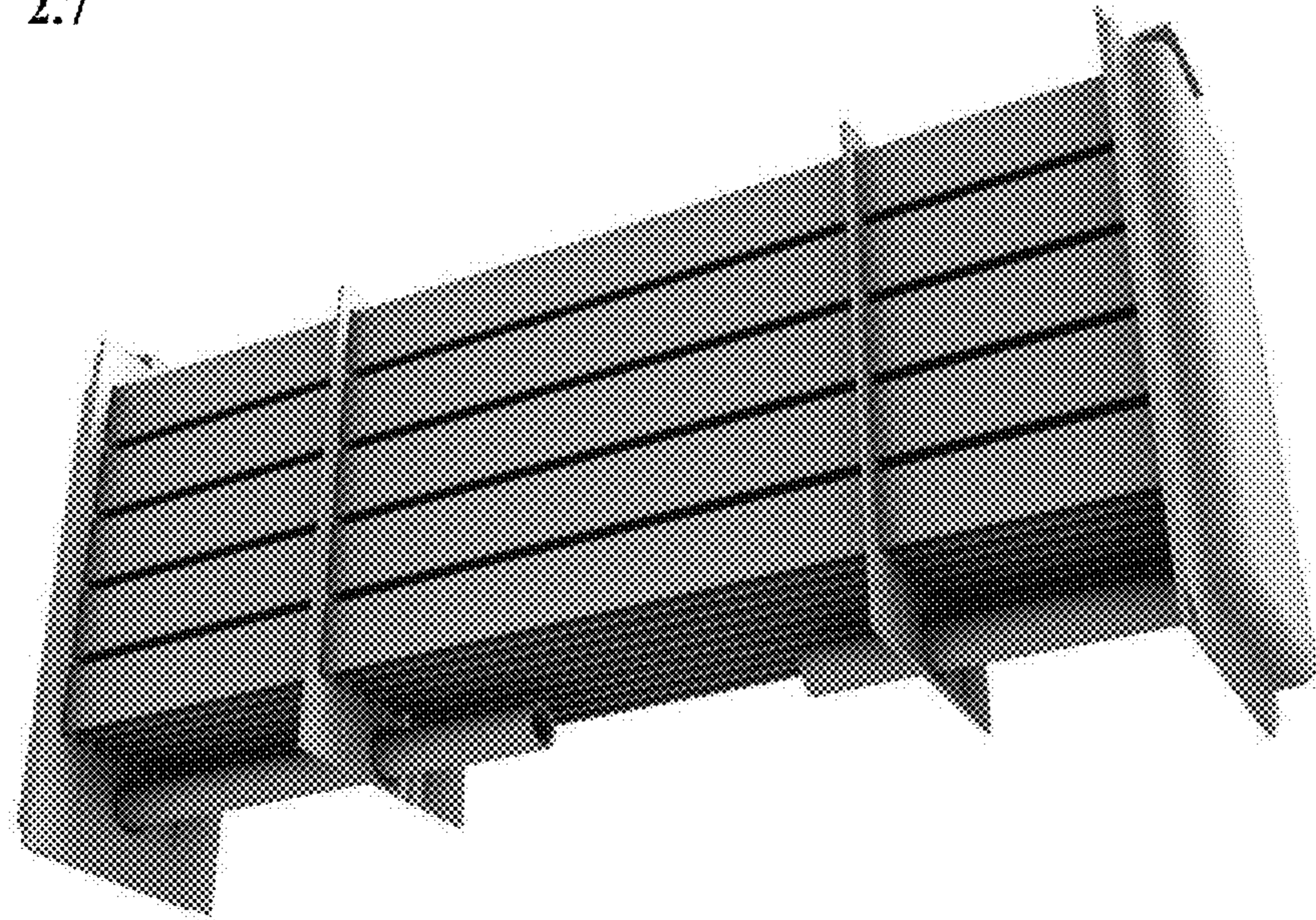

4.1

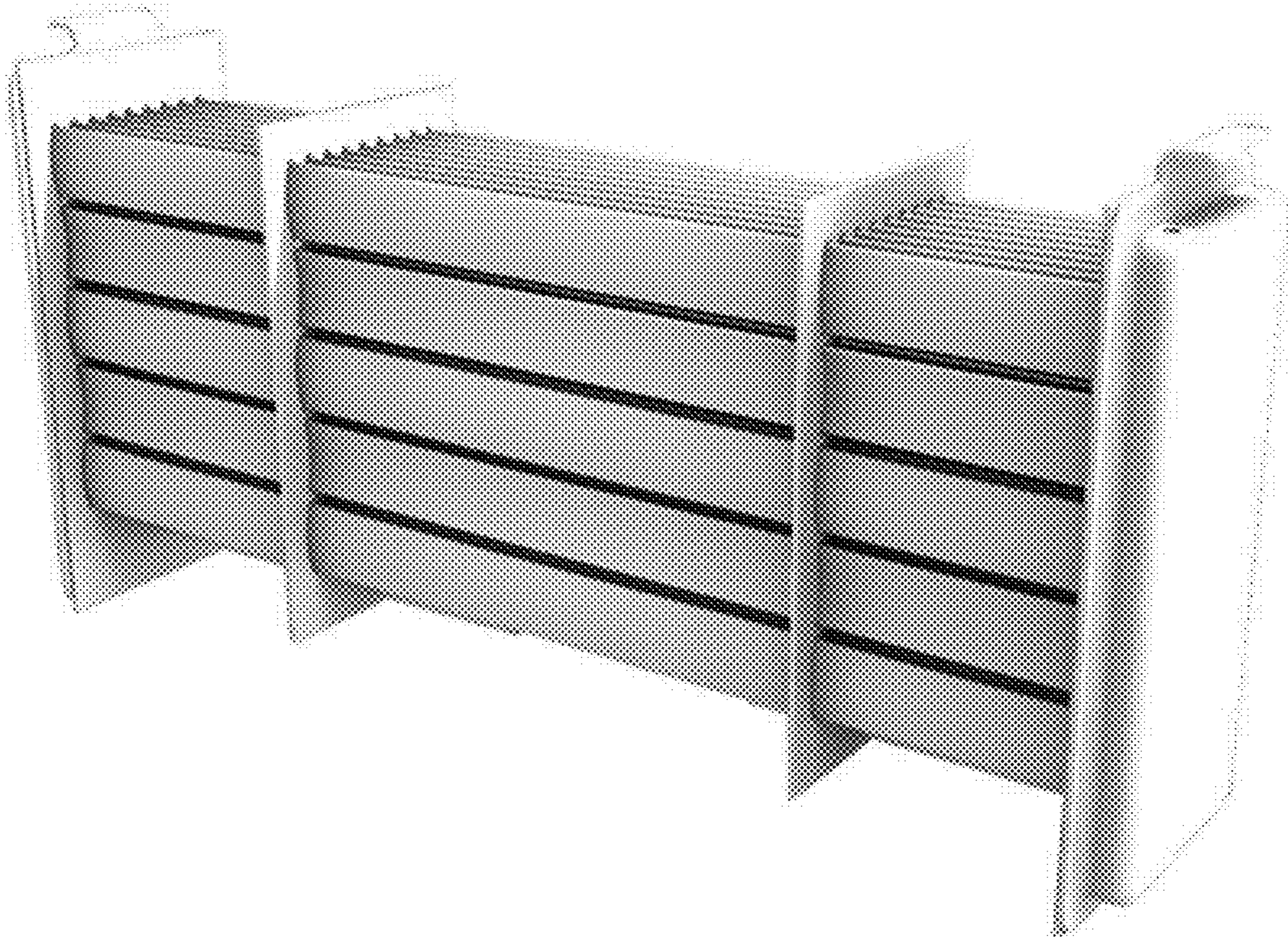

4.2

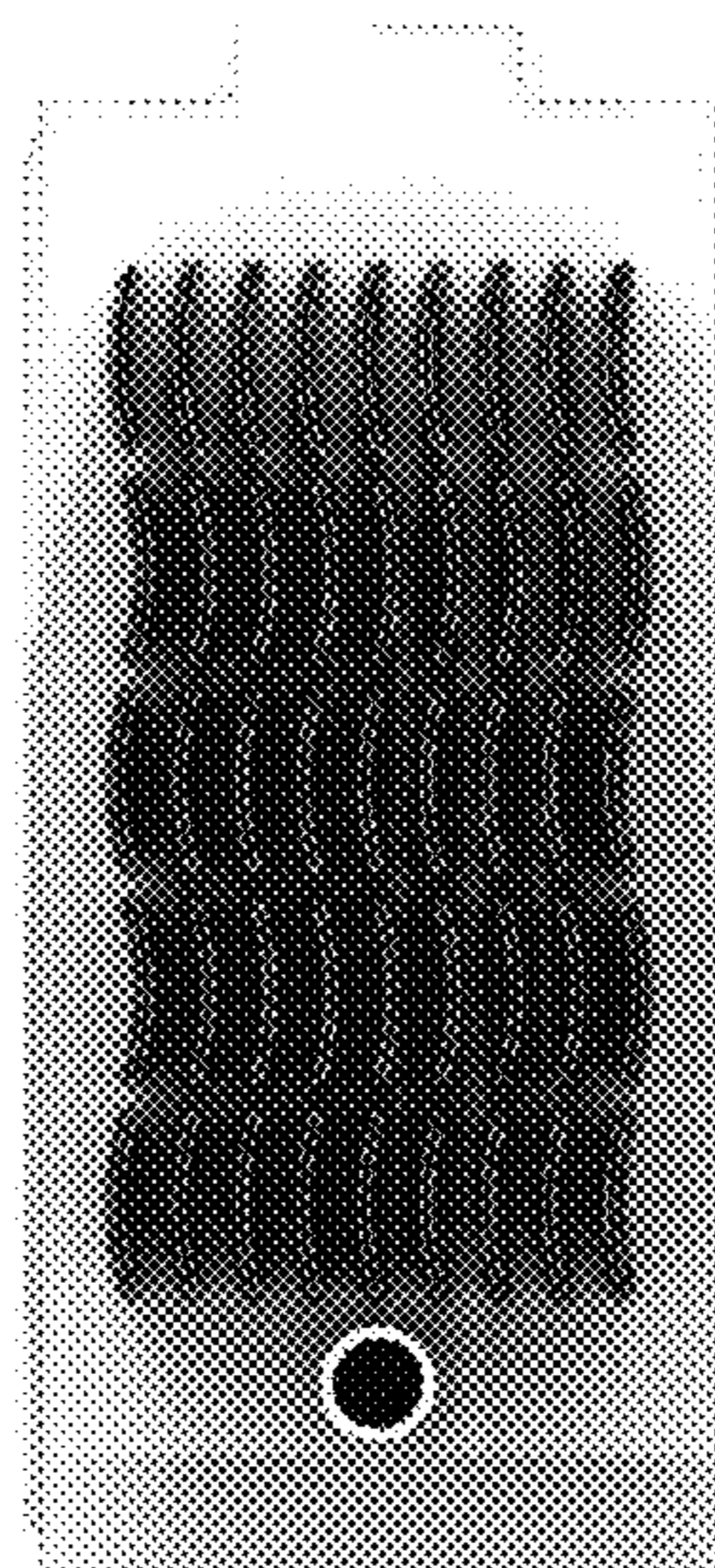

4.3

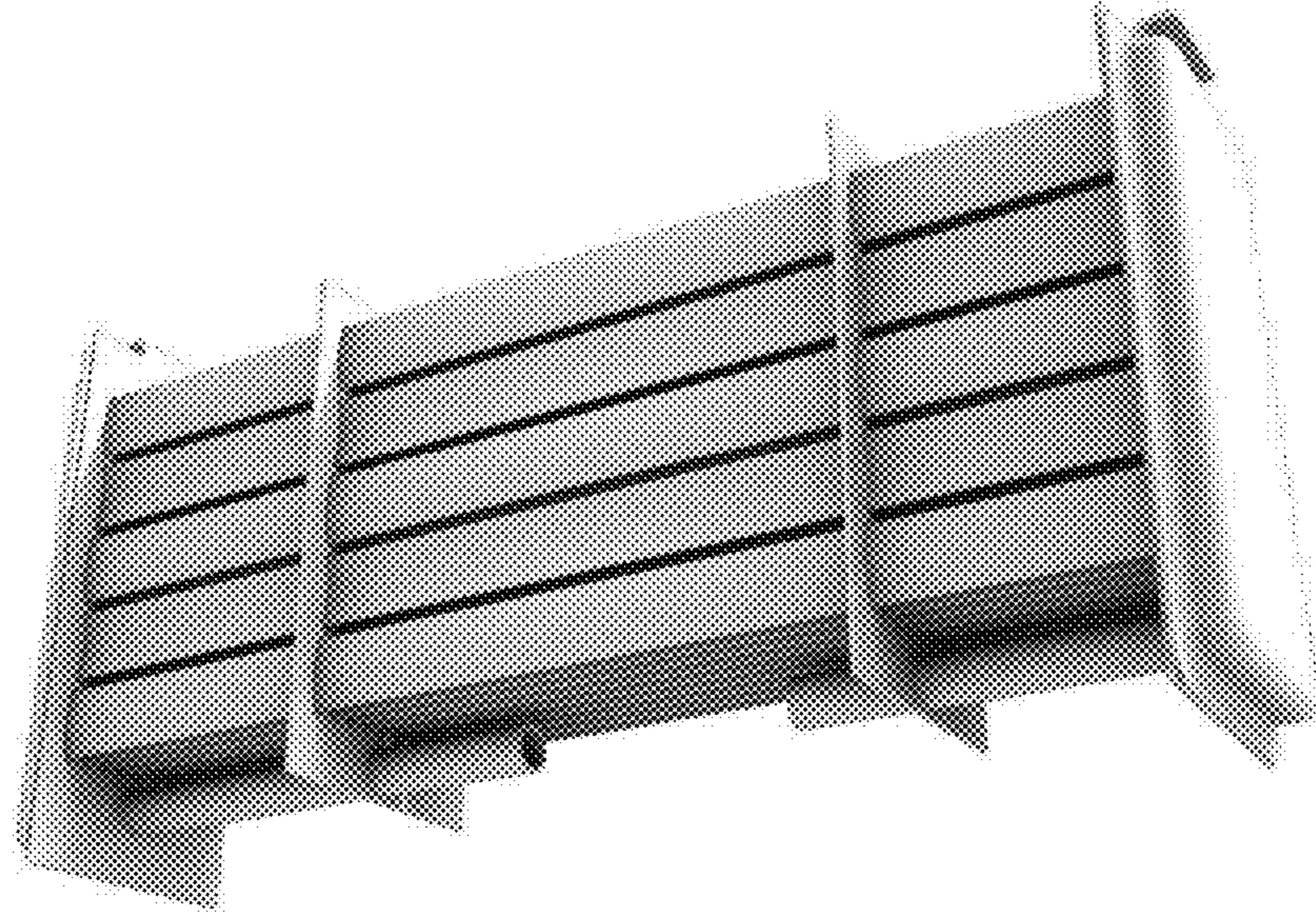

4.4

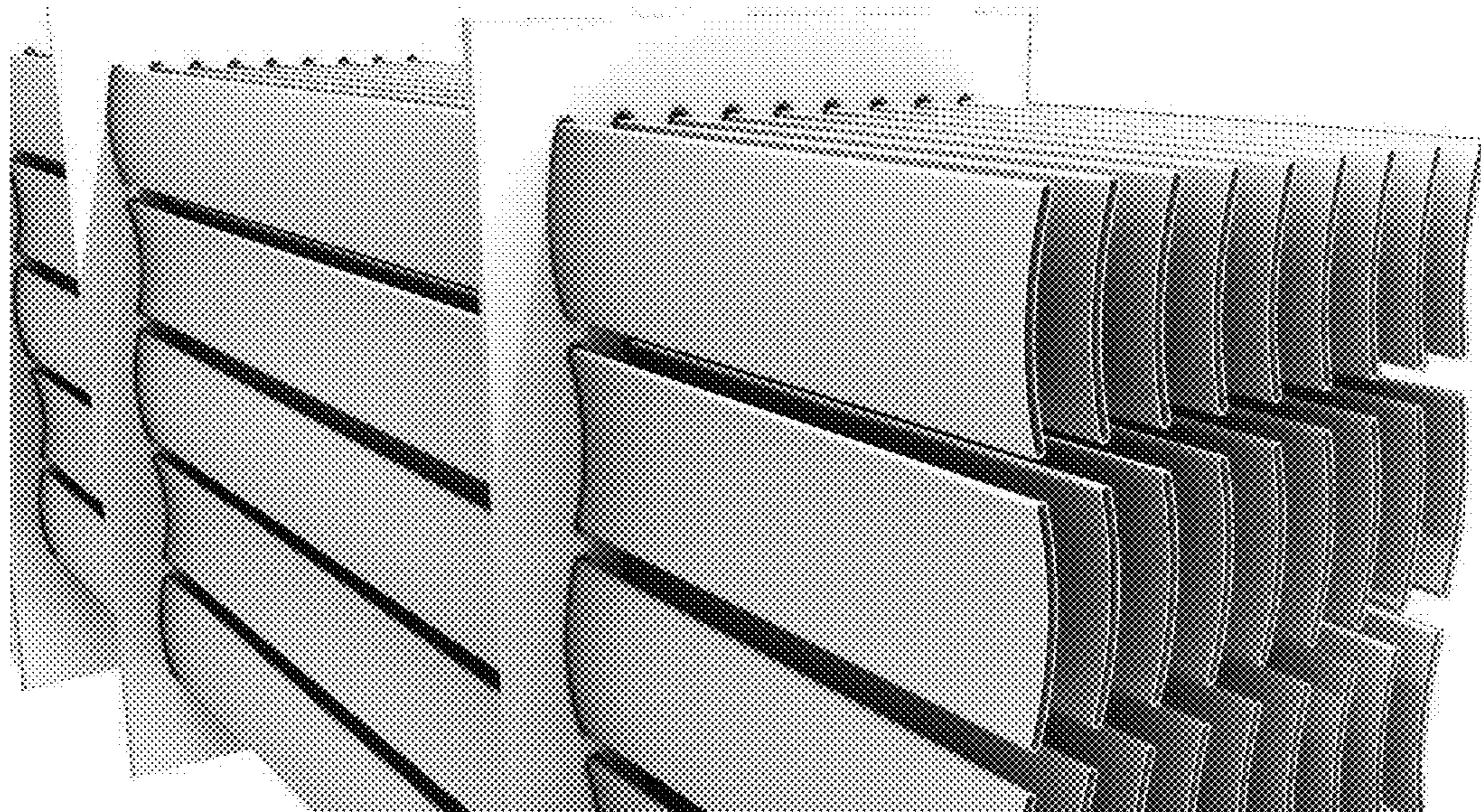

4.5

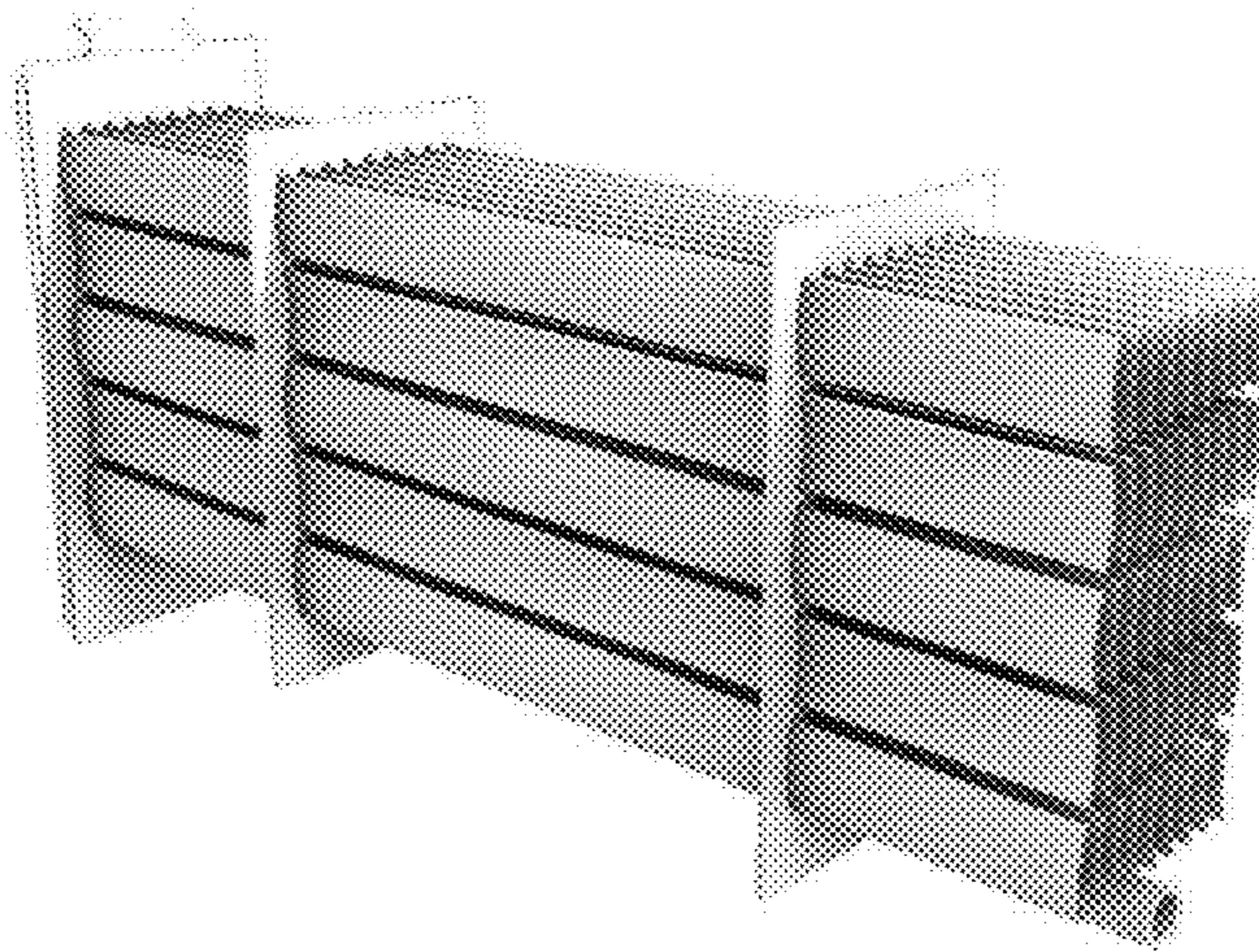

4.6

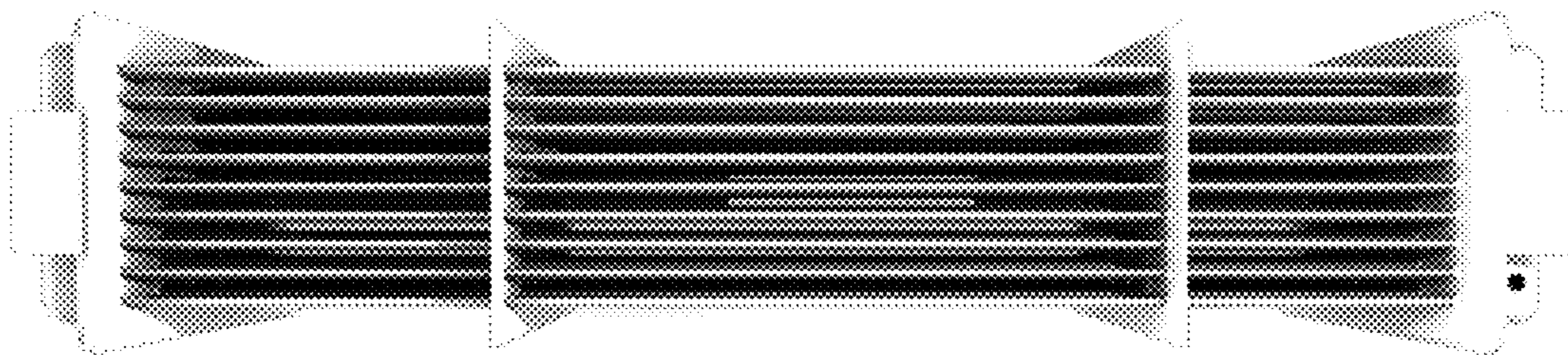

5.1

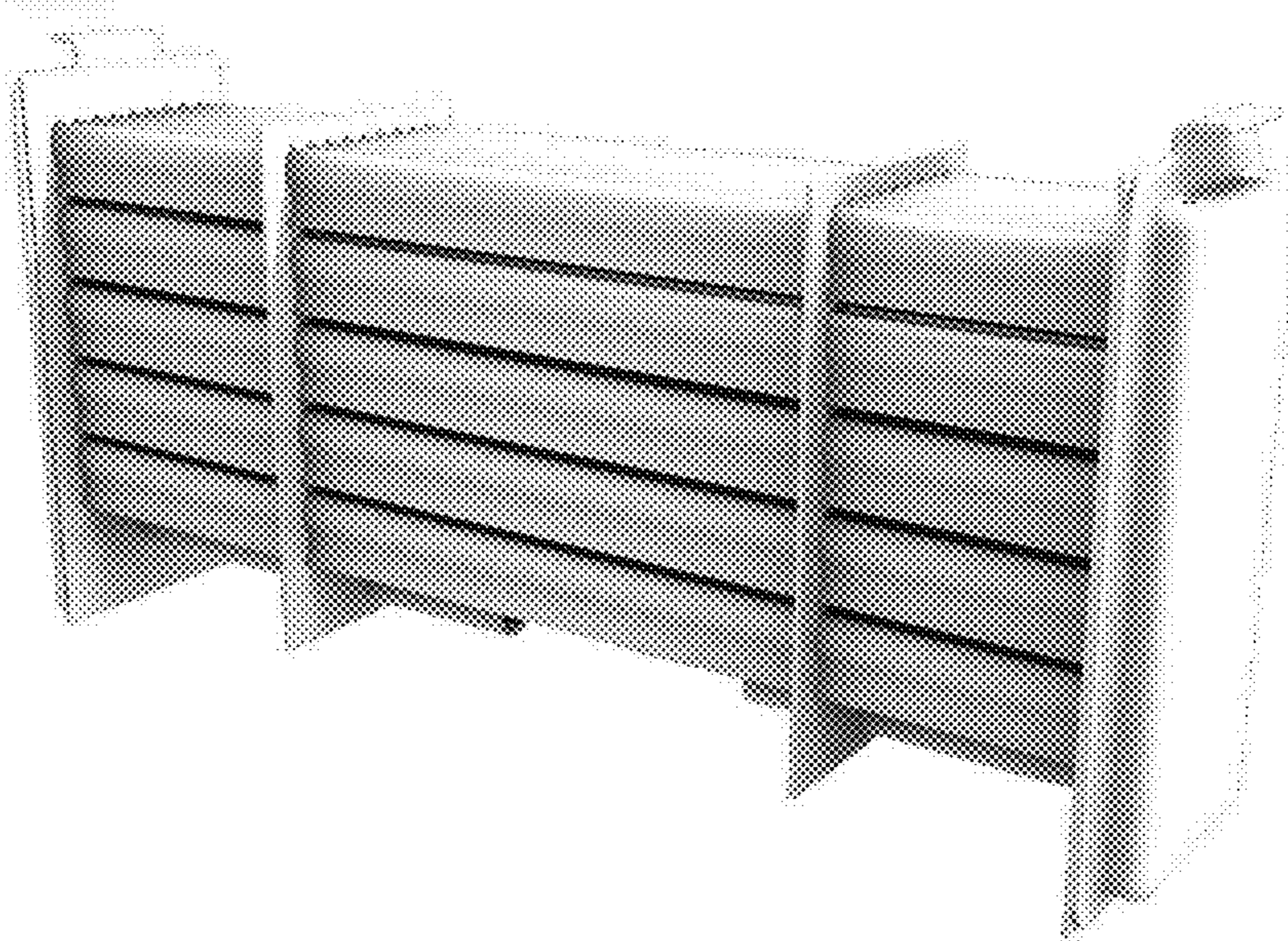

5.2

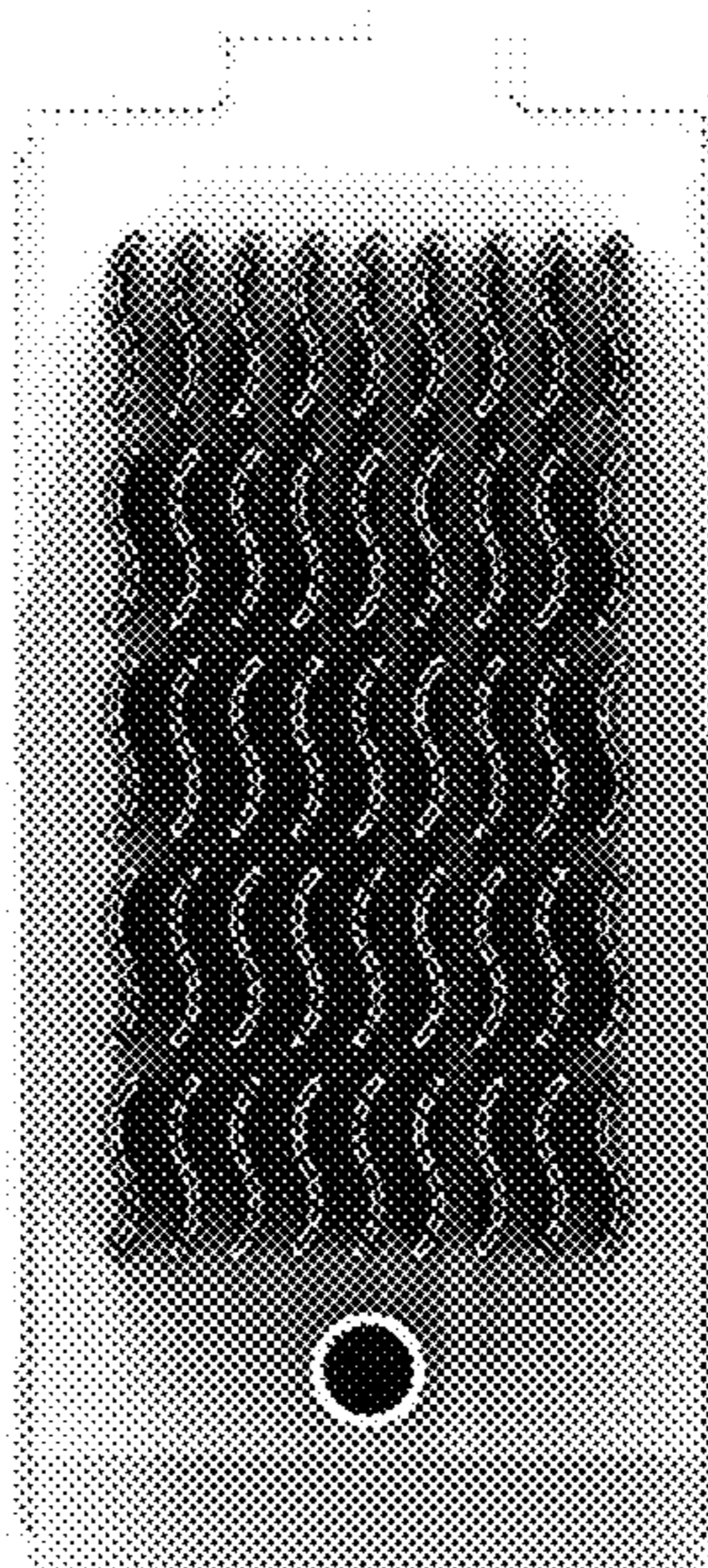

5.3

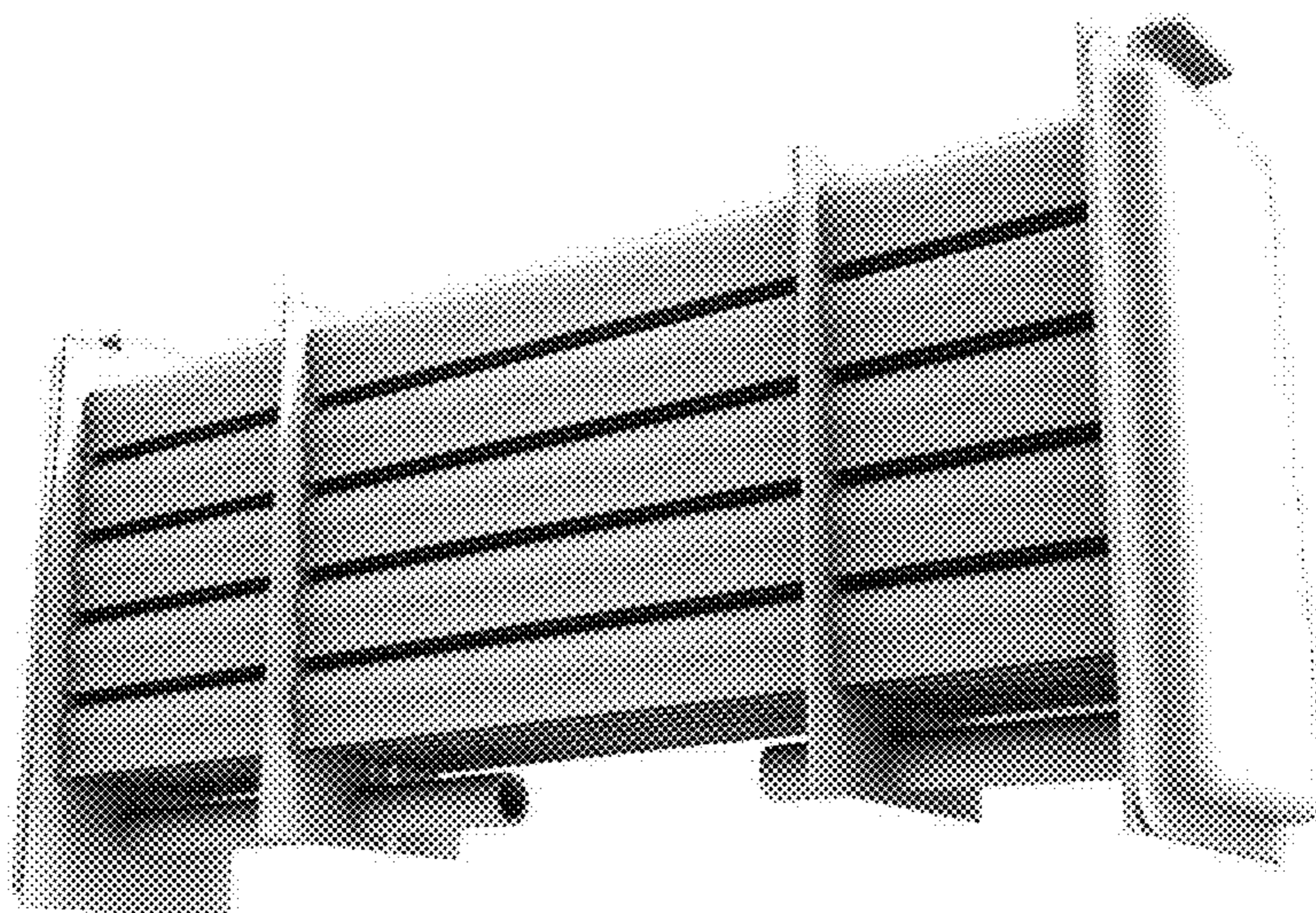

5.4

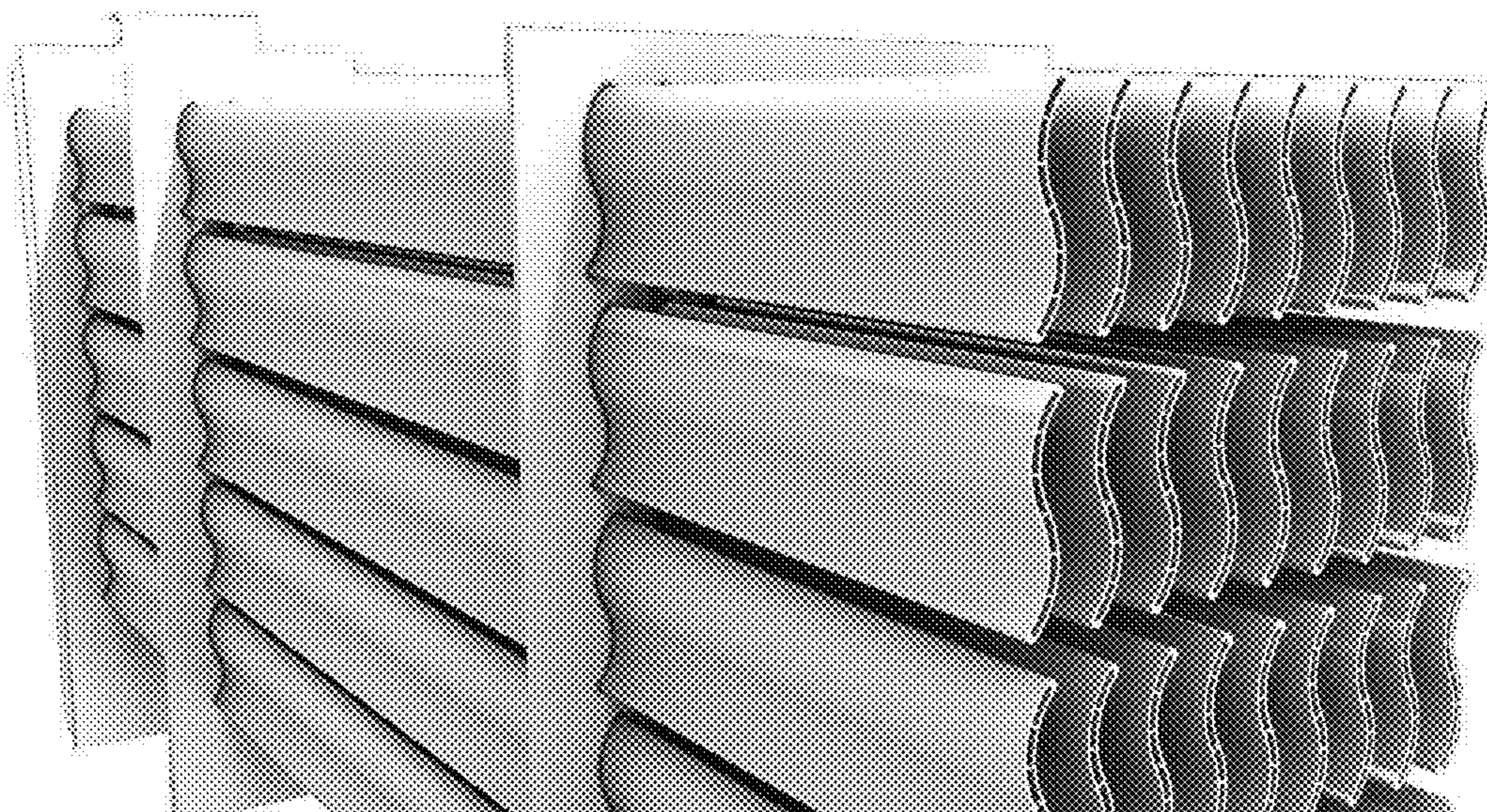

5.5

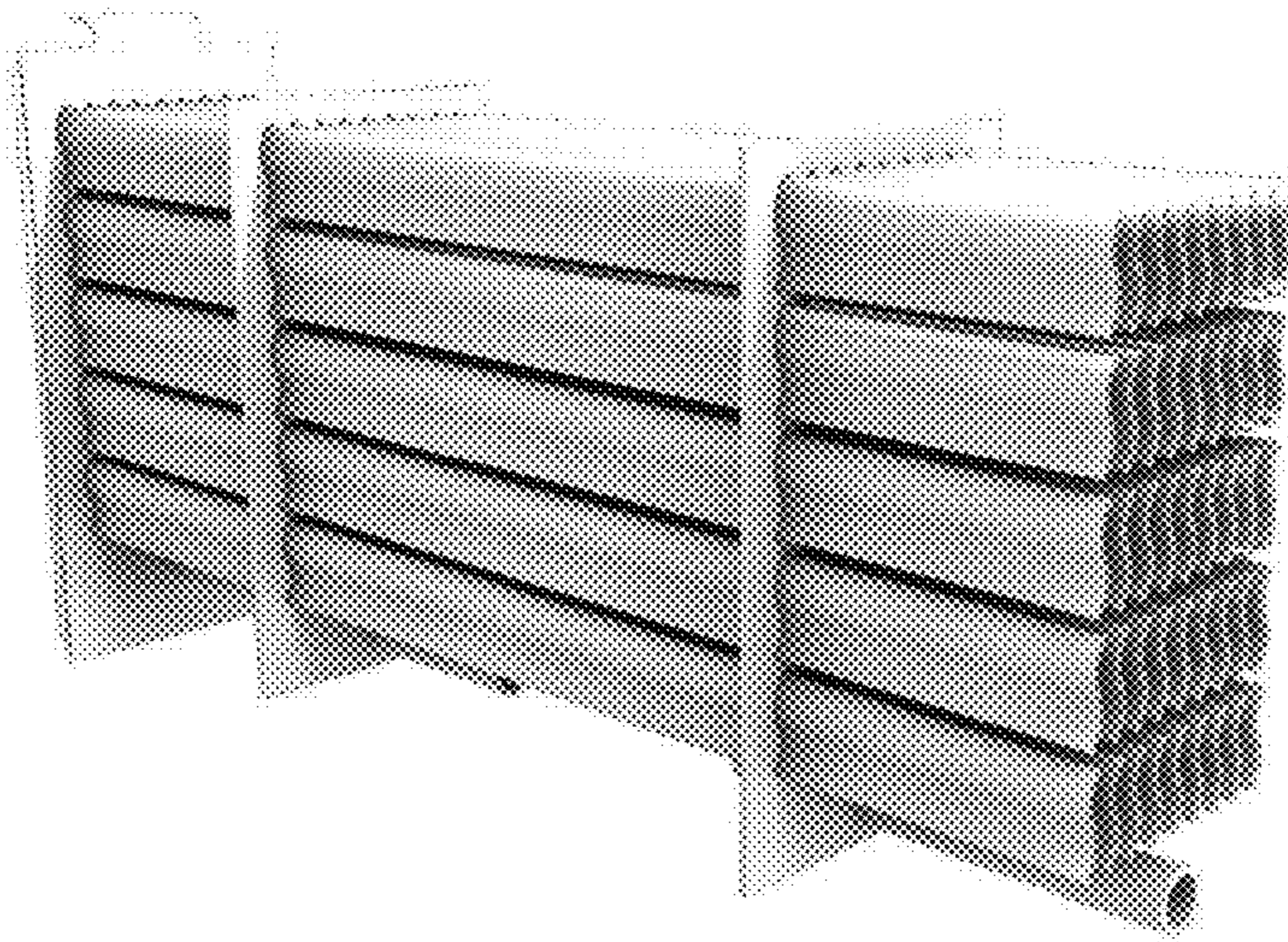

5.6

