



US00D834022S

(12) **United States Design Patent**
Gleeson et al.

(10) **Patent No.:** **US D834,022 S**

(45) **Date of Patent:** **** Nov. 20, 2018**

(54) **INPUT DEVICE WITH TRACK BALL**

(57) **CLAIM**

(71) Applicant: **Logitech Europe S.A.**, Lausanne (CH)

The ornamental design for input device with track ball, as shown and described.

(72) Inventors: **Martin Gleeson**, County Cork (IE);
Sylvain Sauvage, La-Tour-de-Peliz (CH); **Lars Lauridsen**, Lausanne (CH);
Christophe Dayer, Onex (CH); **Cathal Loughnane**, County Wexford (IE);
Bayden Filleul, County Wicklow (IE);
Jasper Phua, Lausanne (CH)

(73) Assignee: **Logitech Europe S.A.**, Lausanne (CH)

(**) Term: **15 Years**

(21) Appl. No.: **29/599,443**

(22) Filed: **Apr. 3, 2017**

(51) **LOC (11) Cl.** **14-02**

(52) **U.S. Cl.**
USPC **D14/409**

(58) **Field of Classification Search**

USPC D14/402–411, 356, 388, 389, 383–385,
D14/417, 426; 345/156–167; 463/36–38;
358/471, 473; 273/148 B
CPC G06F 3/03543; G06F 2203/0333; G06F
3/039; G06F 3/038; G06F 2203/0384
See application file for complete search history.

(56) **References Cited**

U.S. PATENT DOCUMENTS

D331,398 S * 12/1992 Clouss D14/417
D333,818 S * 3/1993 Yang D14/417
D335,658 S * 5/1993 Barry D14/417
D410,638 S * 6/1999 Sheehan D14/409
D415,746 S * 10/1999 Edwards D14/409

(Continued)

Primary Examiner — Austin Murphy

(74) *Attorney, Agent, or Firm* — Kilpatrick Townsend & Stockton LLP

DESCRIPTION

FIG. 1 is a perspective view of input device with track ball showing our new design in a first configuration with no incline;

FIG. 2 is a second perspective view thereof;

FIG. 3 is a top plan view thereof;

FIG. 4 is a bottom plan view thereof;

FIG. 5 is a front elevation view thereof;

FIG. 6 is a rear elevation view thereof;

FIG. 7 is a left side elevation view thereof;

FIG. 8 is a right side elevation view thereof;

FIG. 9 is a third perspective view thereof with a cover removed from the bottom;

FIG. 10 is a fourth perspective view thereof with the cover removed from the bottom; and

FIG. 11 is a bottom plan view thereof with the cover removed from the bottom.

FIG. 12 is a perspective view of input device with track ball showing our new design in a second configuration with an incline;

FIG. 13 is a second perspective view thereof;

FIG. 14 is a top plan view thereof;

FIG. 15 is a bottom plan view thereof;

FIG. 16 is a front elevation view thereof;

FIG. 17 is a rear elevation view thereof;

FIG. 18 is a left side elevation view thereof;

FIG. 19 is a right side elevation view thereof;

FIG. 20 is a third perspective view thereof with a cover removed from the bottom;

FIG. 21 is a fourth perspective view thereof with the cover removed from the bottom; and,

FIG. 22 is a bottom plan view thereof with the cover removed from the bottom.

The broken lines shown in the figures form no part of the claimed design.

1 Claim, 12 Drawing Sheets

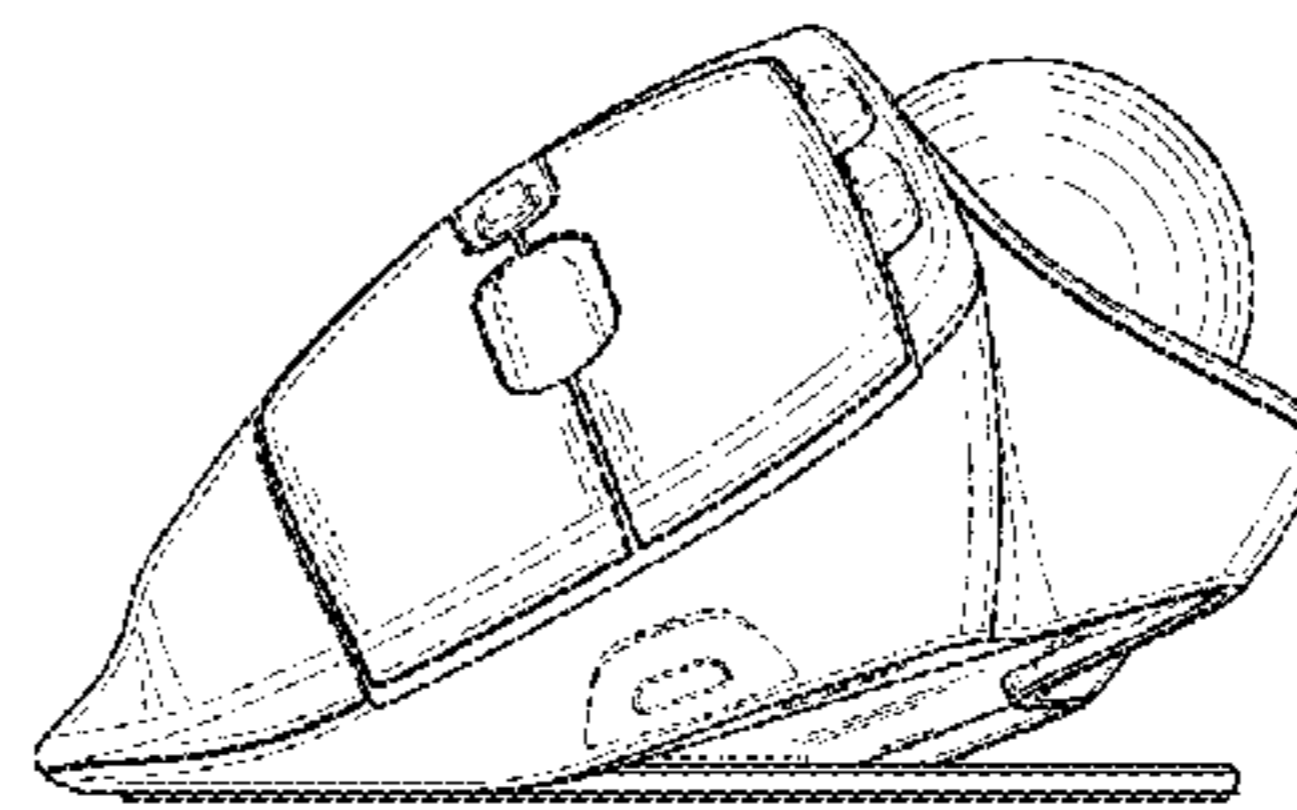
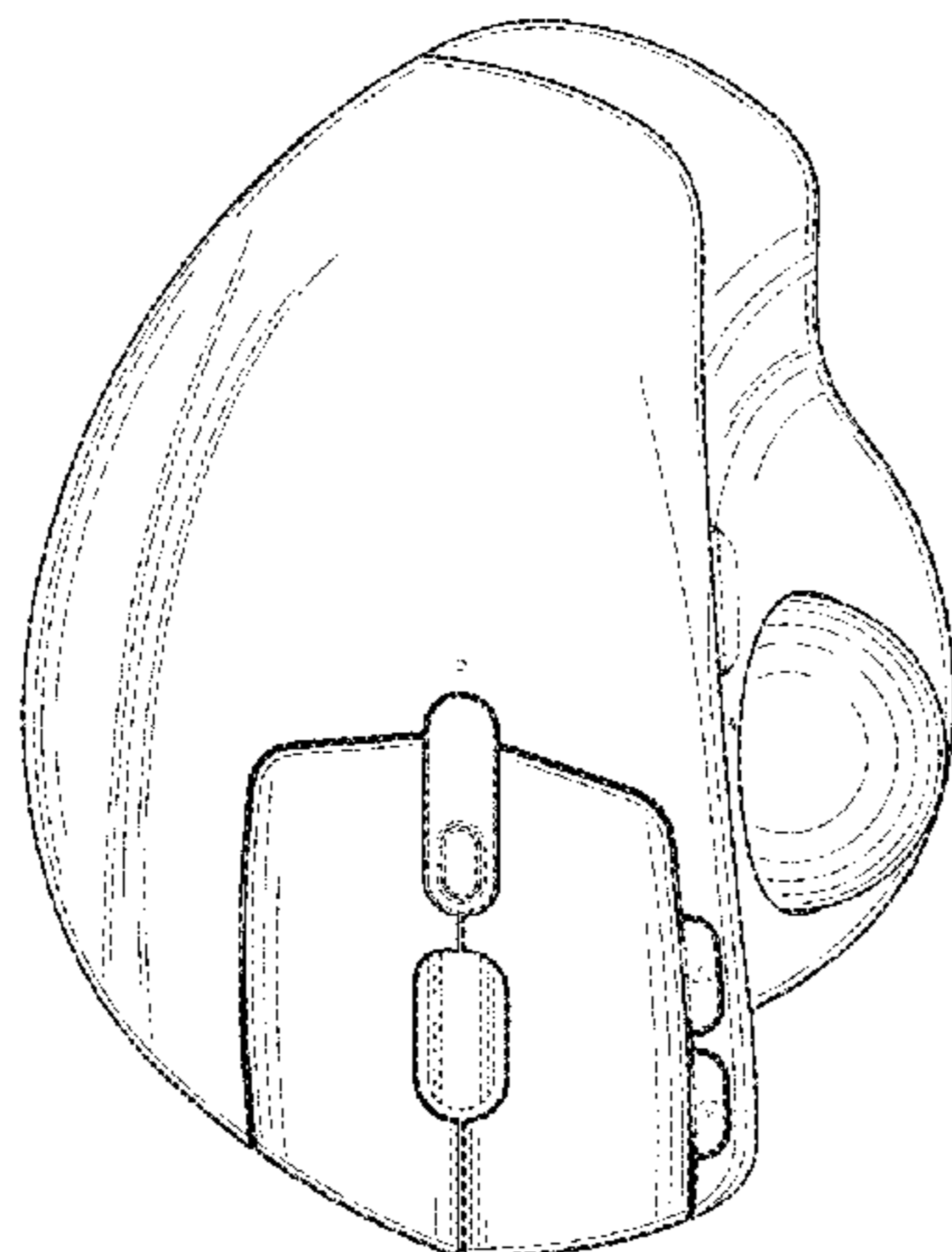

(56)

References Cited

U.S. PATENT DOCUMENTS

6,031,518 A * 2/2000 Adams G06F 3/03543
345/156
D432,131 S * 10/2000 Jones D14/402
6,590,564 B1 * 7/2003 McLoone G06F 3/03549
345/156
D514,570 S * 2/2006 Ohta D14/384
7,286,114 B2 * 10/2007 Lee G06F 3/03543
345/156
D667,409 S * 9/2012 Kujawski D14/409
D681,039 S * 4/2013 Altaai D14/409
D716,813 S * 11/2014 Deng D14/409
D753,116 S * 4/2016 Lo D14/409
D804,480 S * 12/2017 Deng D14/409

* cited by examiner

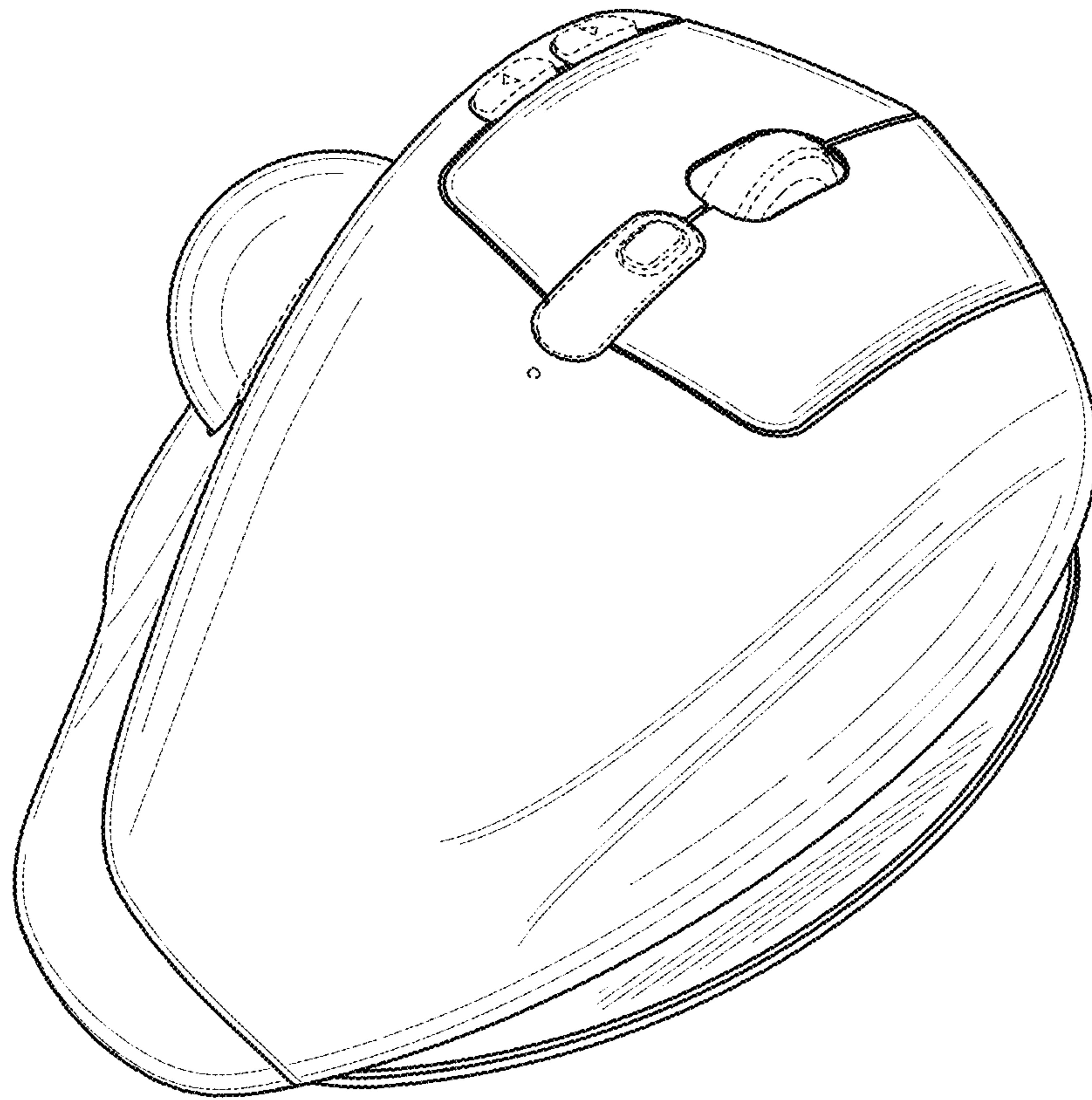

FIG. 1

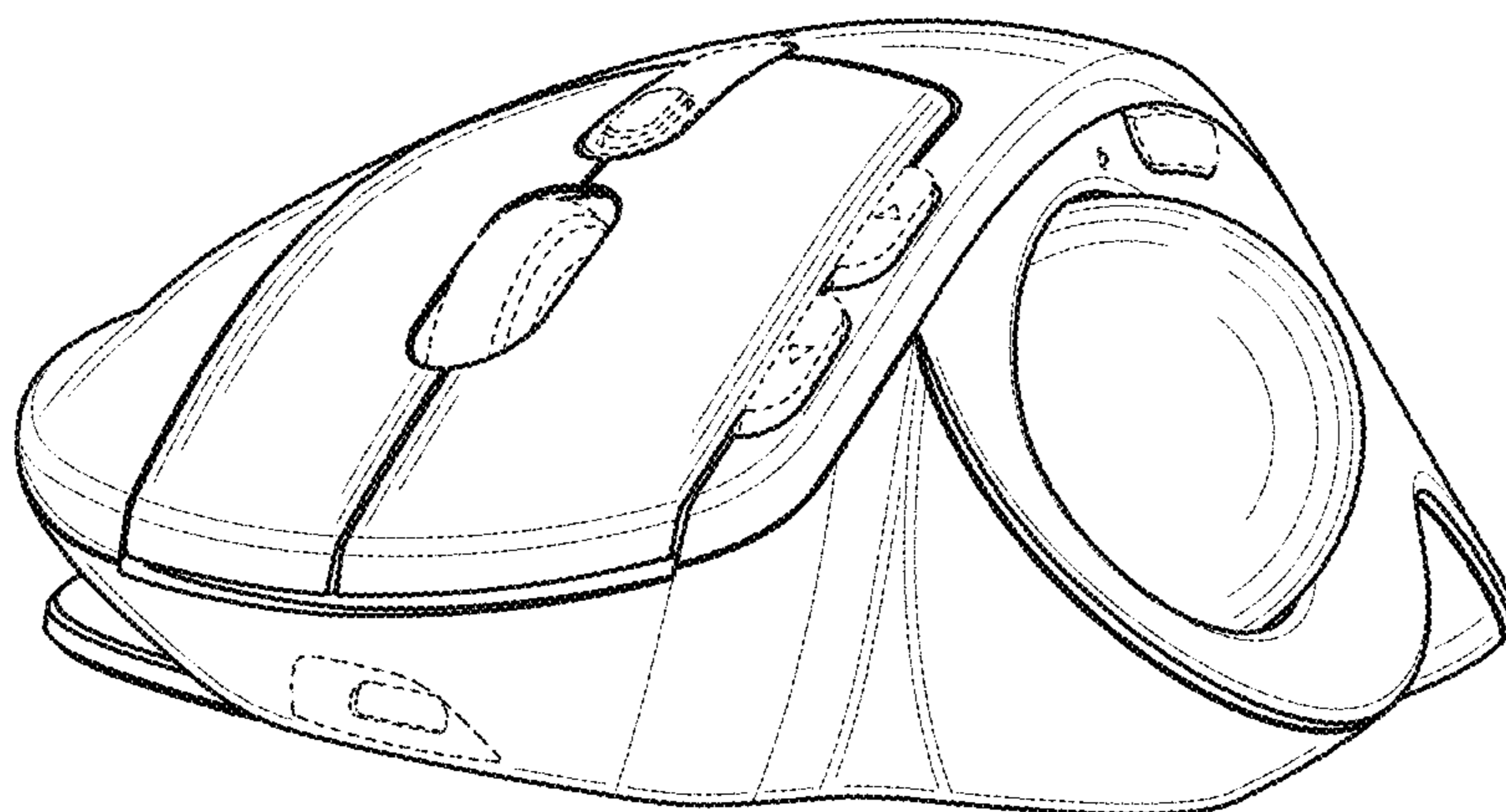

FIG. 2

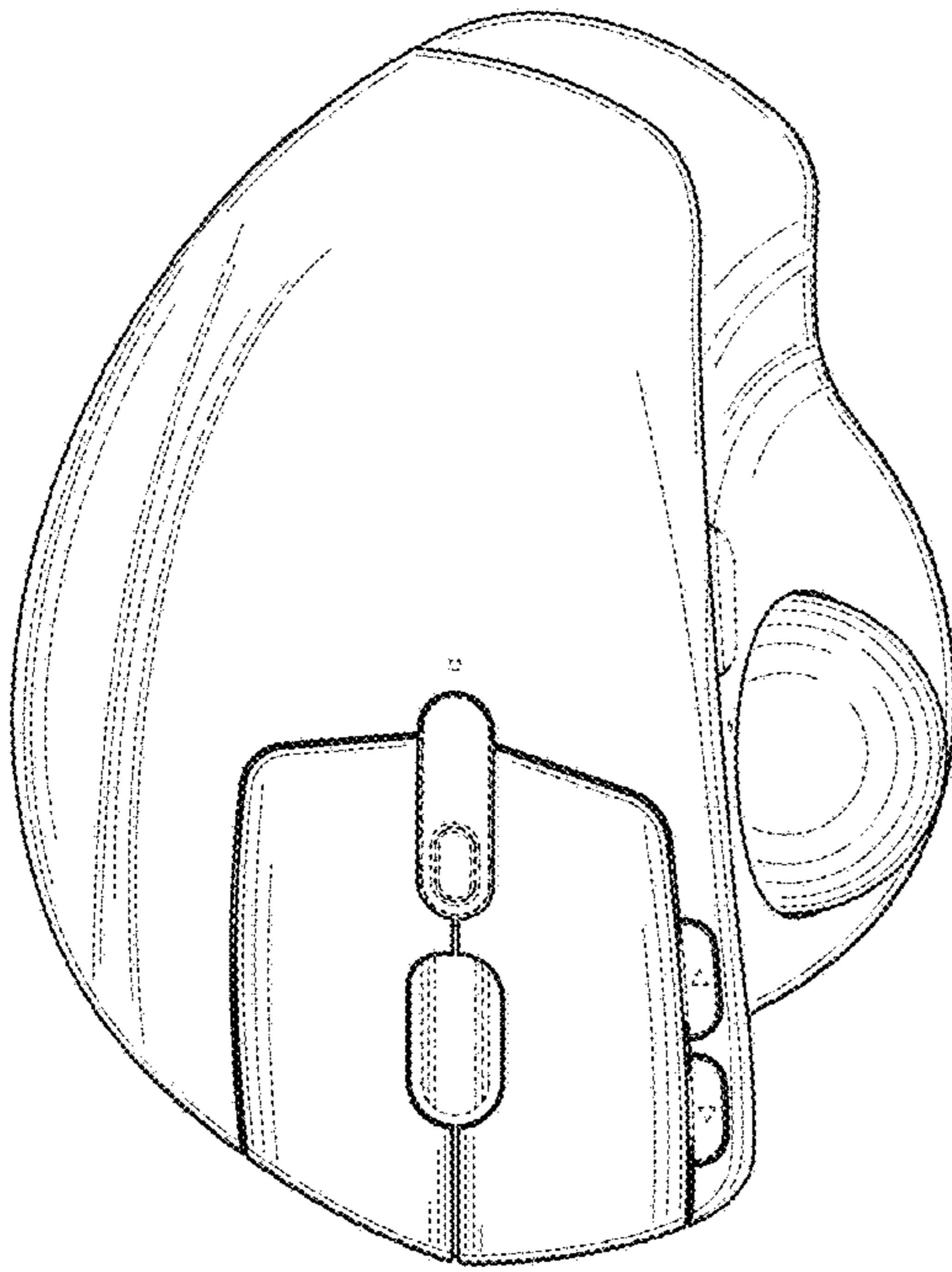

FIG. 3

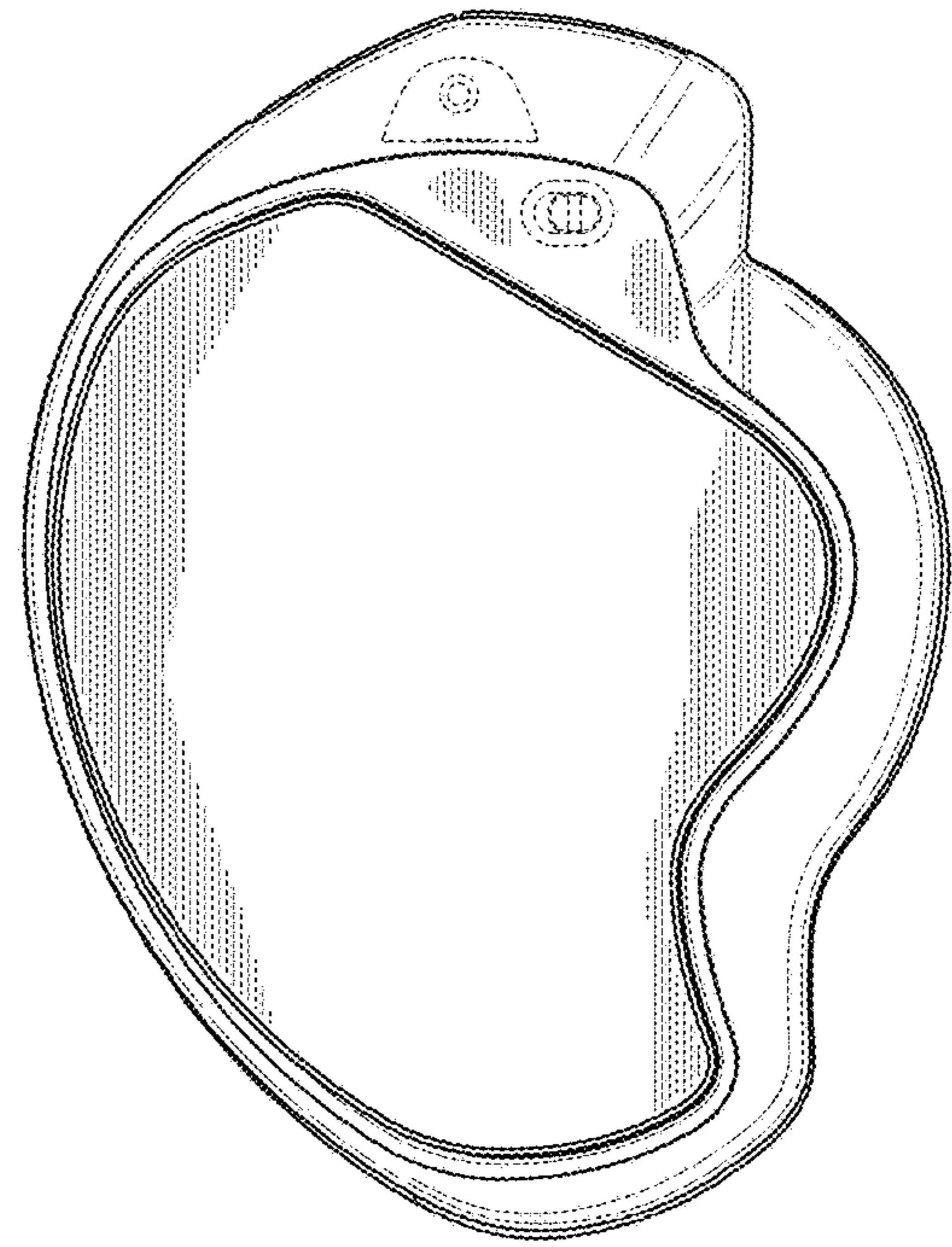

FIG. 4

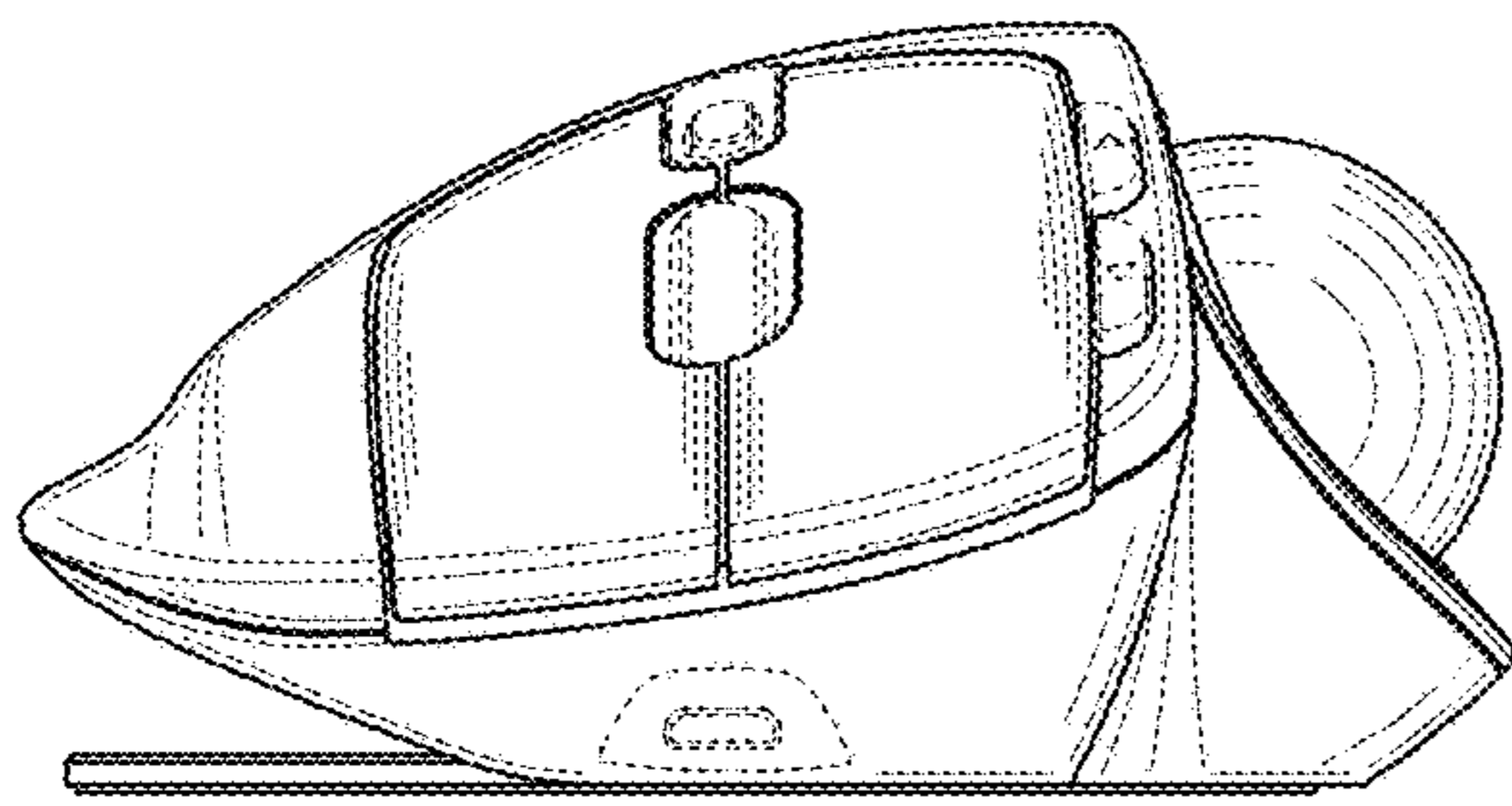

FIG. 5

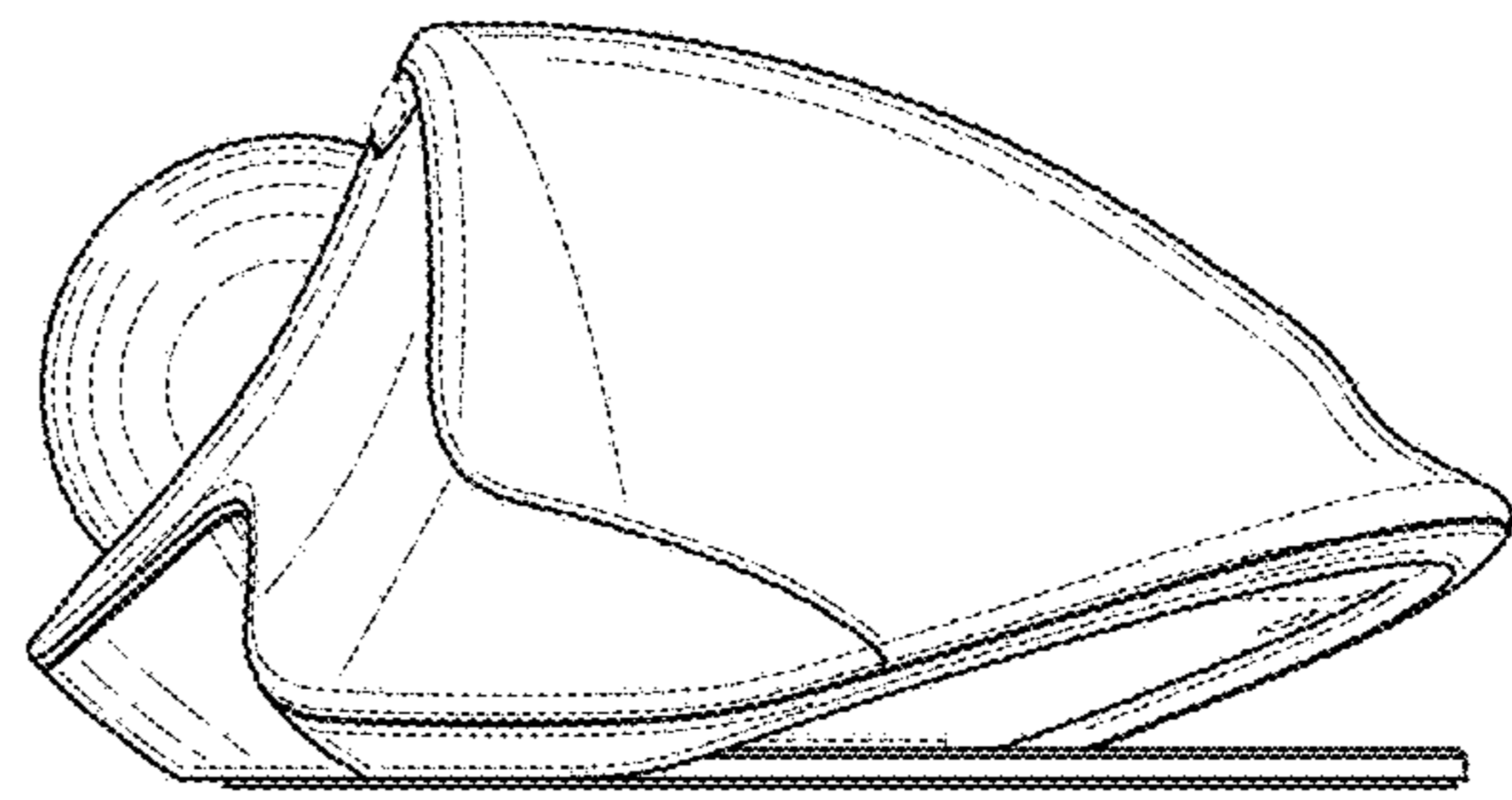

FIG. 6

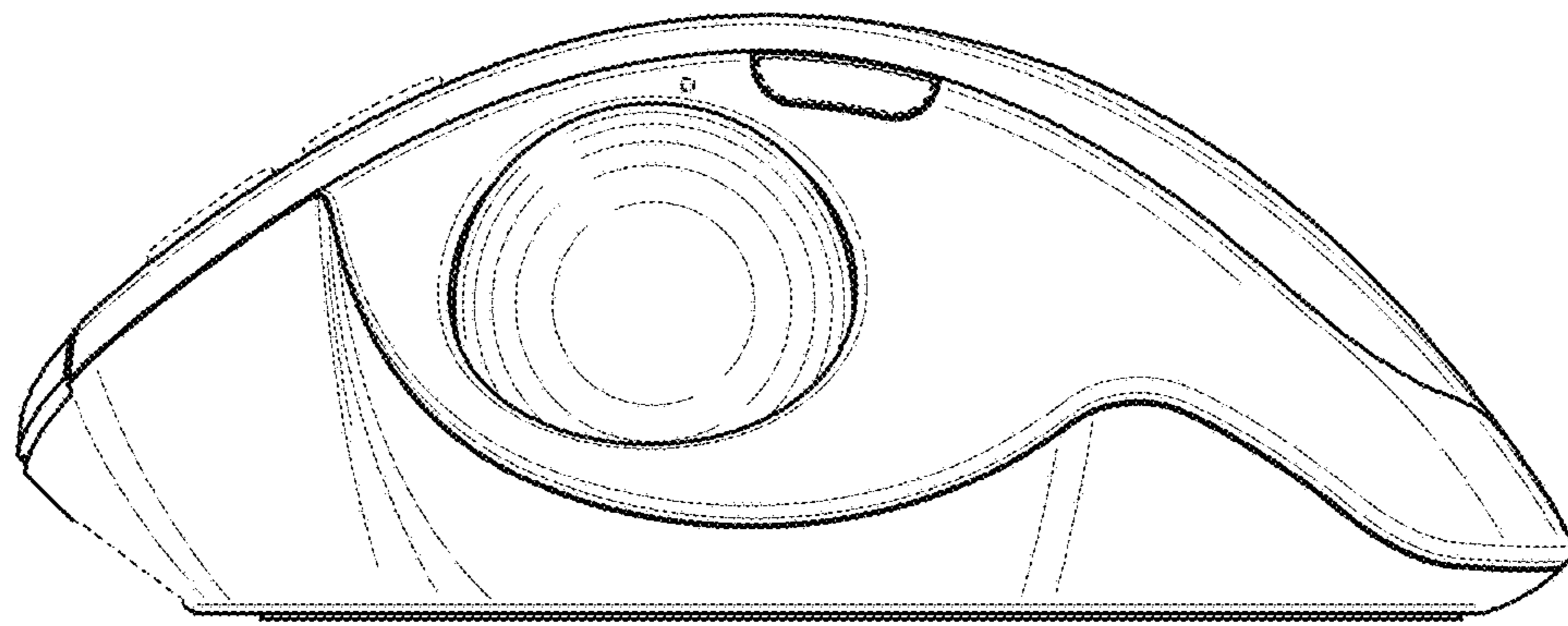

FIG. 7

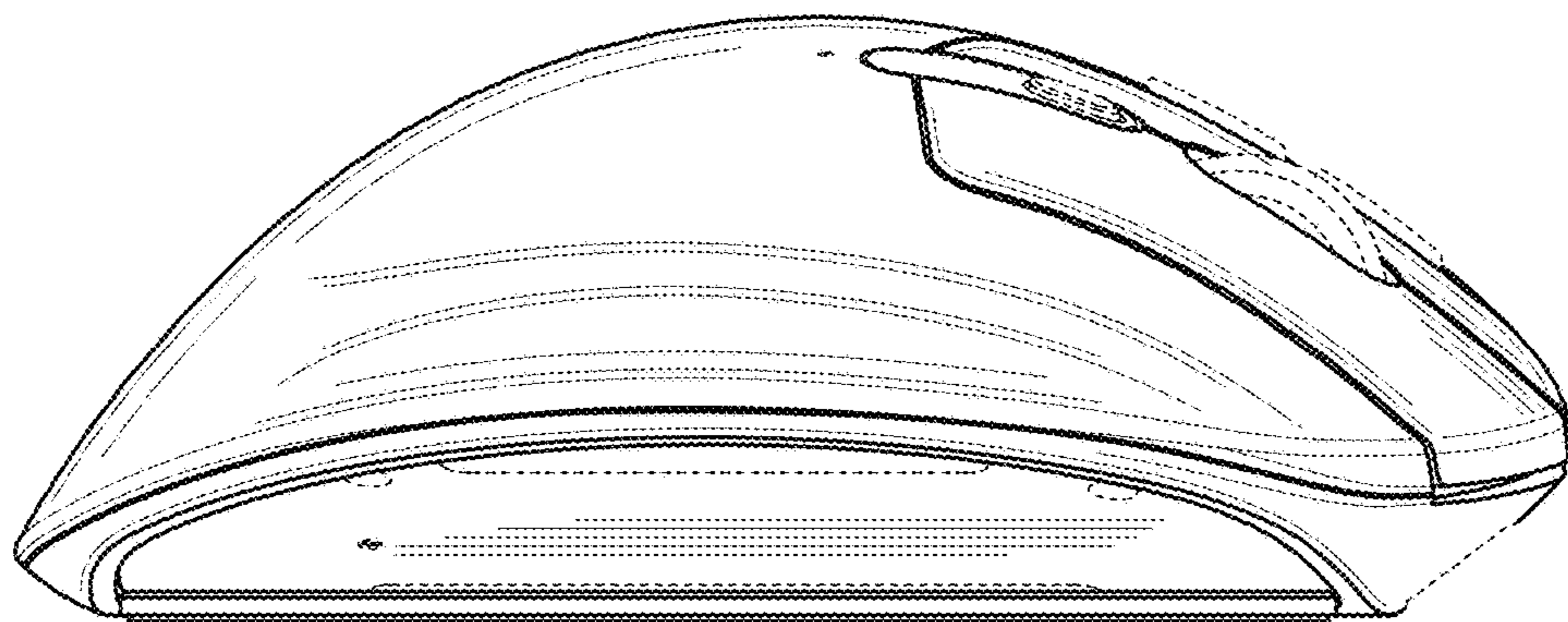

FIG. 8

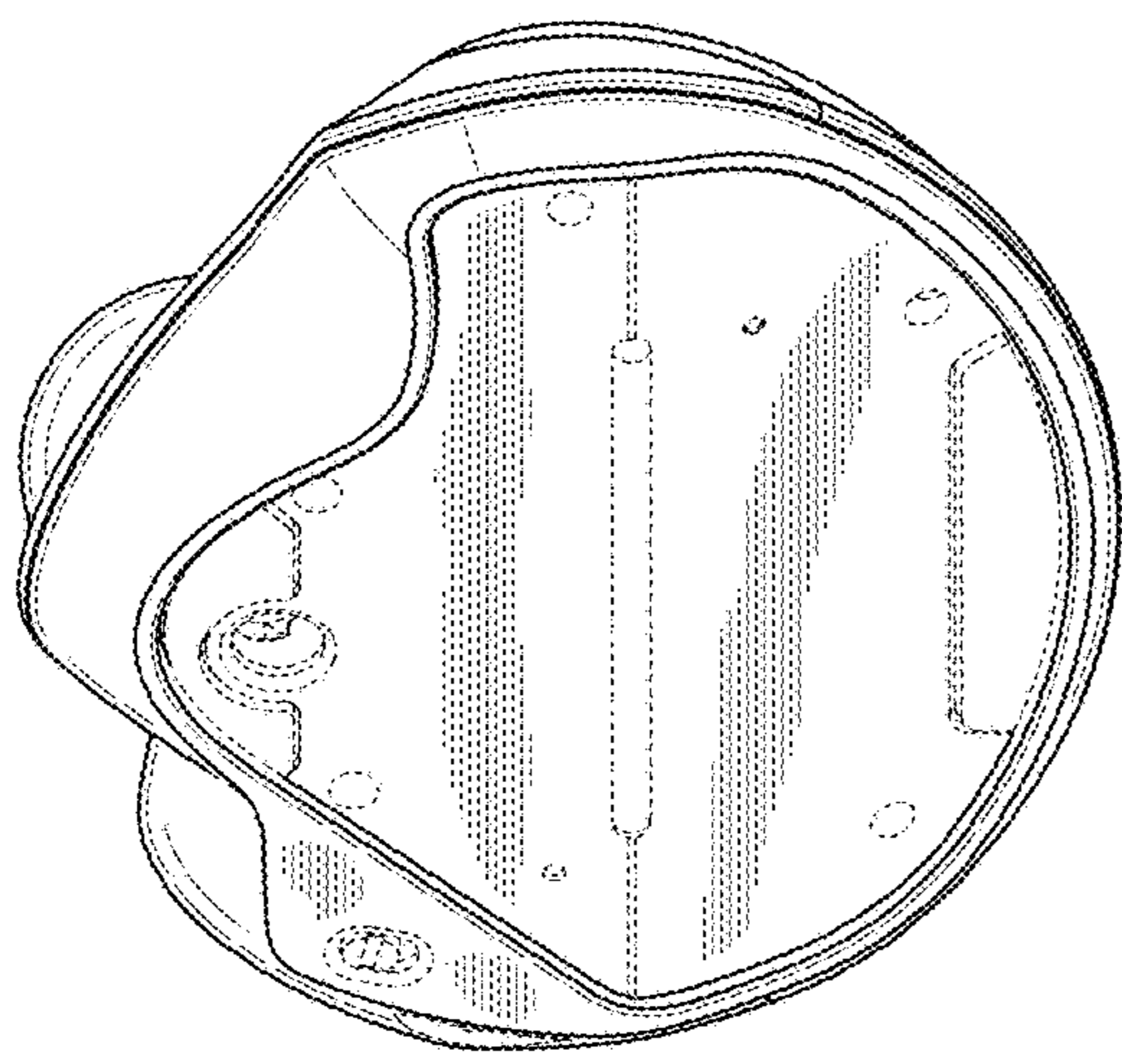

FIG. 9

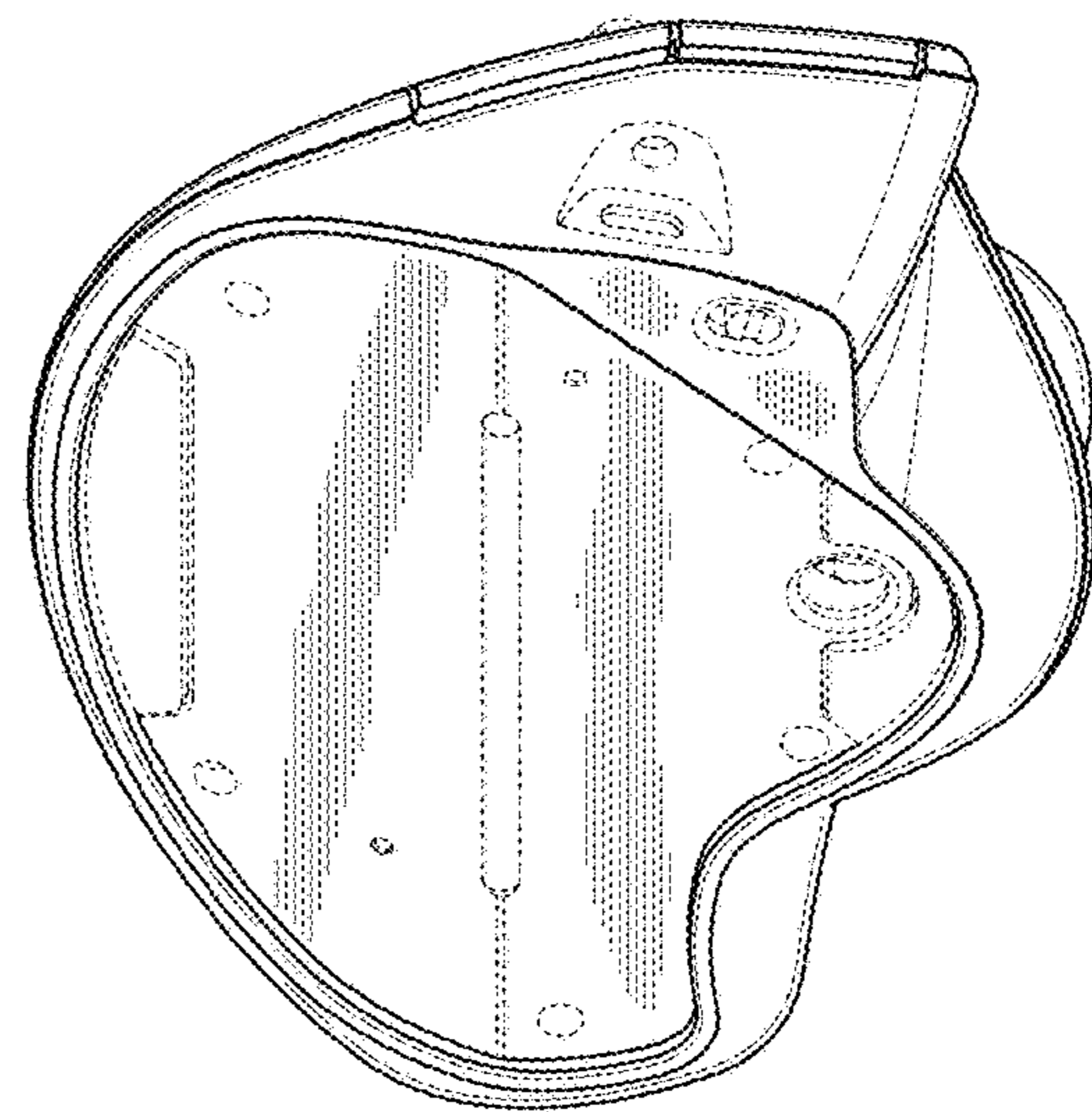

FIG. 10

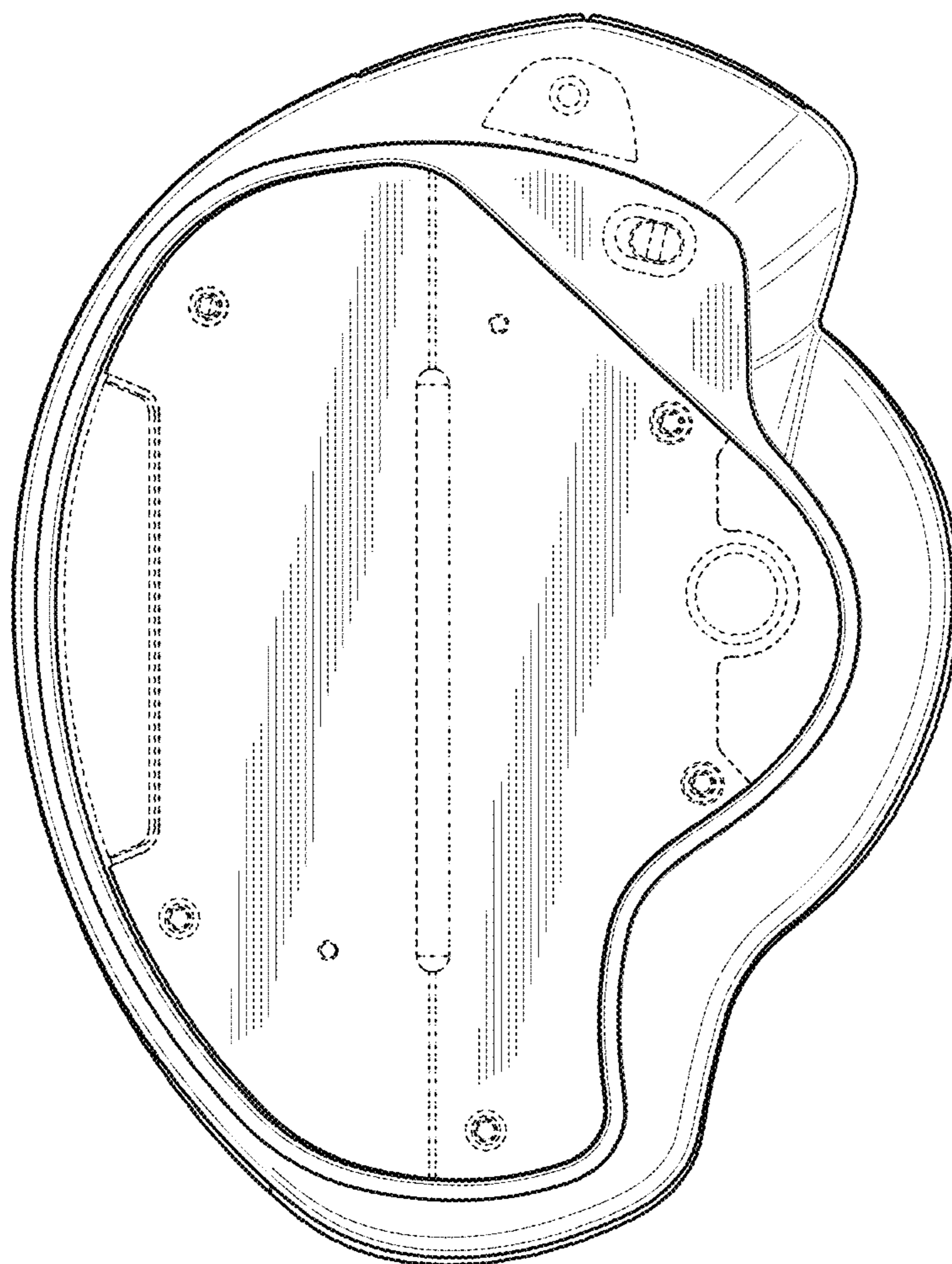

FIG. 11

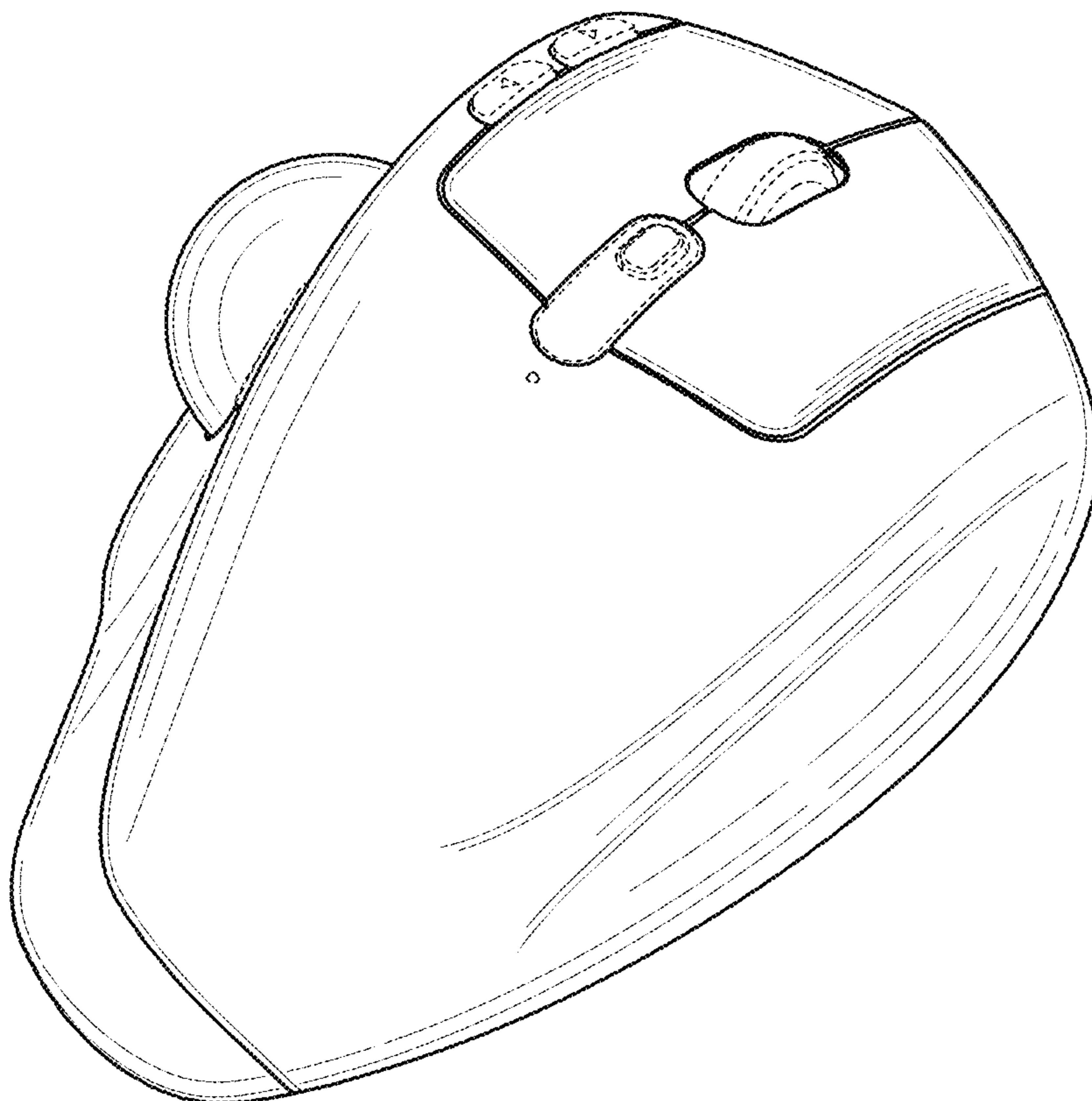

FIG. 12

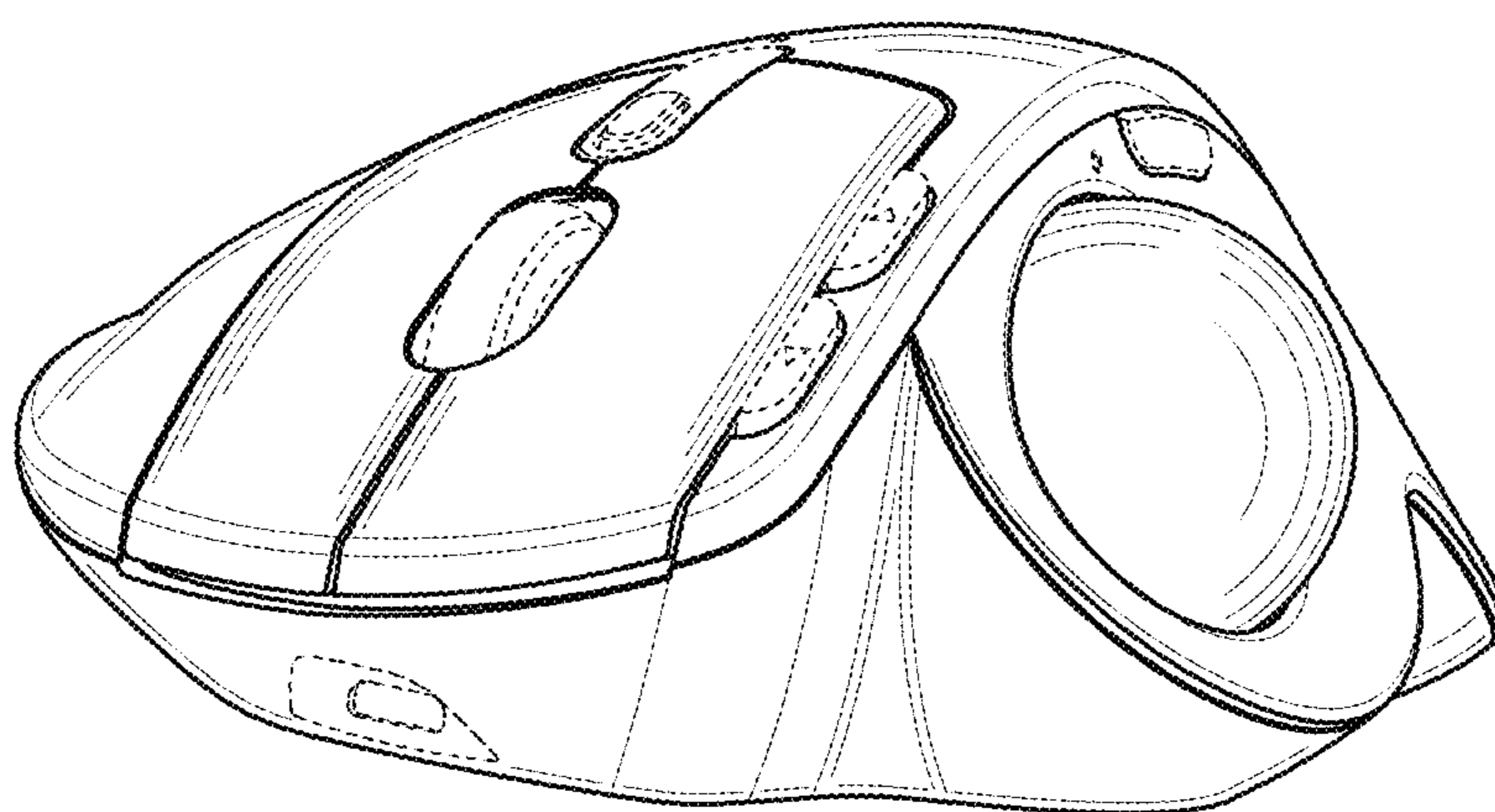

FIG. 13

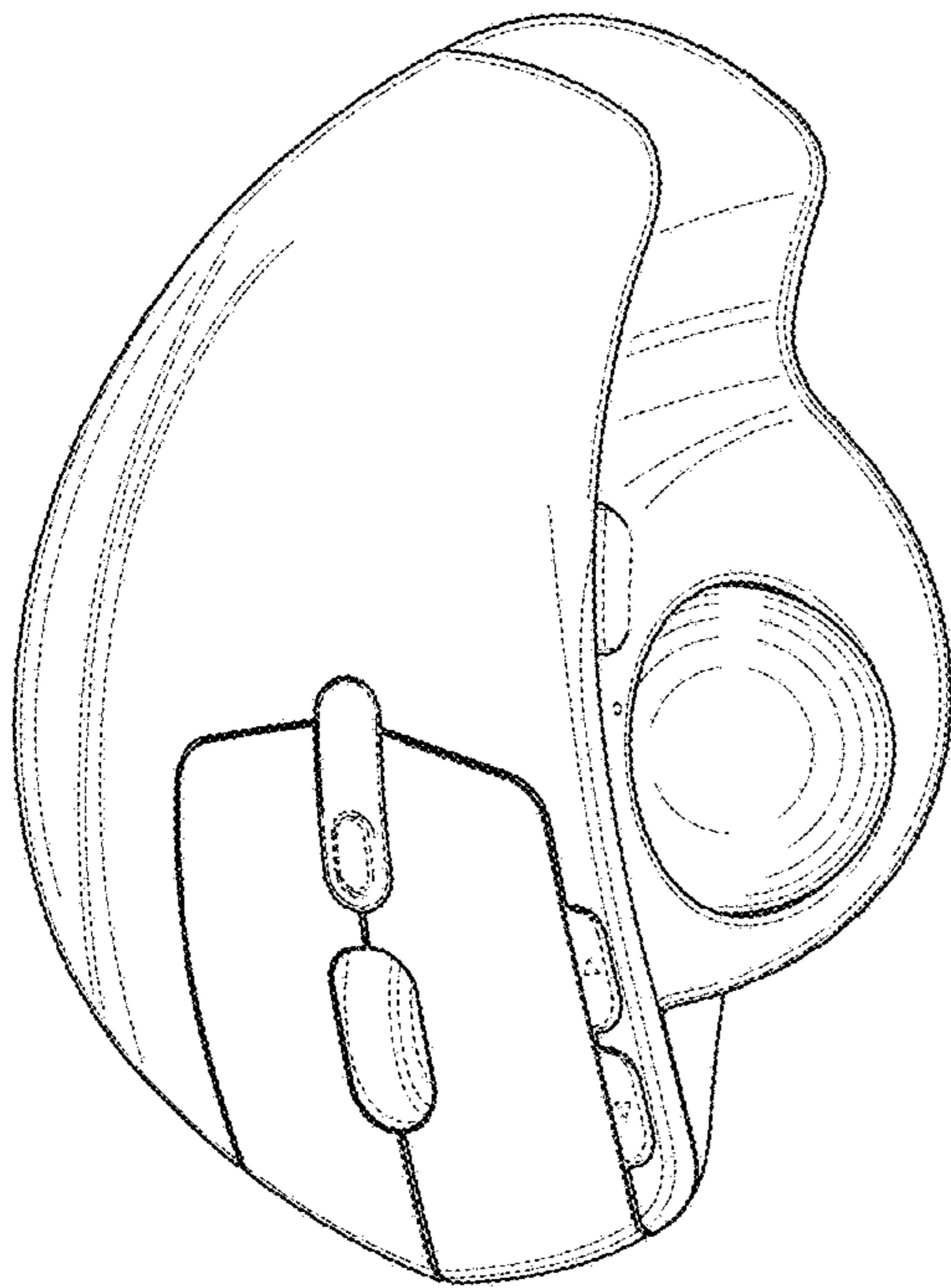

FIG. 14

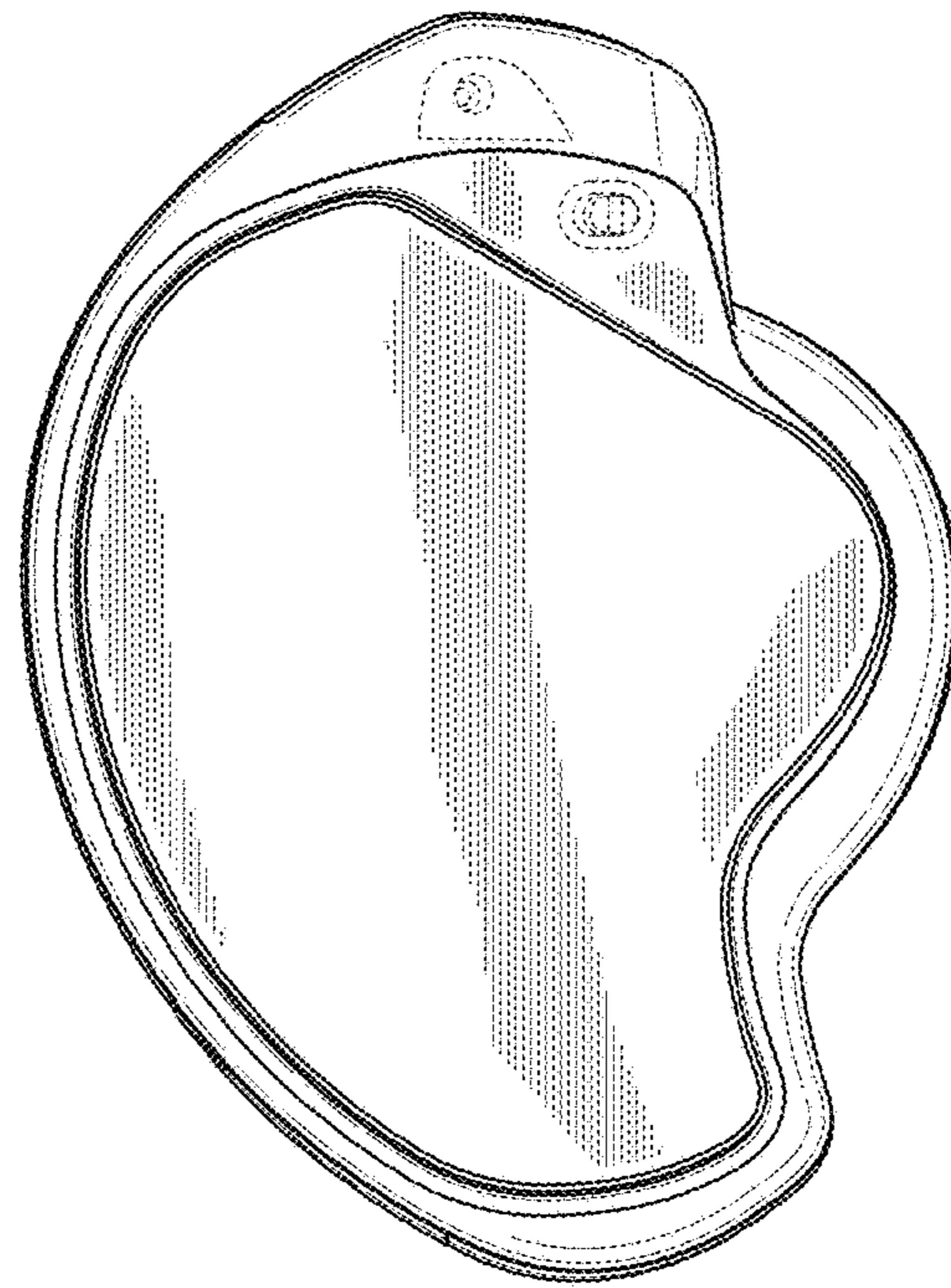

FIG. 15

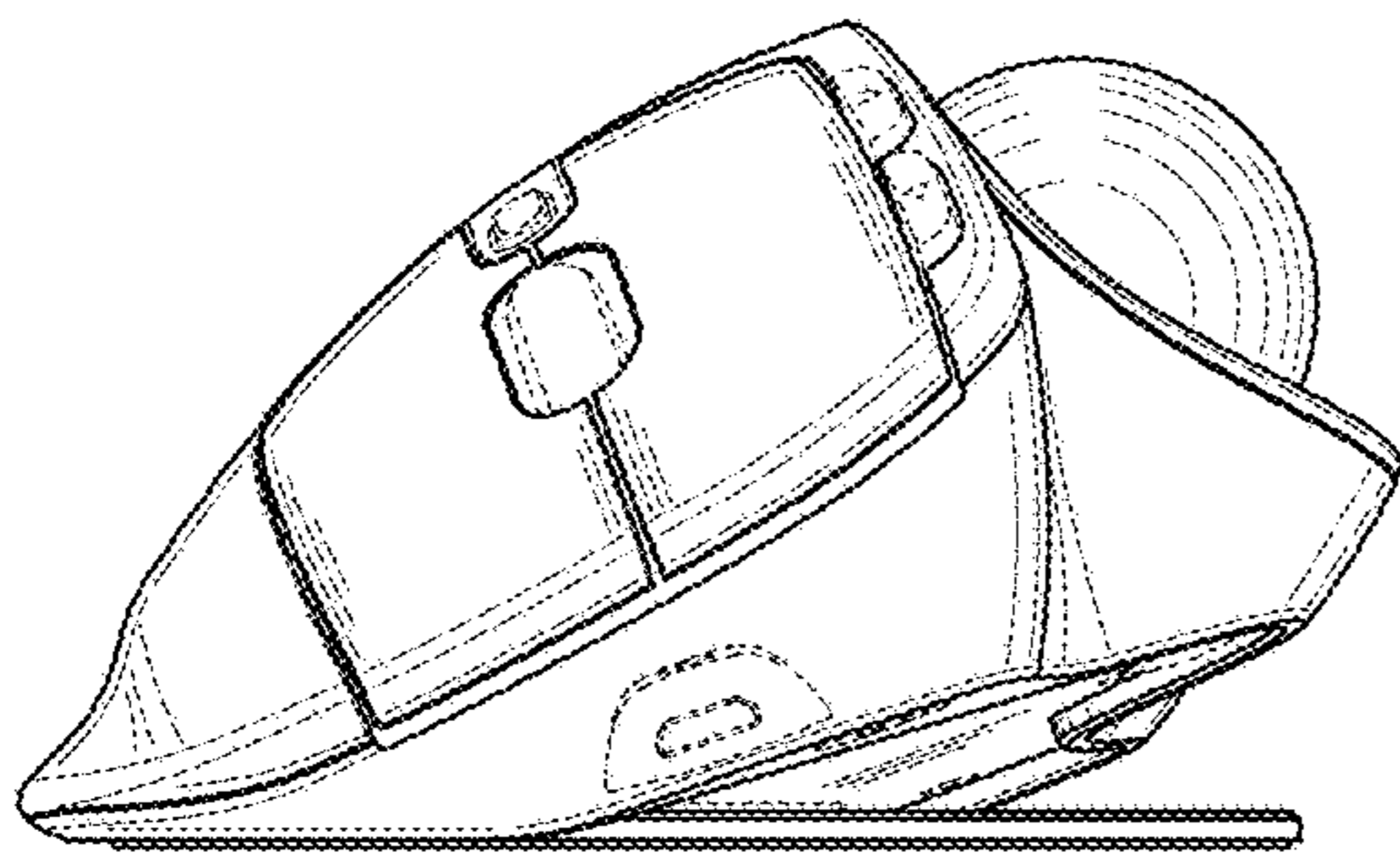

FIG. 16

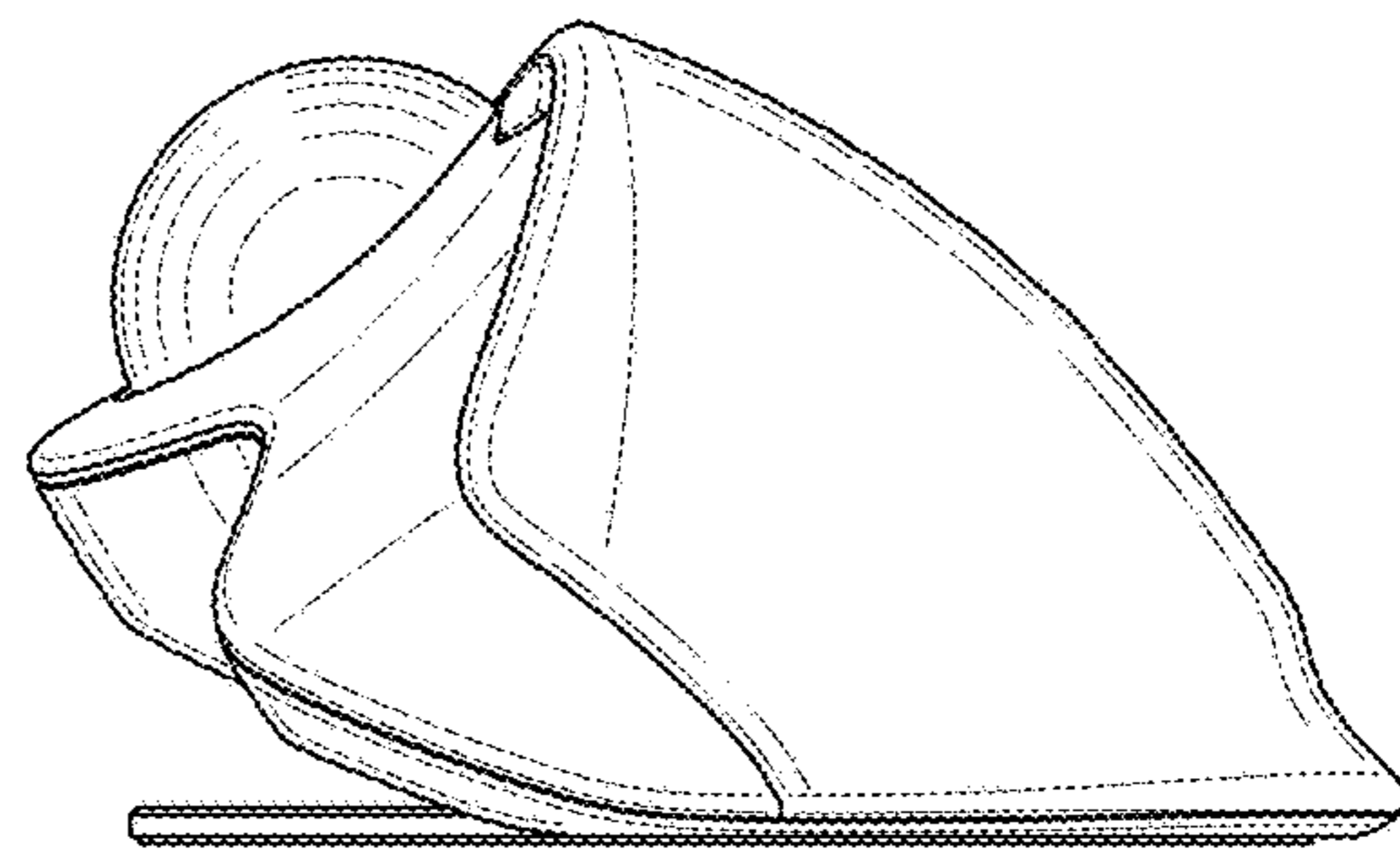

FIG. 17

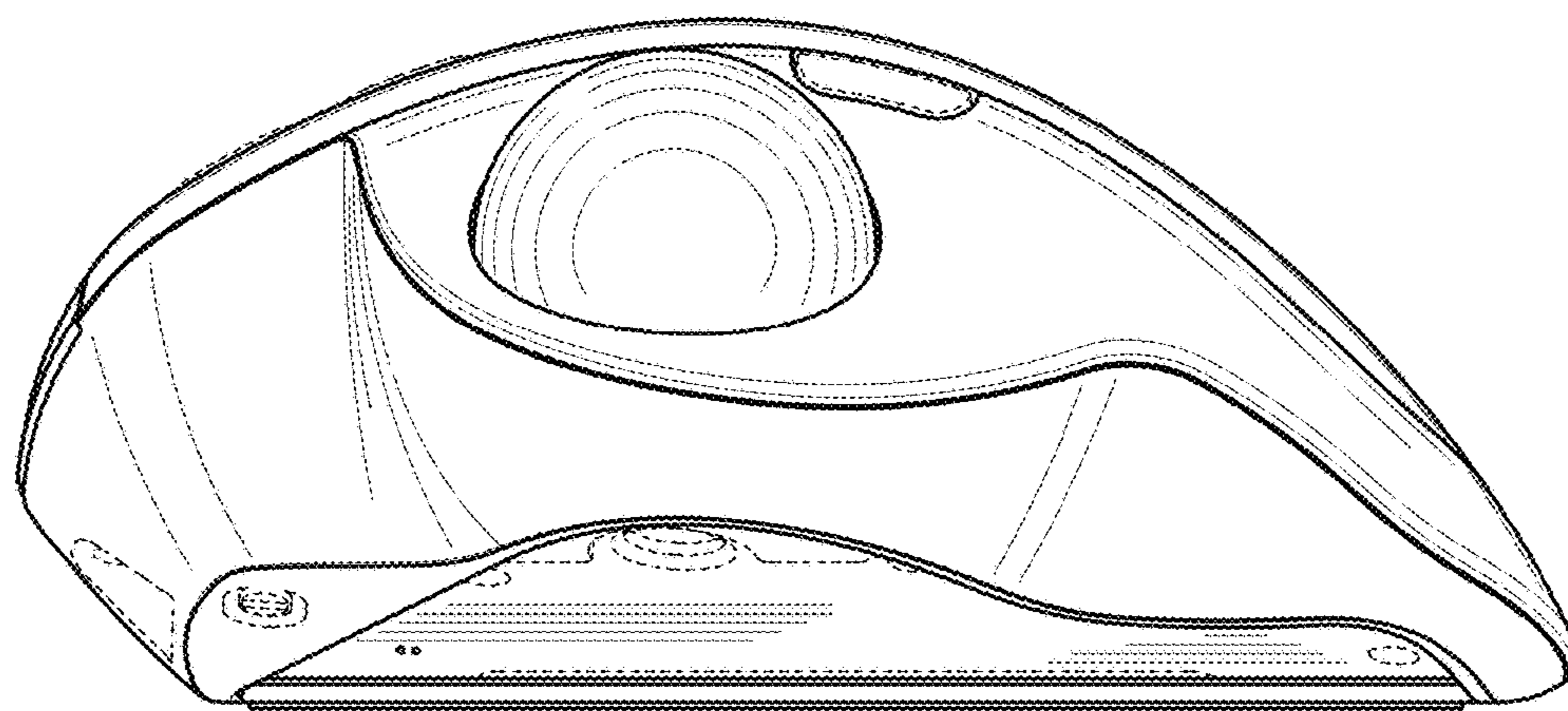

FIG. 18

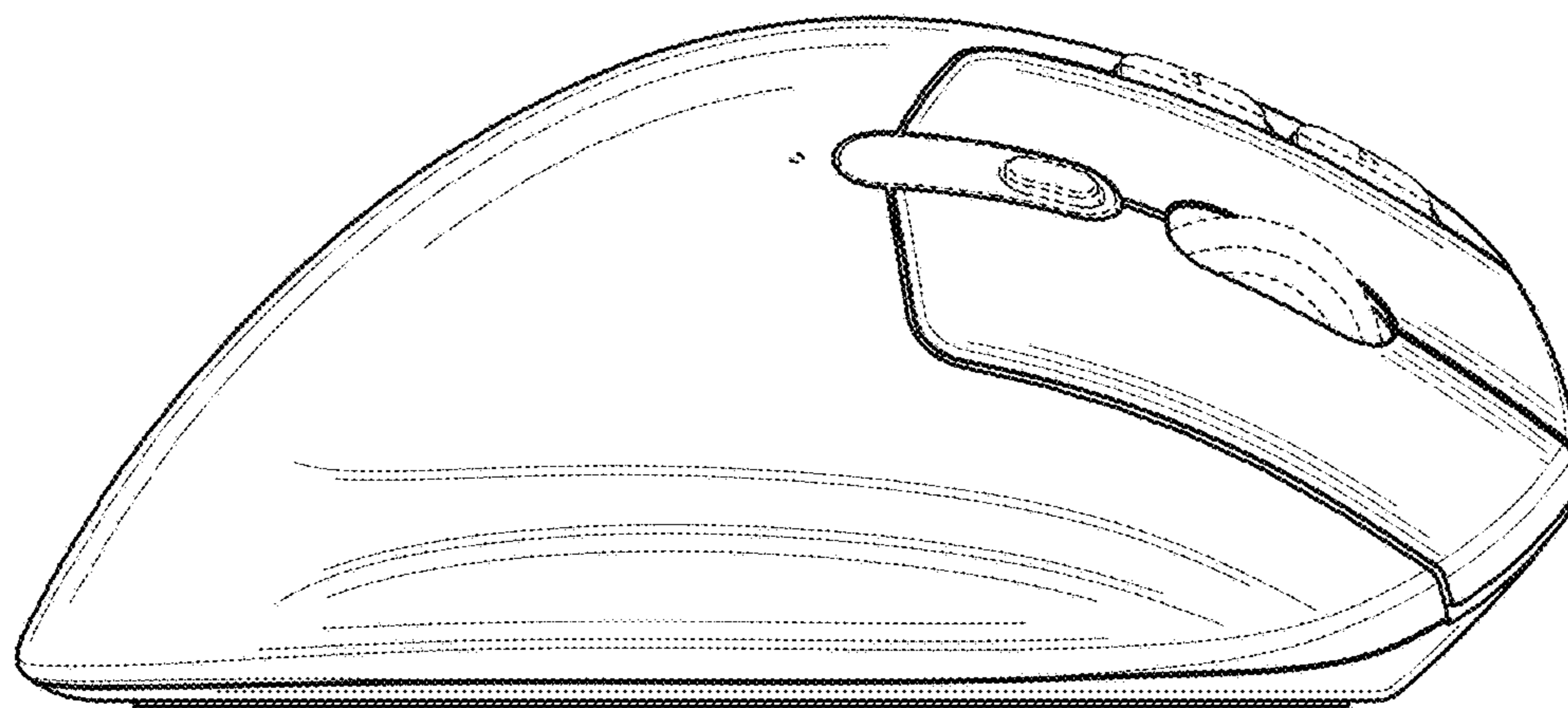

FIG. 19

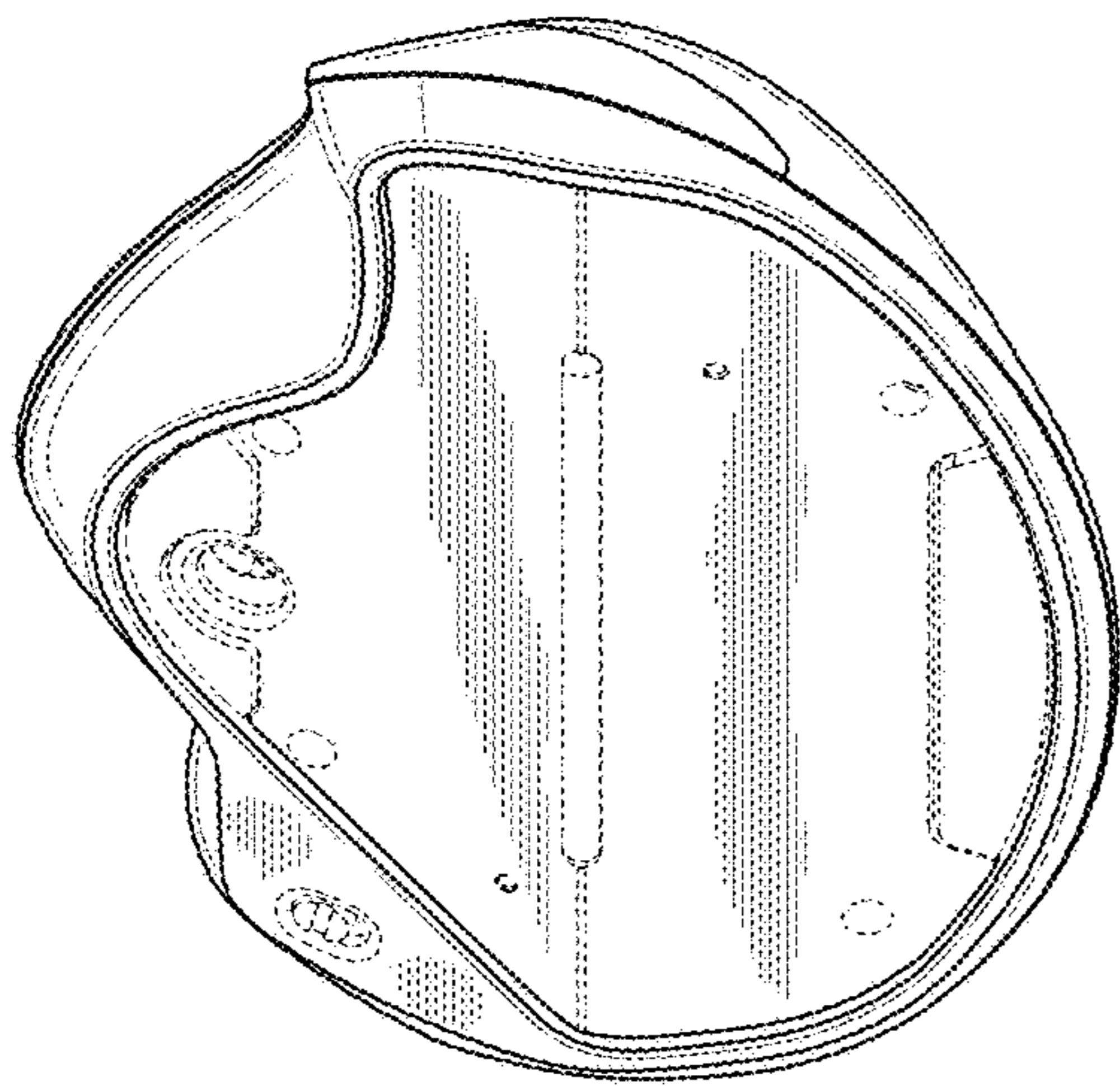

FIG. 20

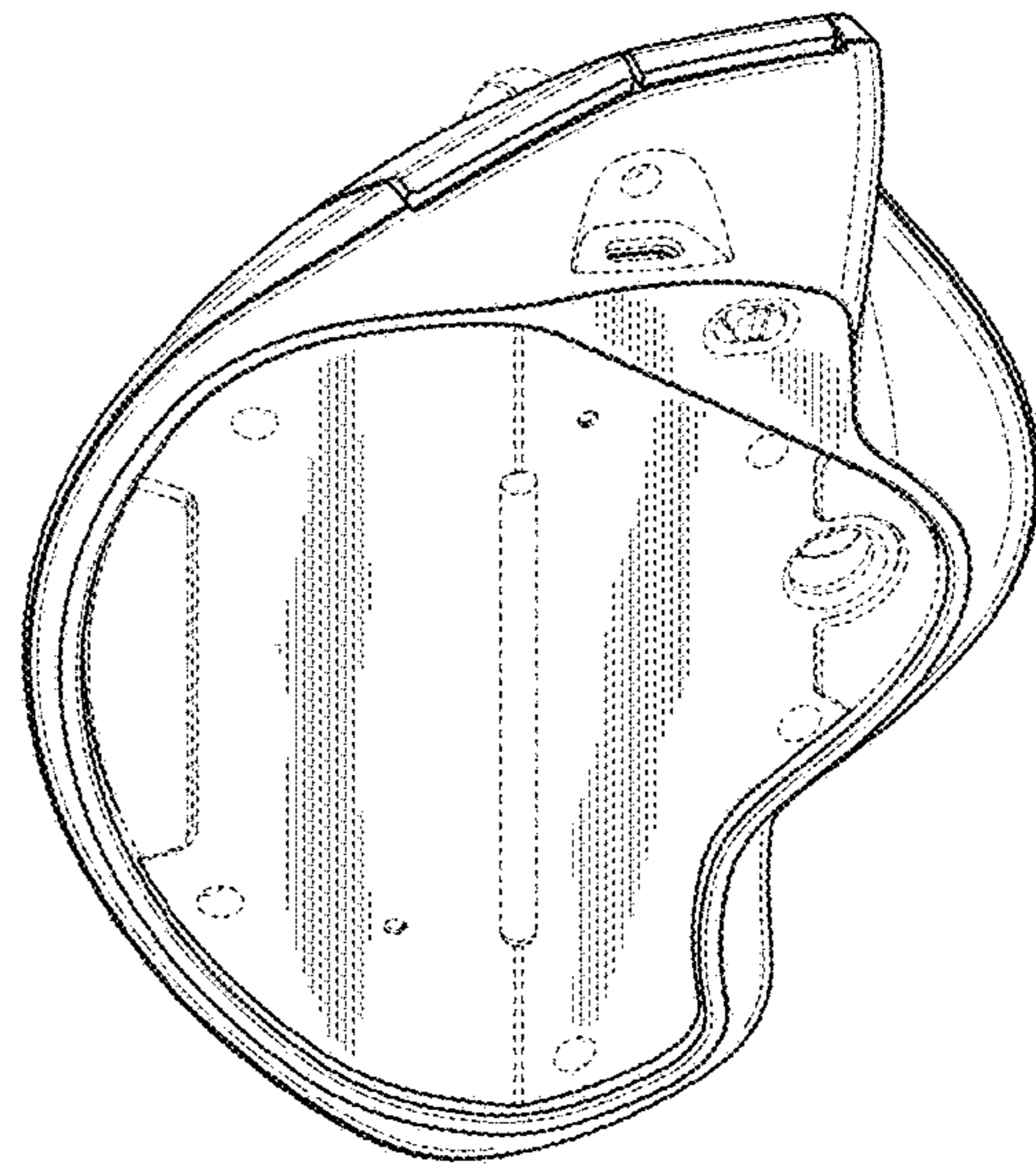

FIG. 21

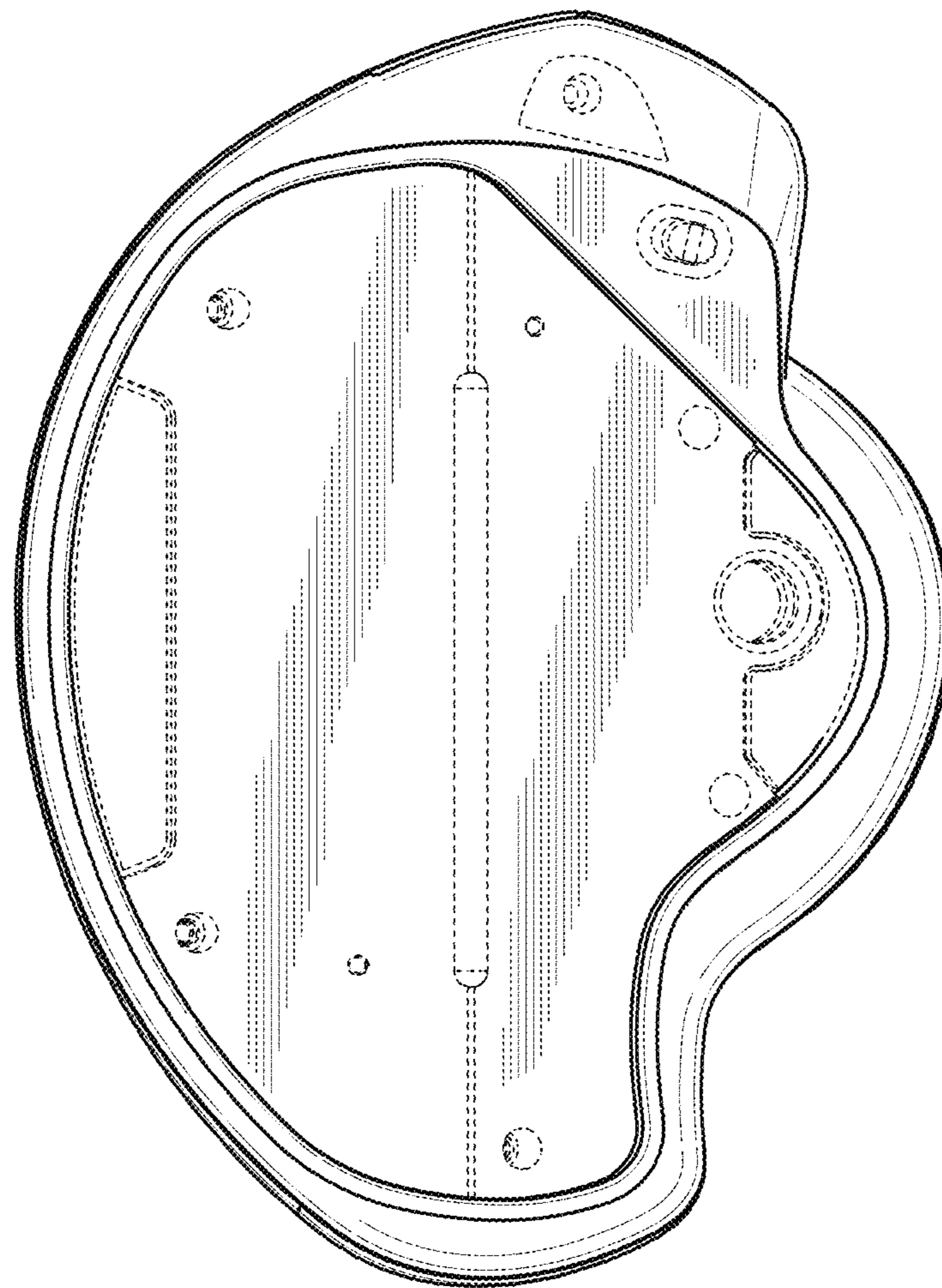

FIG. 22