



US00D834021S

(12) **United States Design Patent** (10) **Patent No.:** **US D834,021 S**  
**Park** (45) **Date of Patent:** **\*\* Nov. 20, 2018**

(54) **CONTROL DEVICE**

(71) Applicant: **Jason Park**, South San Francisco, CA (US)

(72) Inventor: **Jason Park**, South San Francisco, CA (US)

(73) Assignee: **Jason Park**, South San Francisco, CA (US)

(\*\*) Term: **15 Years**

(21) Appl. No.: **29/587,510**

(22) Filed: **Dec. 13, 2016**

(51) **LOC (11) Cl.** ..... **14-02**

(52) **U.S. Cl.**

USPC ..... **D14/401**

(58) **Field of Classification Search**

USPC ..... D14/496, 401, 435, 474, 483, 217, 137, D14/138, 160, 168, 356, 203.1-203.8, D14/507; 345/156, 169, 173-179, 905; 715/727-729, 864; 710/1, 5, 8; 713/1, 713/600; 455/1.1, 1.7, 73, 344-347, 93, 455/95, 3.01-3.06, 550.1, 573.1; 370/342-344; 369/1, 2, 6-12; 463/43-47; 273/148 B; D21/424-433  
CPC ..... H04N 5/00; H04B 10/00; H04J 14/00; G10H 7/00; G11B 7/00

See application file for complete search history.

(56) **References Cited**

**U.S. PATENT DOCUMENTS**

5,207,426 A \* 5/1993 Inoue ..... A63F 13/06 345/184  
5,259,626 A \* 11/1993 Ho ..... A63F 13/06 273/148 B

(Continued)

**FOREIGN PATENT DOCUMENTS**

WO 2015148693 A1 10/2015

*Primary Examiner* — Keli L Hill

(74) *Attorney, Agent, or Firm* — Procopio, Cory, Hargreaves & Savitch LLP

(57) **CLAIM**

The ornamental design for a control device, as shown and described.

**DESCRIPTION**

FIG. 1 is a top perspective view of a control device showing my new design;

FIG. 2 is a top plan view thereof;

FIG. 3 is a bottom plan view thereof;

FIG. 4 is a front side elevational view thereof;

FIG. 5 is a rear side elevational view thereof;

FIG. 6 is a right elevational view thereof;

FIG. 7 is left elevational view thereof;

FIG. 8 is a bottom perspective view thereof;

FIG. 9 is a top perspective view of a second embodiment of a control device;

FIG. 10 is a top plan view of FIG. 9;

FIG. 11 is a bottom plan view of FIG. 9;

FIG. 12 is a front side elevational view of FIG. 9;

FIG. 13 is a rear side elevational view of FIG. 9;

FIG. 14 is a right elevational view of FIG. 9;

FIG. 15 is left elevational view of FIG. 9;

FIG. 16 is a bottom perspective view of FIG. 9;

FIG. 17 is a top perspective view of a third embodiment of a control device;

FIG. 18 is a top plan view of FIG. 17;

FIG. 19 is a bottom plan view of FIG. 17;

FIG. 20 is a front side elevational view of FIG. 17;

FIG. 21 is a rear side elevational view of FIG. 17;

FIG. 22 is a right elevational view of FIG. 17;

FIG. 23 is left elevational view of FIG. 17;

FIG. 24 is a bottom perspective view of FIG. 17;

FIG. 25 is a top perspective view of the fourth embodiment of a control device;

FIG. 26 is a top plan view thereof of FIG. 25;

FIG. 27 is a bottom plain view thereof FIG. 25;

FIG. 28 is a left side elevational view thereof of FIG. 25;

FIG. 29 is a right side elevational view thereof of FIG. 25;

(Continued)

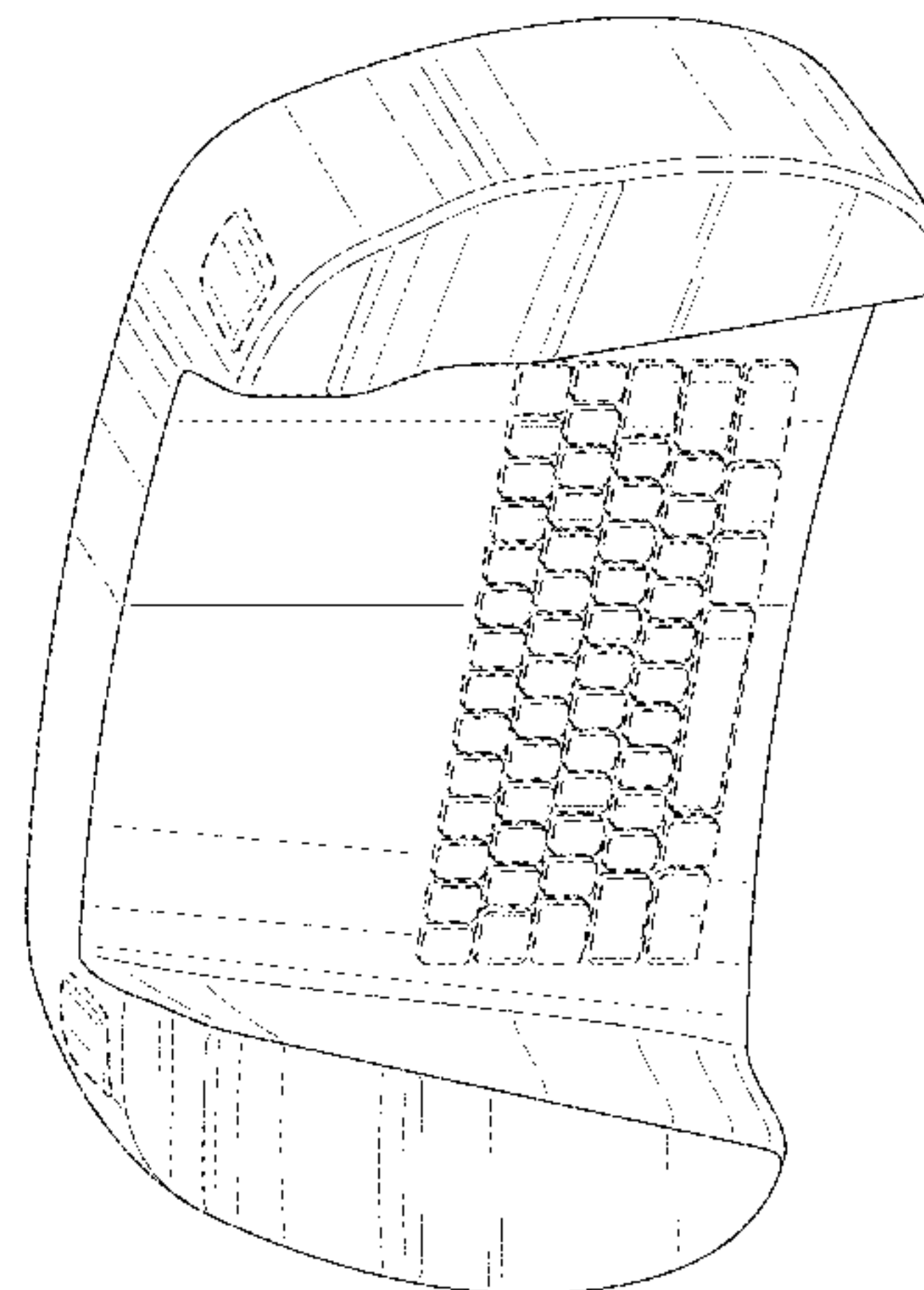
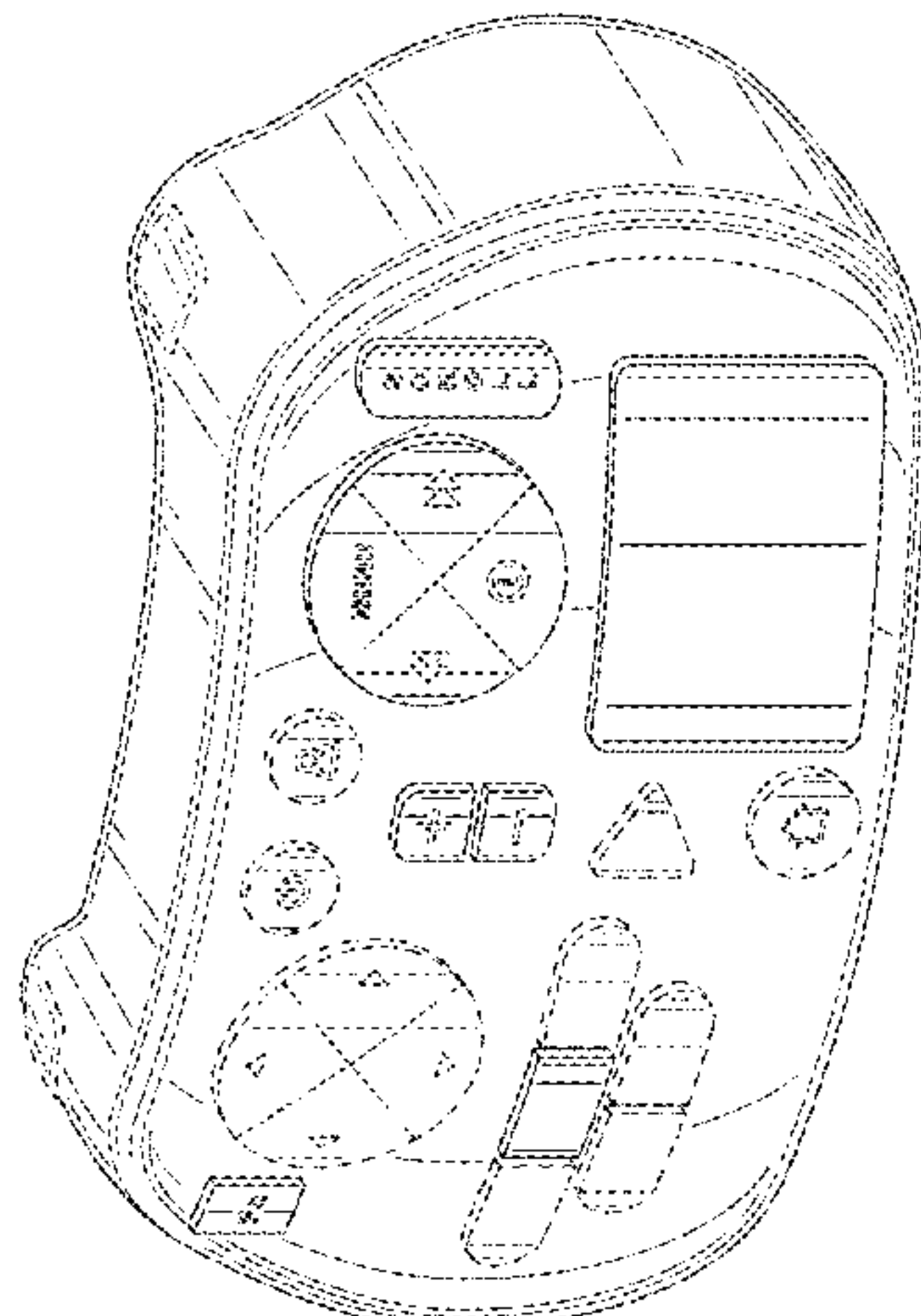

FIG. 30 is a front side elevational view of FIG. 25;  
 FIG. 31 is a rear side elevational view of FIG. 25;  
 FIG. 32 bottom plain view thereof FIG. 25;  
 FIG. 33 is a top perspective view of the fifth embodiment of a control device;  
 FIG. 34 is a top plan view thereof of FIG. 33;  
 FIG. 35 is a bottom plain view thereof FIG. 33;  
 FIG. 36 is a left side elevational view thereof of FIG. 33;  
 FIG. 37 is a right side elevational view thereof of FIG. 33;  
 FIG. 38 is a front side elevational view of FIG. 33;  
 FIG. 39 is a rear side elevational view of FIG. 33;  
 FIG. 40 is a bottom plain view thereof FIG. 33;  
 FIG. 41 is a top perspective view of the sixth embodiment of a control device;  
 FIG. 42 is a top plan view thereof of FIG. 41;  
 FIG. 43 is a bottom plain view thereof FIG. 41;  
 FIG. 44 is a left side elevational view thereof of FIG. 41;  
 FIG. 45 is a right side elevational view thereof of FIG. 41;  
 FIG. 46 is a front side elevational view of FIG. 41;  
 FIG. 47 is a rear side elevational view of FIG. 41;  
 FIG. 48 is a bottom plain view thereof FIG. 41;  
 FIG. 49 is a top perspective view of the seventh embodiment of a control device;  
 FIG. 50 is a top plan view thereof of FIG. 49;  
 FIG. 51 is a bottom plain view thereof FIG. 49;  
 FIG. 52 is a left side elevational view thereof of FIG. 49;  
 FIG. 53 is a right side elevational view thereof of FIG. 49;  
 FIG. 54 is a front side elevational view of FIG. 49;

FIG. 55 is a rear side elevational view of FIG. 49; and,  
 FIG. 56 is a bottom plain view thereof FIG. 49.  
 The broken lines indicate unclaimed portions and form no part of the claimed design.

**1 Claim, 49 Drawing Sheets**

(56)

**References Cited**

U.S. PATENT DOCUMENTS

5,643,087	A *	7/1997	Marcus	.....	A63F 13/06 273/148 B
5,769,719	A *	6/1998	Hsu	.....	G06F 3/0238 273/148 B
6,042,478	A *	3/2000	Ng	.....	A63F 13/02 273/148 B
D568,883	S *	5/2008	Ashida	.....	D14/400
D568,884	S *	5/2008	Kawanobe	.....	D14/401
7,499,284	B2 *	3/2009	Kawanobe	.....	A63F 13/08 361/752
7,859,514	B1	12/2010	Park		
D697,140	S *	1/2014	Baum	.....	D14/401
D702,771	S *	4/2014	Mar	.....	D14/401
D715,362	S *	10/2014	He	.....	D14/401
9,369,768	B1	6/2016	Mandel et al.		
D783,722	S *	4/2017	Peng	.....	D14/400
D794,076	S *	8/2017	Goltche	.....	D14/496

\* cited by examiner



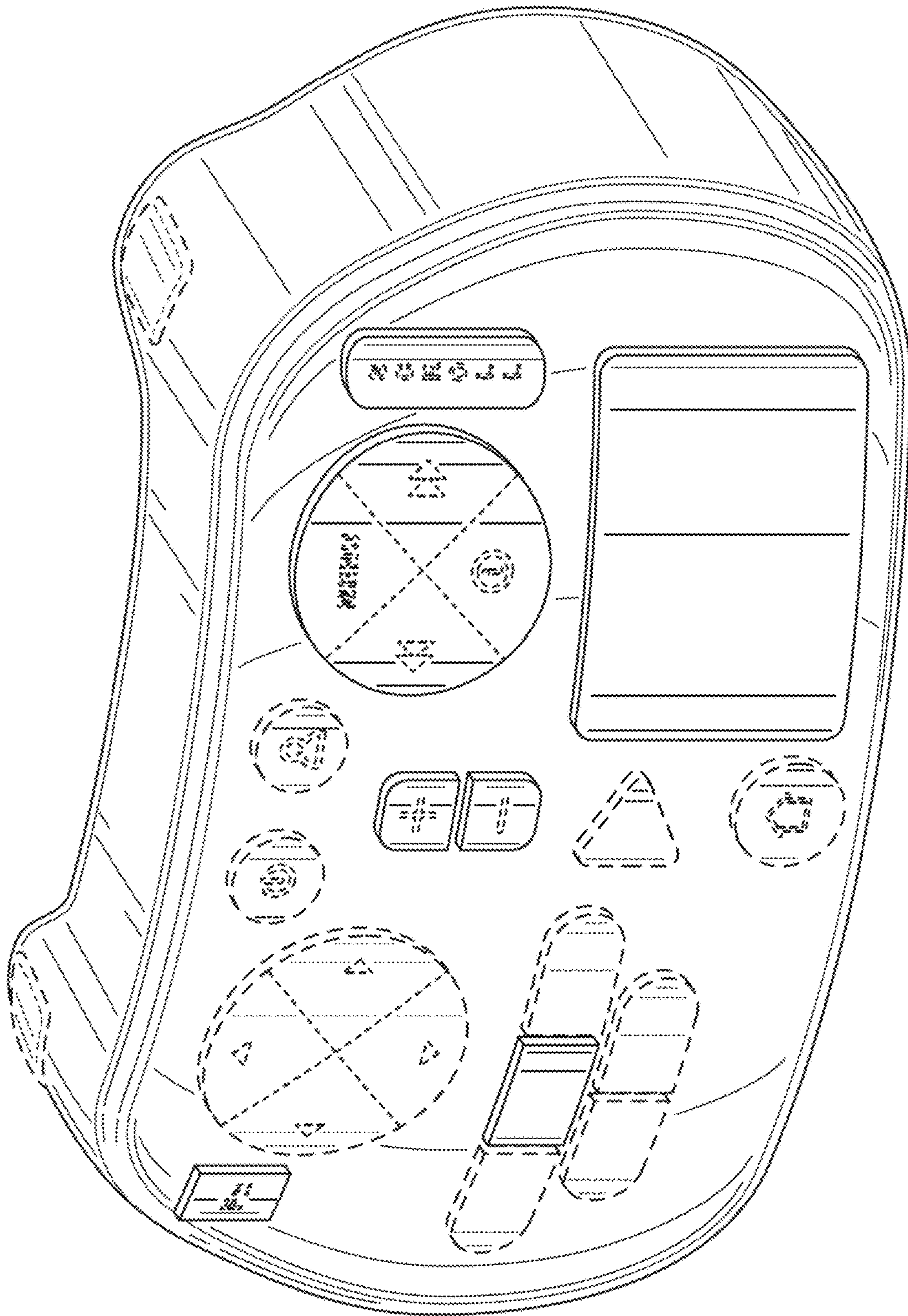

FIG. 1

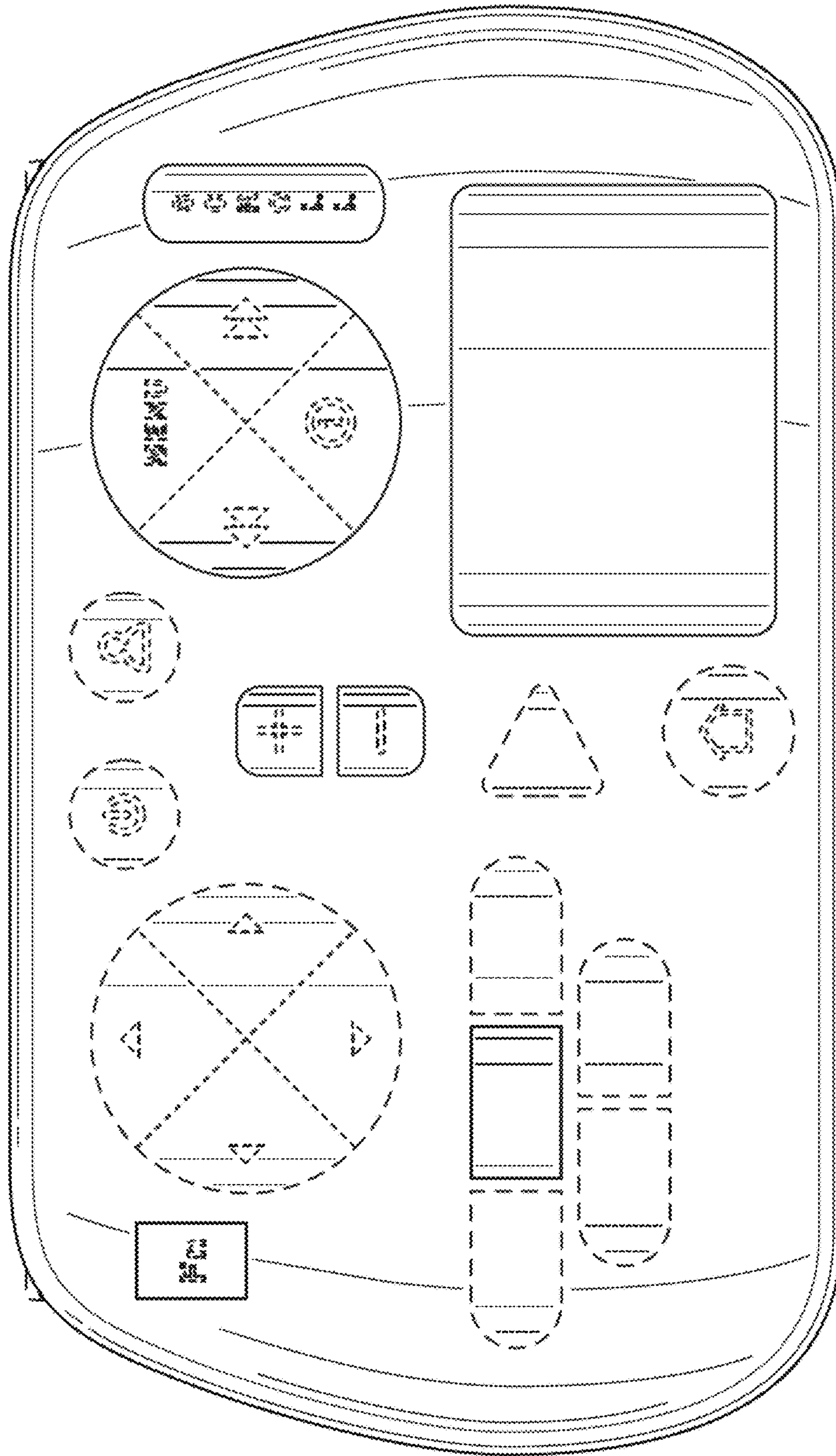

FIG. 2

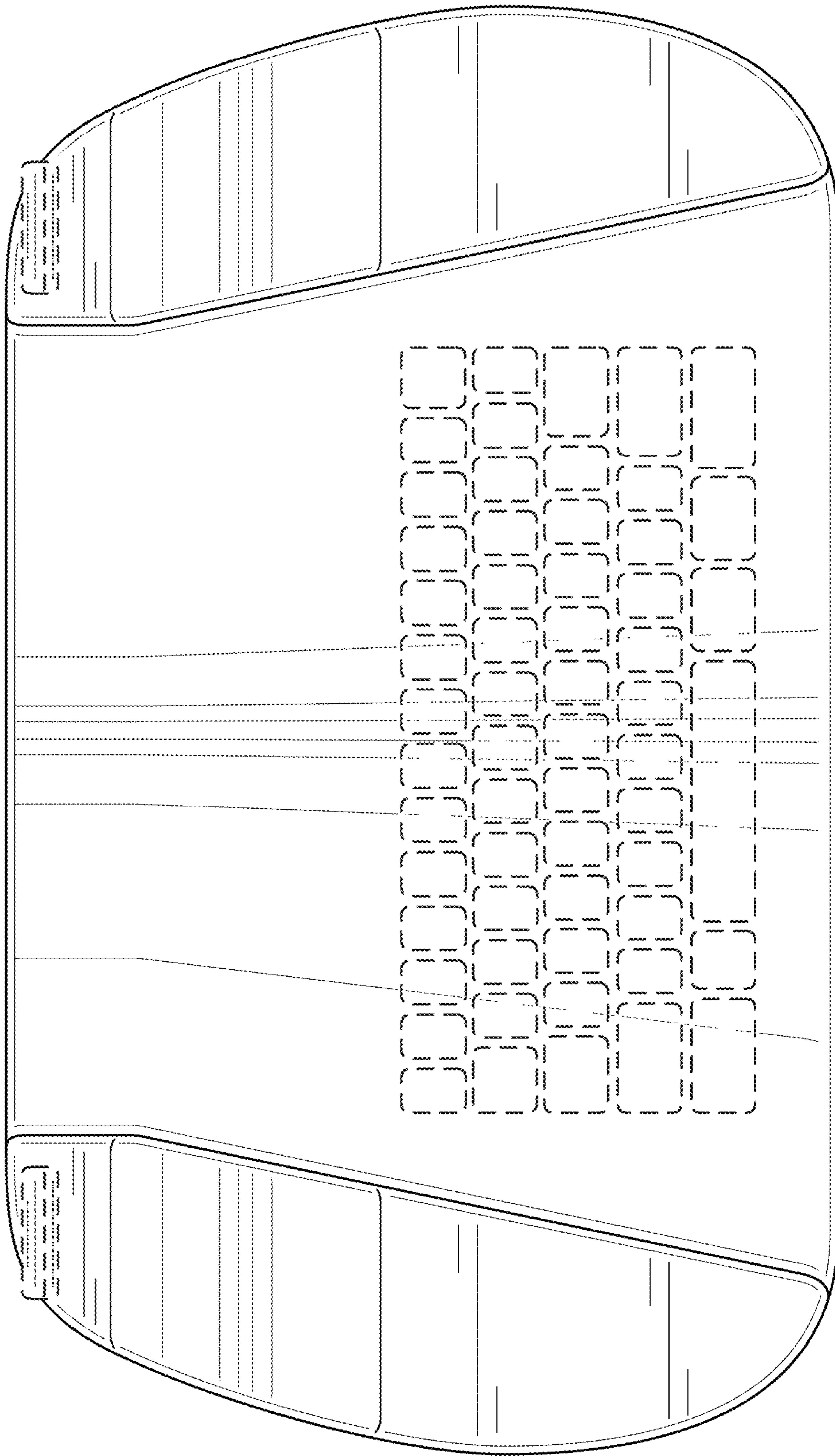

FIG. 3



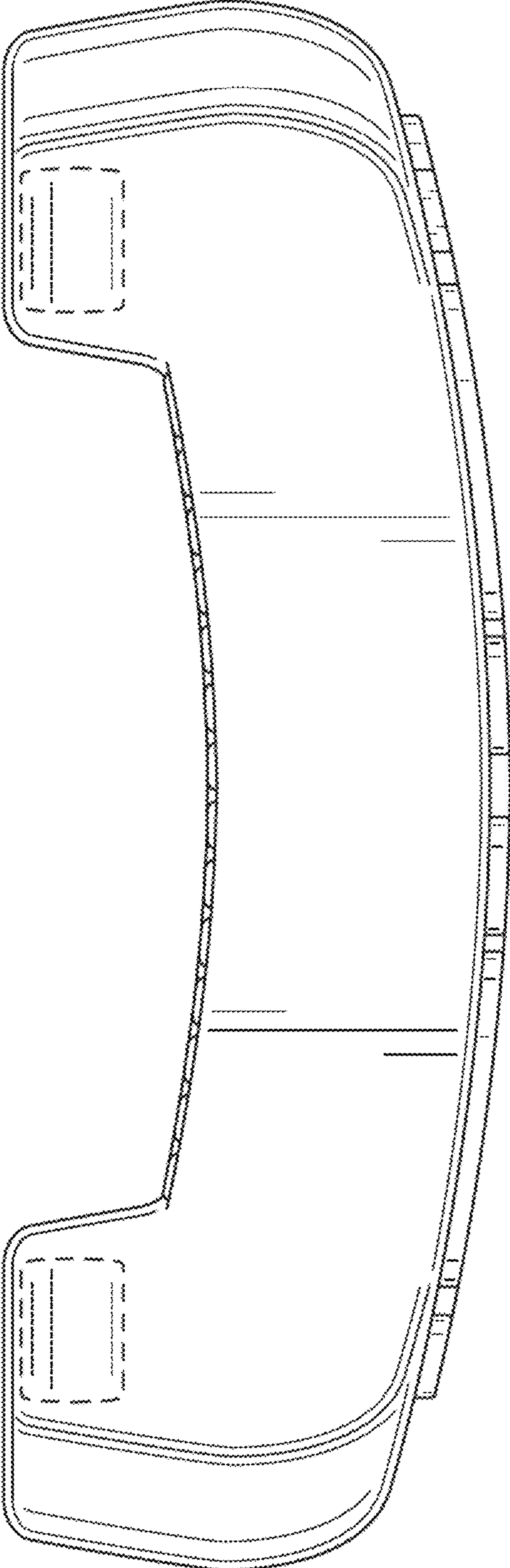

FIG. 4

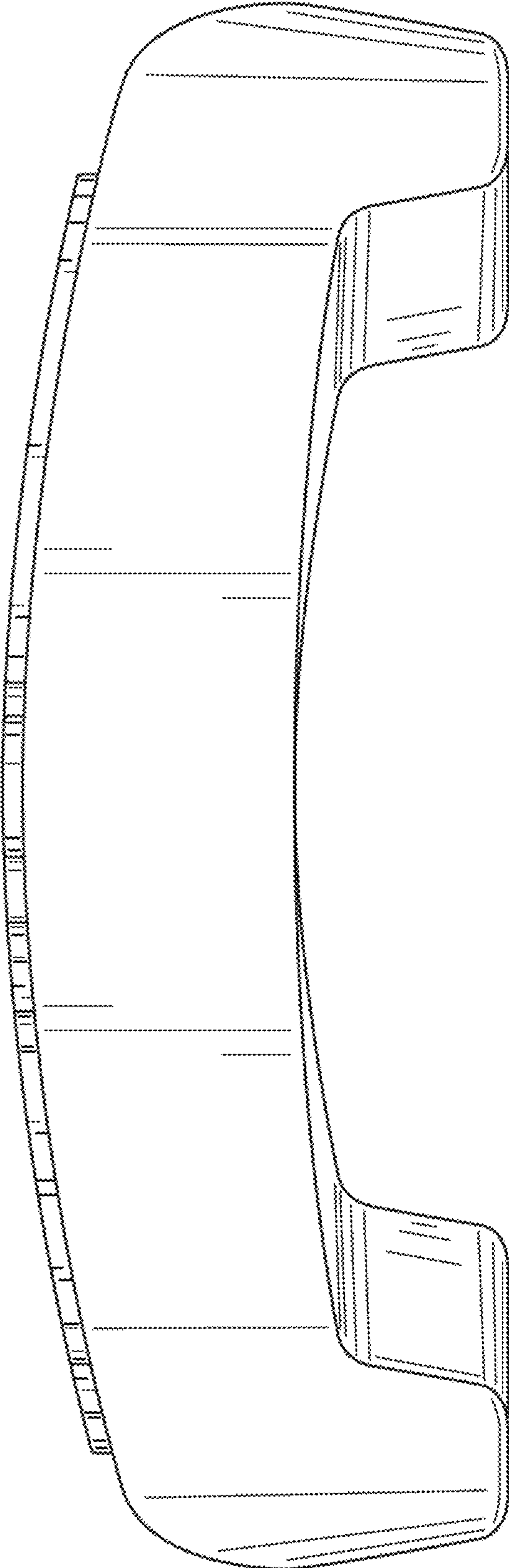

FIG. 5

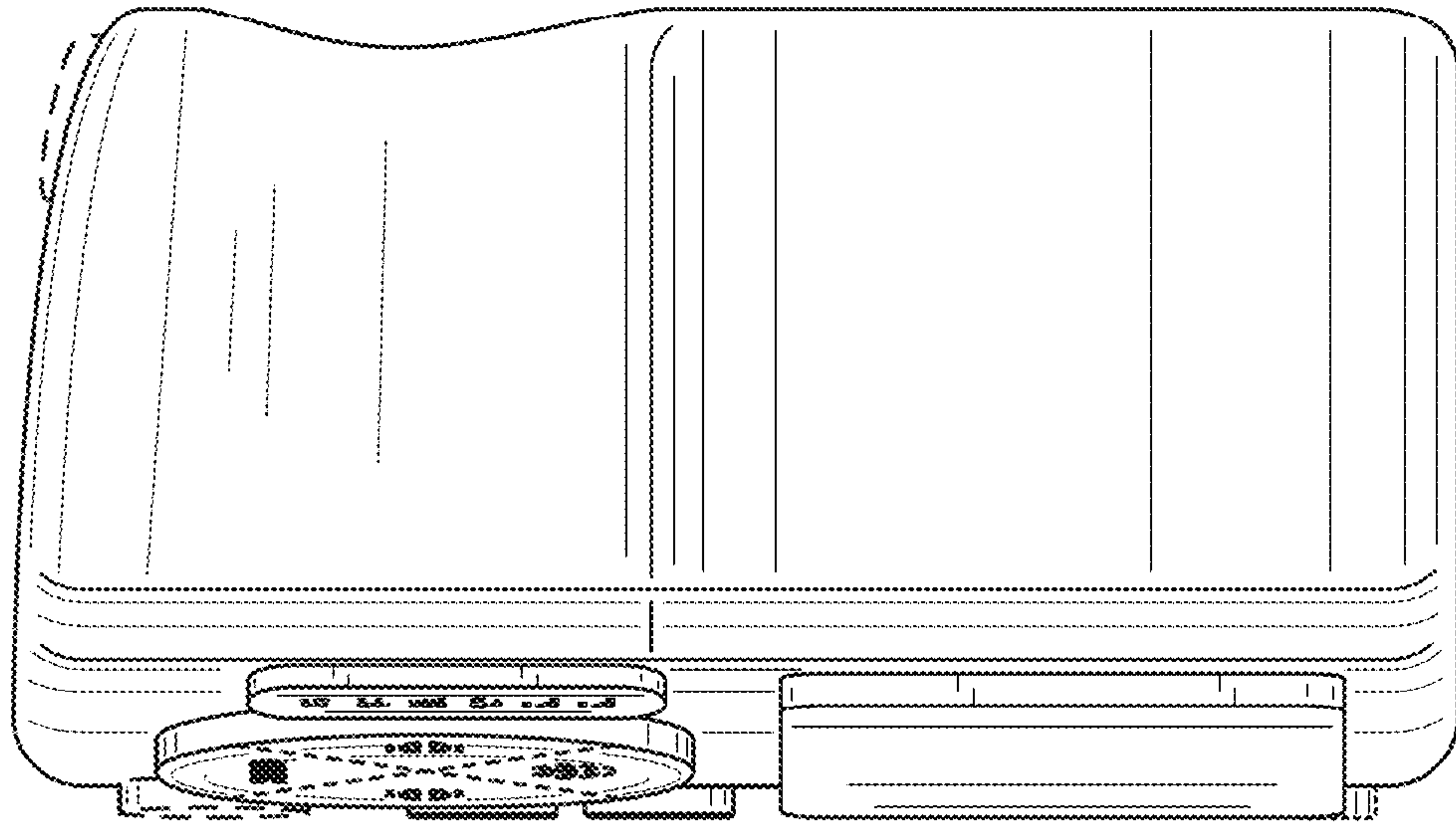

FIG. 6

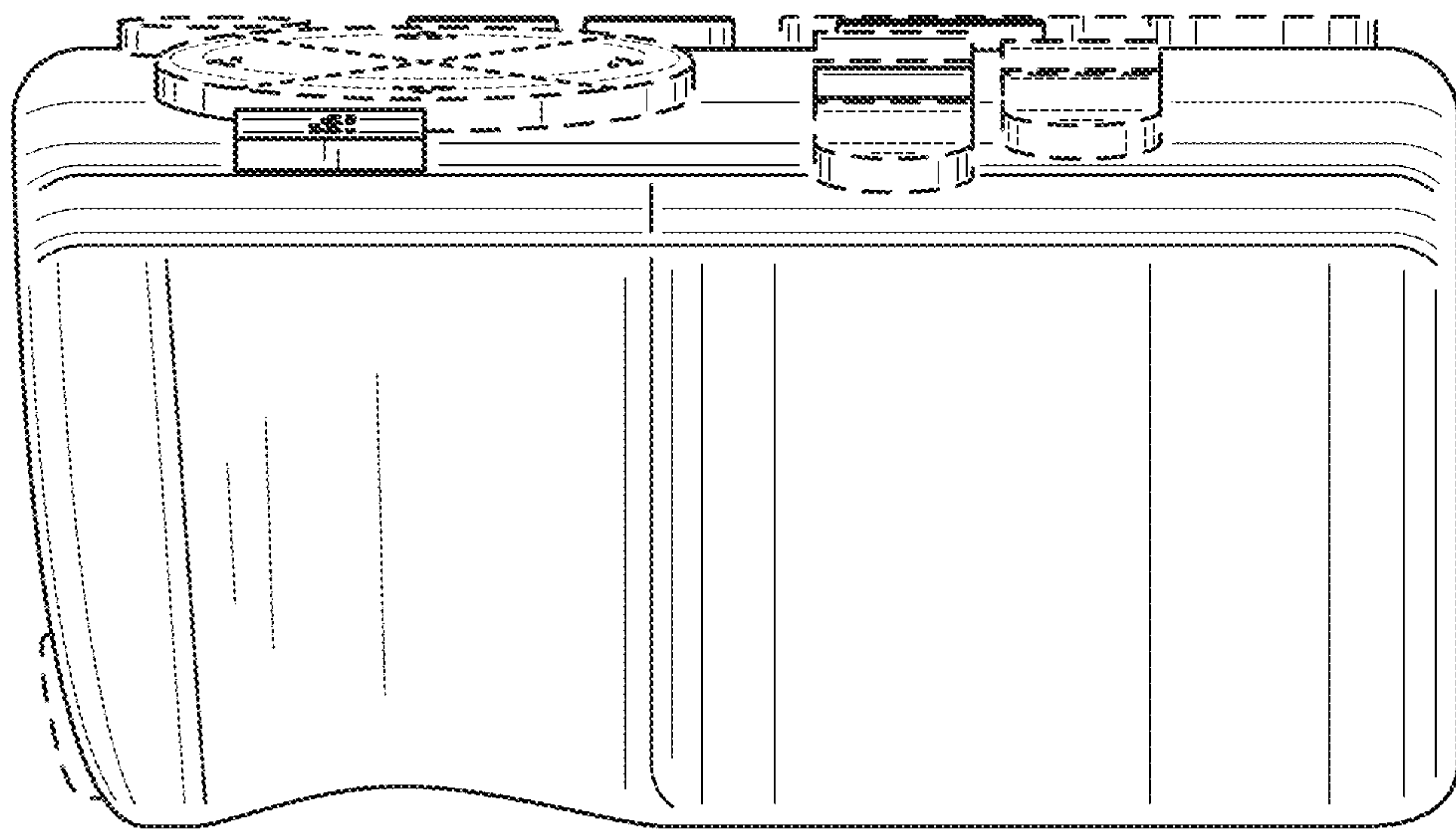

FIG. 7



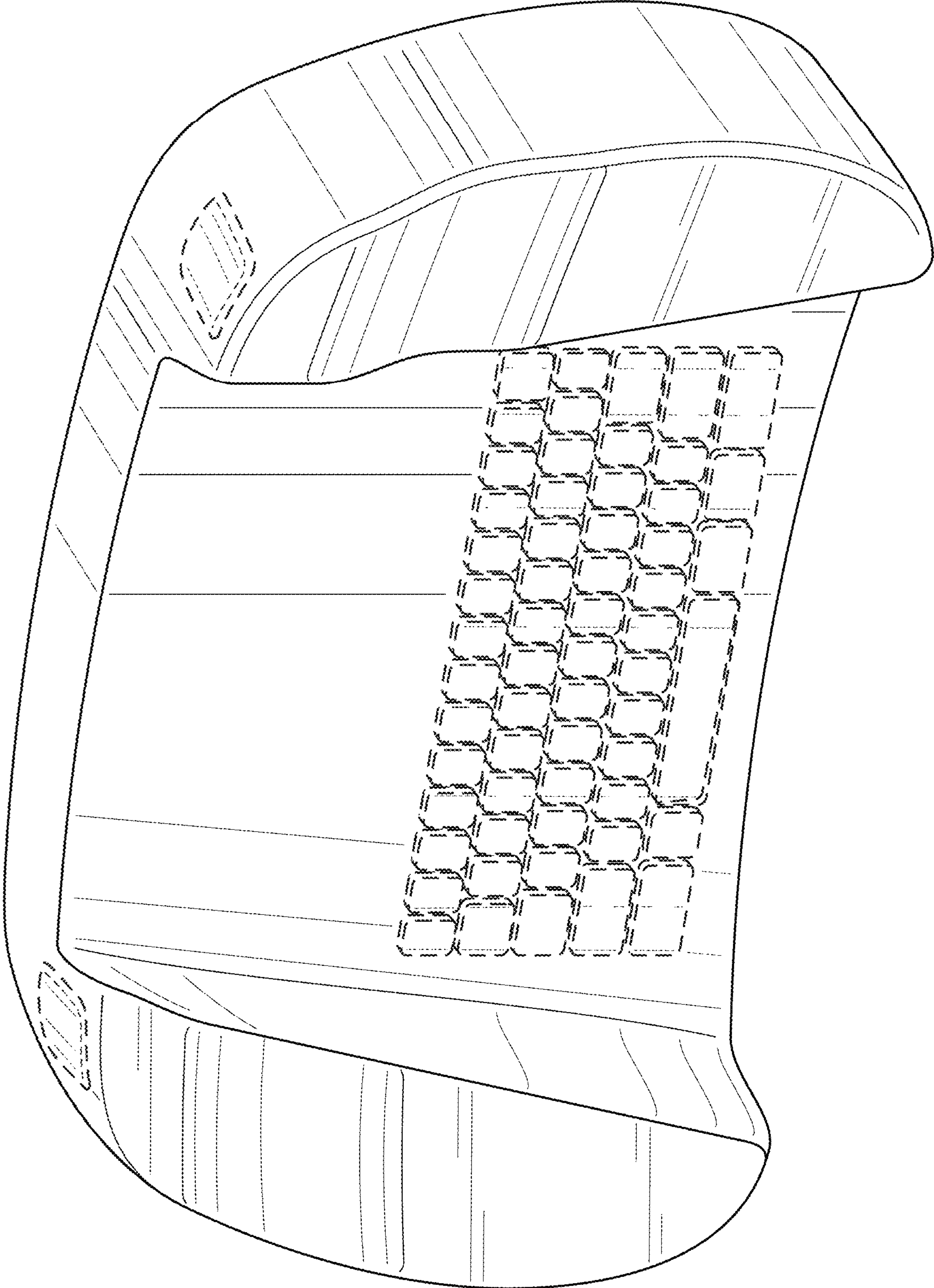

FIG. 8

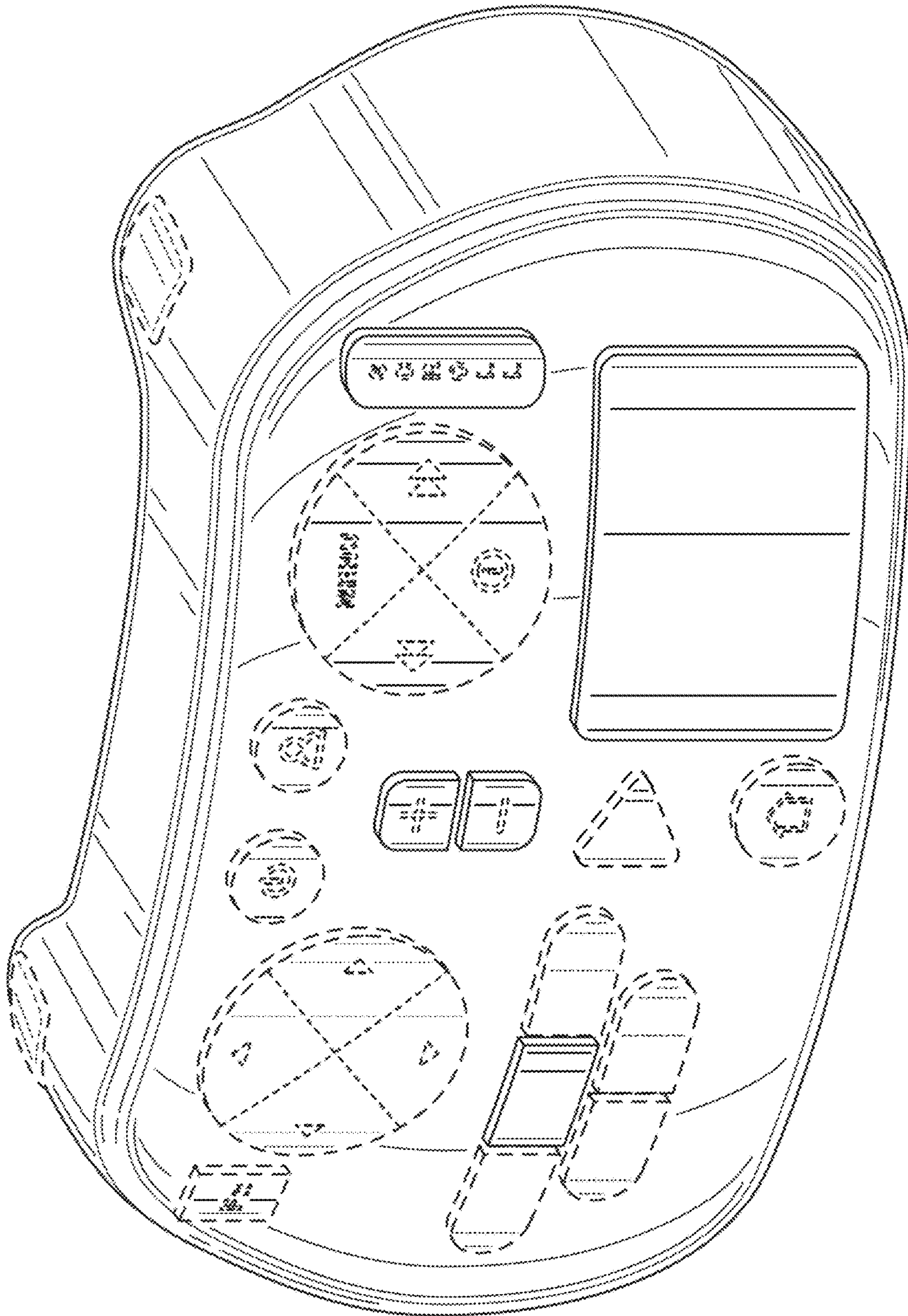

FIG. 9



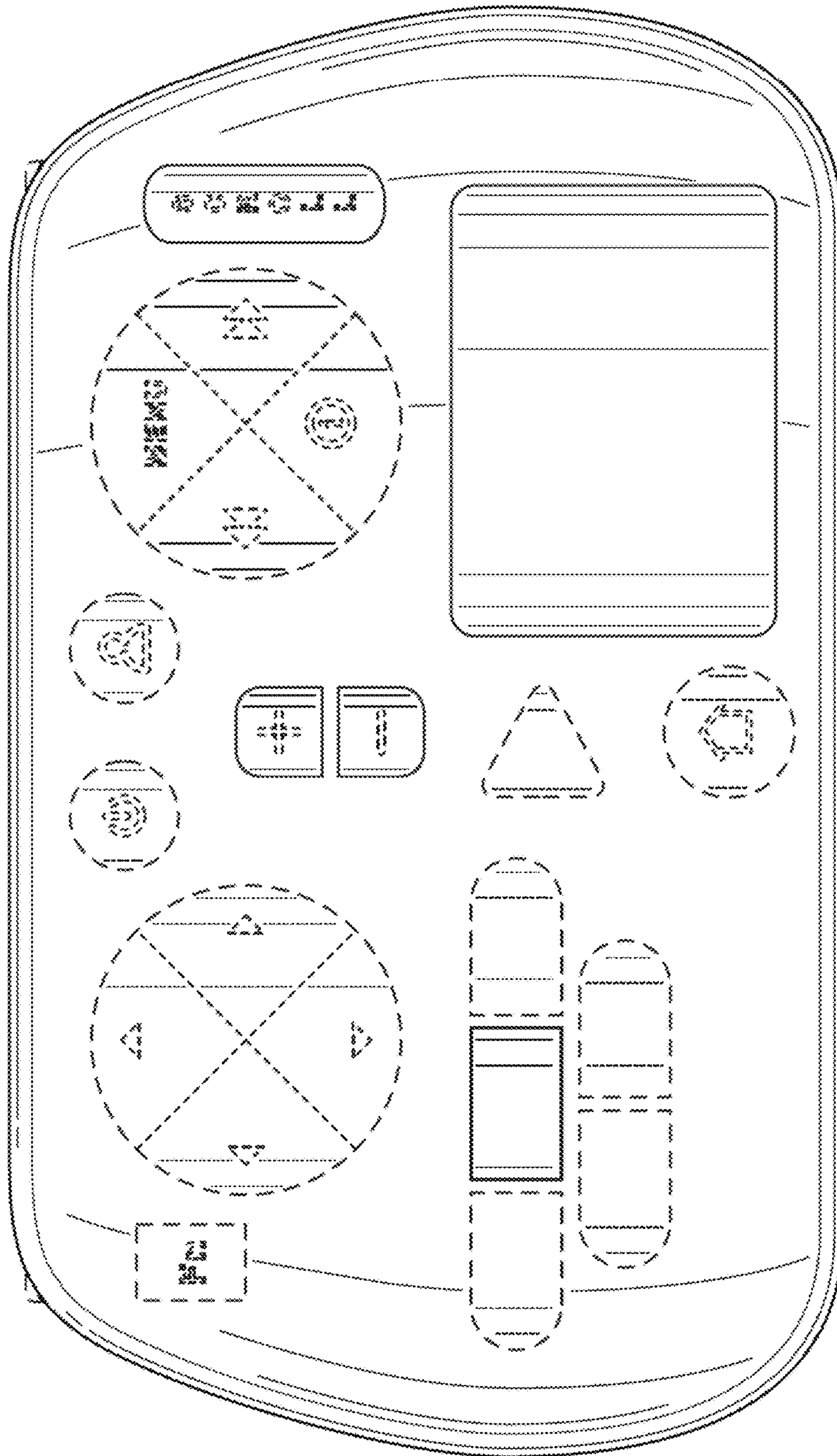

FIG. 10



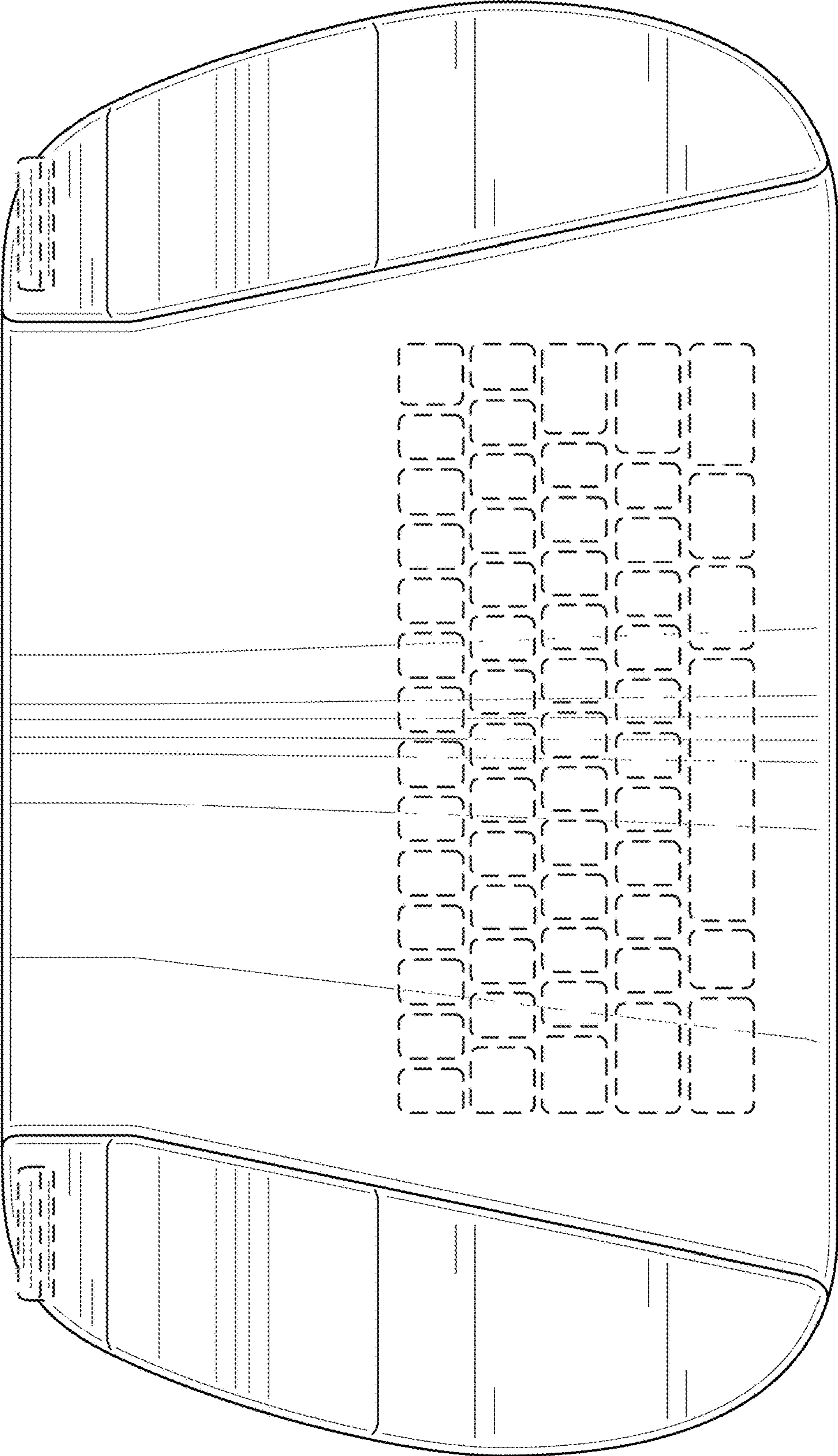

FIG. 11

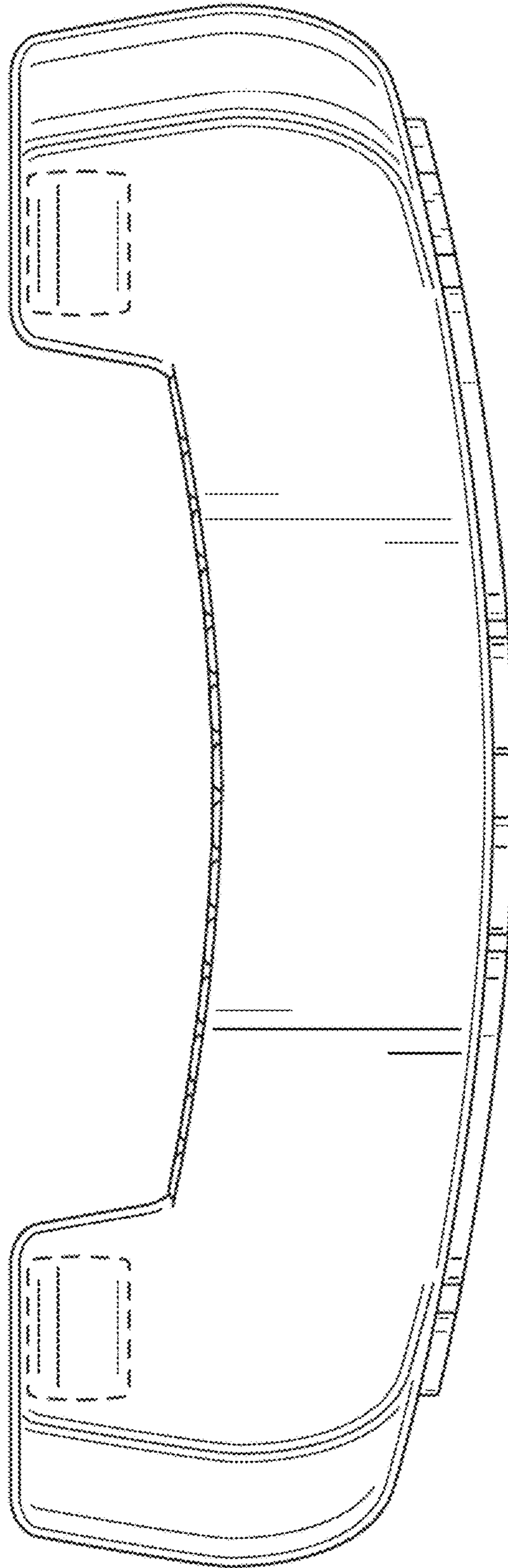

FIG. 12

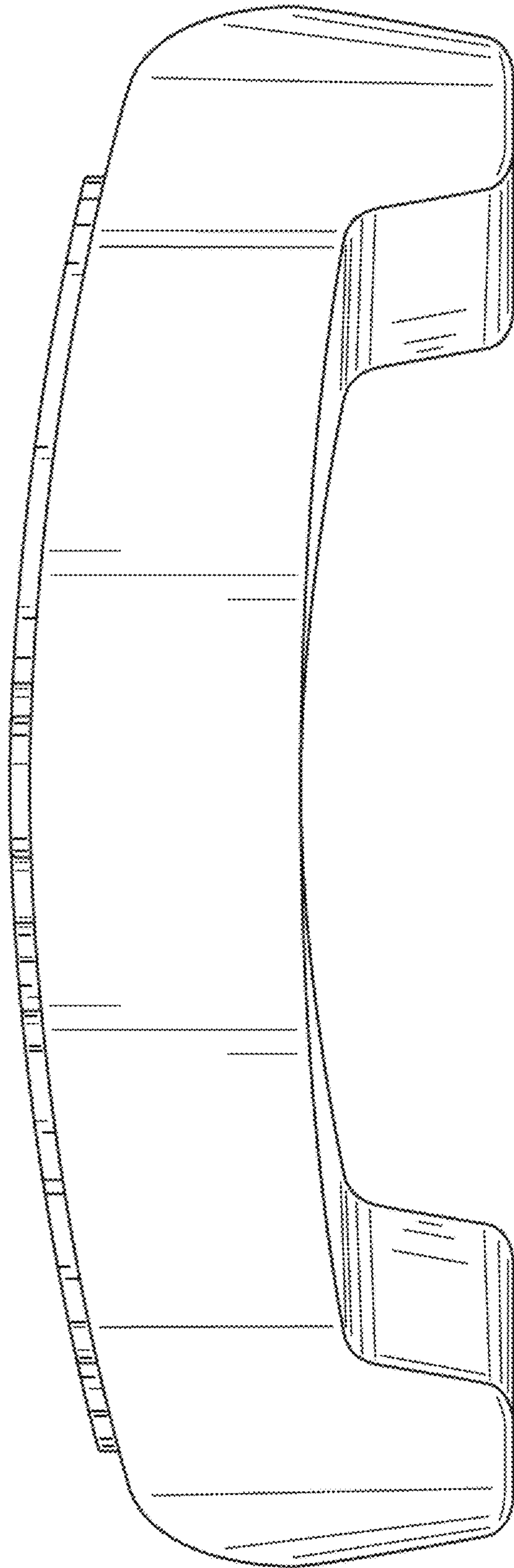

FIG. 13



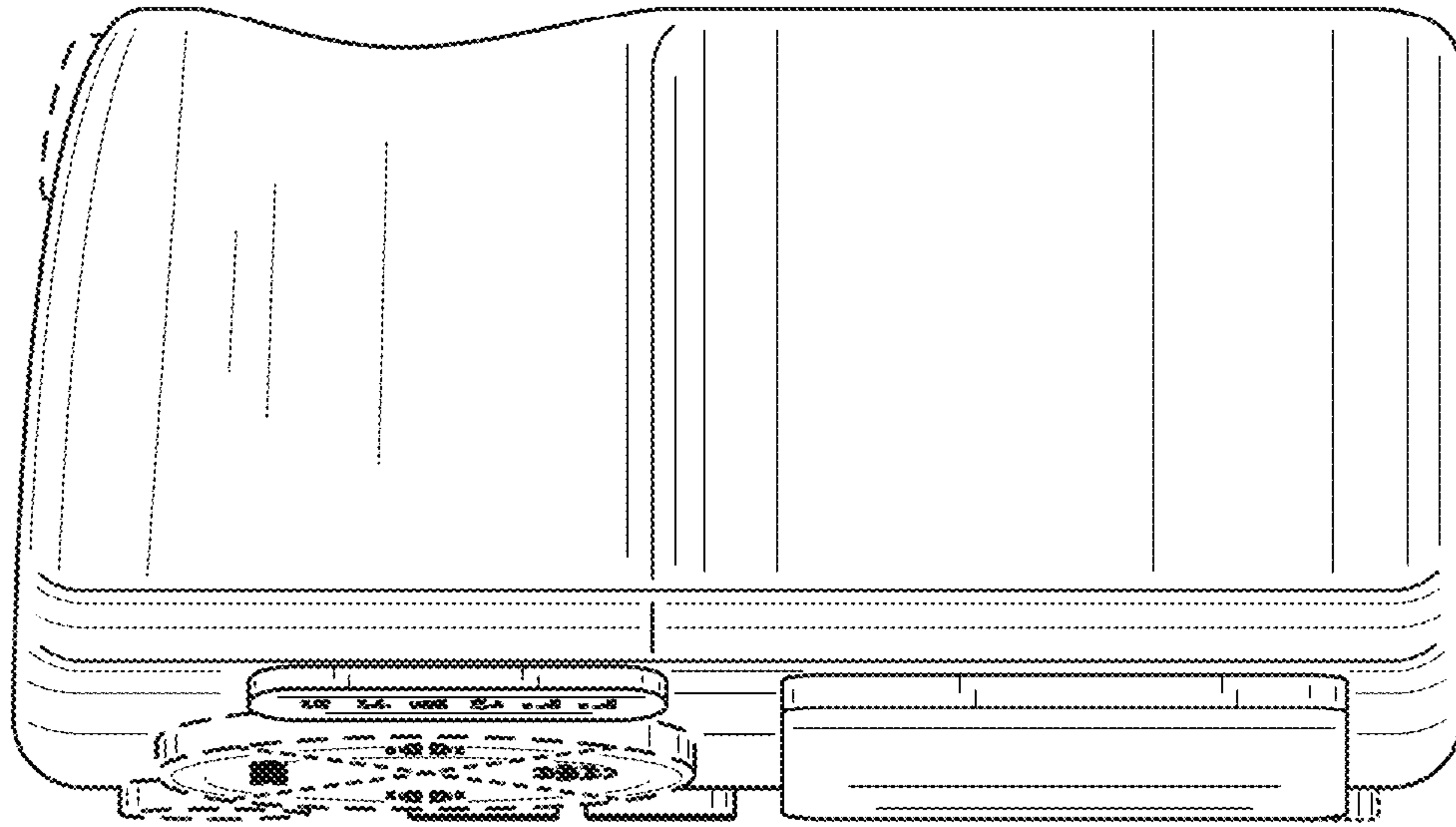

FIG. 14

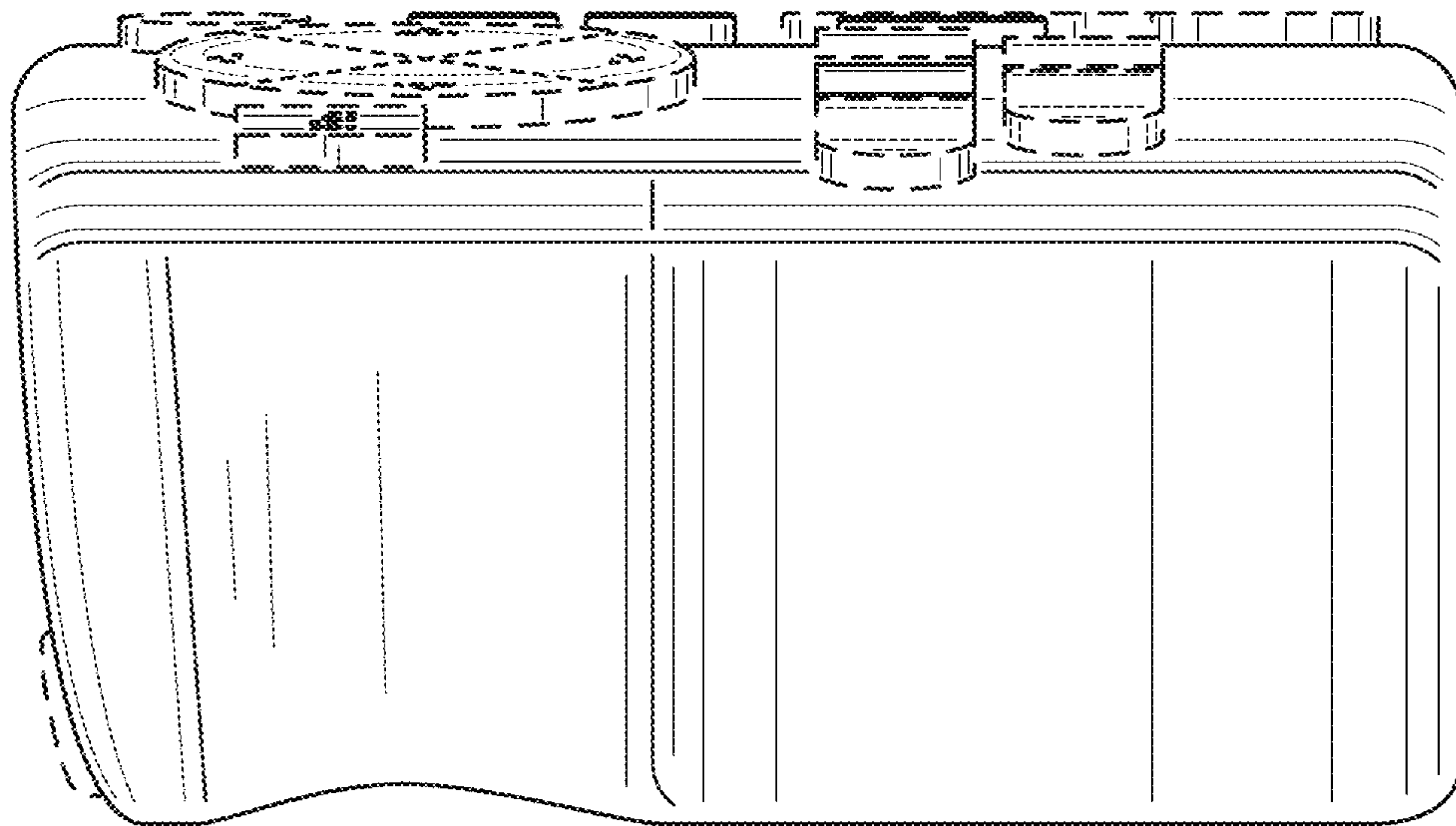

FIG. 15

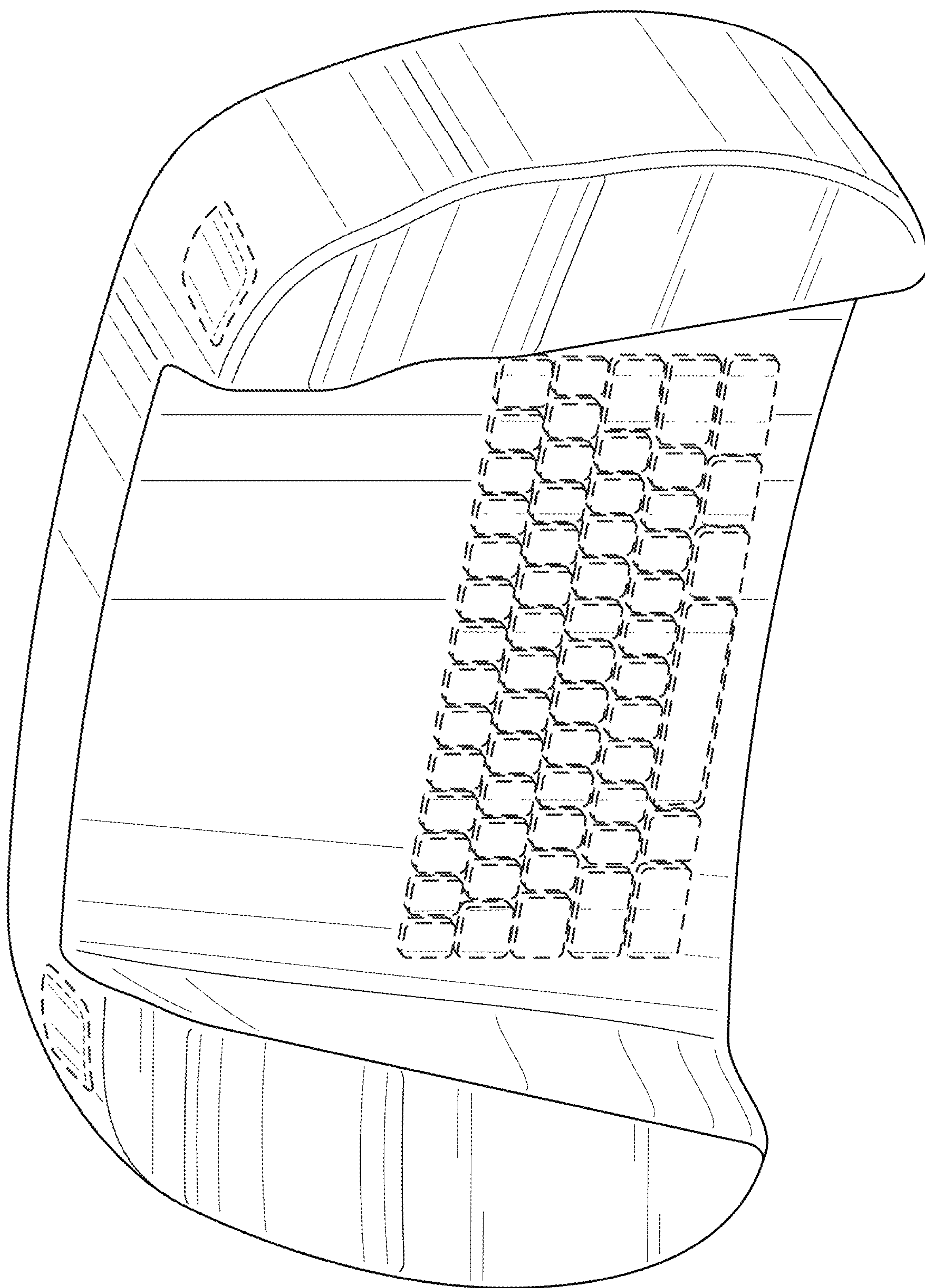

FIG. 16

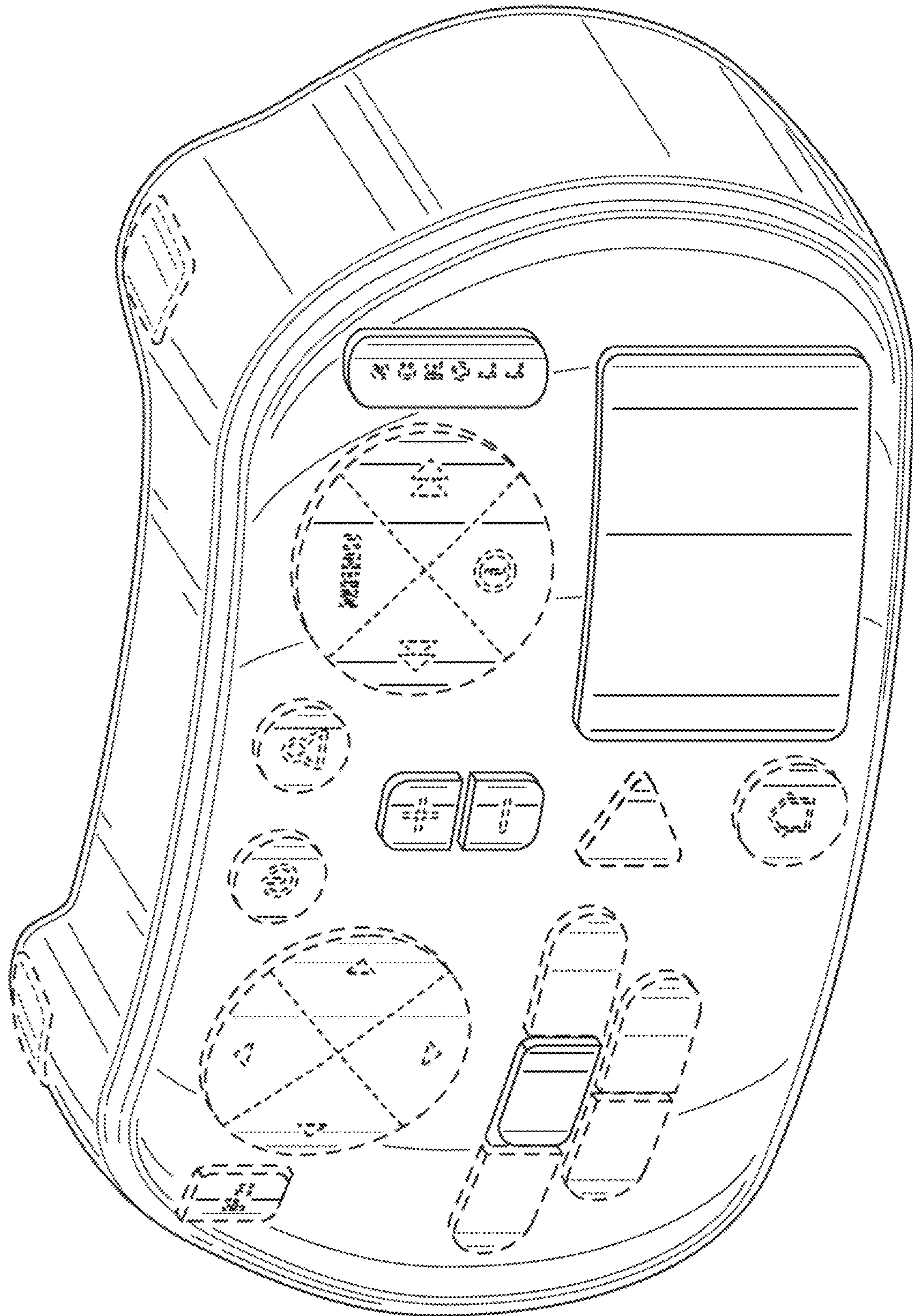

FIG. 17



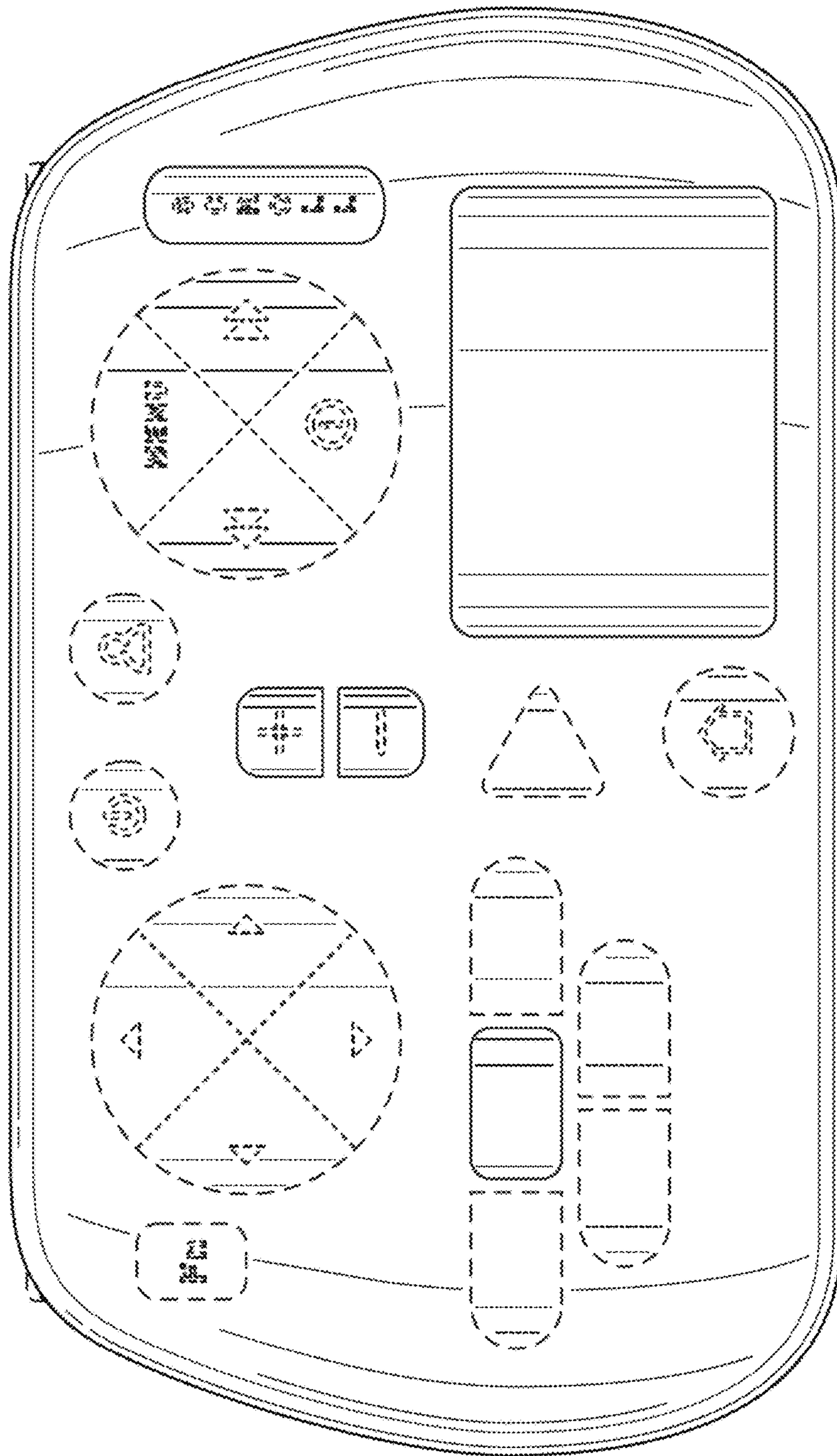

FIG. 18

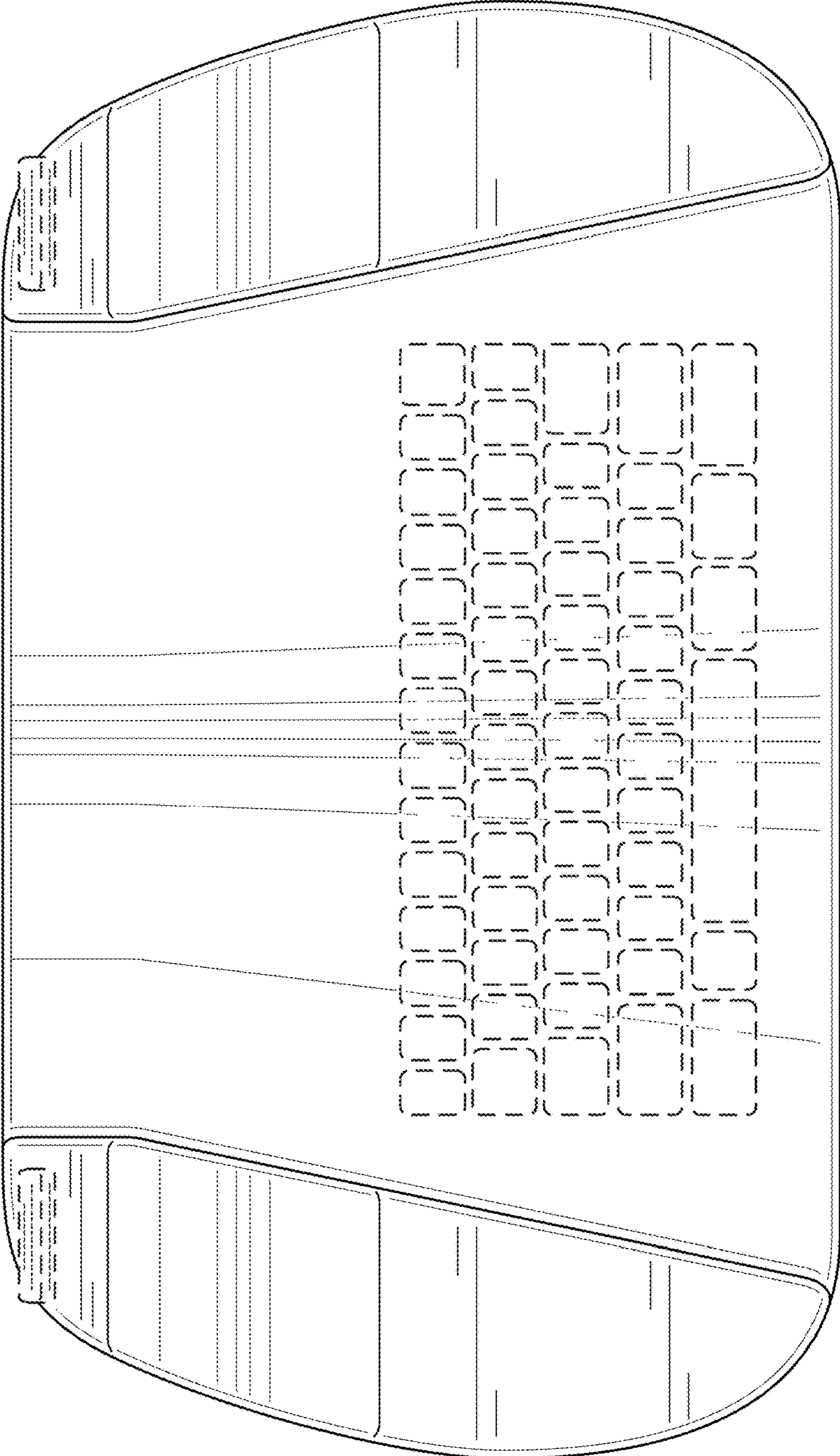

FIG. 19

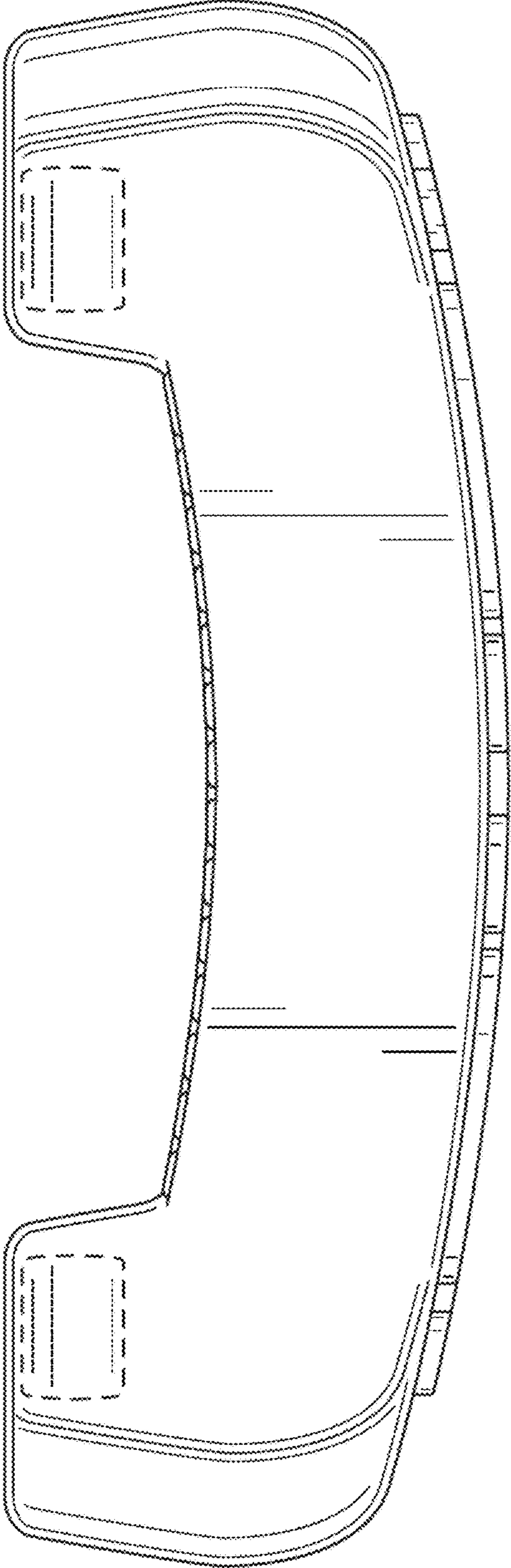

FIG. 20



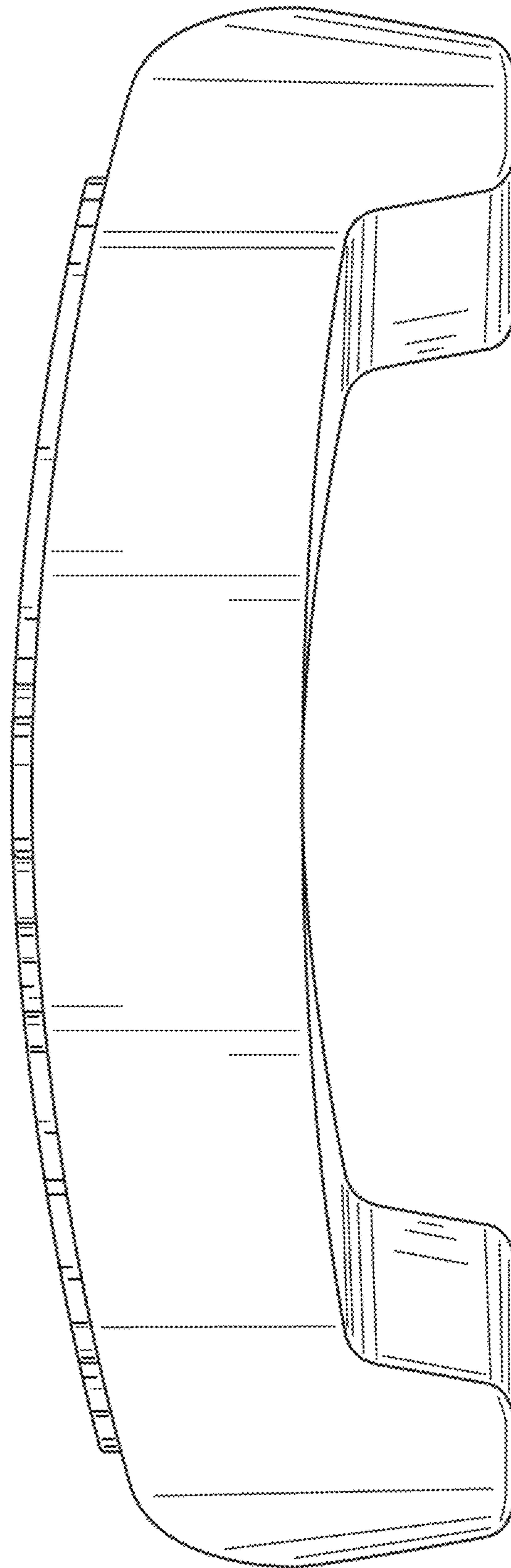

FIG. 21

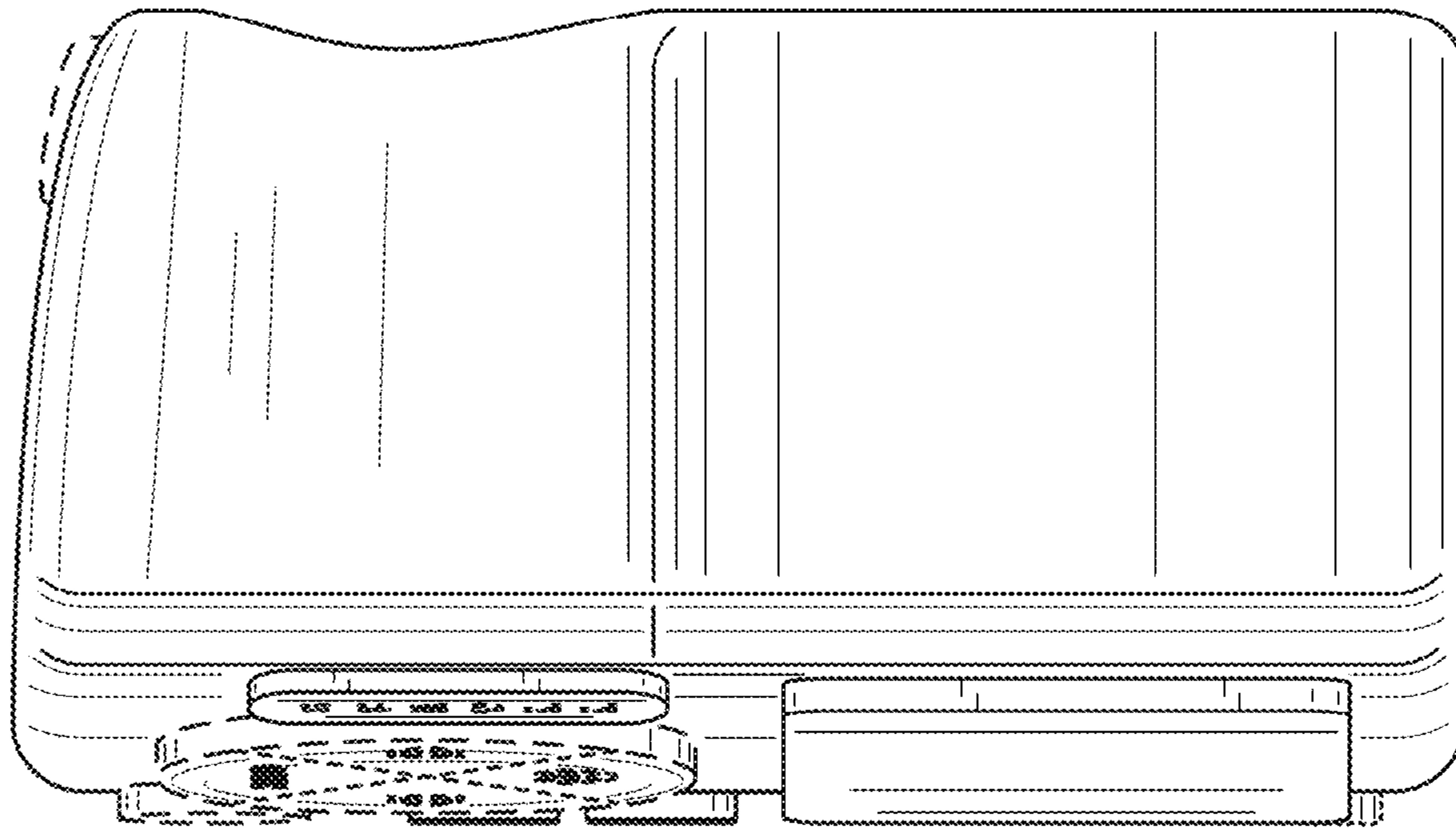

FIG. 22

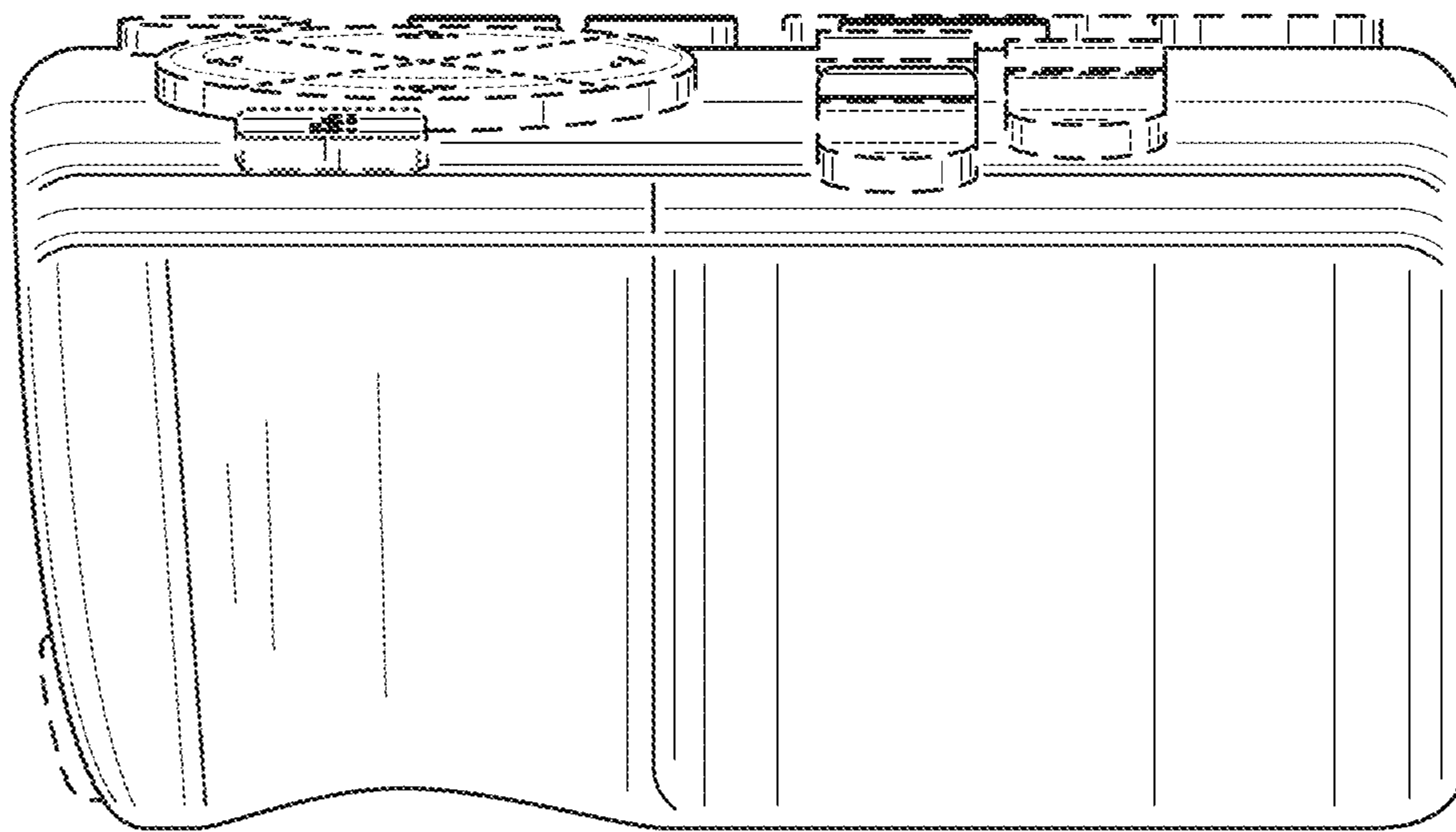

FIG. 23

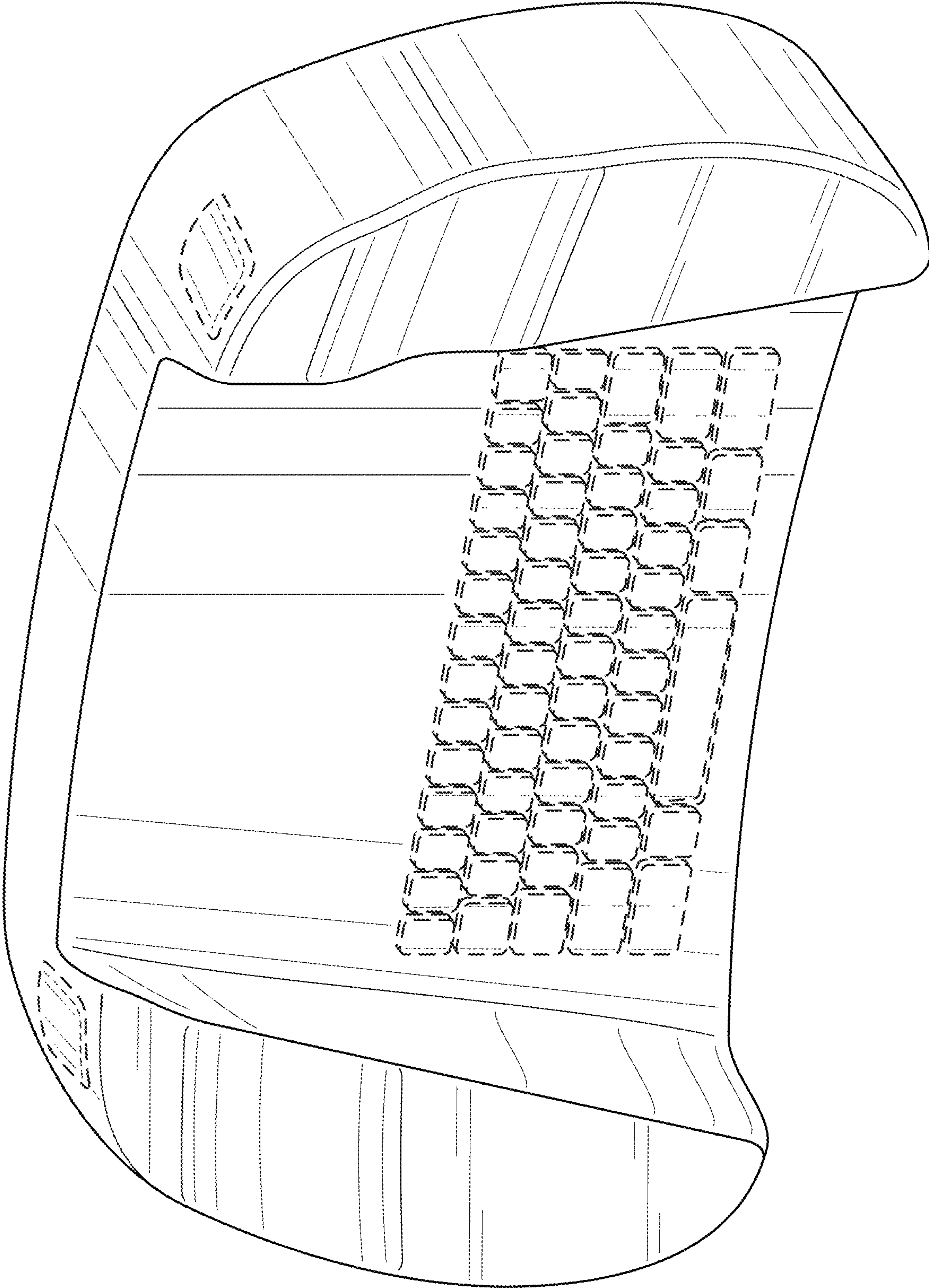

FIG. 24



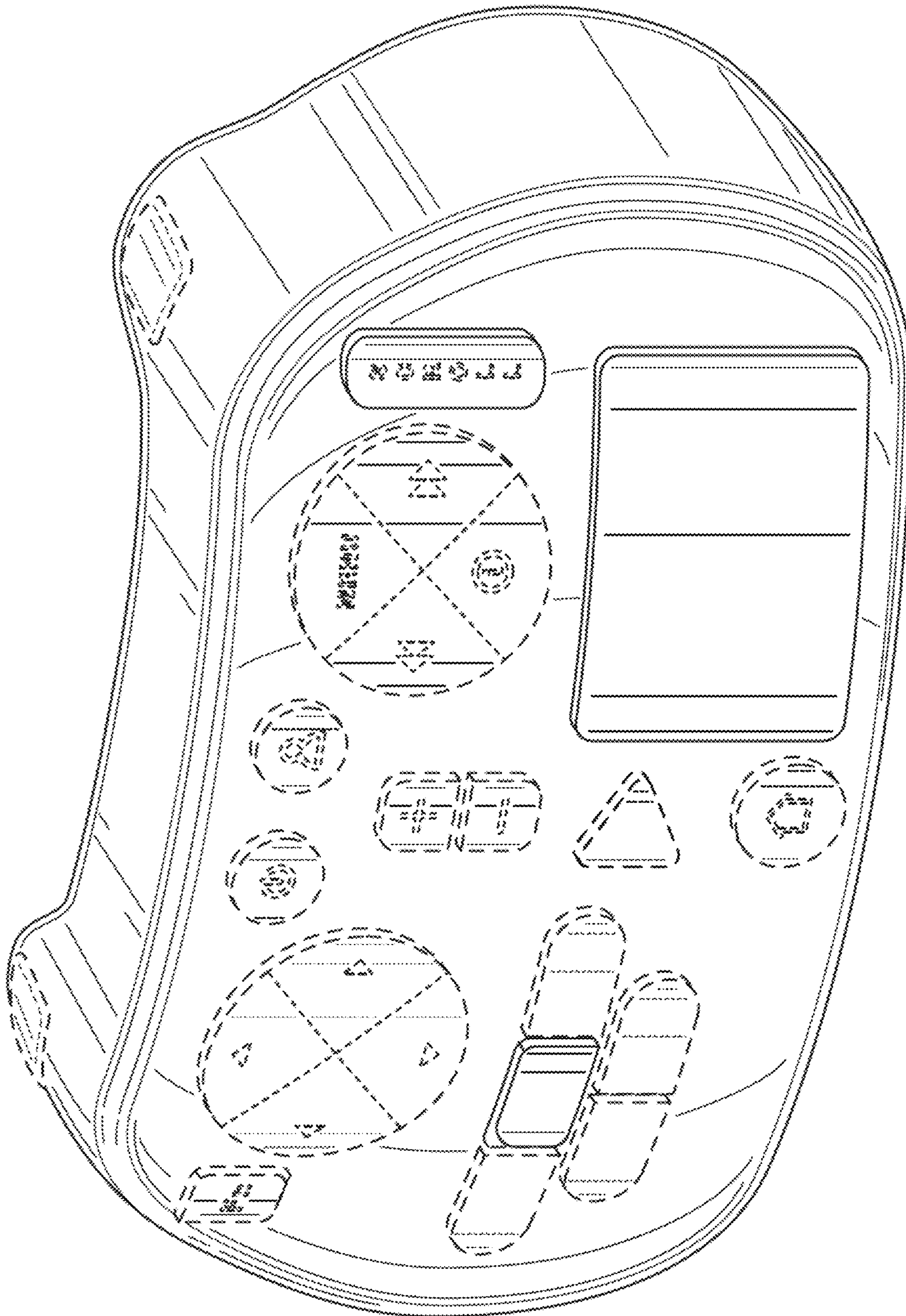

FIG. 25

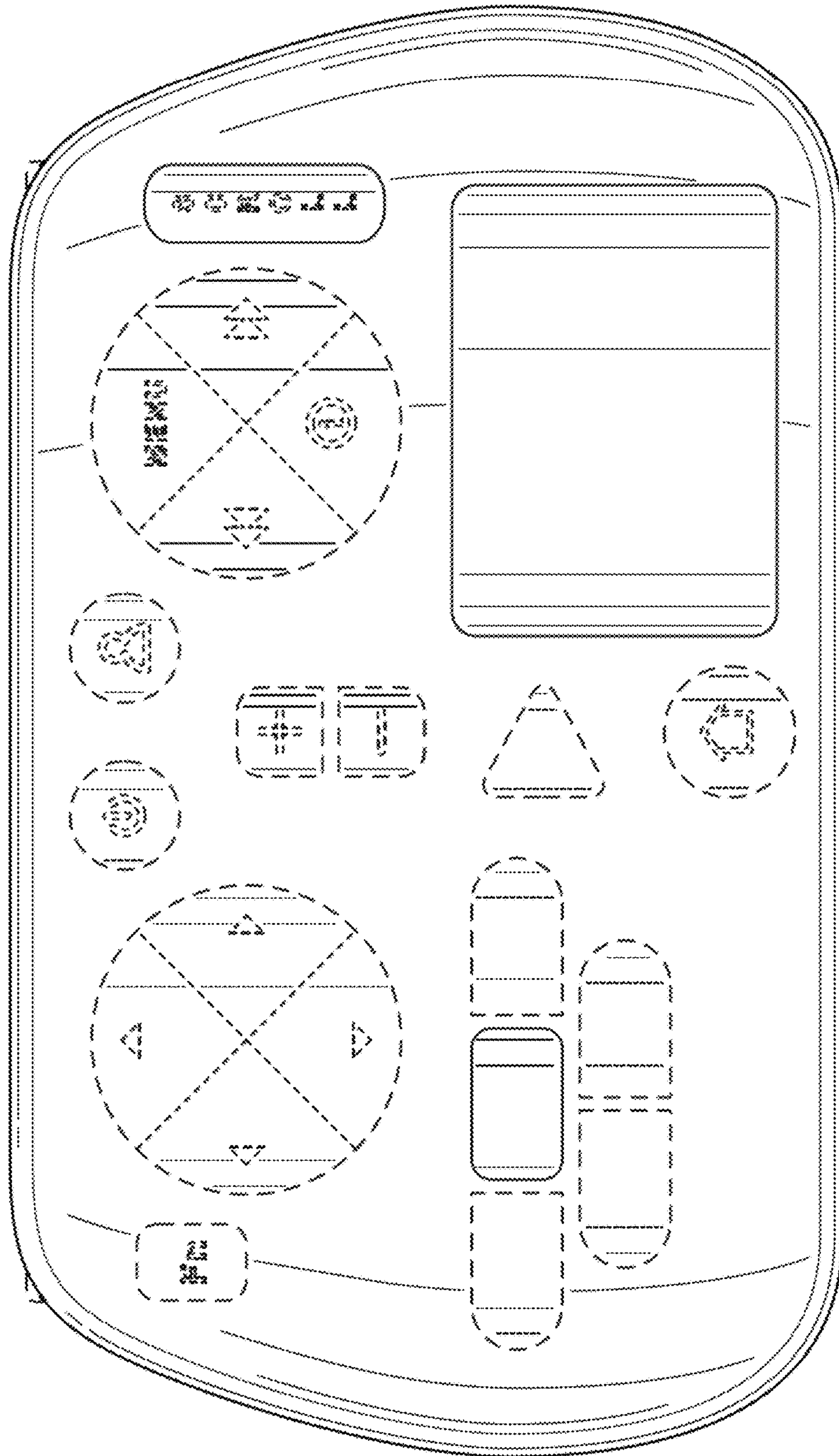

FIG. 26



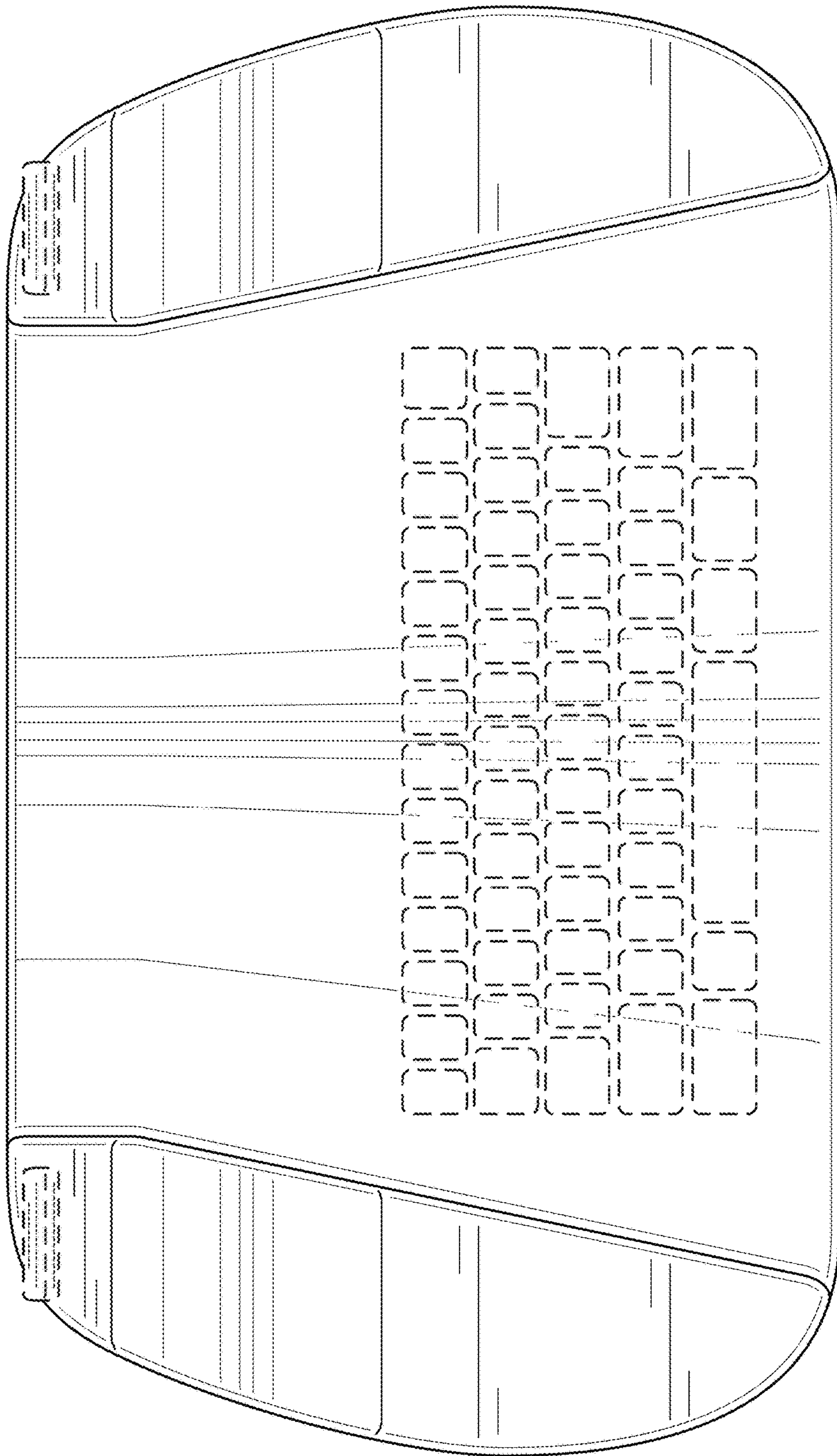

FIG. 27



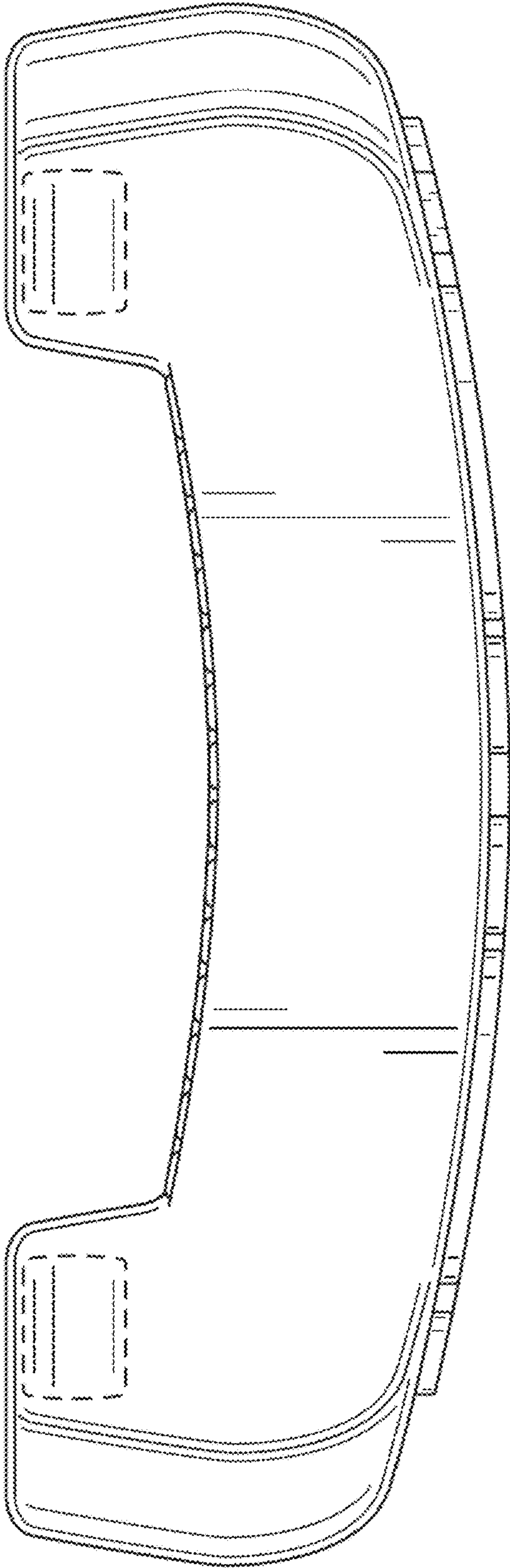

FIG. 28

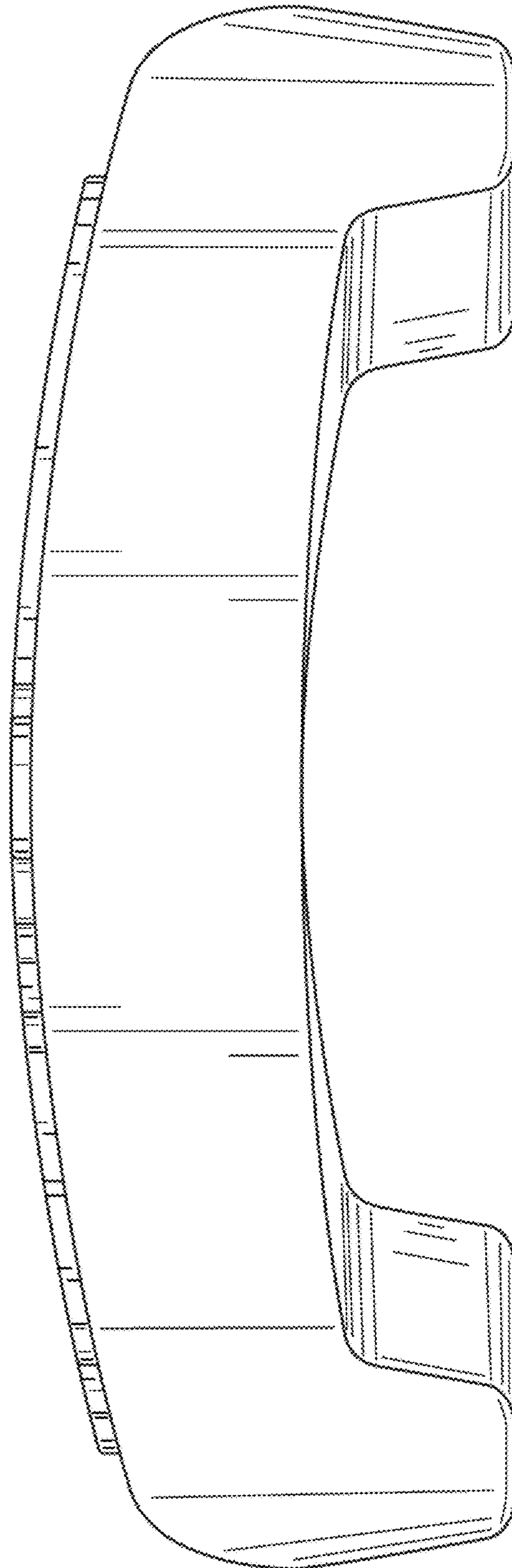

FIG. 29

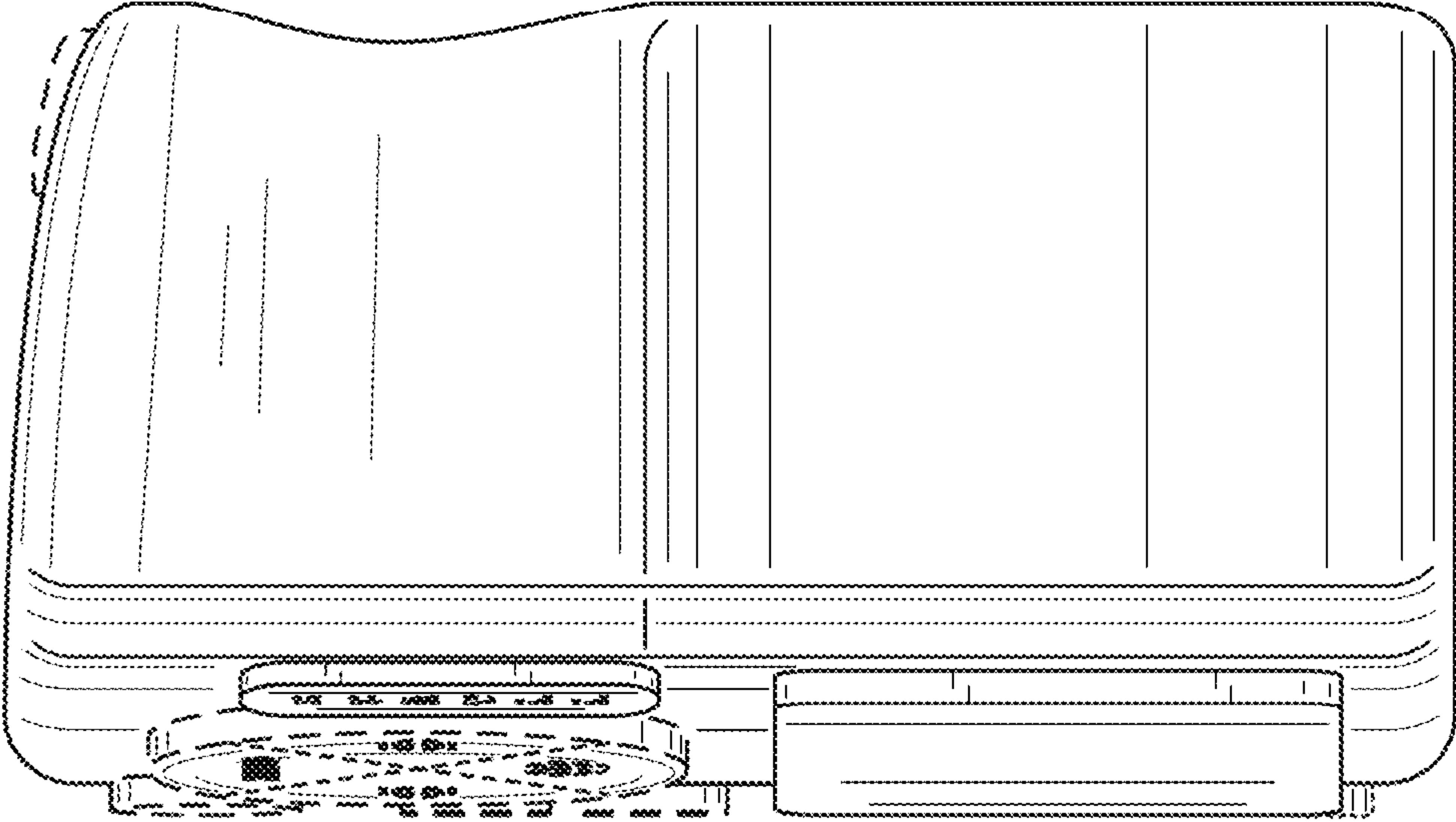

FIG. 30

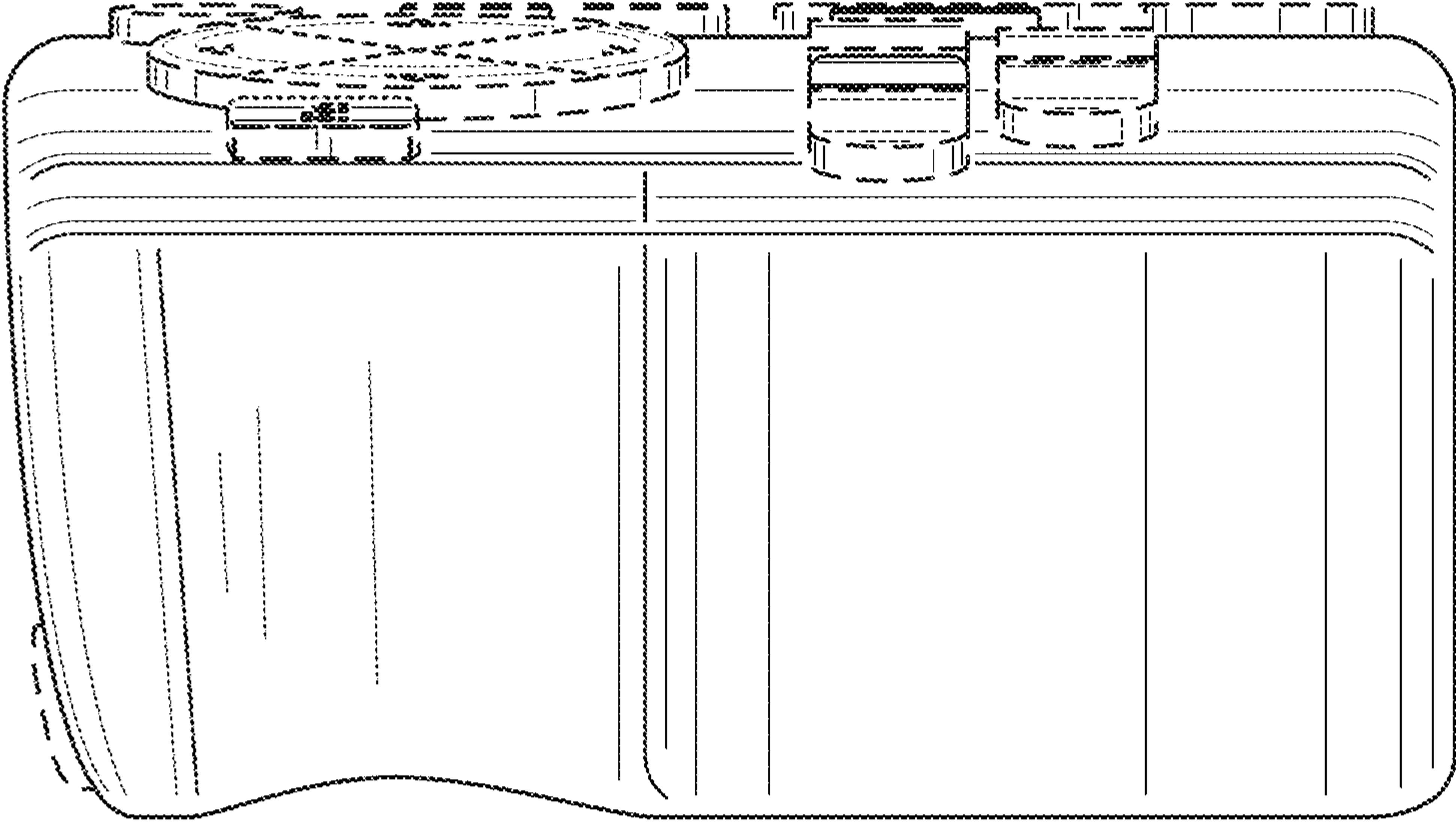

FIG. 31



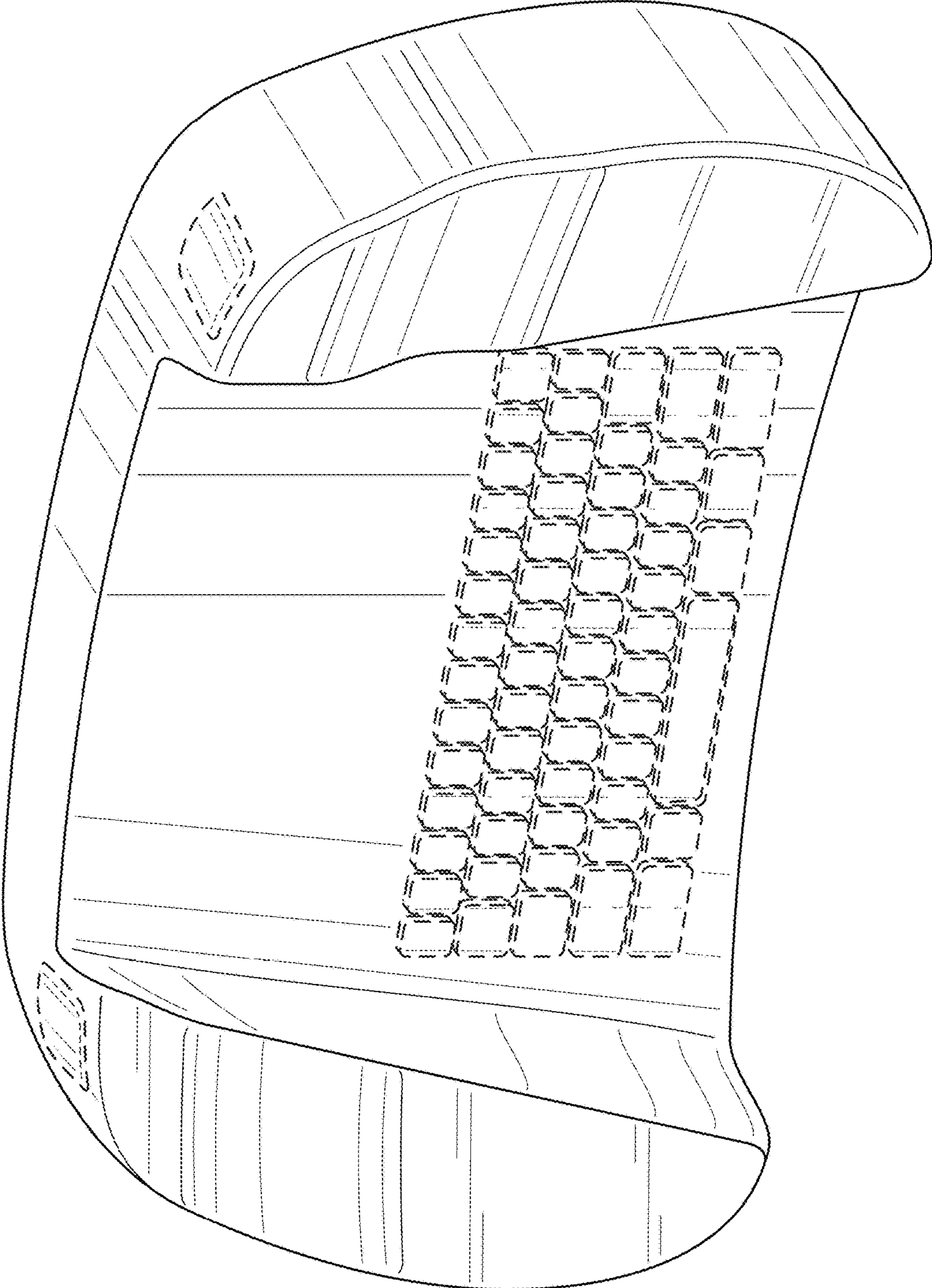

FIG. 32

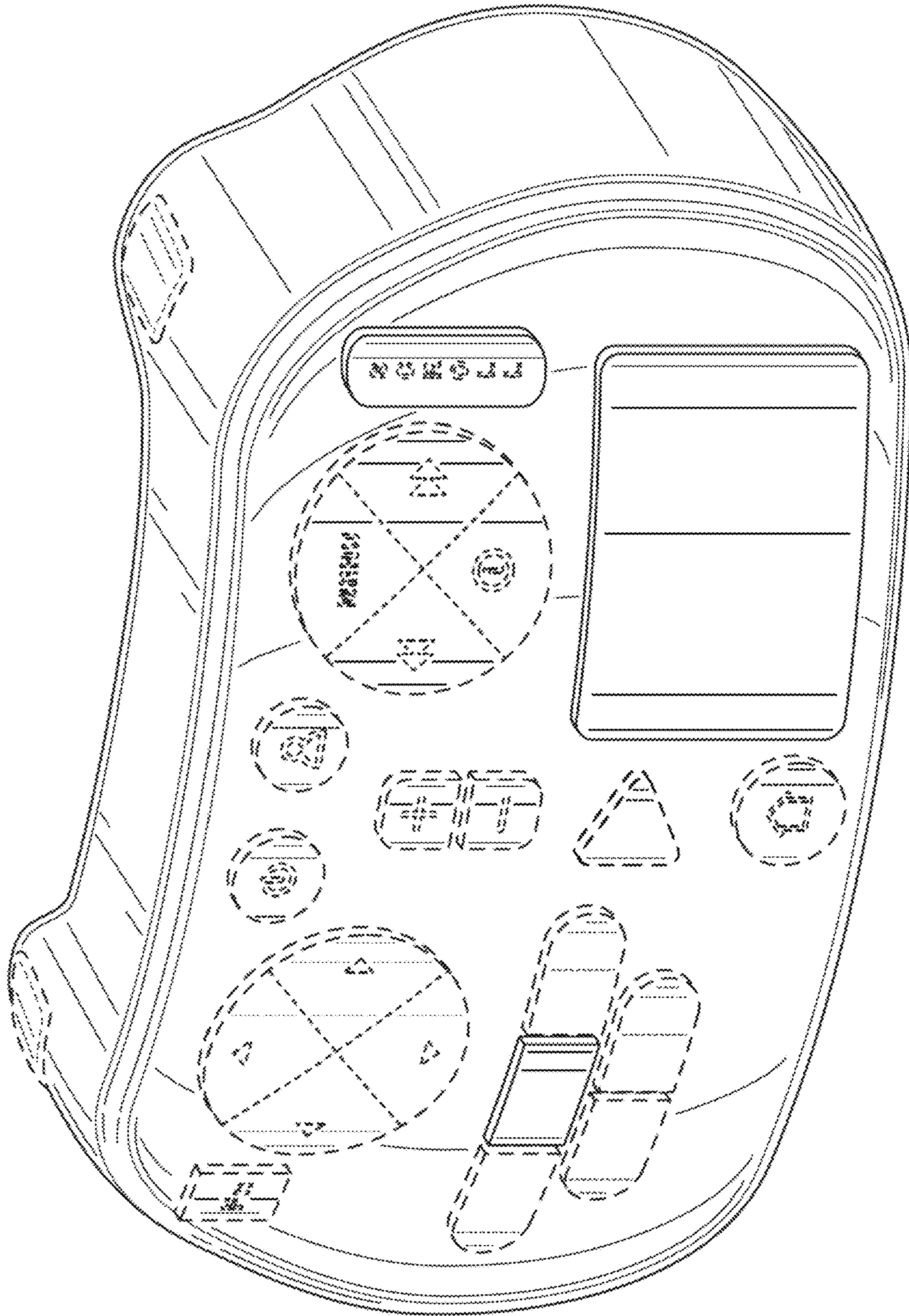

FIG. 33



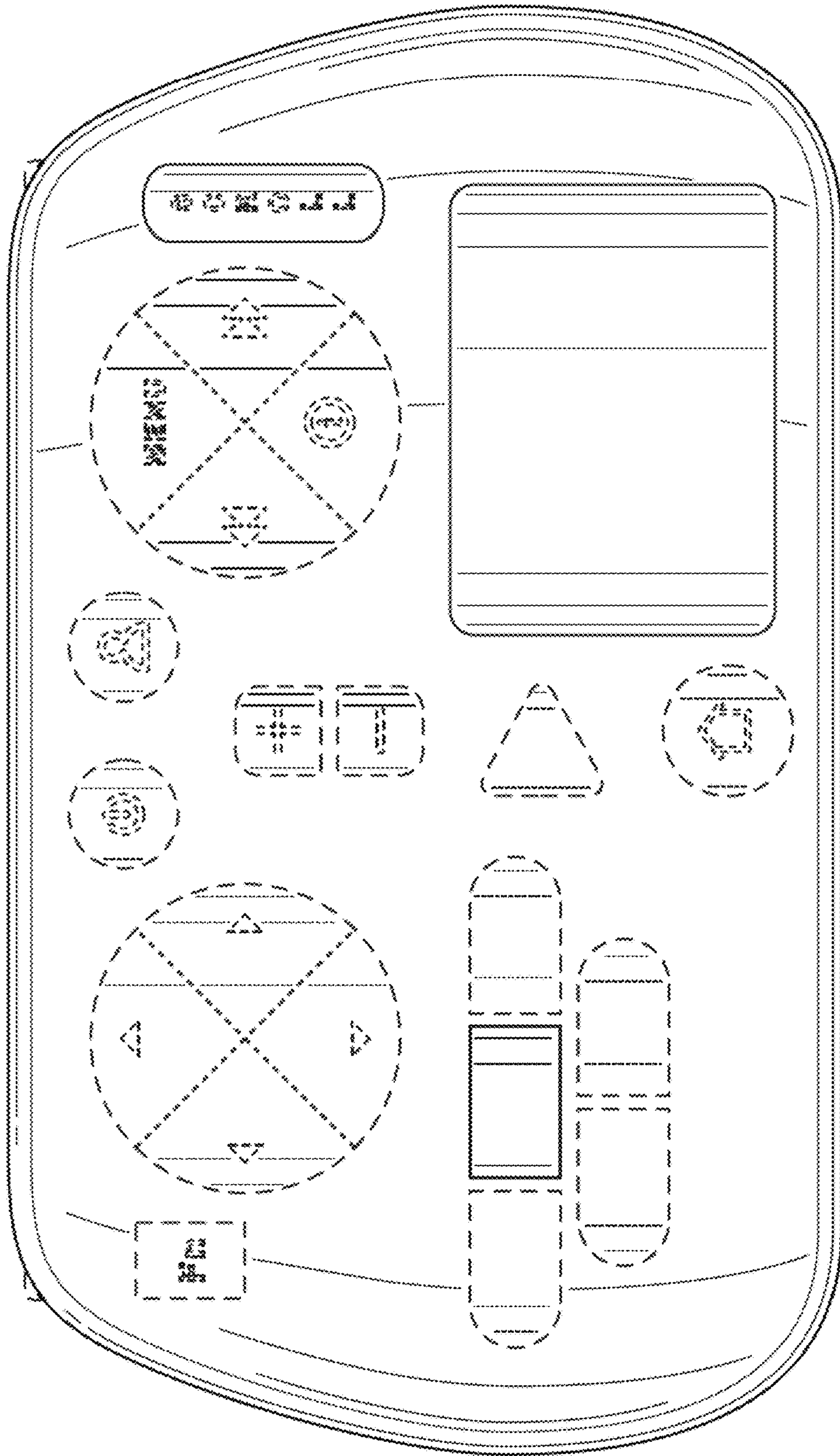

FIG. 34



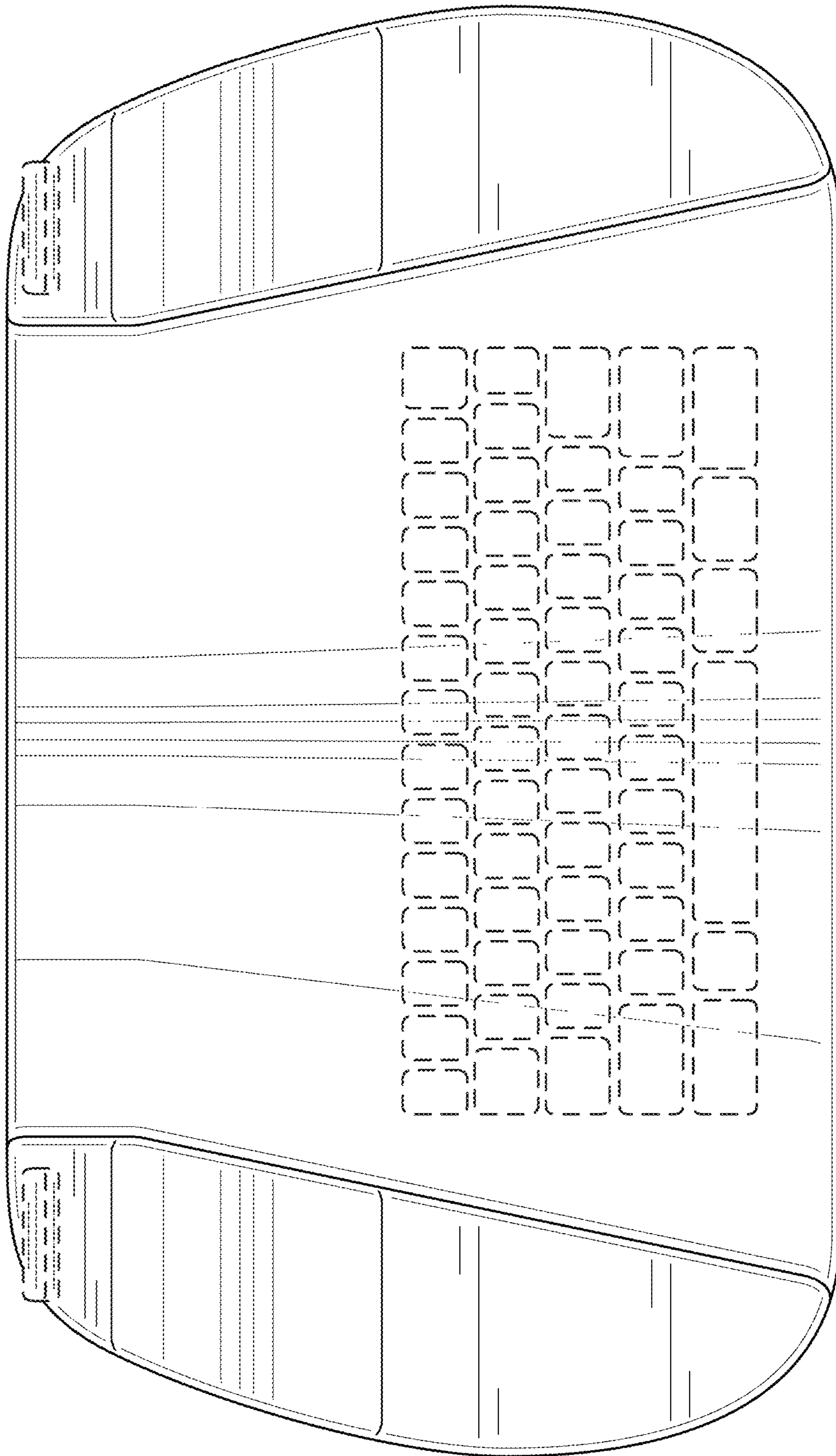

FIG. 35

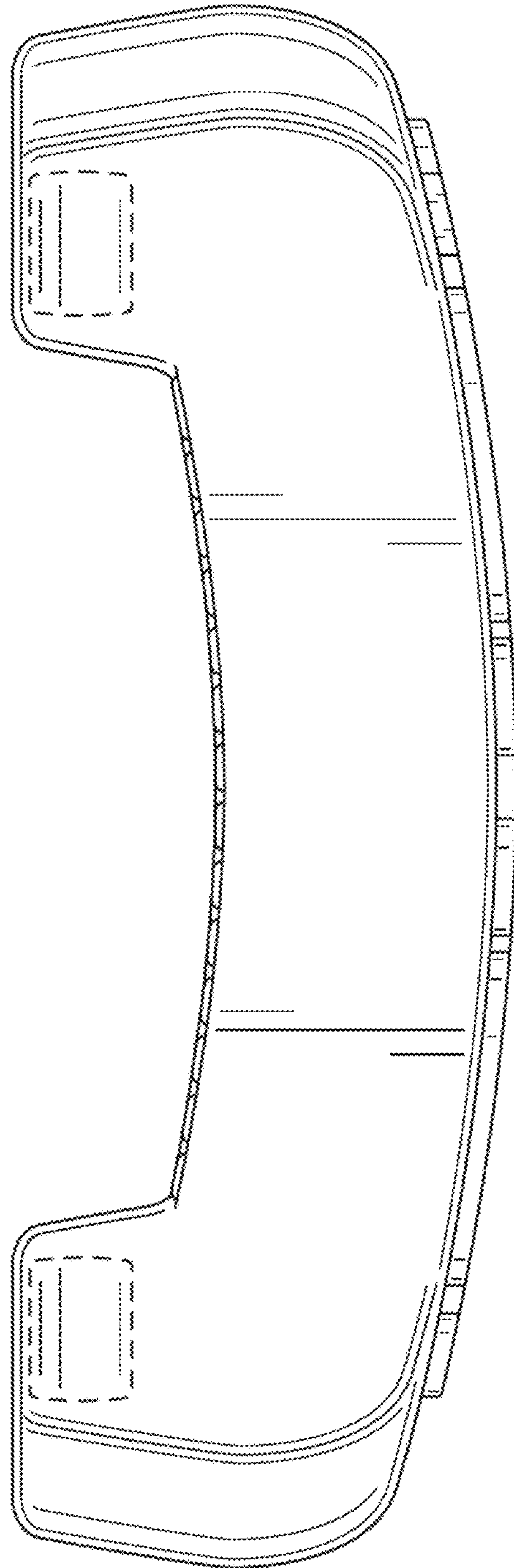

FIG. 36

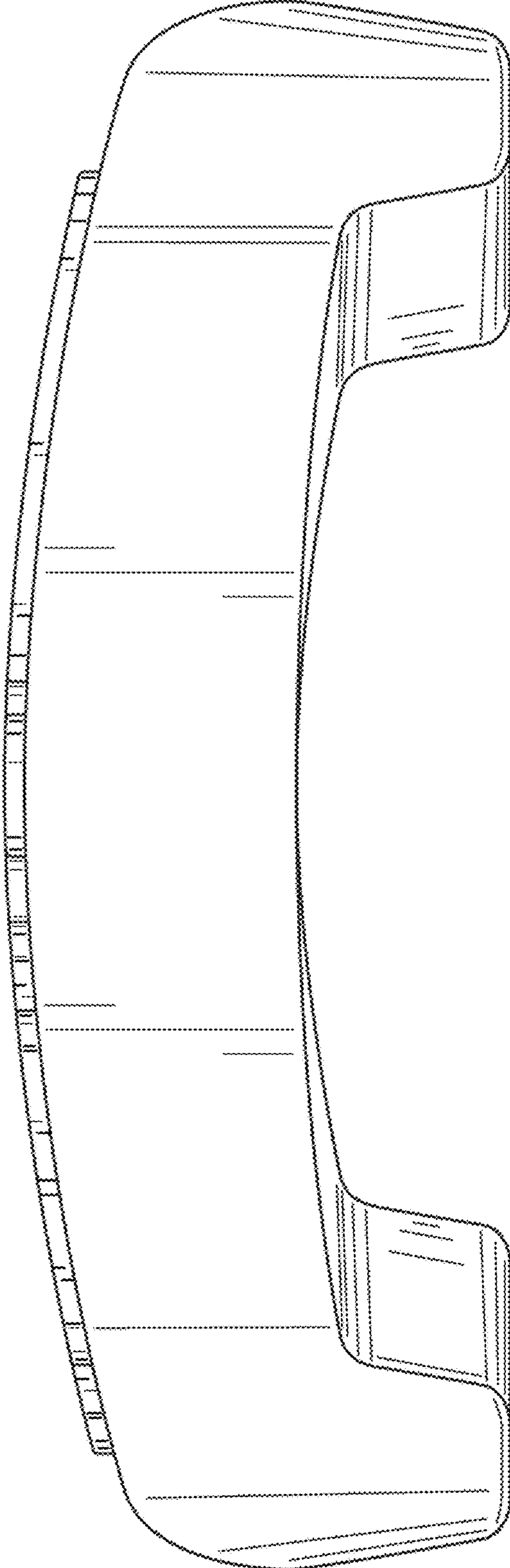

FIG. 37



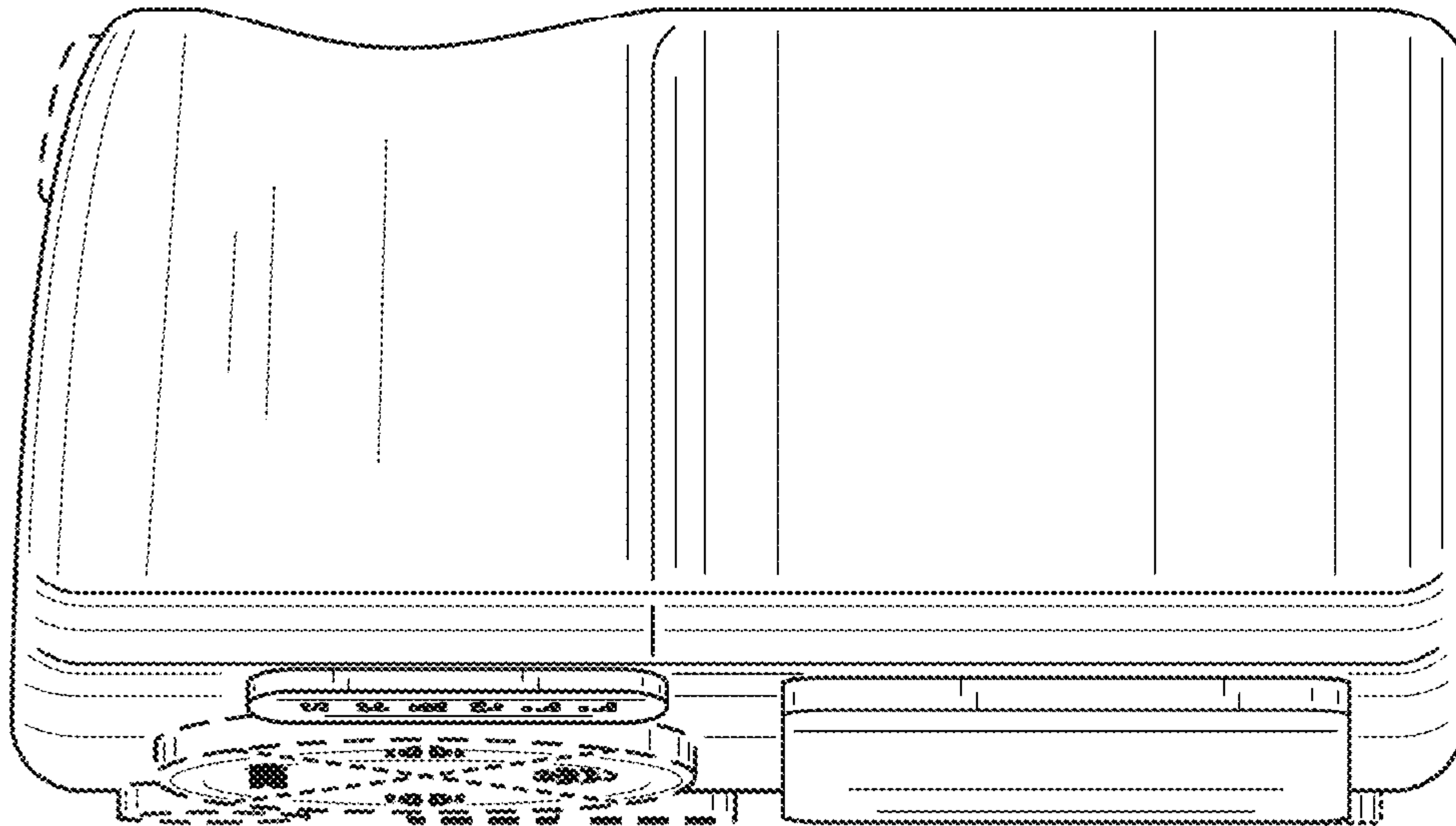

FIG. 38

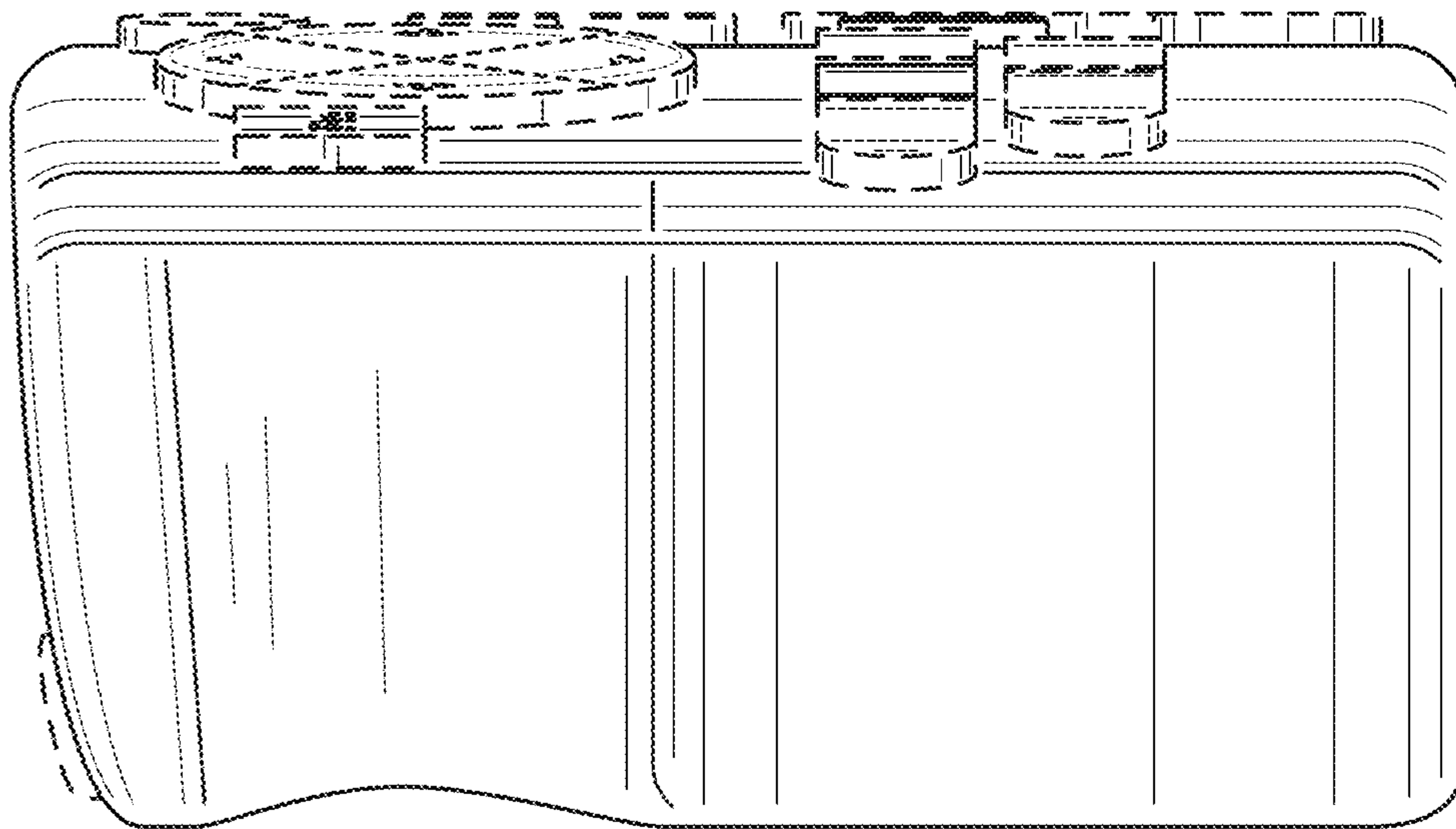

FIG. 39

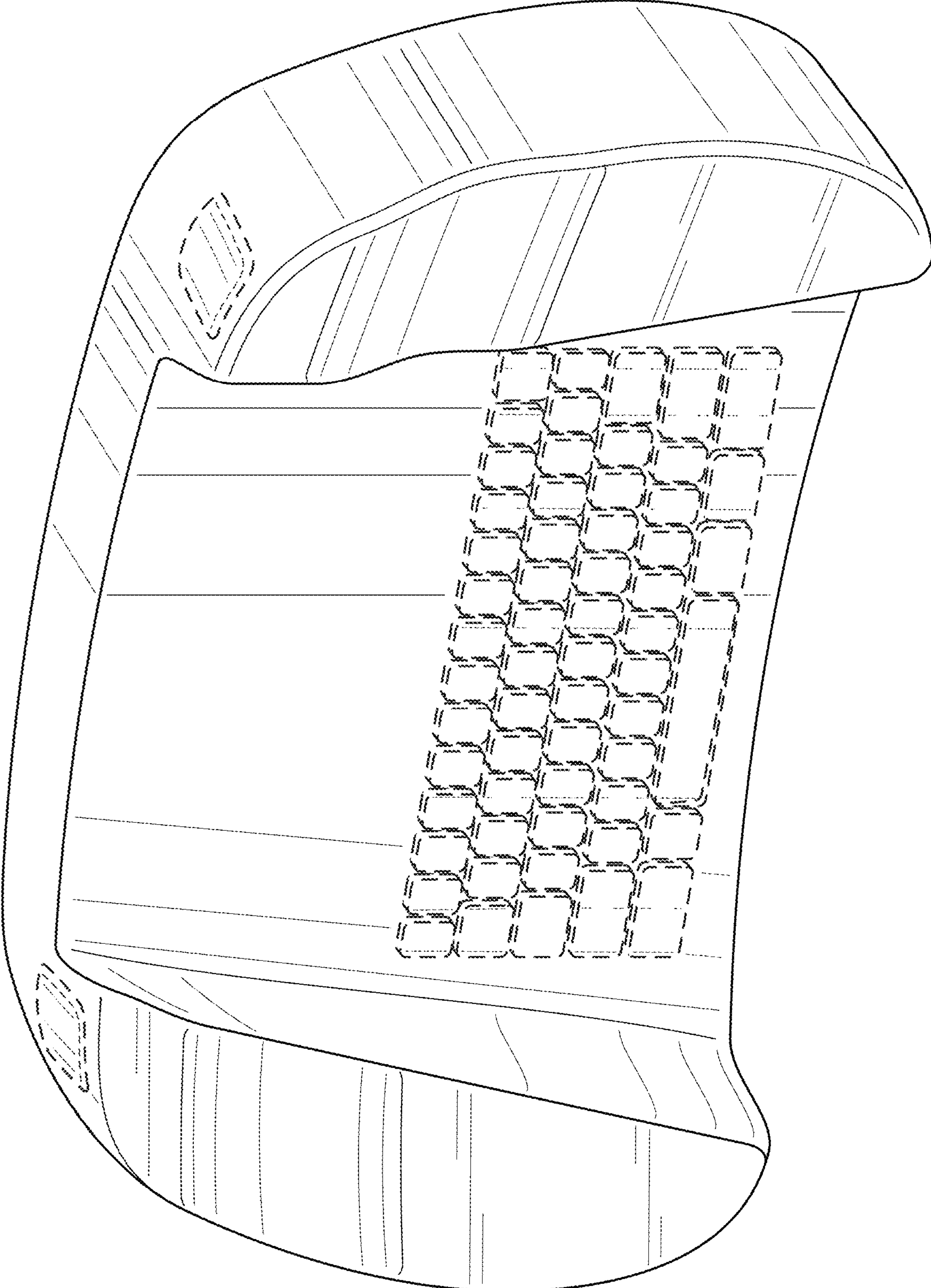

FIG. 40

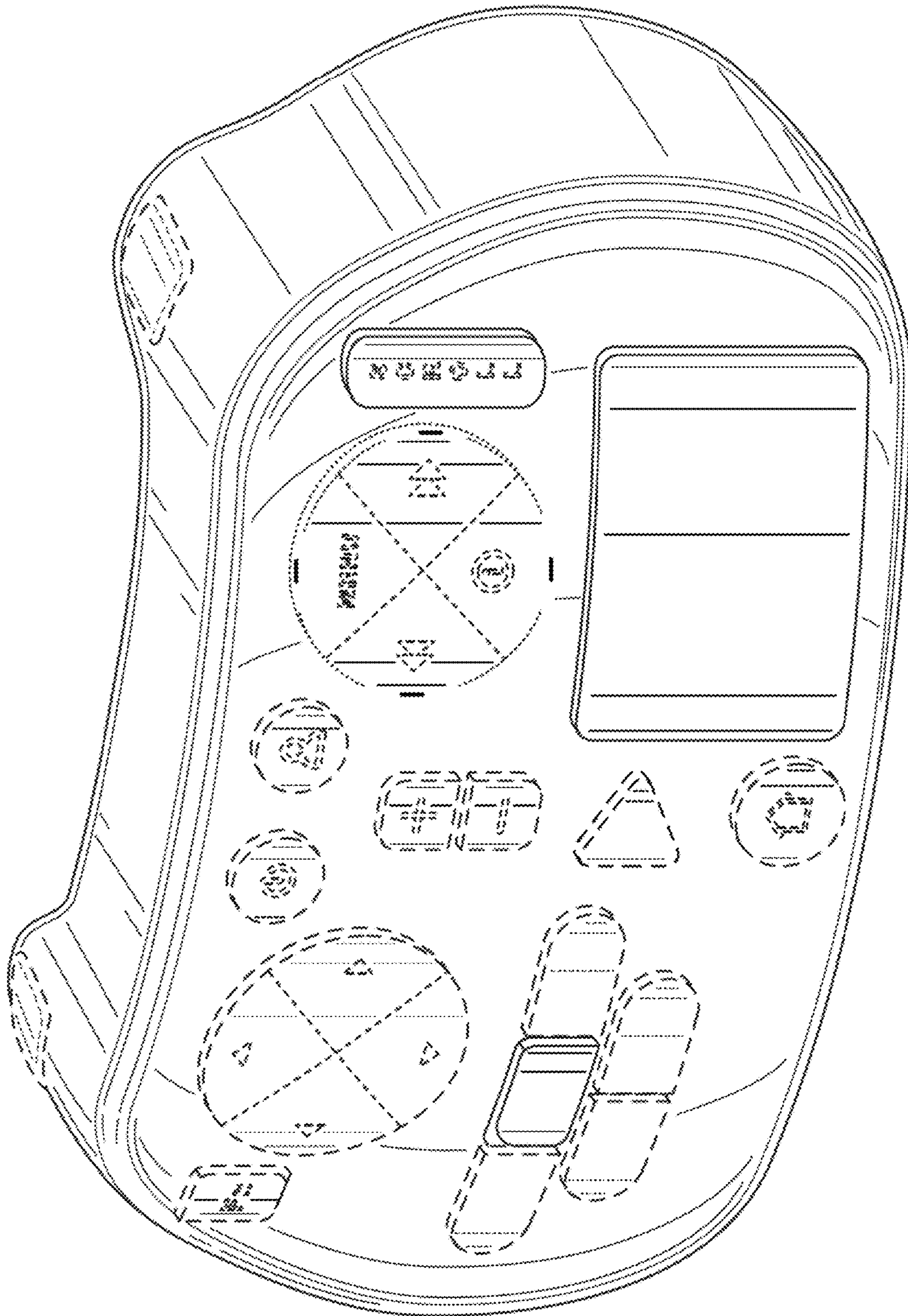

FIG. 41



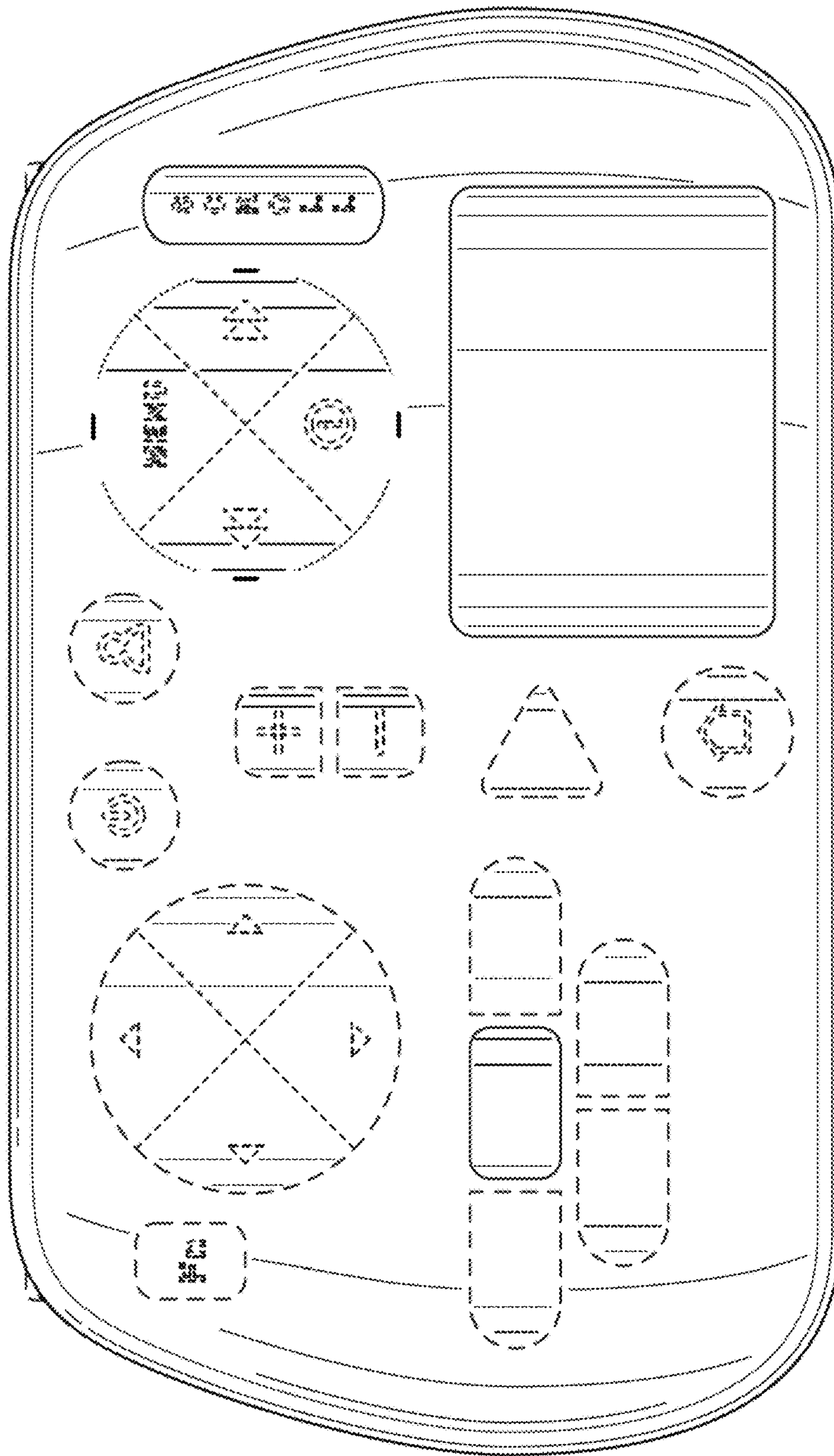

FIG. 42

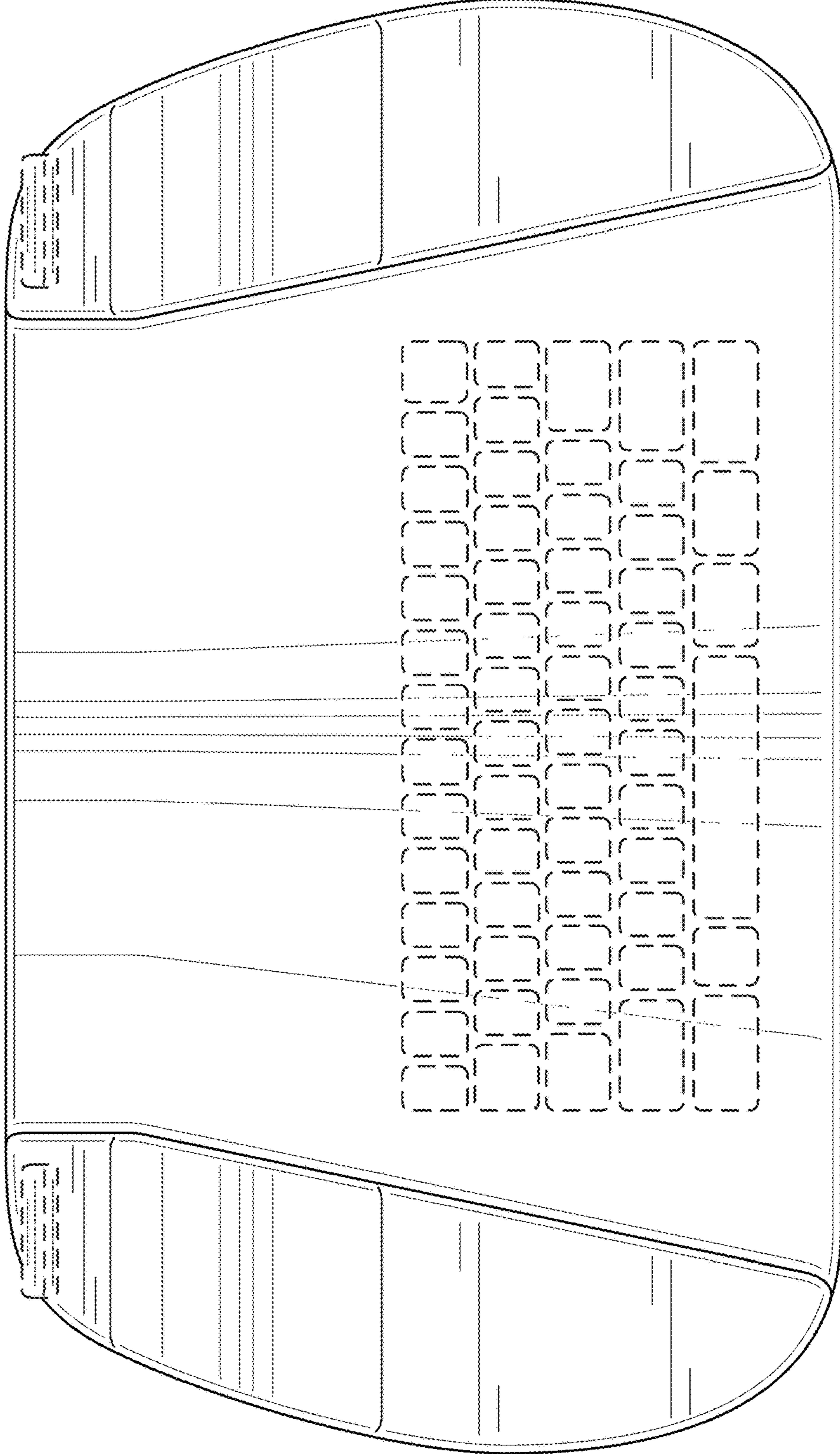

FIG. 43

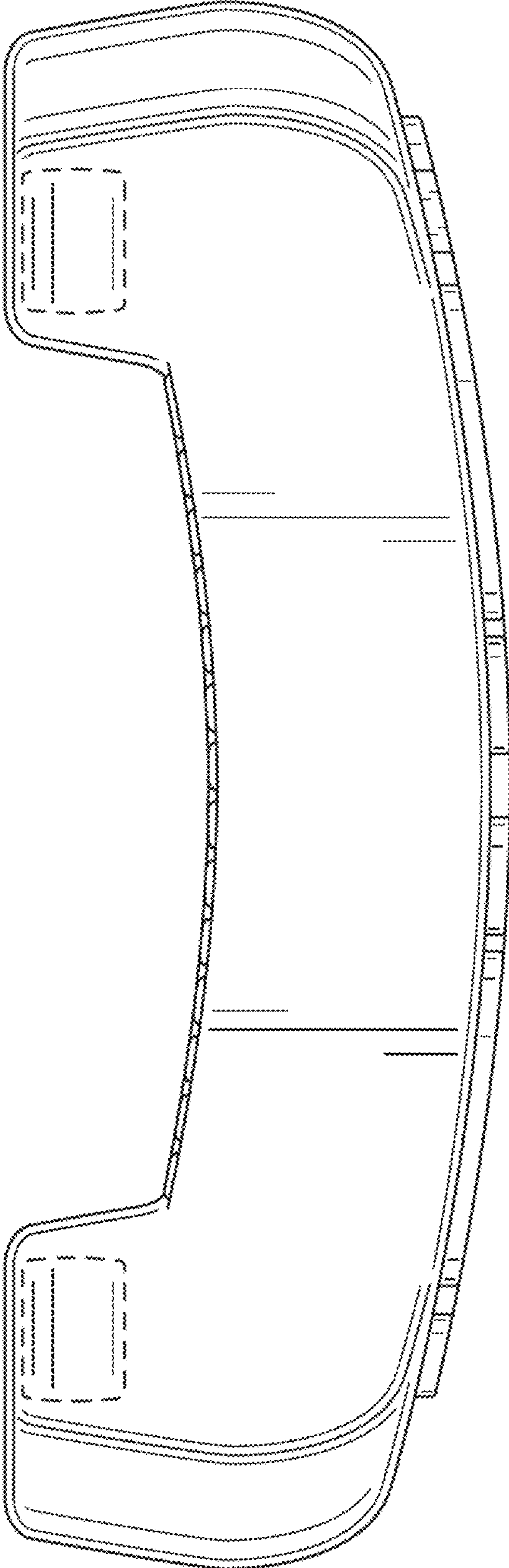

FIG. 44



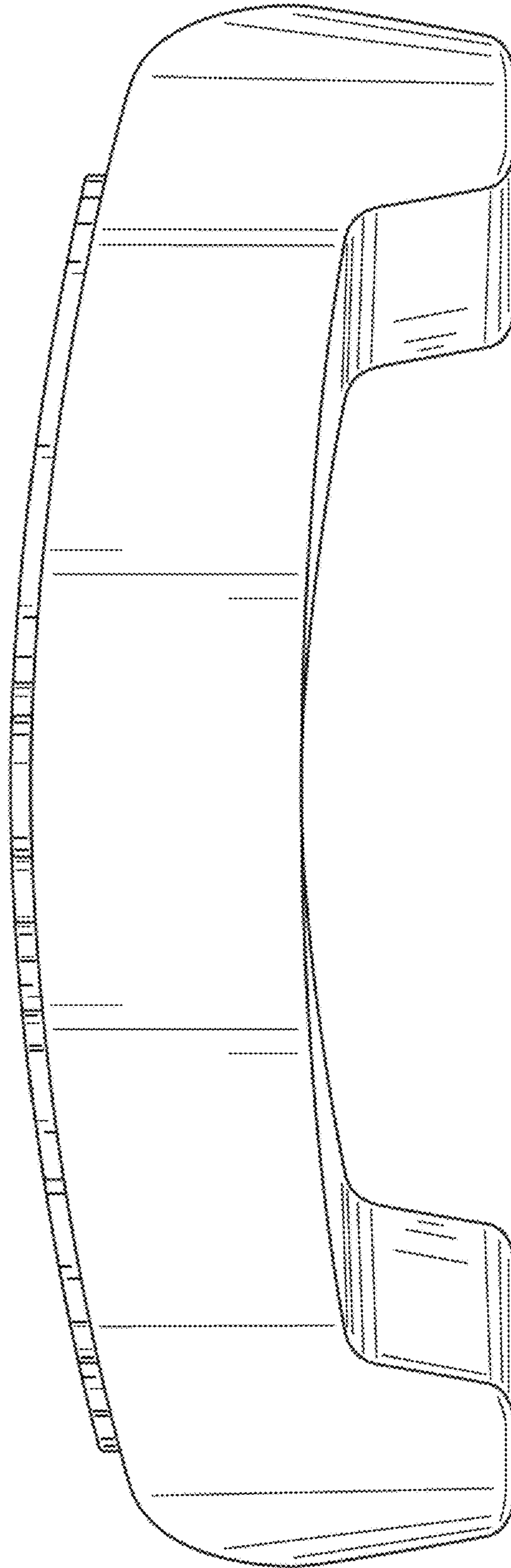

FIG. 45

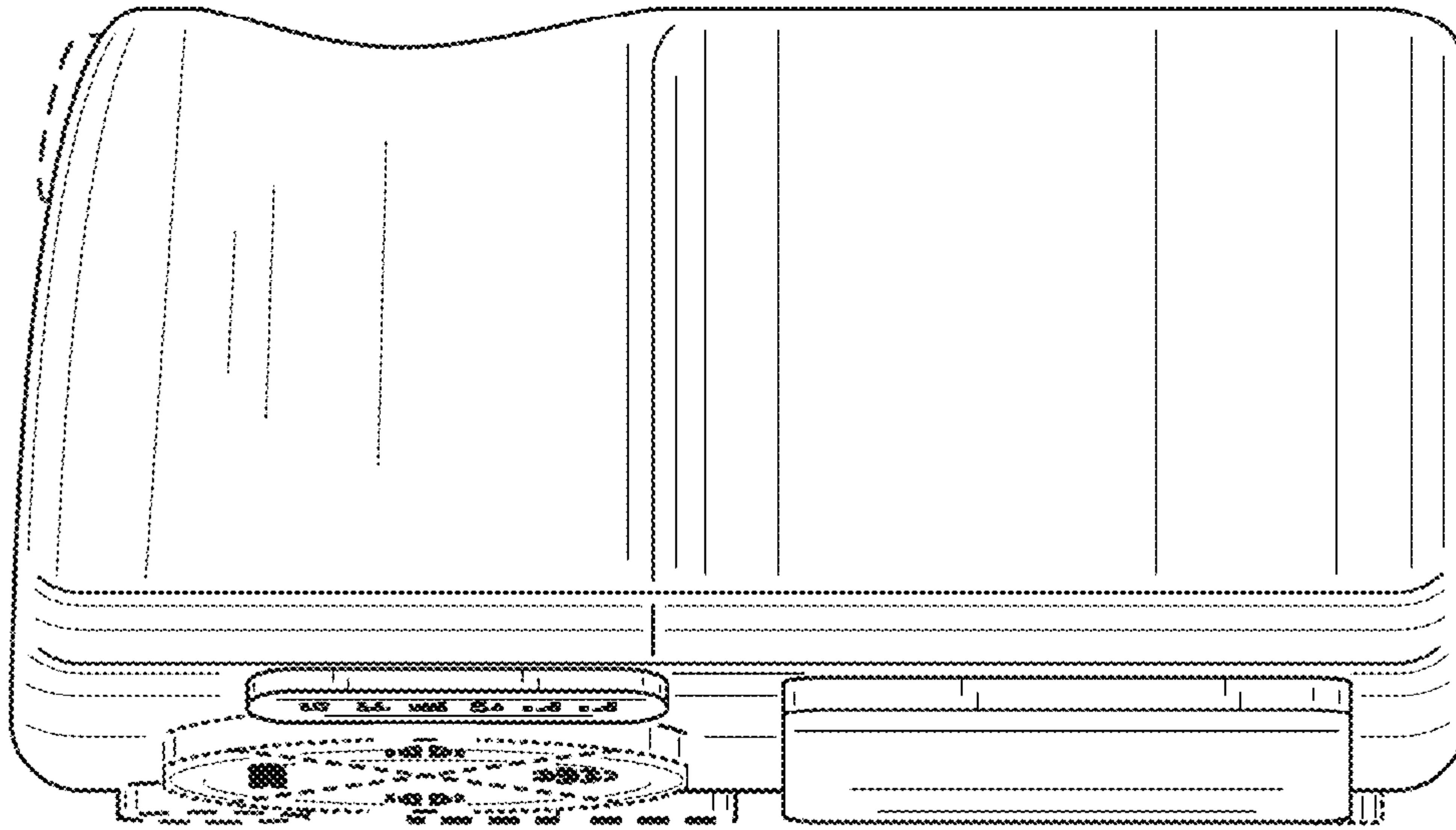

FIG. 46

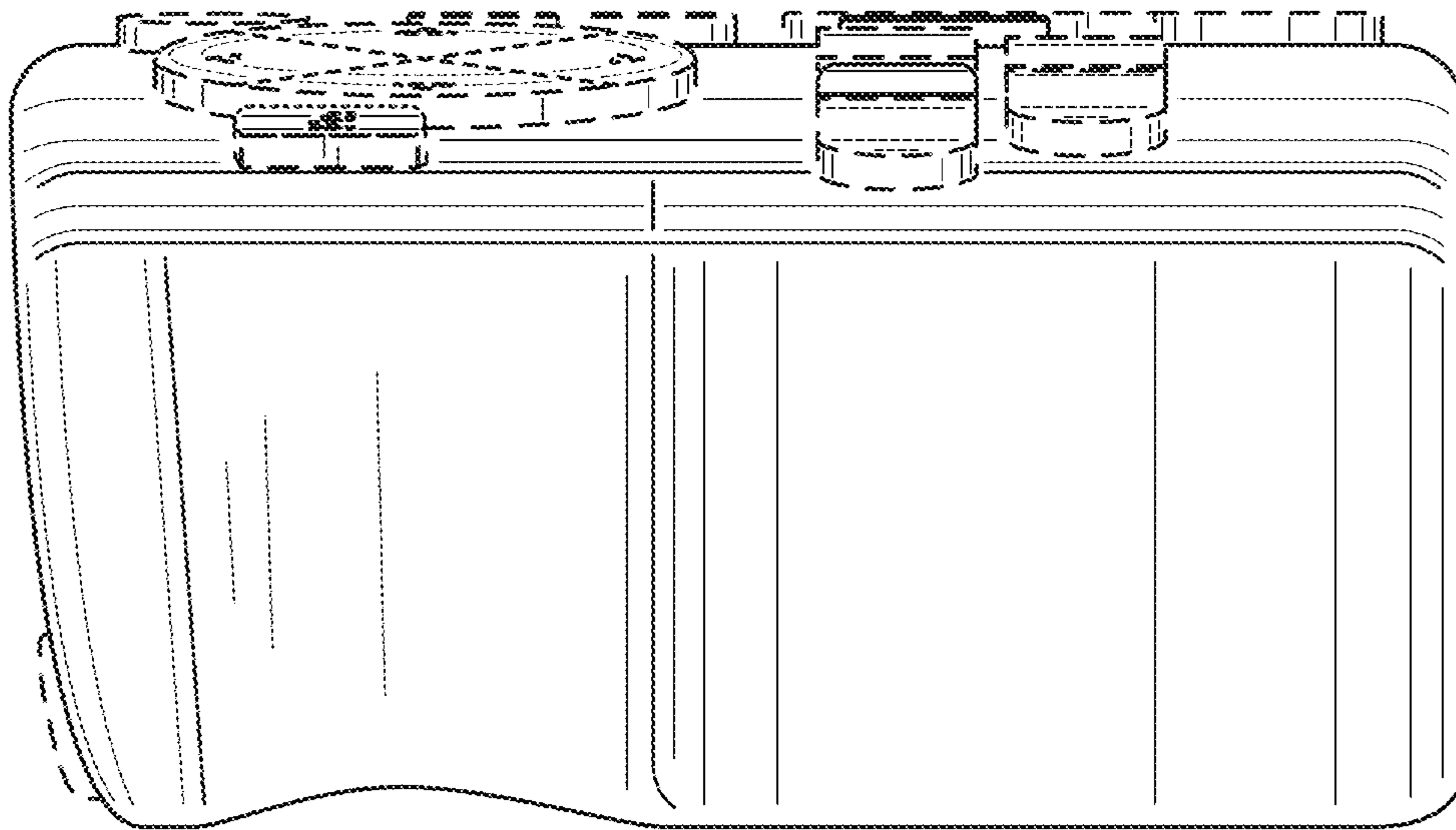

FIG. 47

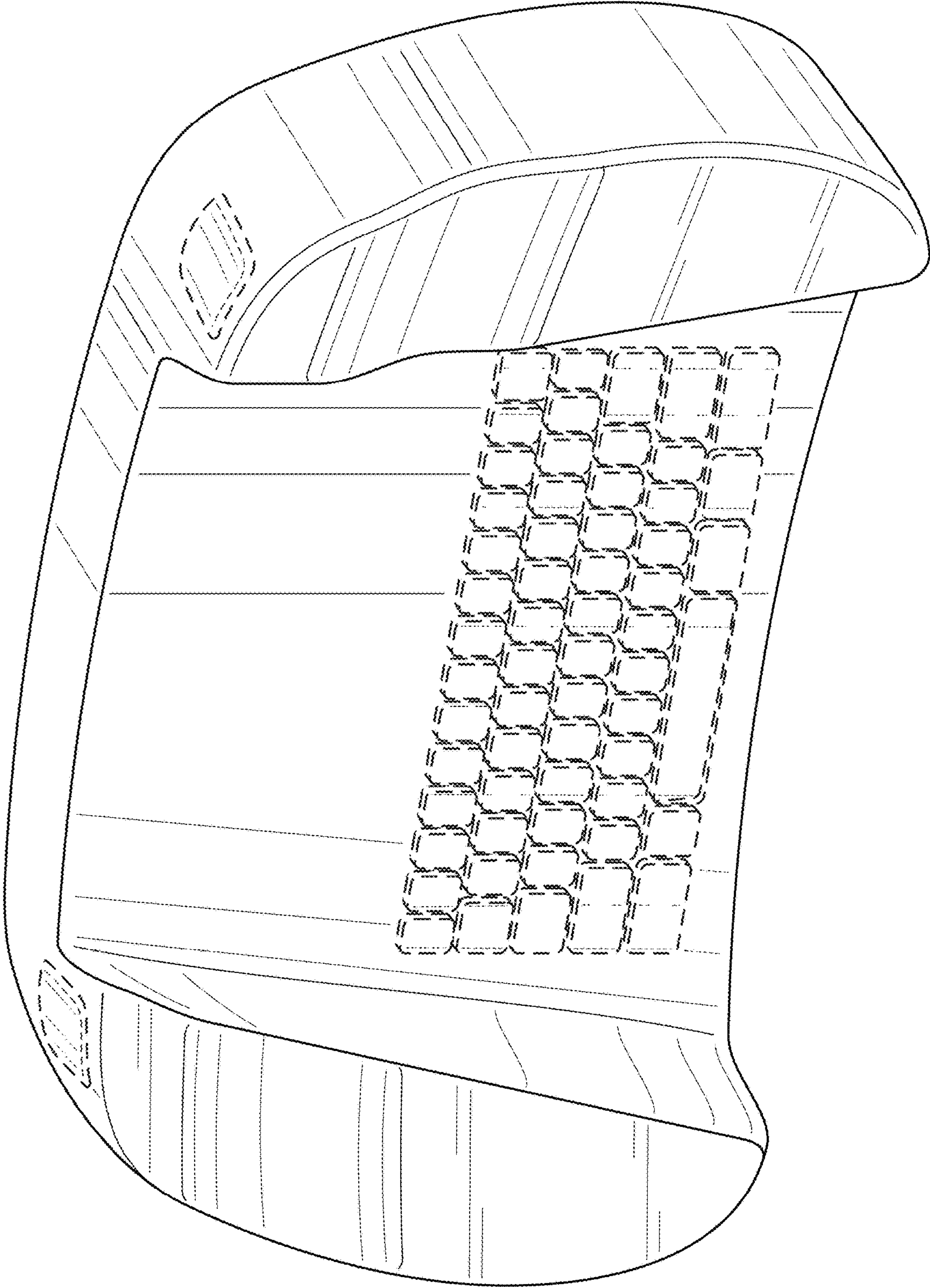

FIG. 48



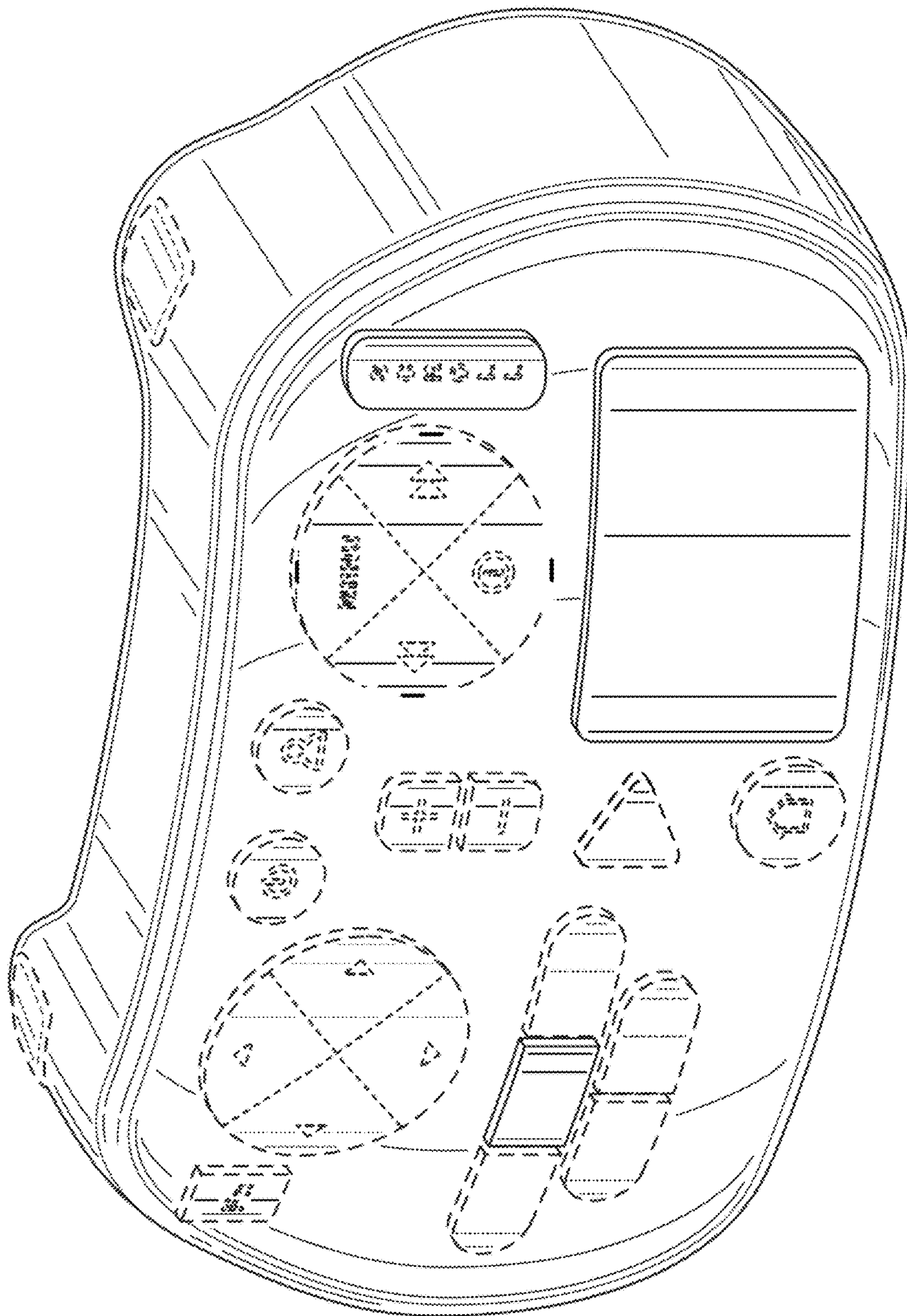

FIG. 49

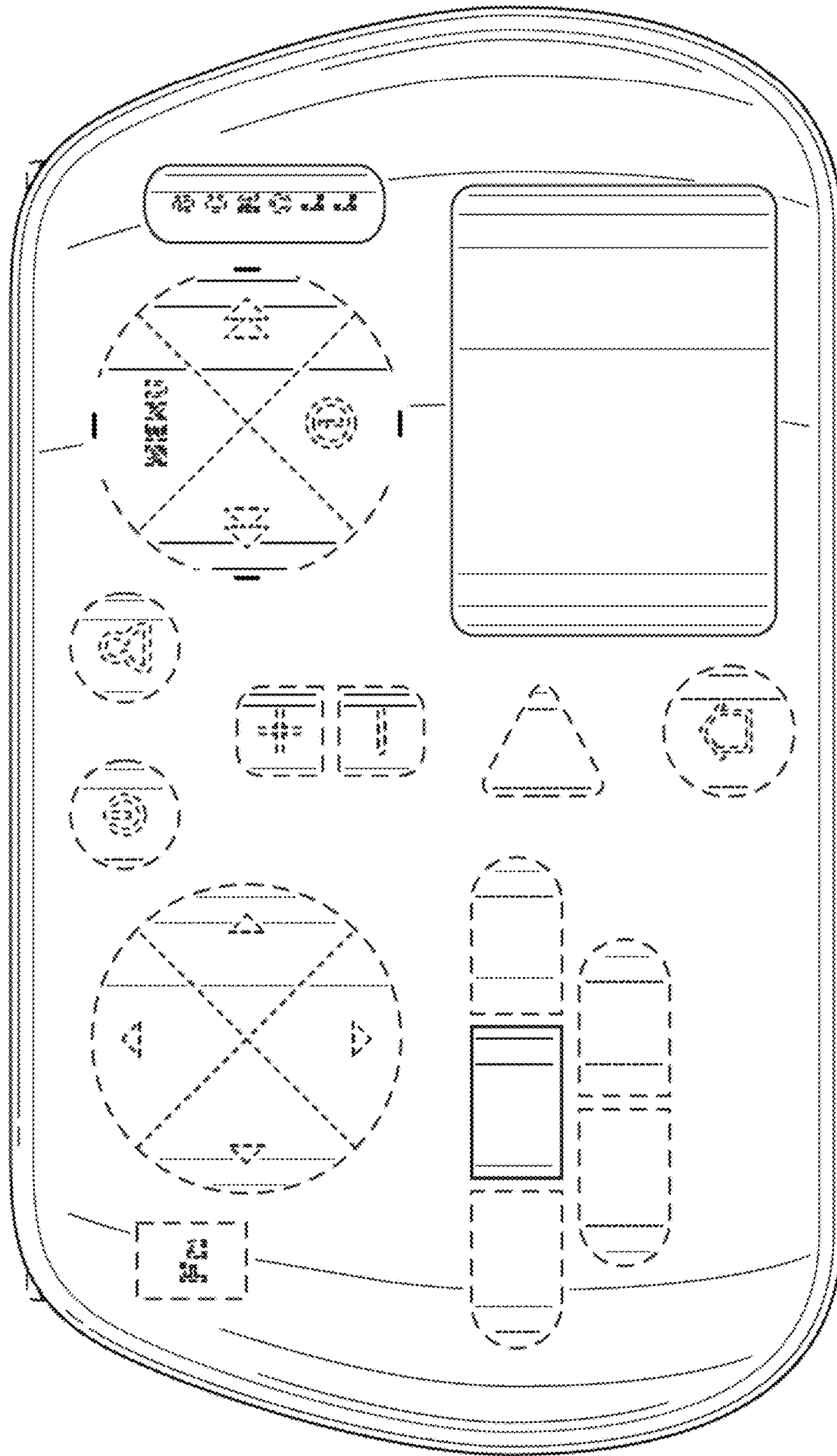

FIG. 50



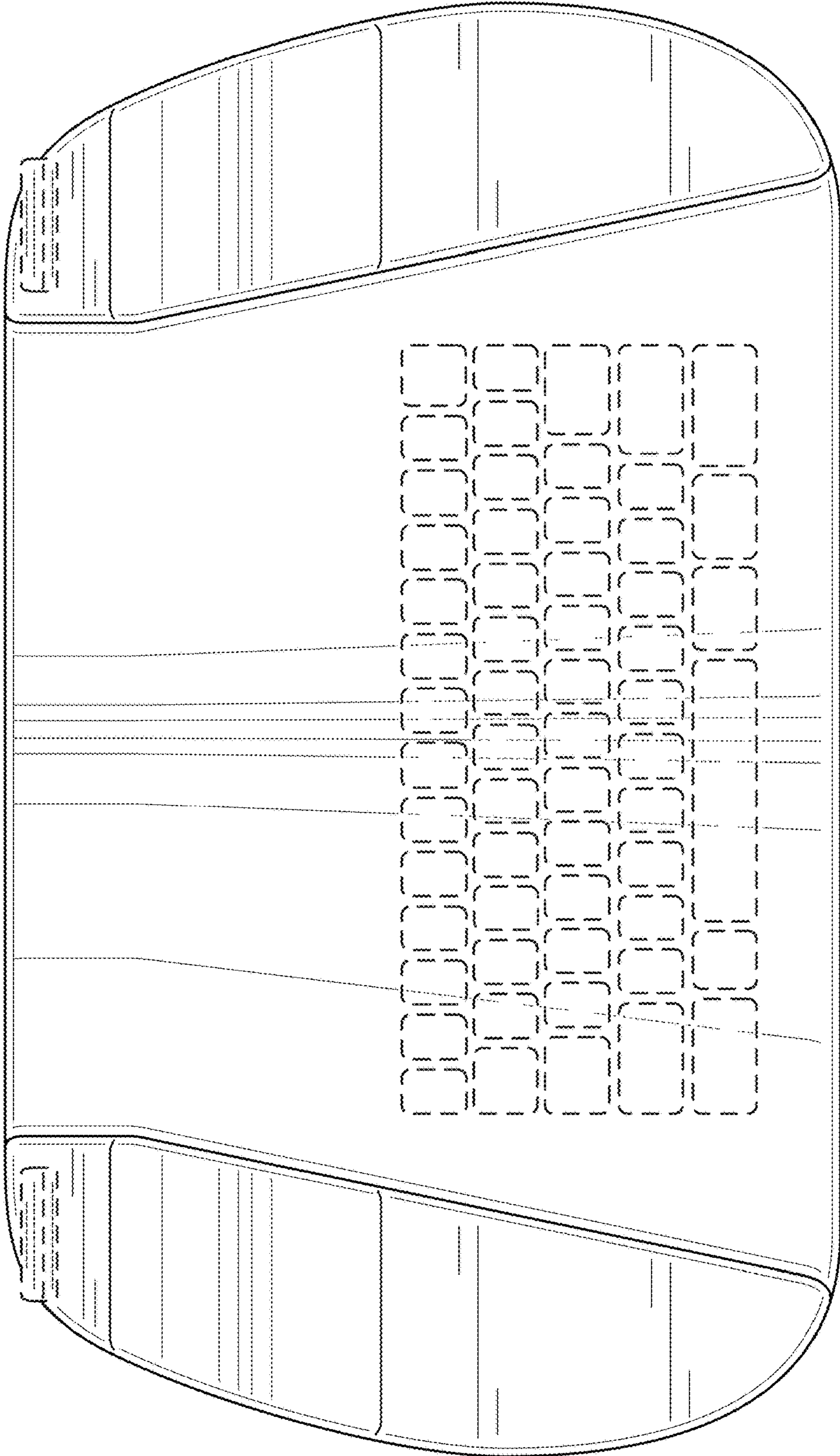

FIG. 51



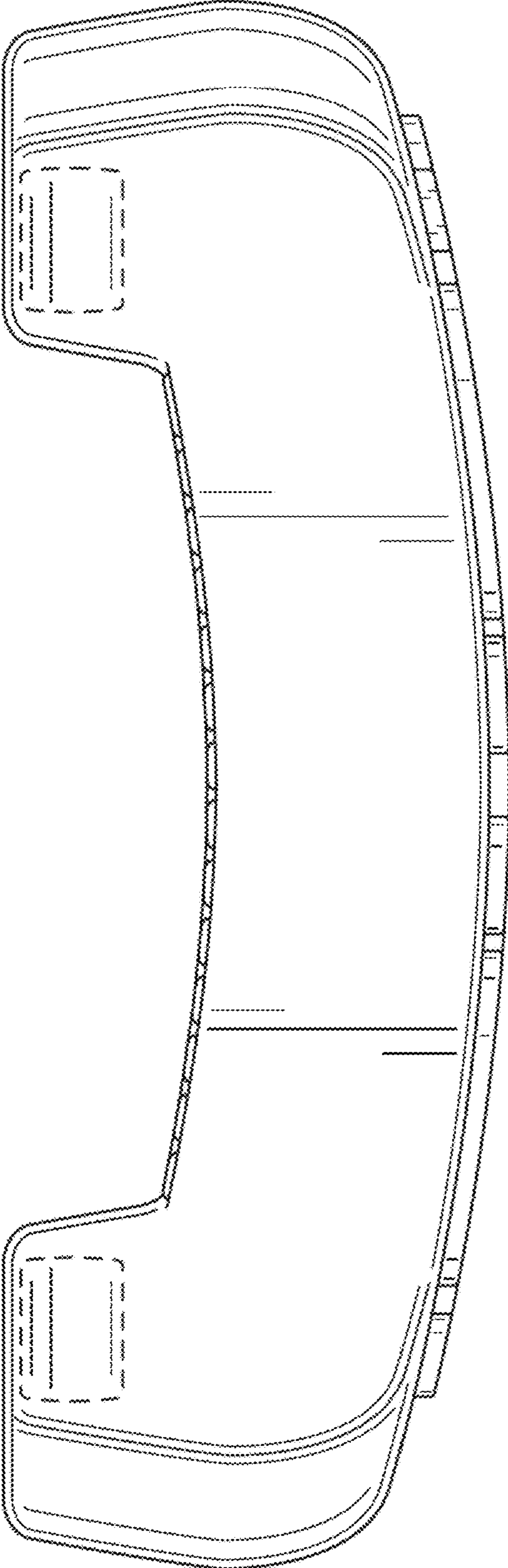

FIG. 52

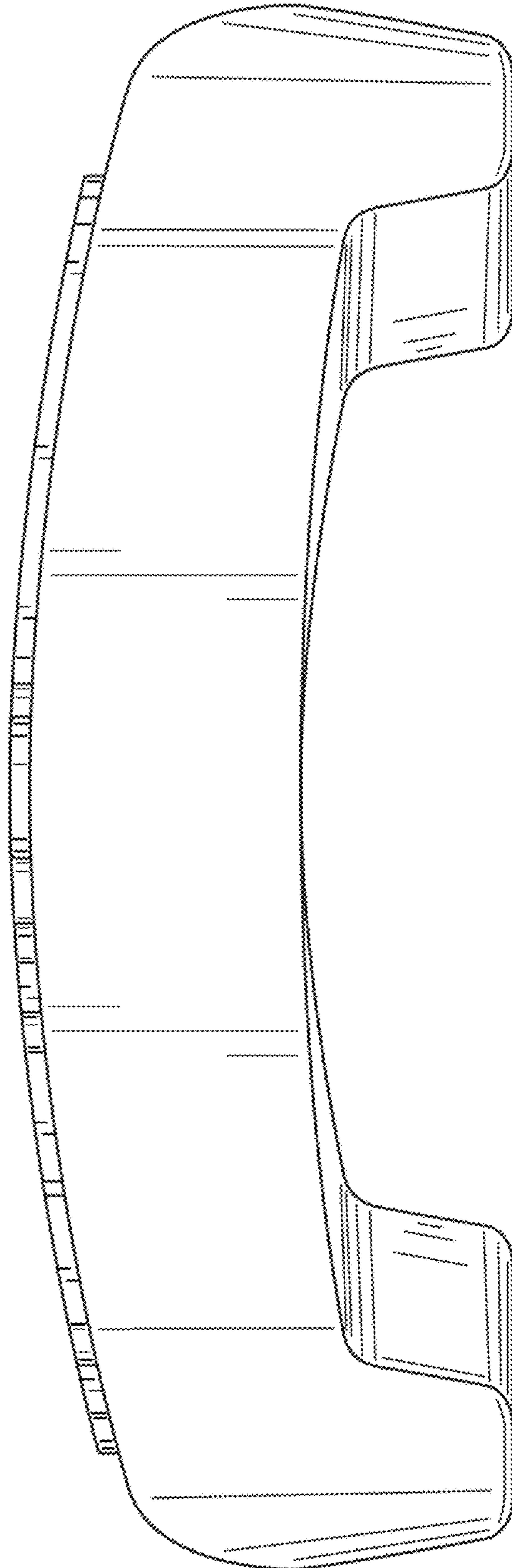

FIG. 53

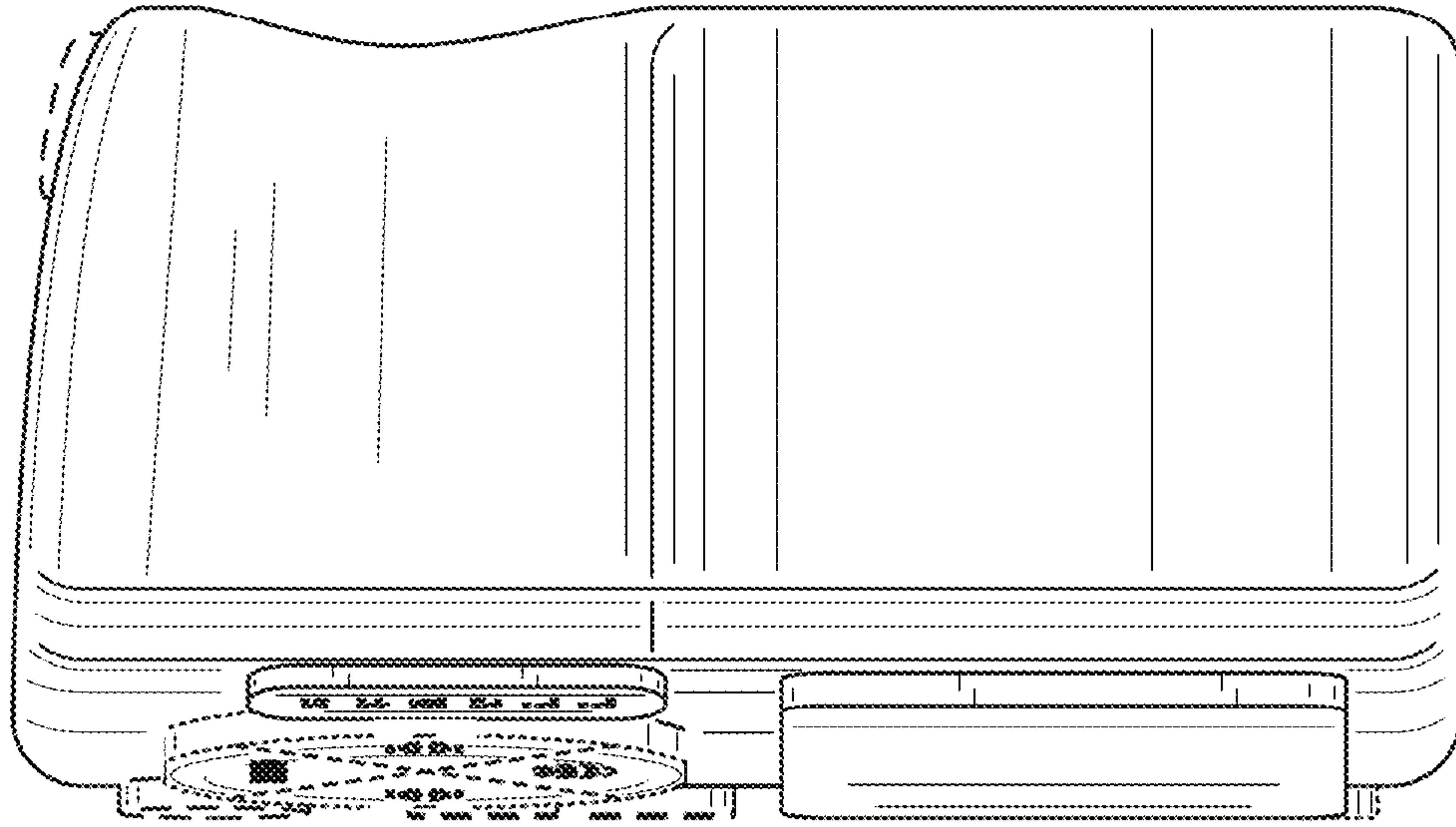

FIG. 54

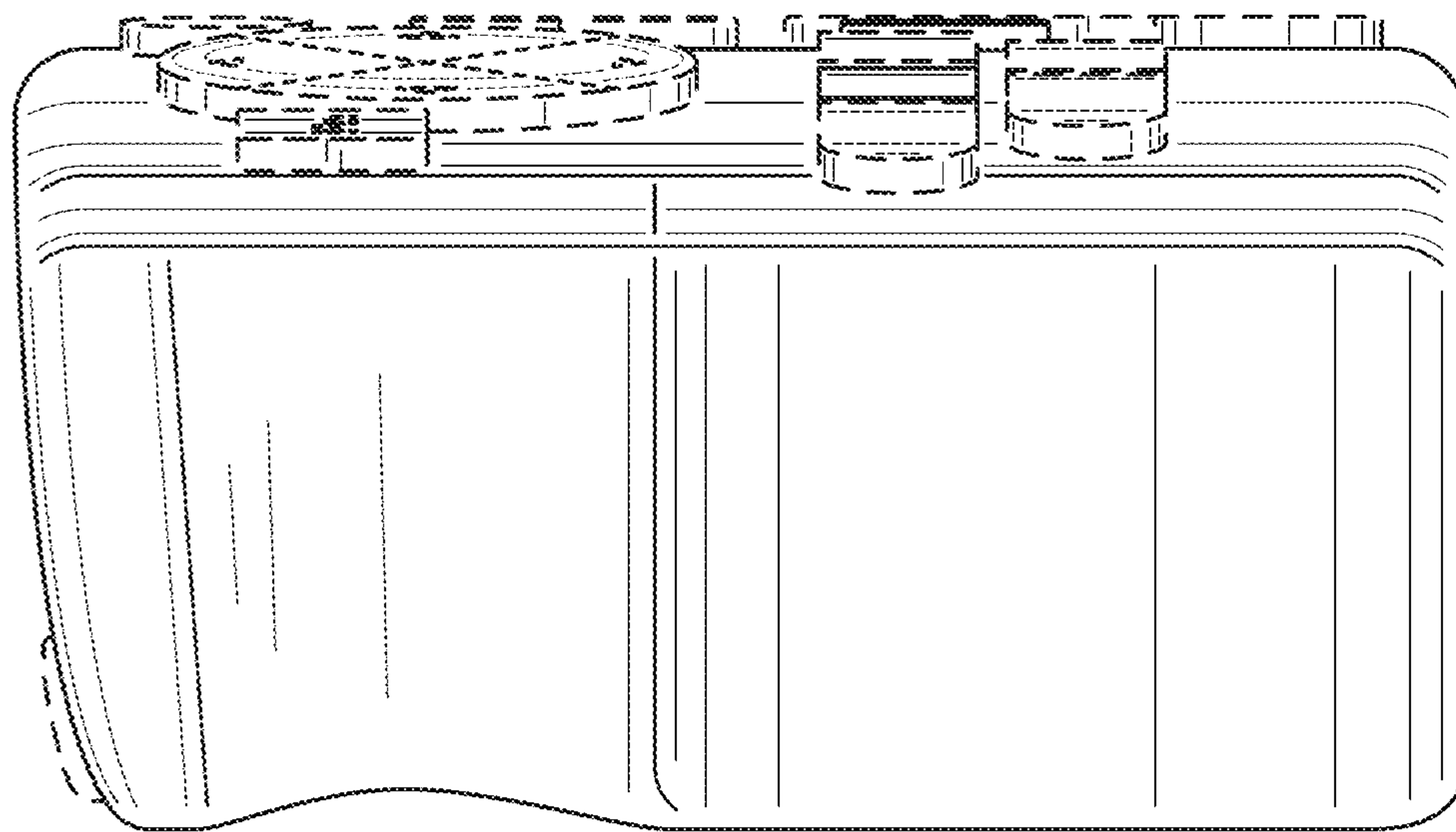

FIG. 55



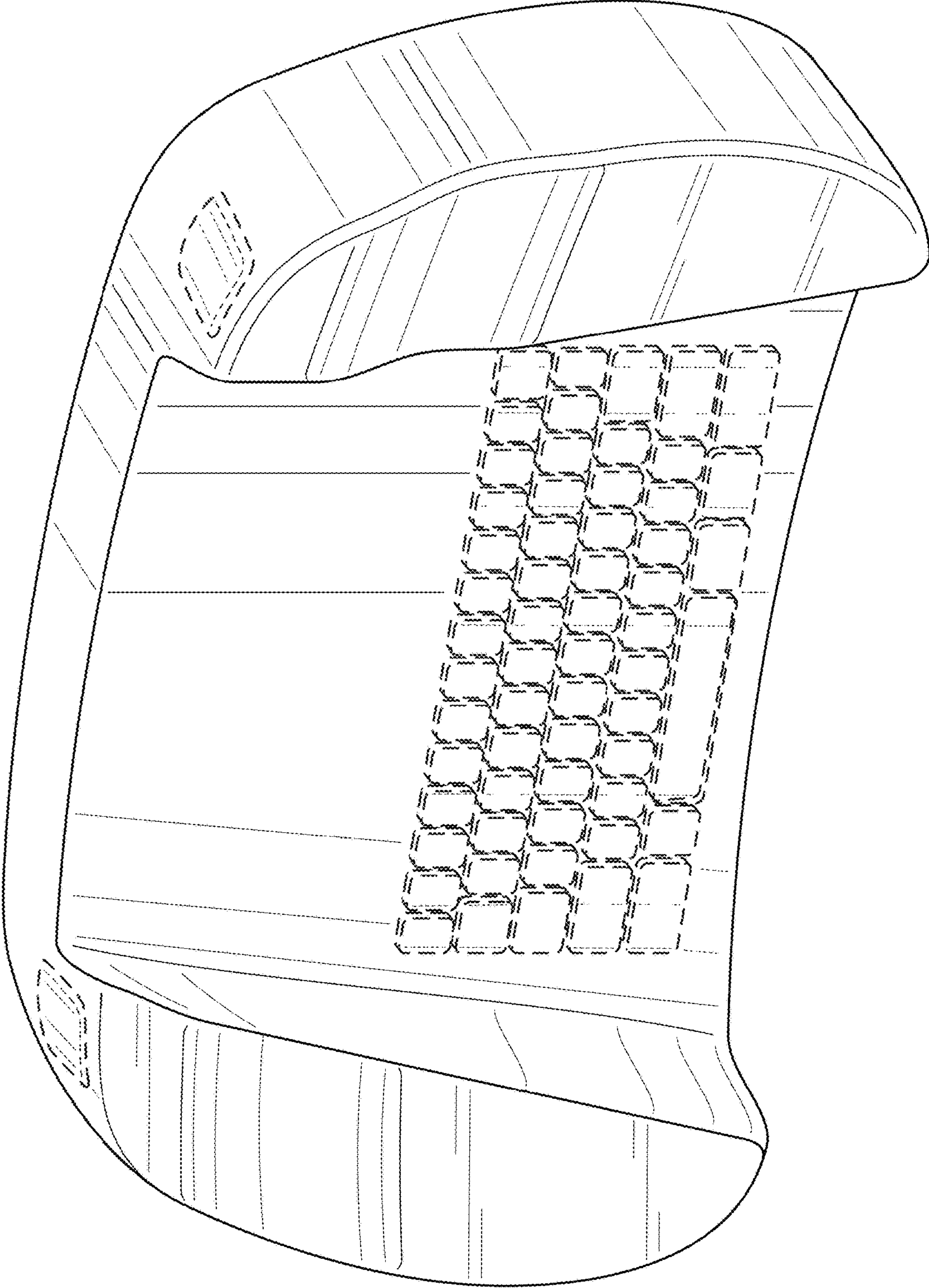

FIG. 56