



US00D833983S

(12) **United States Design Patent** (10) **Patent No.:** **US D833,983 S**  
**Vierjärvi et al.** (45) **Date of Patent:** **\*\* \*Nov. 20, 2018**

(54) **EQUIPMENT FOR CONTROL OF ELECTRIC POWER**

(71) Applicant: **ABB Technology Oy**, Helsinki (FI)

(72) Inventors: **Kari Vierjärvi**, Espoo (FI); **Ville Piironen**, Espoo (FI)

(73) Assignee: **ABB Technology Oy**, Helsinki (FI)

(\*) Notice: This patent is subject to a terminal disclaimer.

(\*\*) Term: **15 Years**

(21) Appl. No.: **29/597,961**

(22) Filed: **Mar. 21, 2017**

(30) **Foreign Application Priority Data**

Sep. 23, 2016 (EP) ..... 003391085

(51) **LOC (11) Cl.** ..... **13-03**

(52) **U.S. Cl.**  
USPC ..... **D13/163; D13/184**

(58) **Field of Classification Search**  
USPC ..... D13/158, 162, 163, 184  
CPC ... H02B 1/01; H02B 1/26; H02B 1/30; H05K 5/00; H05K 5/0004; H05K 5/0008; H05K 5/0017; H05K 5/03; H05K 5/04  
See application file for complete search history.

(56) **References Cited**

**U.S. PATENT DOCUMENTS**

D193,301 S \* 7/1962 Brokaw ..... D13/163  
D210,078 S \* 2/1968 Sachs ..... D13/163  
D349,888 S \* 8/1994 Yamamoto ..... D13/163  
D365,086 S \* 12/1995 Spechts ..... D13/184  
5,822,180 A \* 10/1998 Deschamps ..... H02B 1/015  
361/627  
D503,931 S \* 4/2005 Kauranen ..... D13/184

D512,696 S \* 12/2005 Nurmi ..... D13/162  
D521,466 S \* 5/2006 Nurmi ..... D13/184  
D543,161 S \* 5/2007 Stepputat ..... D13/184  
D588,081 S \* 3/2009 Lewis, II ..... D13/184  
7,952,042 B2 \* 5/2011 Coomer ..... H02B 11/02  
200/293  
D653,224 S \* 1/2012 Jonas ..... D13/184  
2014/0104759 A1 \* 4/2014 Takano ..... H05K 7/1432  
361/637  
2015/0173253 A1 \* 6/2015 Lewis, II ..... H05K 5/0004  
312/223.2  
2016/0219729 A1 \* 7/2016 Omari ..... H02B 1/26  
2016/0255421 A1 \* 9/2016 Farrar ..... H04Q 9/00  
340/870.07  
2016/0372896 A1 \* 12/2016 Strong ..... H02B 1/06  
2017/0077831 A1 \* 3/2017 Yanagimoto ..... H05K 7/1432

(Continued)

*Primary Examiner* — Selina Sikder

(74) *Attorney, Agent, or Firm* — Taft Stettinius & Hollister LLP

(57) **CLAIM**

The ornamental design for equipment for control of electric power, as shown and described.

**DESCRIPTION**

FIG. 1 is a perspective side view of equipment for control of electric power.

FIG. 2 is a front side view of the equipment shown in FIG. 1.

FIG. 3 is a back side view of the equipment shown in FIG. 1.

FIG. 4 is a right side view of the equipment shown in FIG. 1.

FIG. 5 is a left side view of the equipment shown in FIG. 1.

FIG. 6 is a top side view of the equipment shown in FIG. 1; and,

FIG. 7 is a bottom side view of the equipment shown in FIG. 1 wherein the broken lines are shown for illustrative purposes only and forms no part of the claimed design.

**1 Claim, 7 Drawing Sheets**

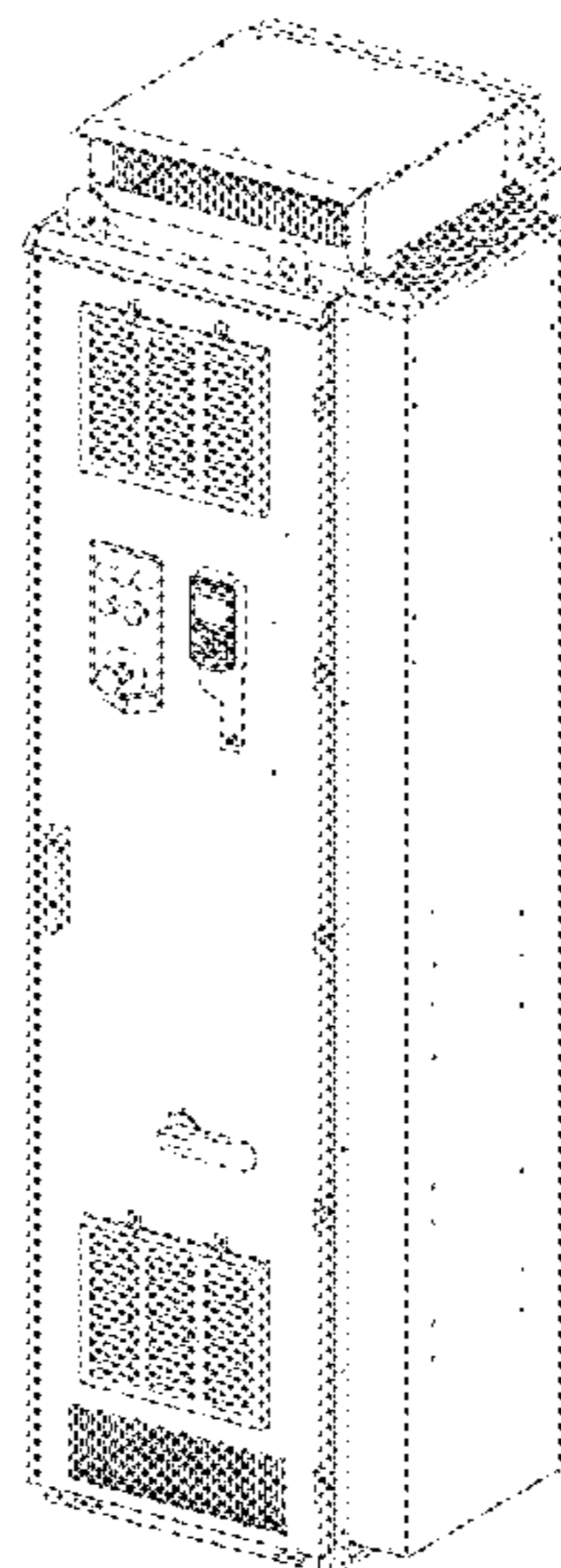

(56)

**References Cited**

U.S. PATENT DOCUMENTS

2017/0150636 A1\* 5/2017 Segroves ..... H05K 7/1489  
2017/0172015 A1\* 6/2017 Yu ..... H05K 7/20909

\* cited by examiner

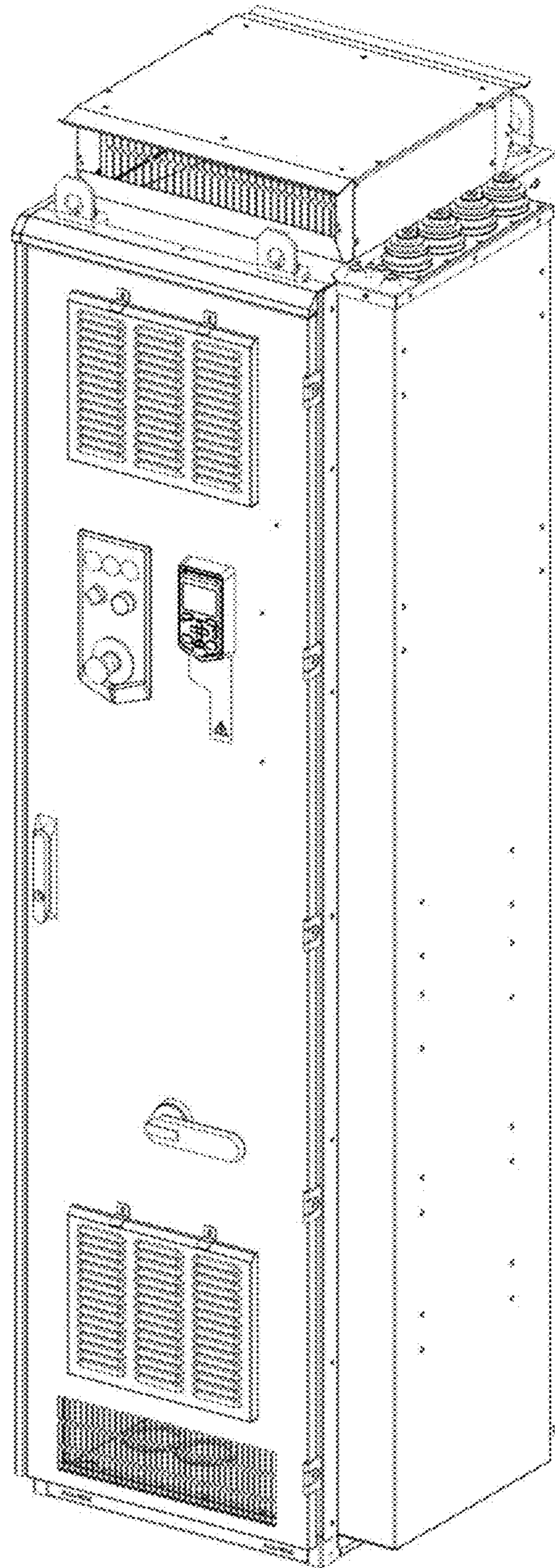

FIGURE 1

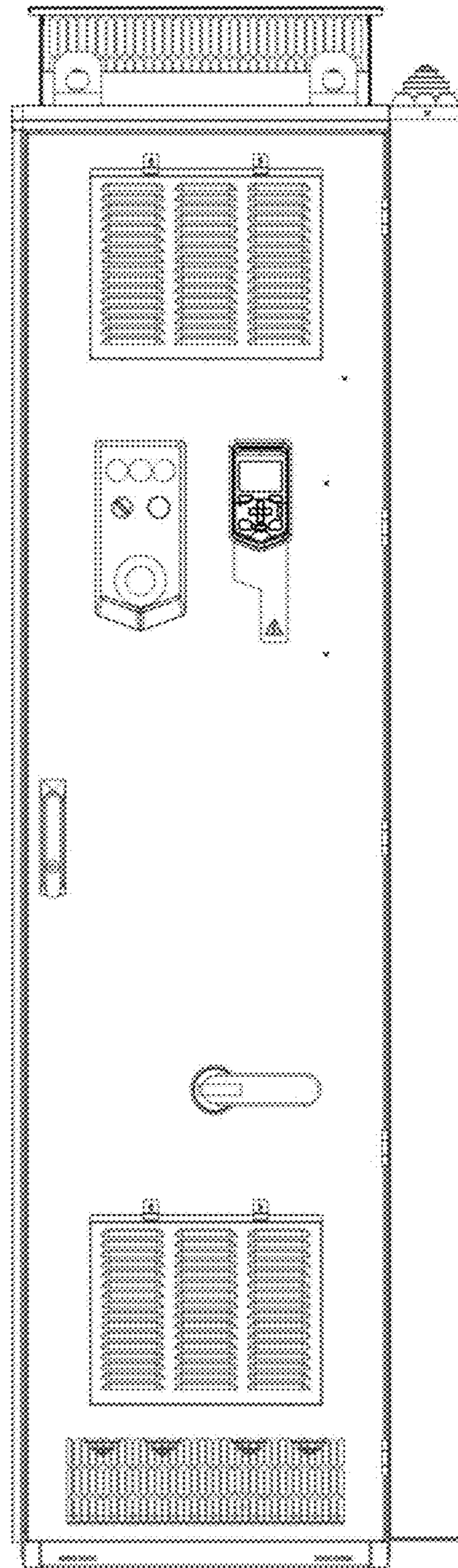

FIGURE 2

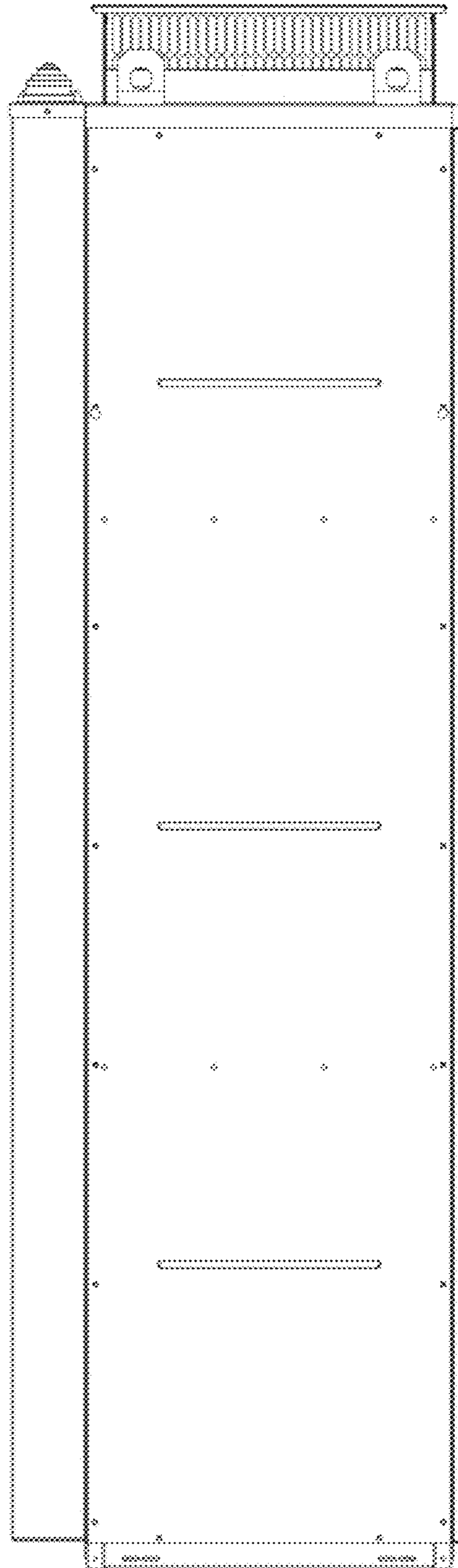

FIGURE 3

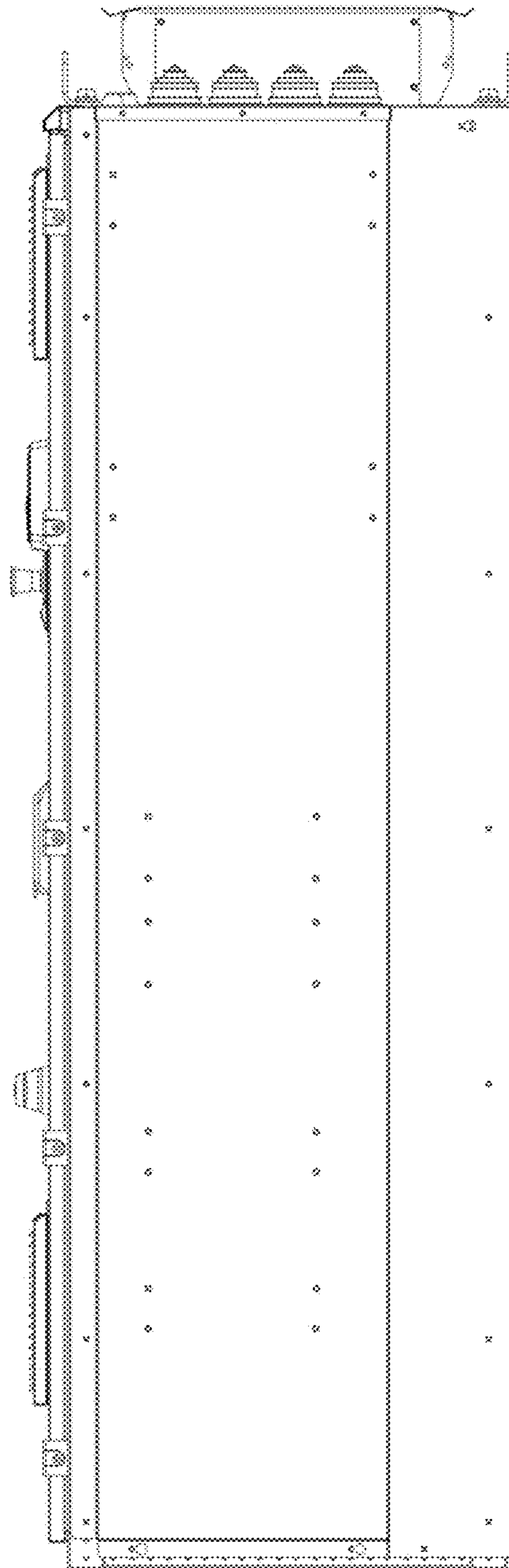

FIGURE 4

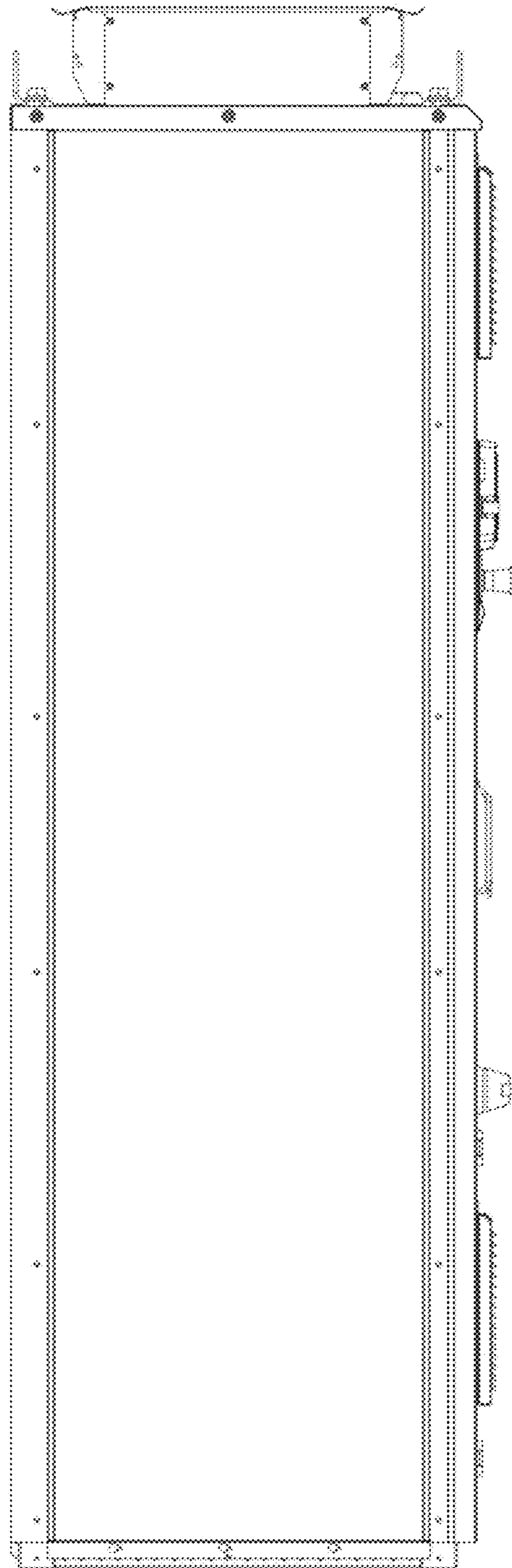

FIGURE 5

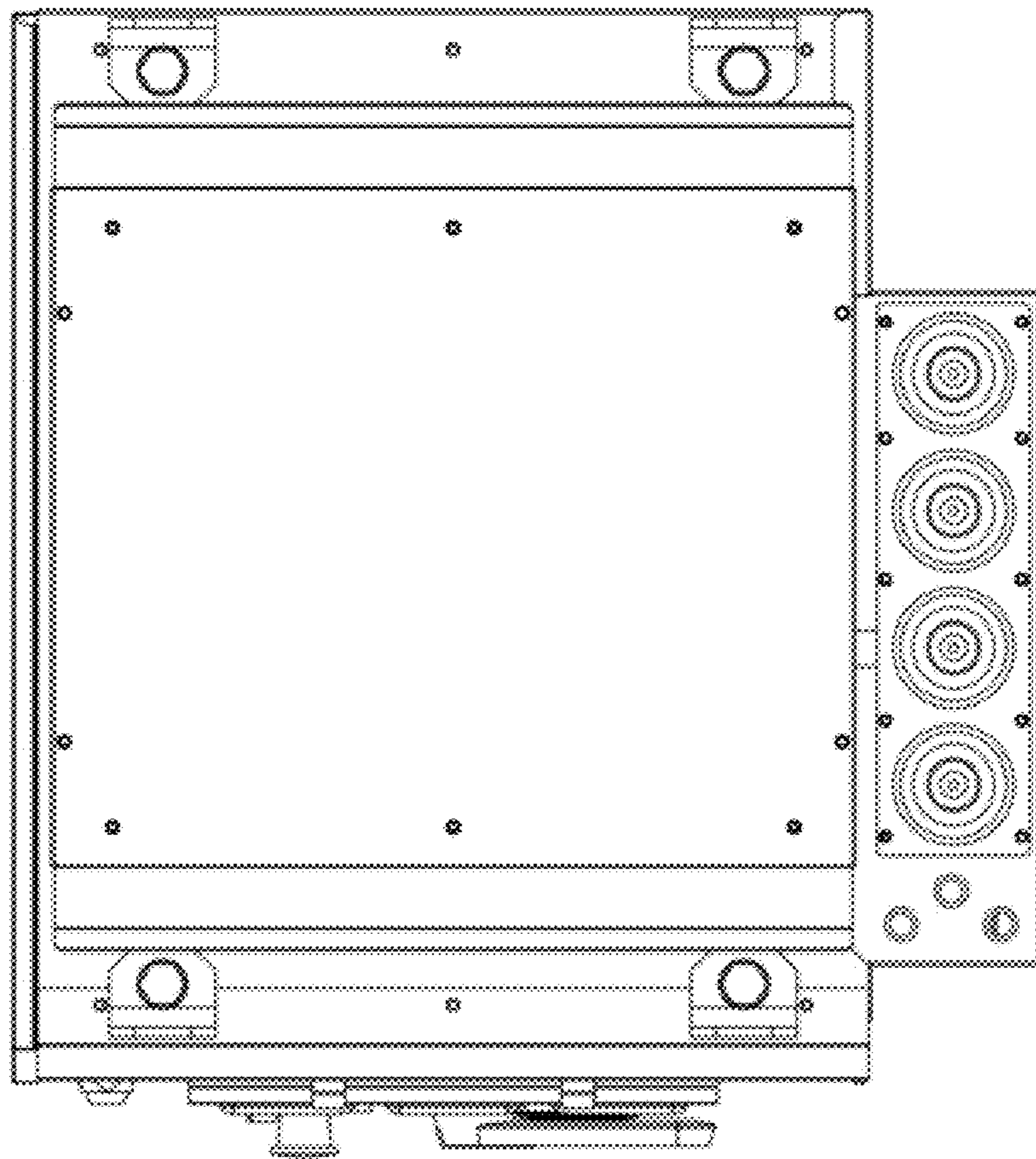

FIGURE 6



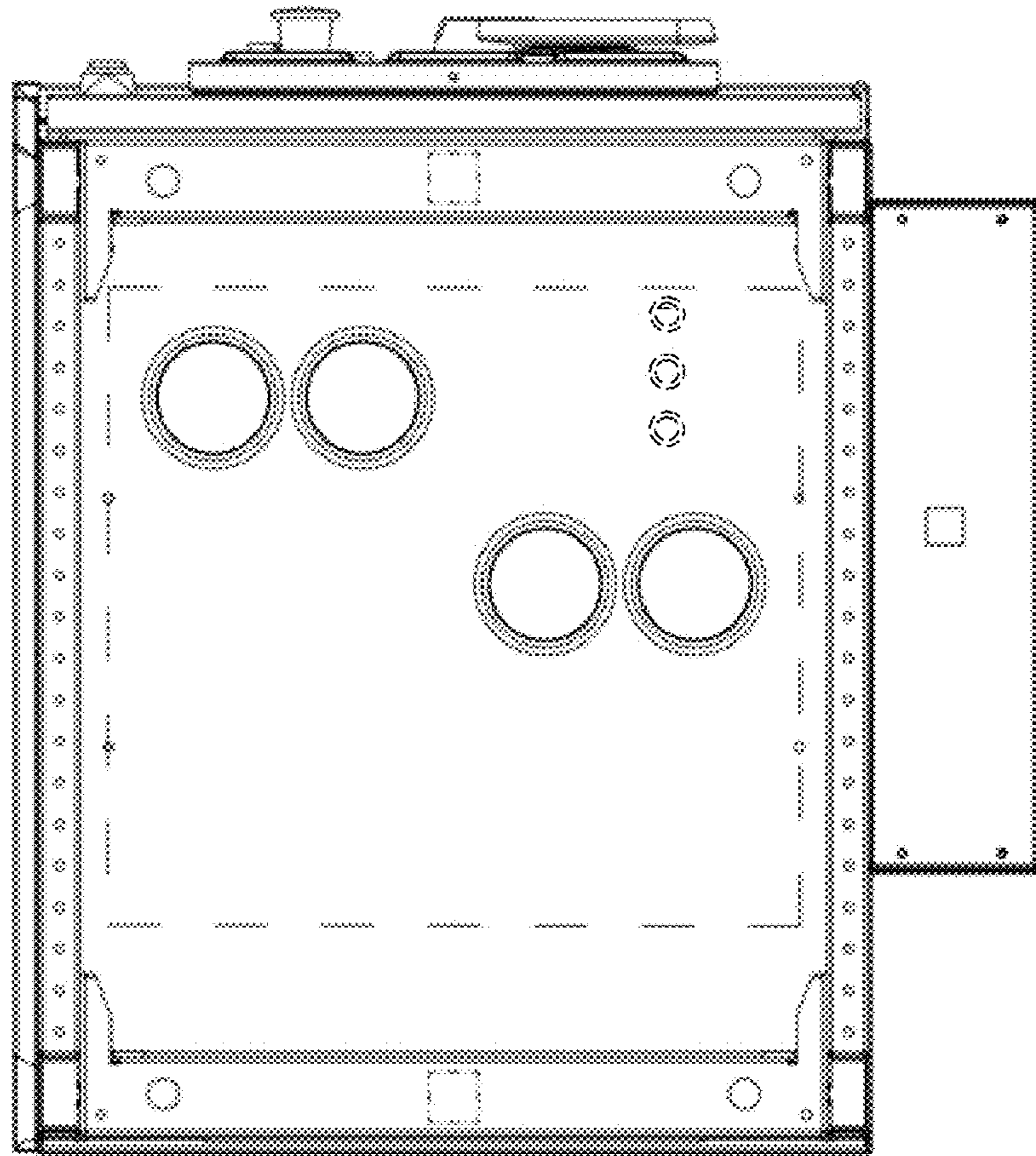

FIGURE 7