



US00D833936S

(12) **United States Design Patent** (10) **Patent No.:** **US D833,936 S**
Akrapovic et al. (45) **Date of Patent:** **** Nov. 20, 2018**

(54) **EXHAUST PIPE**

(56) **References Cited**

(71) Applicant: **Igor Akrapovic**, Ljubljana (SI)
(72) Inventors: **Igor Akrapovic**, Ljubljana (SI);
Andraz Kranjc, Loka Pri Zidanem
Mostu (SI); **Marko Besal**, Smarjeske
Toplice (SI); **Boris Stanic**, Koper (SI)

U.S. PATENT DOCUMENTS

D550,134 S *	9/2007	Akrapovic	D12/194
D573,520 S *	7/2008	Kouchi	D12/194
D589,422 S *	3/2009	Davis, Jr.	D12/194
D803,744 S *	11/2017	Akrapovic	D12/194
D804,381 S *	12/2017	Akrapovic	F01N 13/20
				D12/194
D804,382 S *	12/2017	Akrapovic	F01N 1/10
				D12/194
2004/0089500 A1 *	5/2004	Lewis	F01N 1/10
				181/249
2008/0121456 A1 *	5/2008	Davis	F01N 13/20
				180/309

(**) Term: **15 Years**
(21) Appl. No.: **35/503,954**
(22) Filed: **Aug. 2, 2017**

* cited by examiner

(80) **Hague Agreement Data**

Int. Filing Date: **Aug. 2, 2017**
Int. Reg. No.: **DM/098327**
Int. Reg. Date: **Aug. 2, 2017**
Int. Reg. Pub. Date: **Nov. 17, 2017**

Primary Examiner — George D. Kirschbaum
Assistant Examiner — Joseph J Kukella
(74) *Attorney, Agent, or Firm* — Olson & Cepuritis, Ltd.;
William P. Oberhardt; Anita M. Cepuritis

(57) **CLAIM**

The ornamental design for an exhaust pipe, as shown and described.

(30) **Foreign Application Priority Data**

Feb. 10, 2017 (EM) 003747450

(51) **LOC (11) Cl.** **12-16**

(52) **U.S. Cl.**
USPC **D12/194**

(58) **Field of Classification Search**
USPC D23/205, 209, 323, 330; D12/194;
D15/5
CPC F01N 13/08; F01N 13/082; F01N 13/085;
F01N 13/087; F01N 1/00; F01N 1/003;
F01N 1/02; F01N 1/04; F01N 1/10; F01N
1/24

See application file for complete search history.

DESCRIPTION

- 1. Exhaust pipe
- 1.1 : Perspective
- 1.2 : Right
- 1.3 : Left
- 1.4 : Bottom
- 1.5 : Top
- 1.6 : Front
- 1.7 : Back
- 1.8 : Perspective
- 1.9 : Perspective

1 Claim, 9 Drawing Sheets

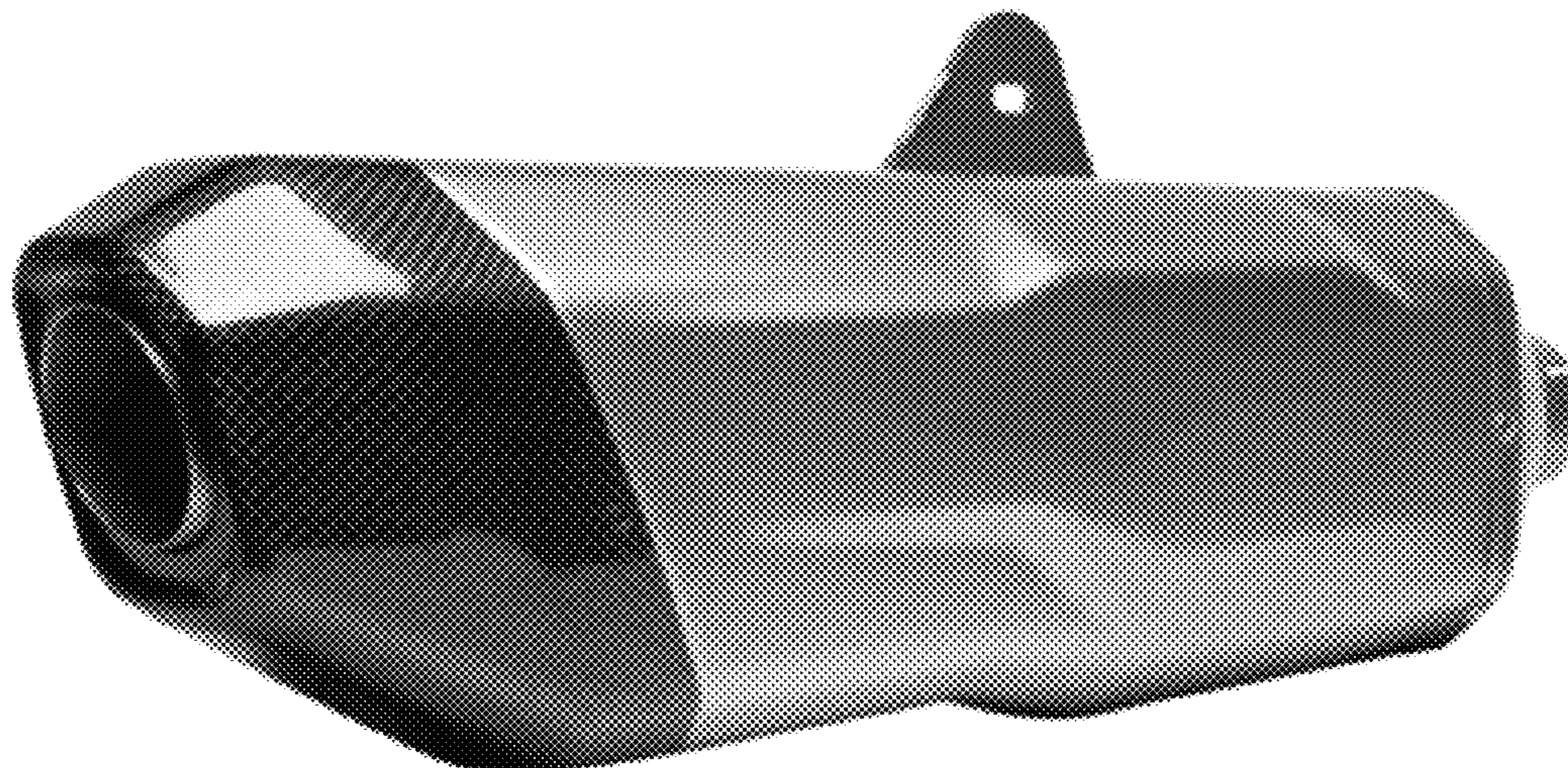

1.1

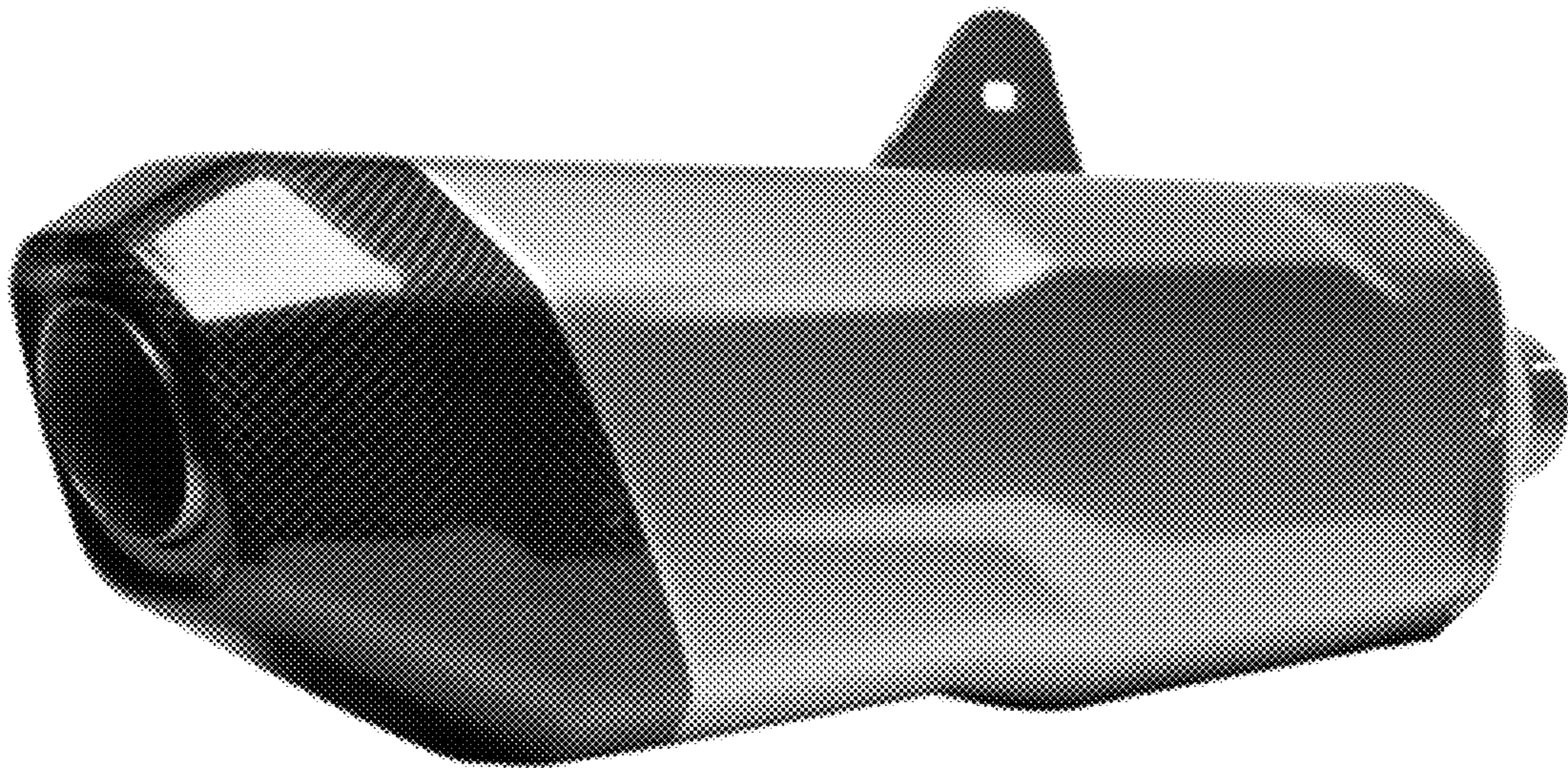

1.2

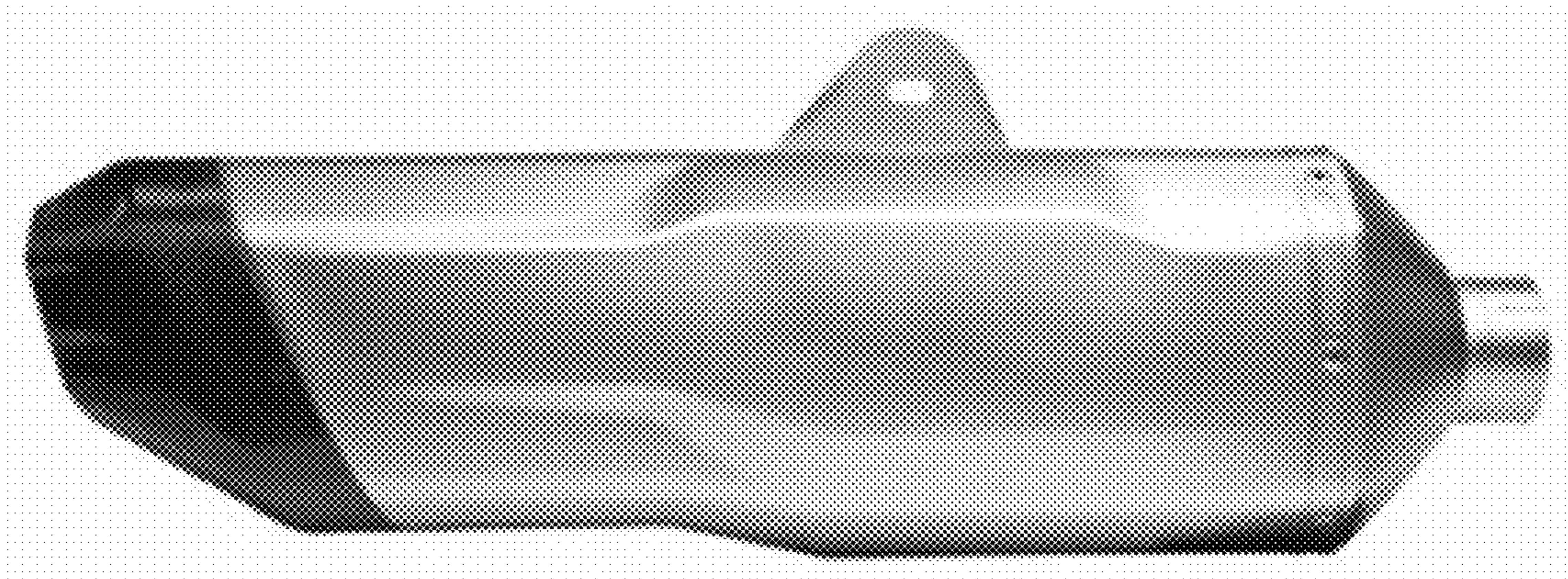

1.3

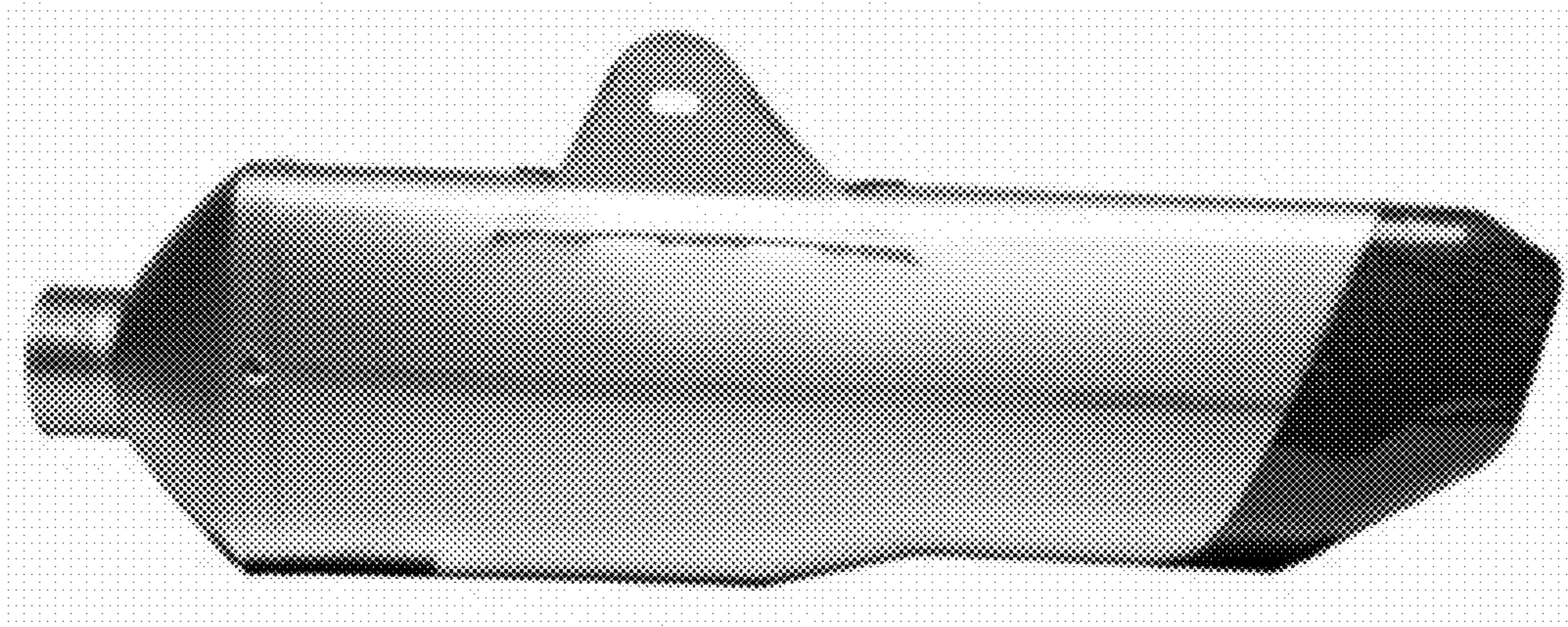

1.4

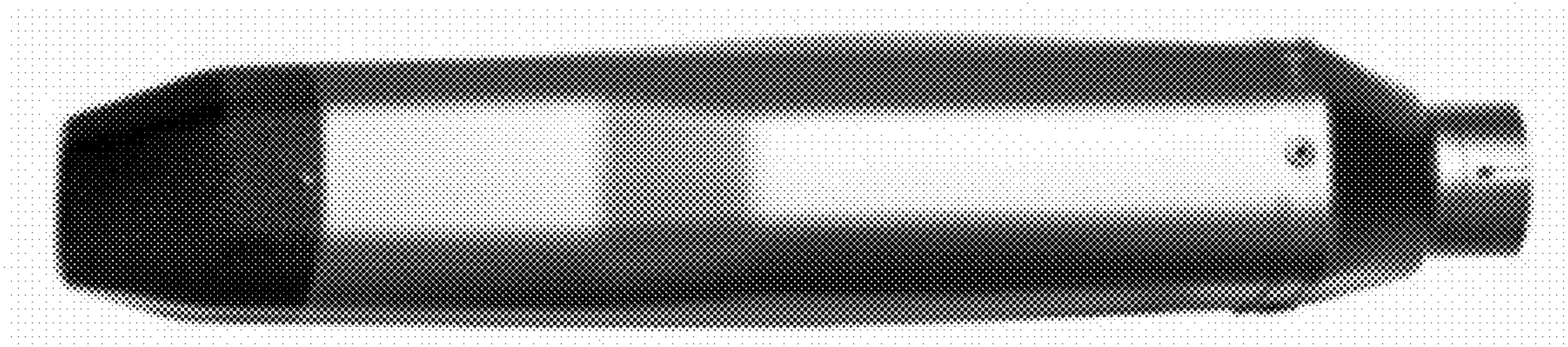

1.5

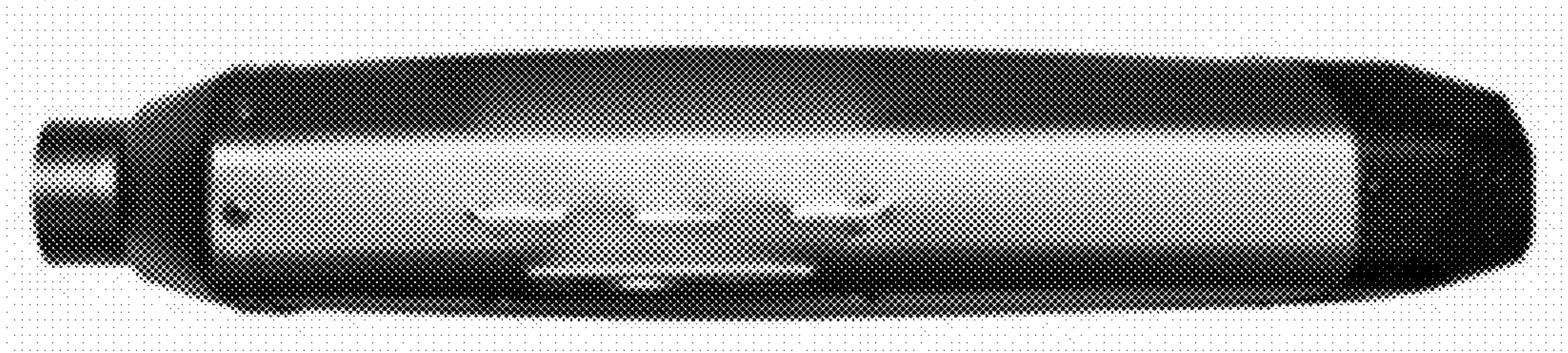

1.6

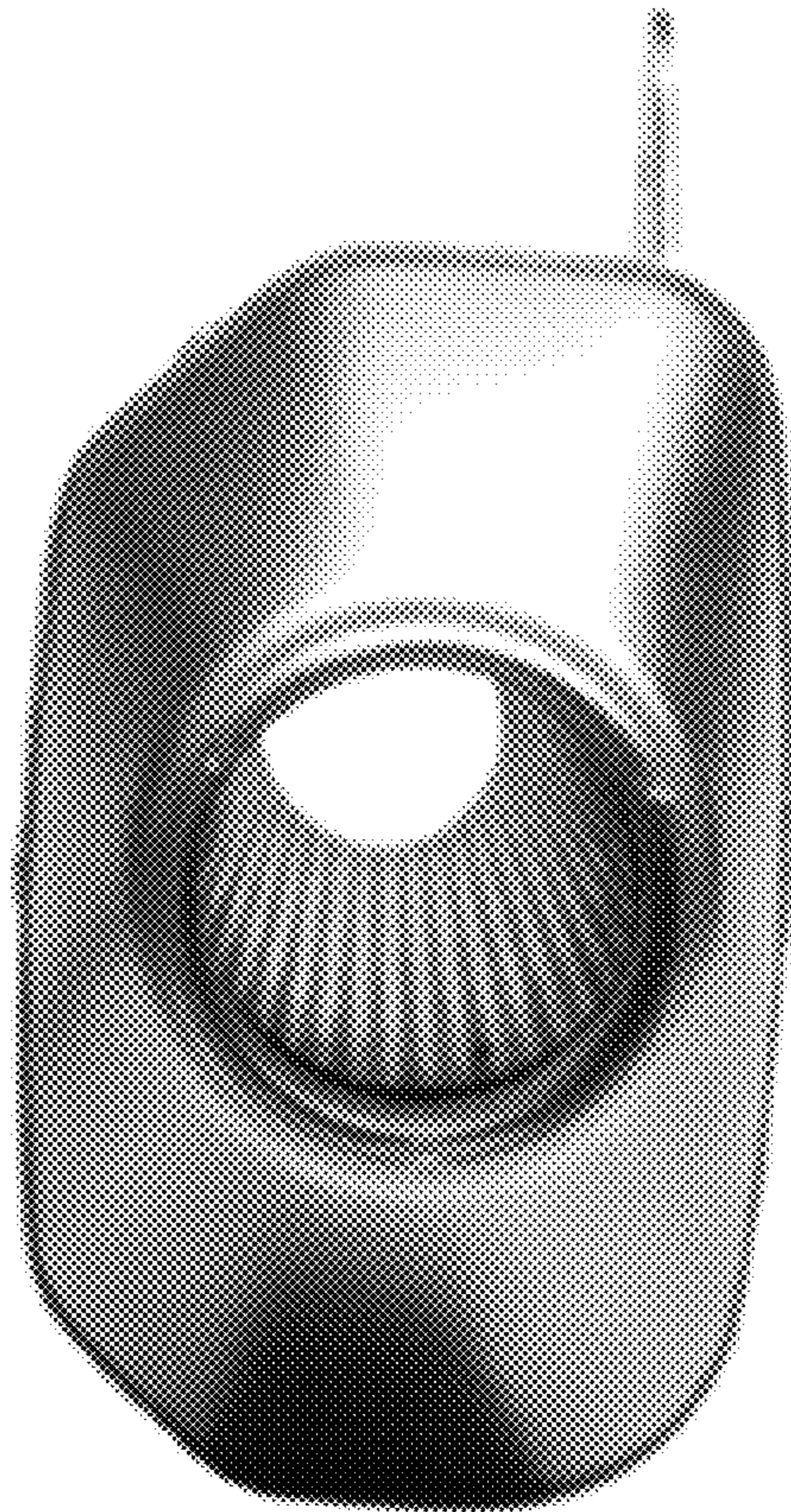

1.7

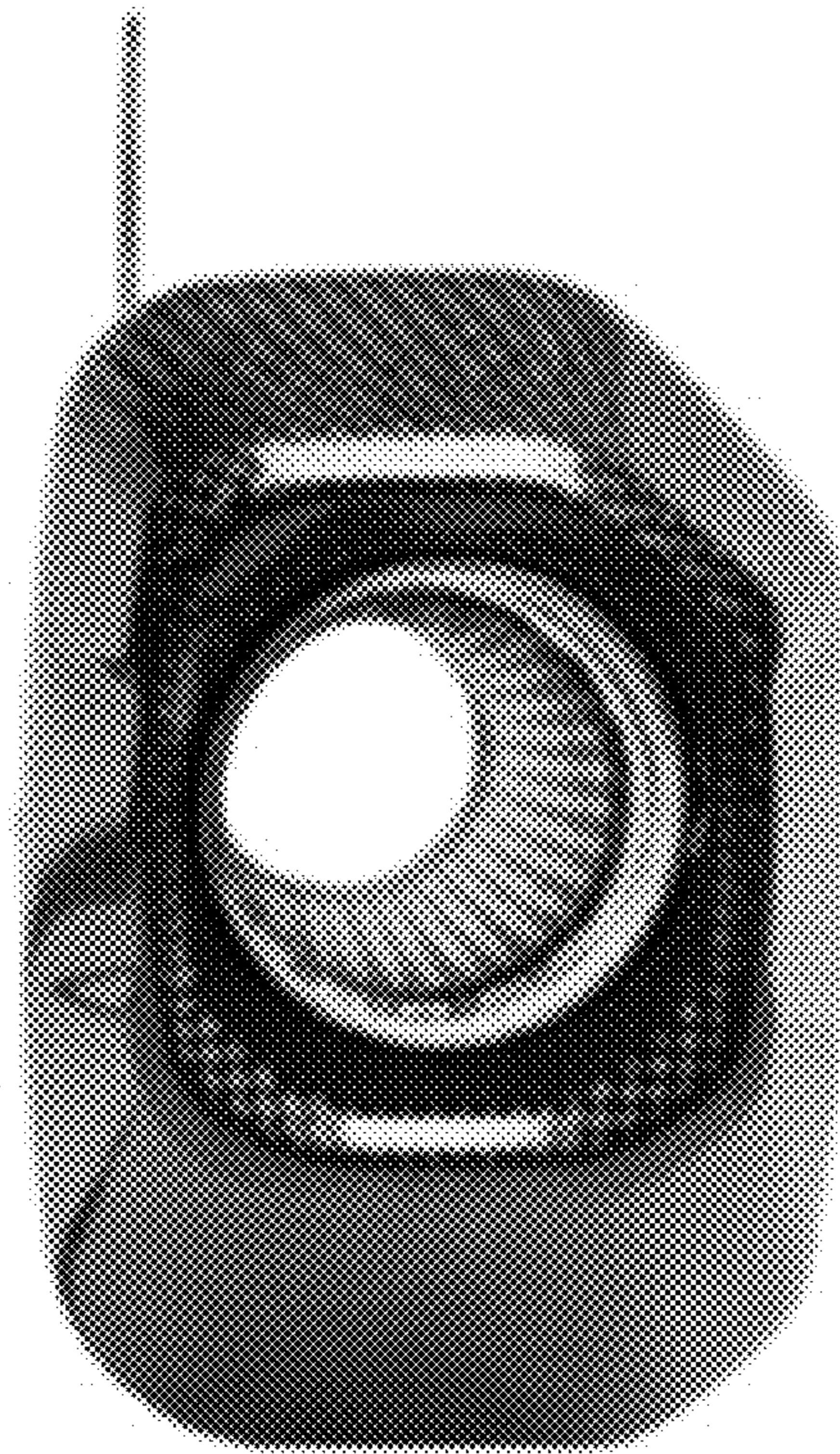

1.8

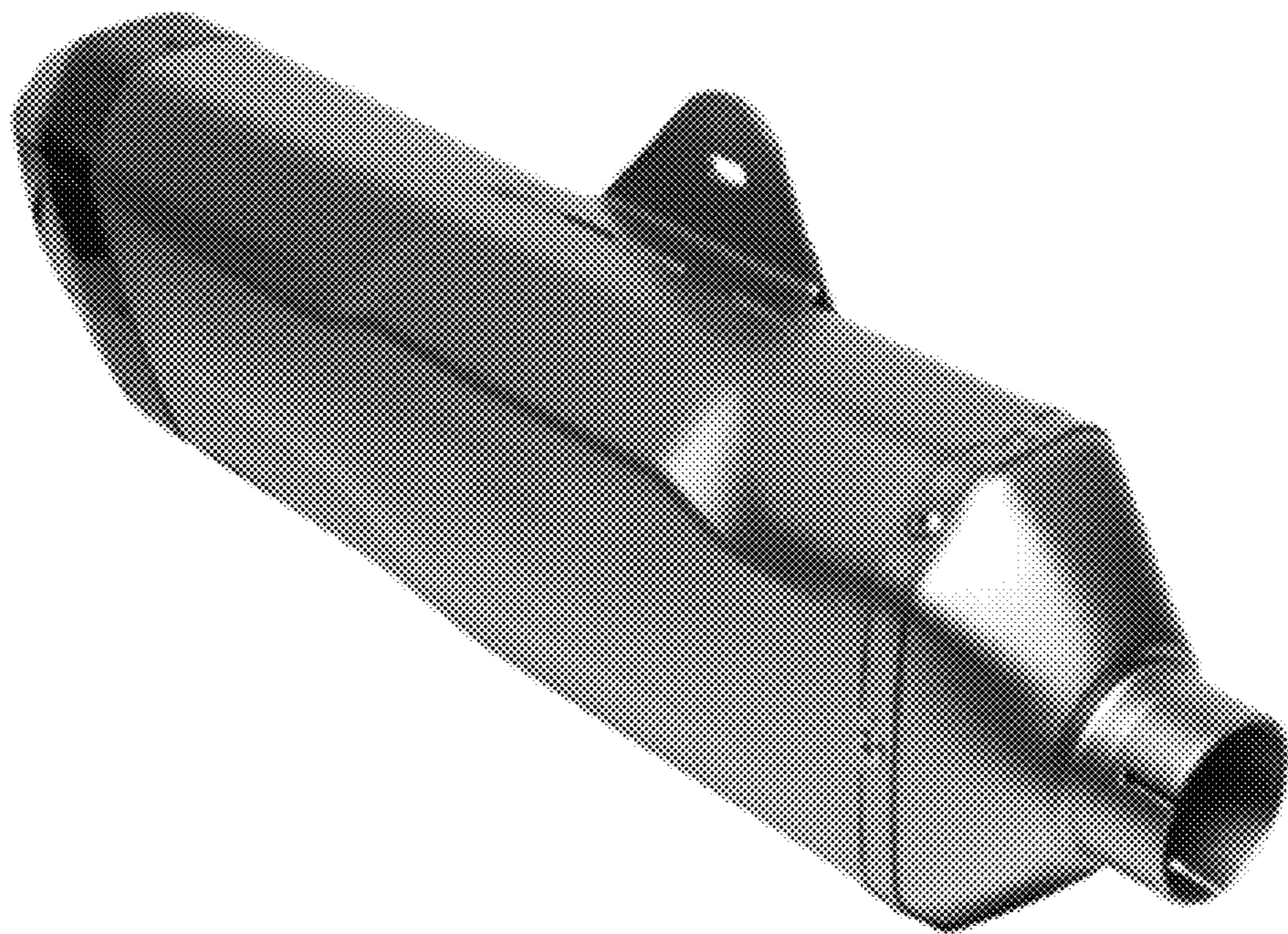

1.9

