



US00D833931S

(12) **United States Design Patent** (10) **Patent No.:** **US D833,931 S**
Lu (45) **Date of Patent:** **** Nov. 20, 2018**

(54) **REAR SPOILER**
(71) Applicant: **Turn 5, Inc.**, Malvern, PA (US)
(72) Inventor: **Shunguo Lu**, Danyang (CN)
(73) Assignee: **Turn 5, Inc.**, Paoli, PA (US)
(**) Term: **15 Years**
(21) Appl. No.: **29/596,305**
(22) Filed: **Mar. 7, 2017**
(51) **LOC (11) Cl.** **12-16**
(52) **U.S. Cl.**
USPC **D12/181**
(58) **Field of Classification Search**
USPC D12/96, 99, 400, 181, 182, 183, 184,
D12/185, 190, 191, 192, 195
CPC B60R 13/02; B60R 13/04; B62D 35/02;
B62D 35/005; B62D 35/007
See application file for complete search history.

D607,386 S * 1/2010 Kulla D12/181
D654,840 S * 2/2012 Barnaba D12/190
D715,710 S * 10/2014 Beaven D12/181
D716,205 S * 10/2014 Callum D12/181
D725,559 S * 3/2015 Robinson D12/181
D727,227 S * 4/2015 Scheinhutte D12/181
D727,809 S * 4/2015 Scheinhutte D12/181
2009/0195016 A1* 8/2009 Schwan B62D 35/007
296/180.3

* cited by examiner

Primary Examiner — Karen S Acker
Assistant Examiner — Jerry Shiuan-Hua Hsu
(74) *Attorney, Agent, or Firm* — Schott P.C.

(57) **CLAIM**

The ornamental design for a rear spoiler, as shown and described.

DESCRIPTION

FIG. 1 is a perspective front view of the rear spoiler of the present invention;
FIG. 2 is a right side view thereof;
FIG. 3 is a left view thereof;
FIG. 4 is a front elevation view thereof;
FIG. 5 is a rear elevation view thereof;
FIG. 6 is a top view thereof; and,
FIG. 7 is a bottom view thereof.

1 Claim, 5 Drawing Sheets

(56) **References Cited**
U.S. PATENT DOCUMENTS
4,558,898 A * 12/1985 Deaver B62D 35/007
264/251
D465,180 S * 11/2002 Yokomaku D12/181
D514,486 S * 2/2006 Preuninger D12/181
7,052,074 B2 * 5/2006 Dringenberg B62D 35/007
296/180.5
D547,707 S * 7/2007 Kulla D12/181

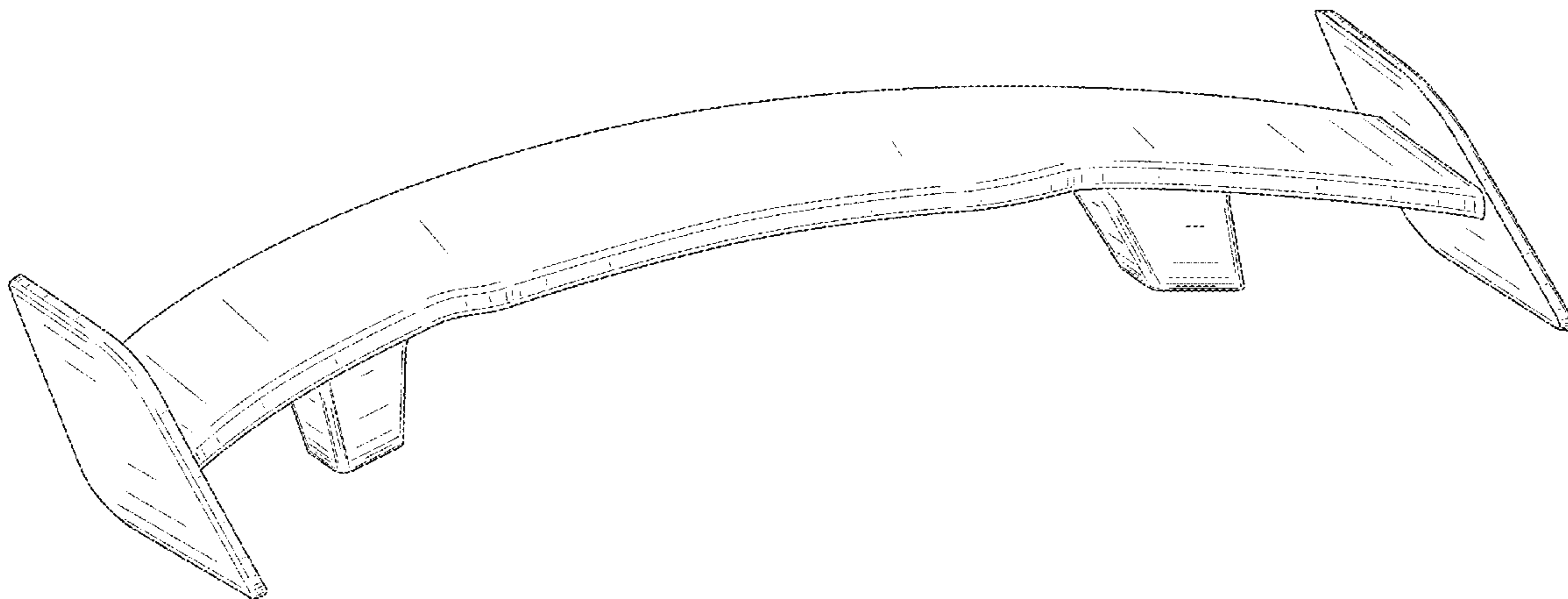

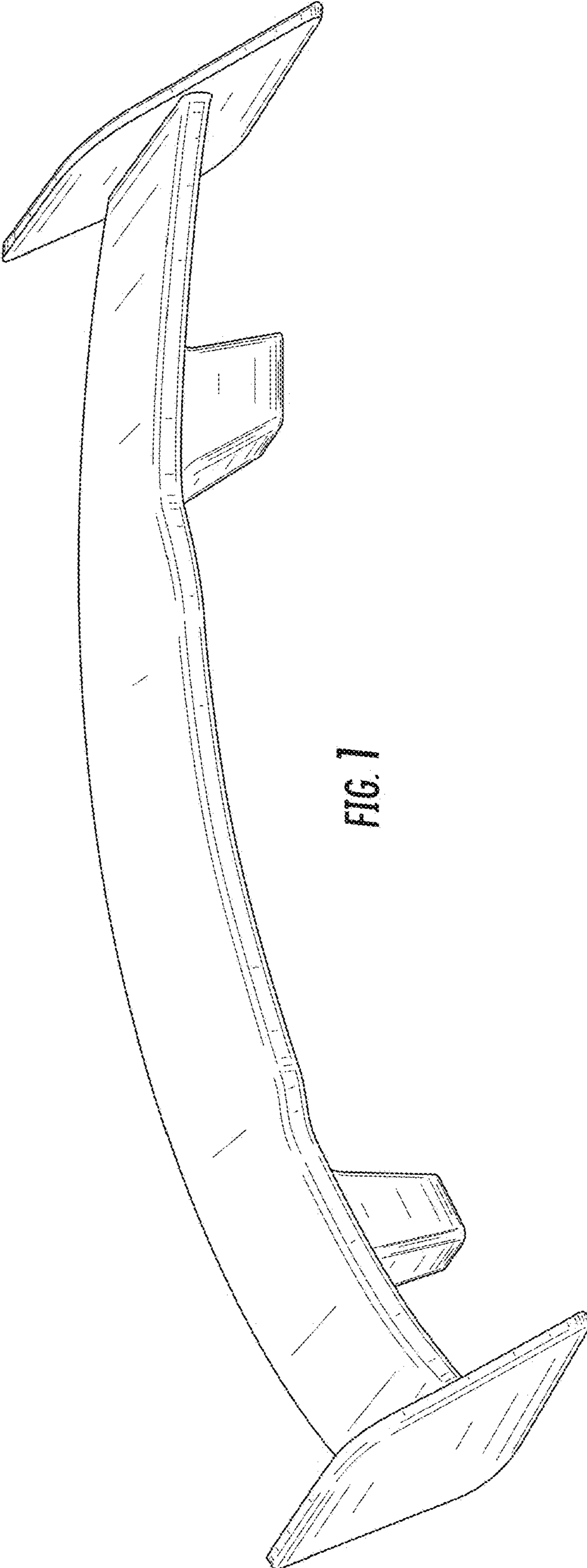

FIG. 1

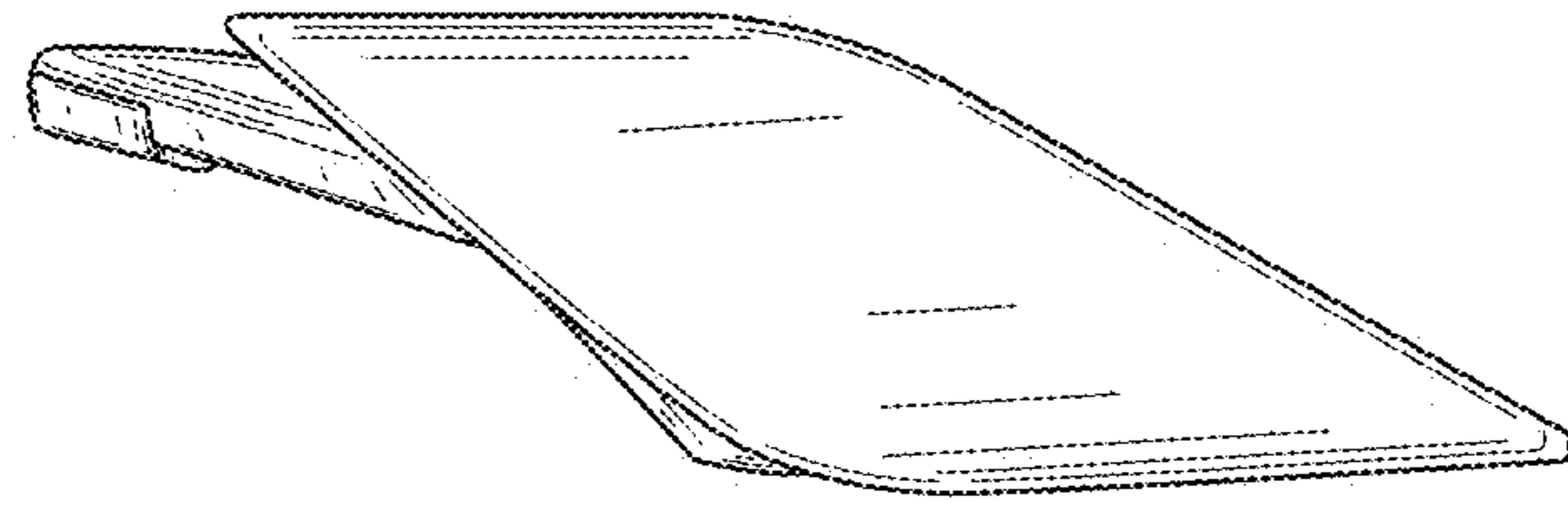

FIG. 2

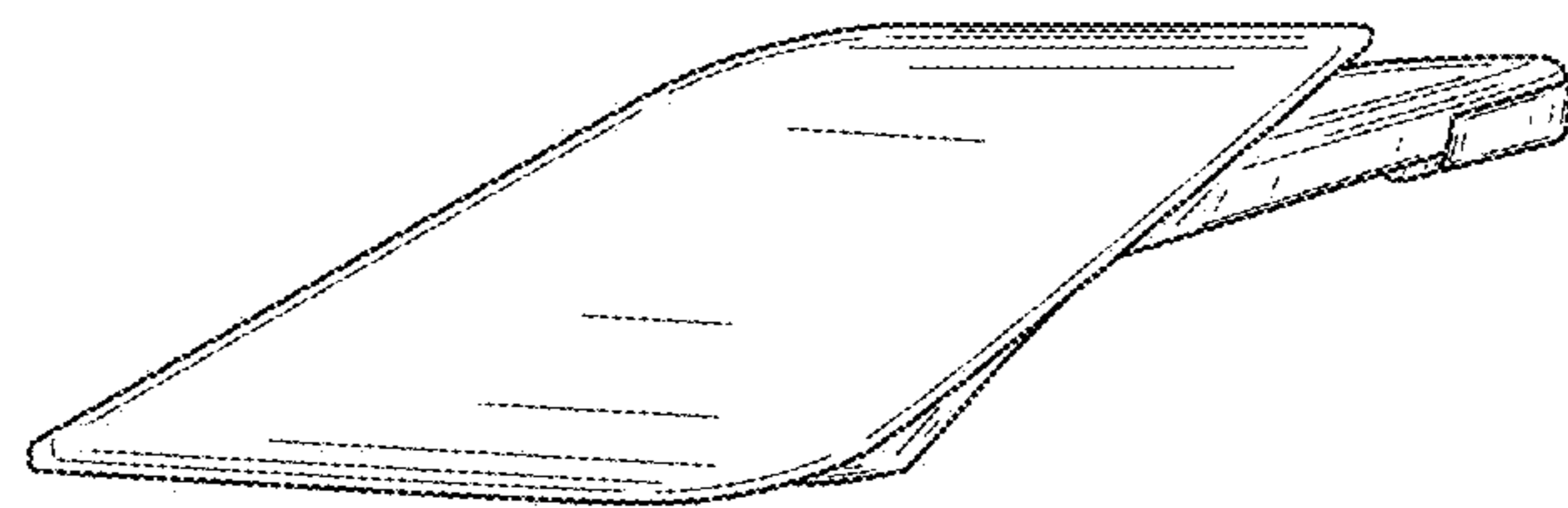

FIG. 3

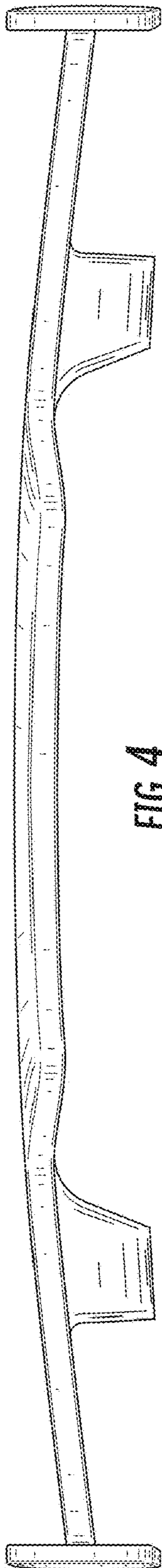

FIG. 4

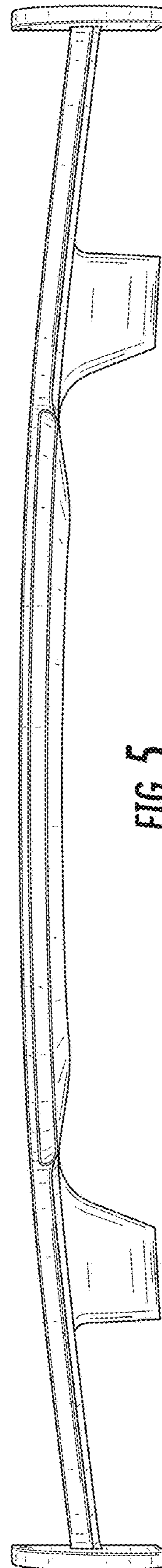

FIG. 5

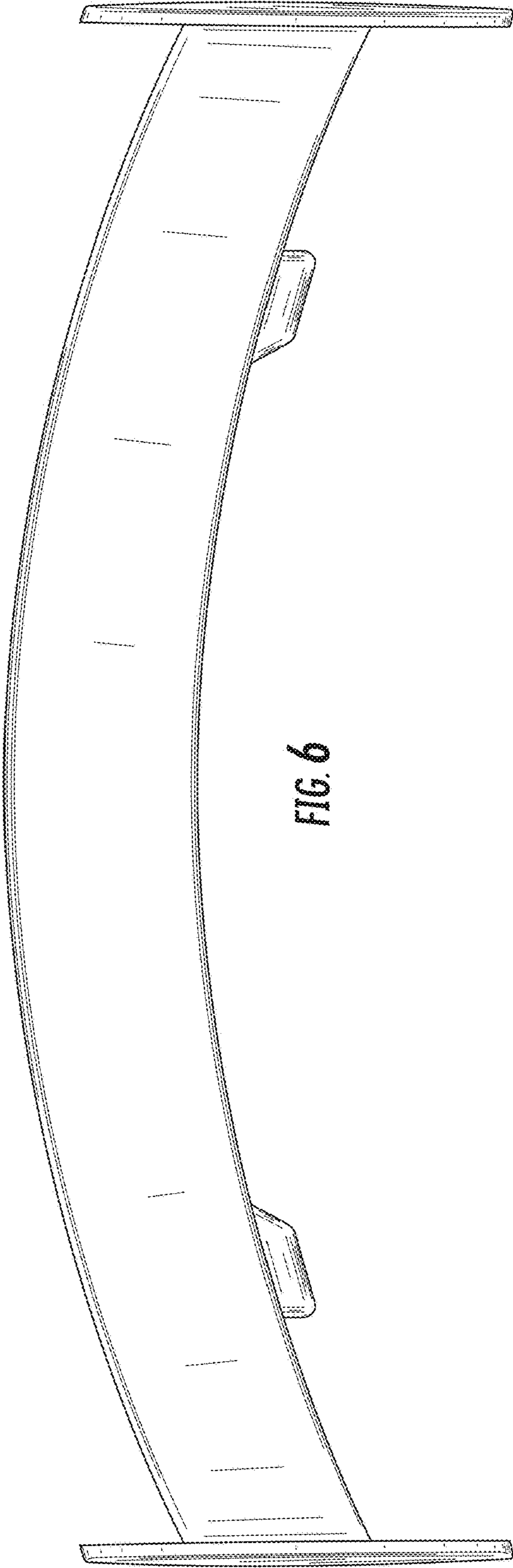

FIG. 6

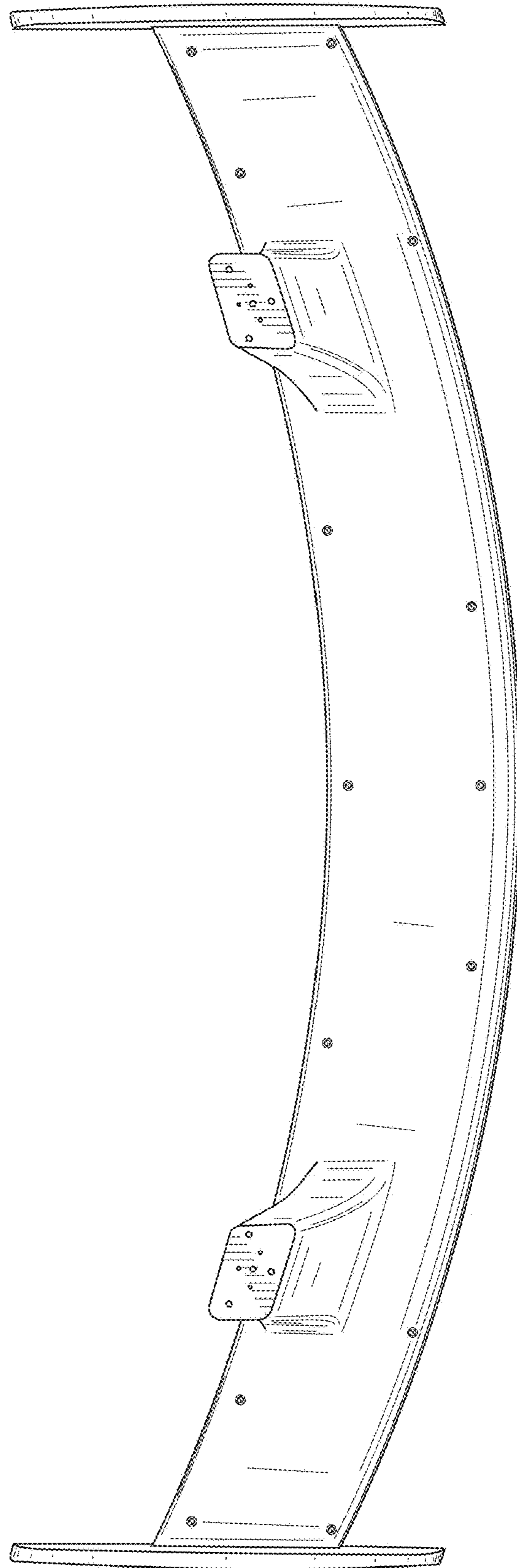

FIG. 7