



US00D833859S

(12) **United States Design Patent** (10) **Patent No.:** **US D833,859 S**
Gorham, III (45) **Date of Patent:** **** Nov. 20, 2018**

(54) **DOOR KNOCKER**

(71) Applicant: **Alonzo Dumay Gorham, III**,
Wilmington, NC (US)

(72) Inventor: **Alonzo Dumay Gorham, III**,
Wilmington, NC (US)

(**) Term: **15 Years**

(21) Appl. No.: **29/601,028**

(22) Filed: **Apr. 18, 2017**

(51) **LOC (11) Cl.** **10-06**

(52) **U.S. Cl.**
USPC **D8/401**

(58) **Field of Classification Search**
USPC D8/401; D21/769
CPC B63B 35/79; G10K 3/00
See application file for complete search history.

(56) **References Cited**

U.S. PATENT DOCUMENTS

D23,446 S *	7/1894	Kiefer	D19/65
D72,236 S *	3/1927	Pickard	D8/401
D142,372 S *	9/1945	Brown	D8/324
2,405,916 A *	8/1946	Neuhaus	G10K 3/00
			116/167
D208,970 S *	10/1967	Sawallesh	D11/134
D349,935 S *	8/1994	Simonson	D21/769
D403,502 S *	1/1999	Winter	D3/211
D503,561 S *	4/2005	Sloan	D21/769
D503,763 S *	4/2005	Morgan	D21/769
D673,233 S *	12/2012	Baggett	D21/769
2016/0144935 A1 *	5/2016	Harrell	B32B 7/06
			156/247

OTHER PUBLICATIONS

Surfboard Wall Art Greg Noll Surfboards, posted Jan. 7, 2018,
[retrieved Jun. 22, 2018]. Retrieved from Internet, <URL: http://

kholina.info/wall-surfboards/wall-decor-surfboard-wall-art-home-decorations-surfboard-decor-surfboard-wall-art-home-decorations-ideas-greg-noll-surfboards/ >.*
Surfboard Wall Decor, posted Apr. 30, 2018, [retrieved Jun. 22, 2018]. Retrieved from Internet, <URL: http://thaiteacherstv.net/surfboard-wall-decor-2/ >.*
Brass Accents Oval Traditional Push or Pull Plate—3×11 Inch, posted unknown, [retrieved Jun. 22, 2018]. Retrieved from Internet, <URL: http://www.directdoorhardware.com/BA_Oval_Push_Plate.htm >.*
Brass surfboard door knocker surk sport sea shell ocean—WorthPoint, posted Mar. 26, 2017, [retrieved Jul. 23, 2018]. Retrieved from Internet, <URL:https://www.worthpoint.com/worthopedia/brass-surfboard-door-knocker-surf-503648638.

* cited by examiner

Primary Examiner — Barbara Fox

Assistant Examiner — Kristin E Reed

(74) *Attorney, Agent, or Firm* — Russell D. Nugent; The Humphries Law Firm, P.C.

(57) **CLAIM**

The ornamental design for a door knocker, as shown and described.

DESCRIPTION

FIG. 1 is a top perspective view of a door knocker showing my new design;
FIG. 2 is a rear elevational view thereof;
FIG. 3 is a front elevational view thereof;
FIG. 4 is a left elevational view thereof;
FIG. 5 is a right elevational view thereof;
FIG. 6 is a top plan view thereof;
FIG. 7 is a bottom plan view thereof;
FIG. 8 is a bottom perspective view thereof; and,
FIG. 9 is a left, perspective view thereof.
FIGS. 1 through 9 illustrate a door knocker. The broken lines shown in the figures depict portions of the door knocker that form no part of the claimed design.

1 Claim, 6 Drawing Sheets

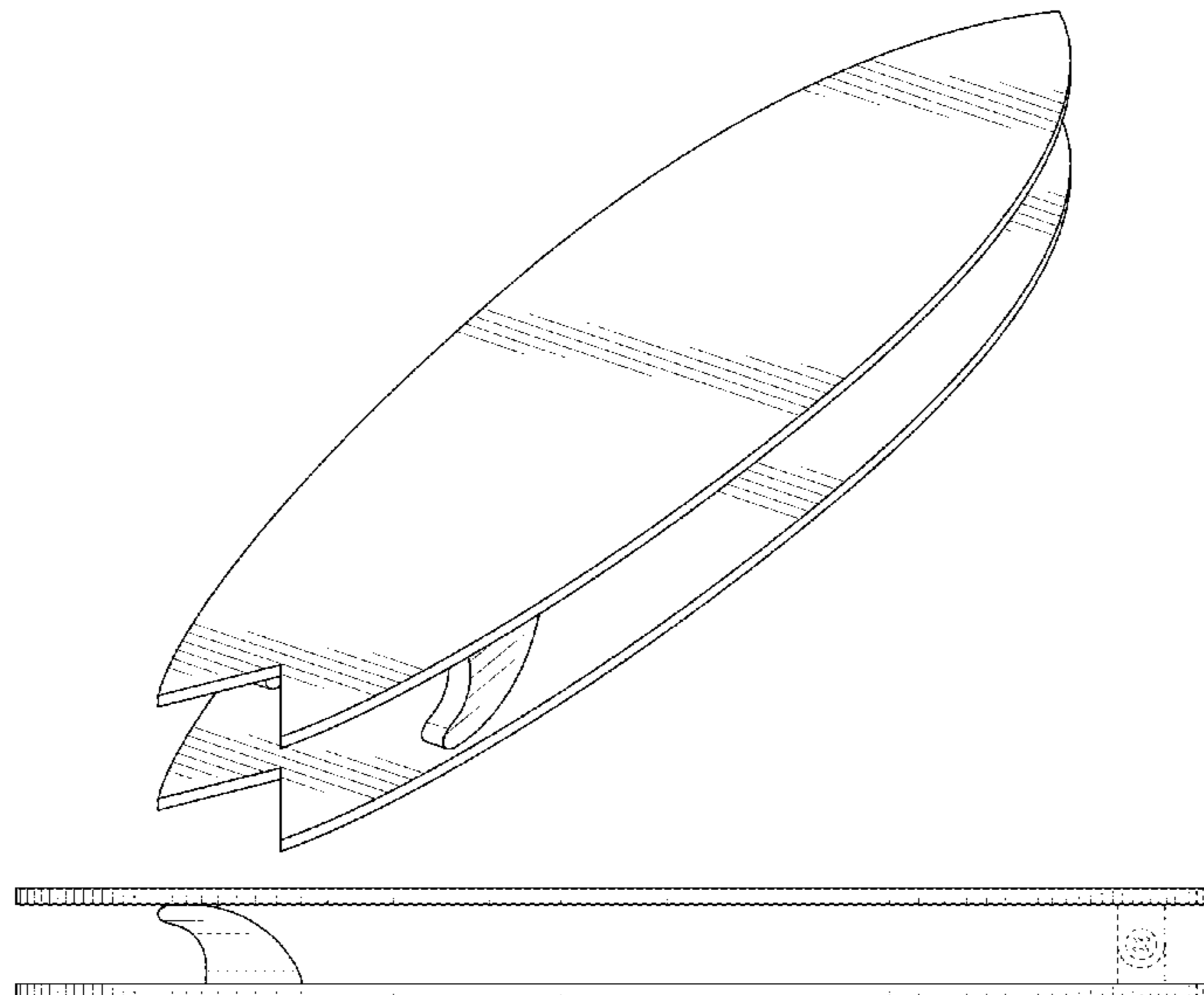

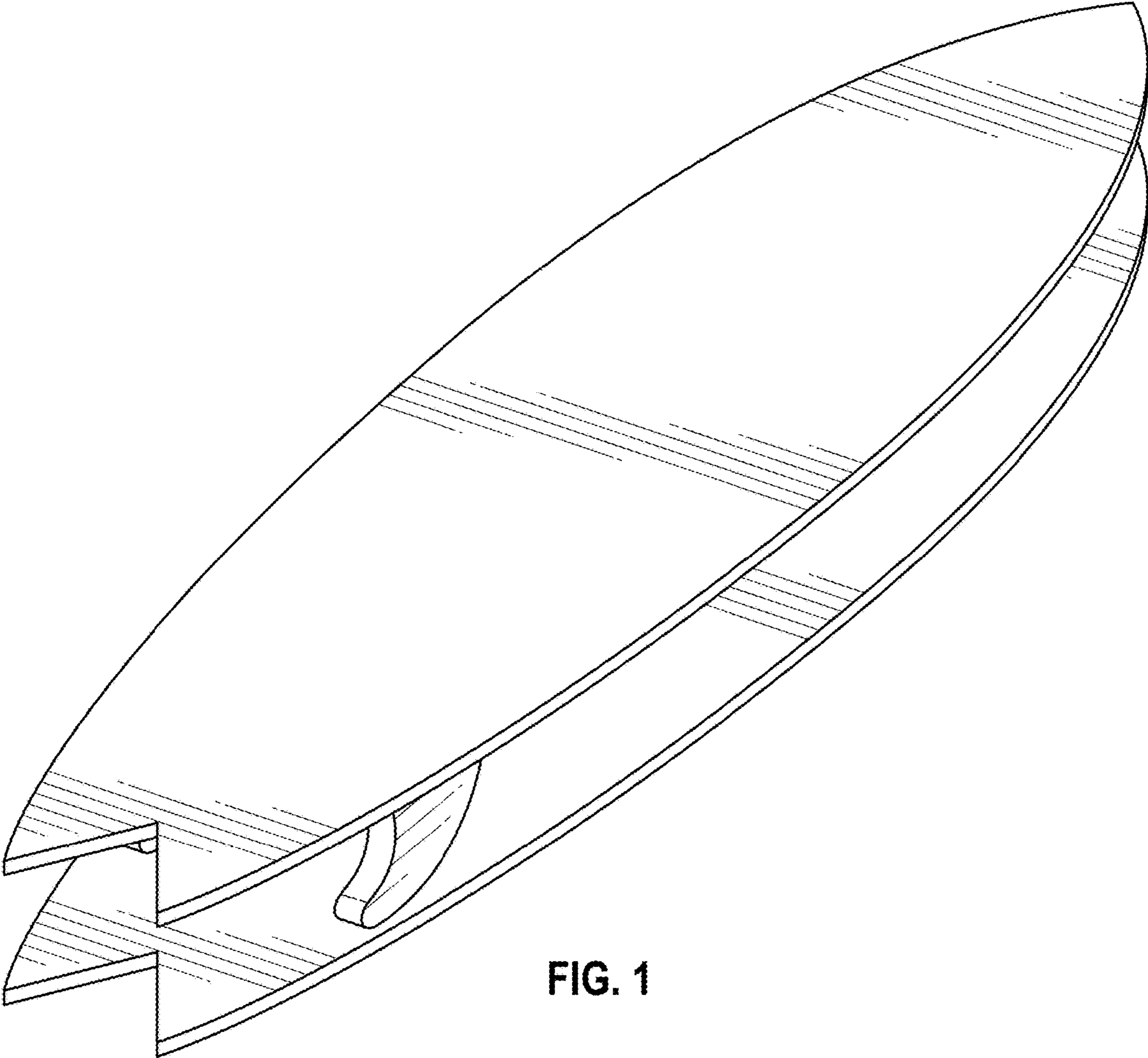

FIG. 1

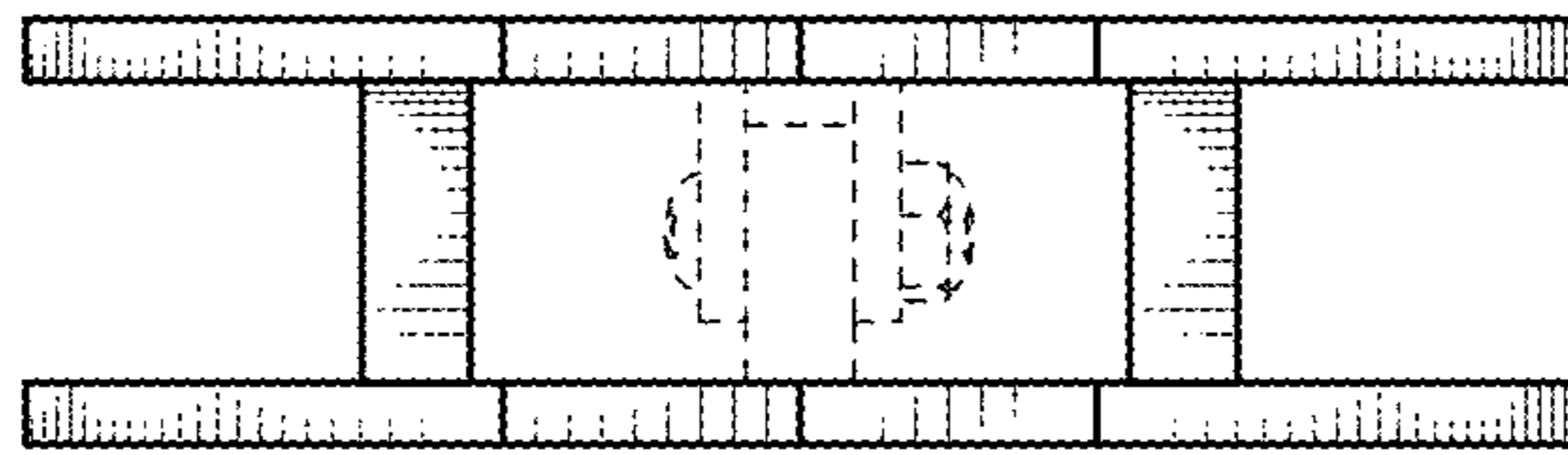

FIG. 2

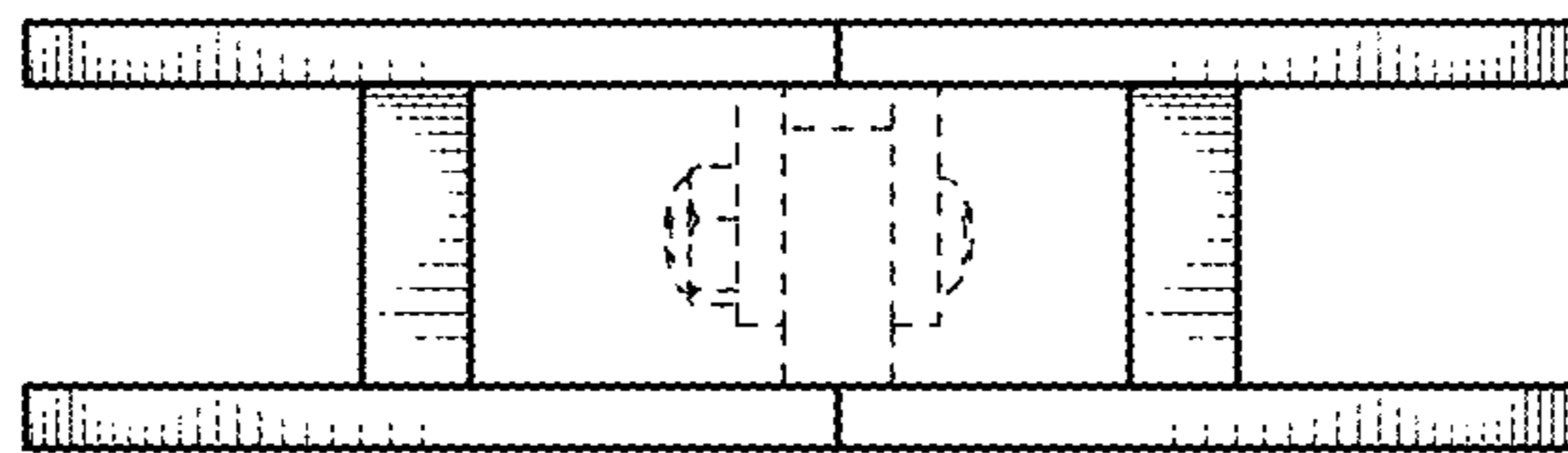

FIG. 3

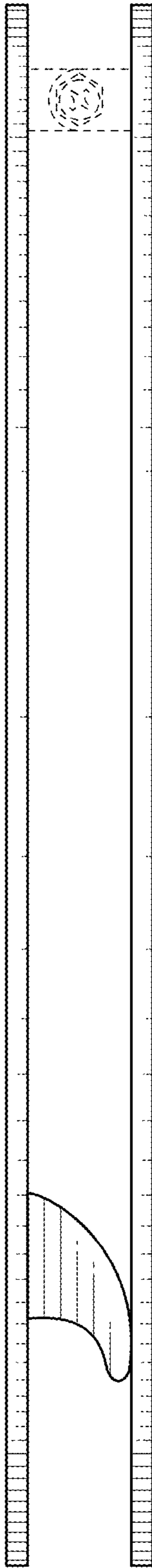

FIG. 4

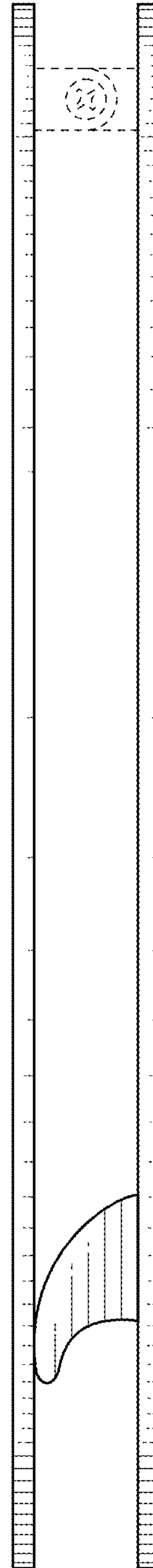

FIG. 5

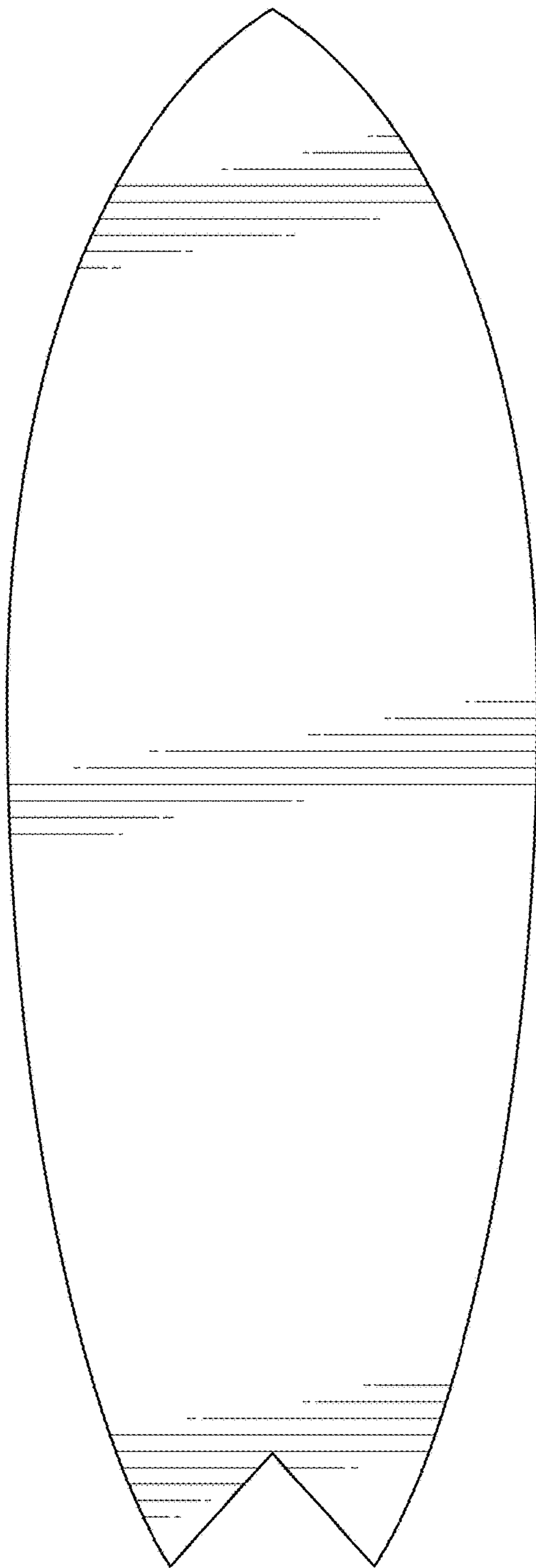

FIG. 6

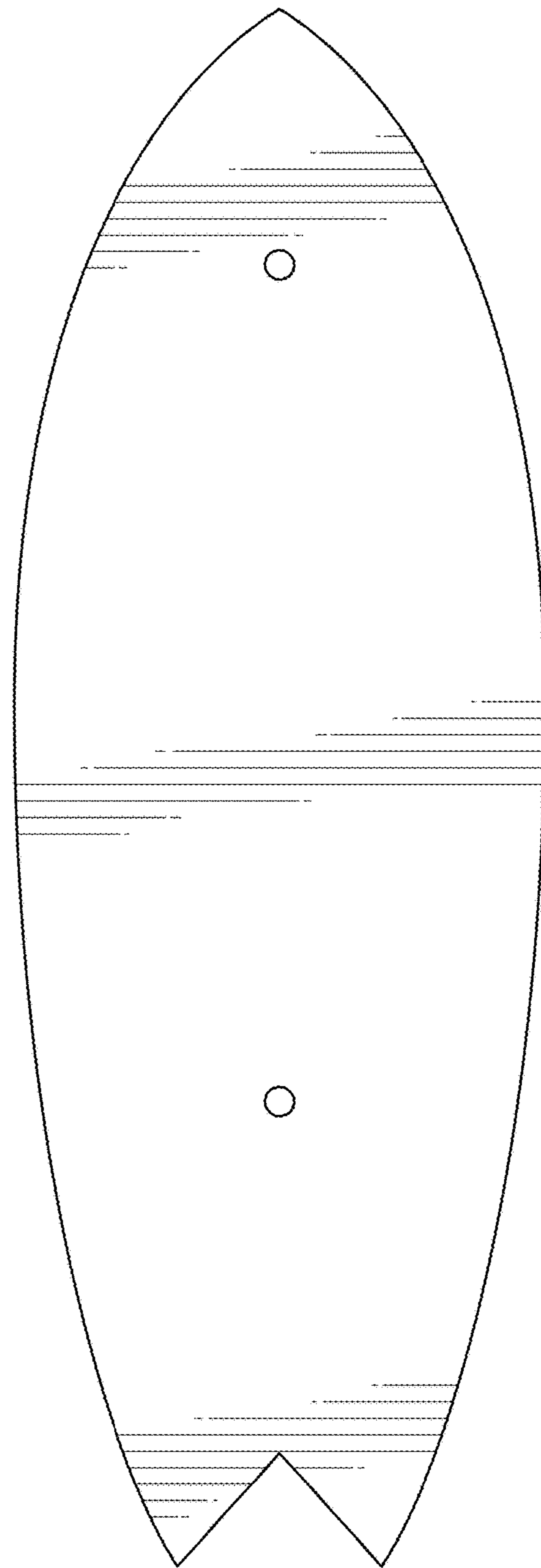

FIG. 7

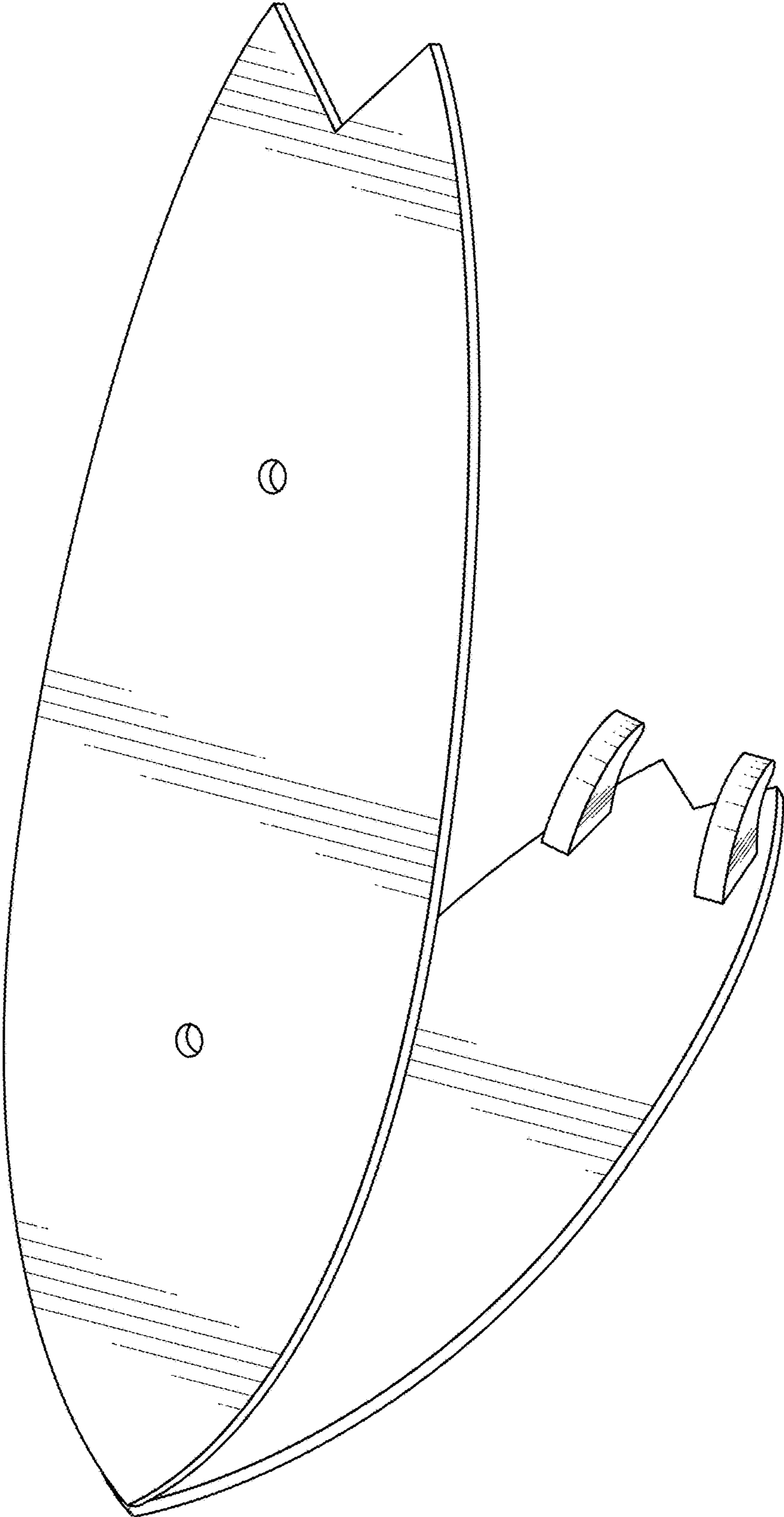

FIG. 8

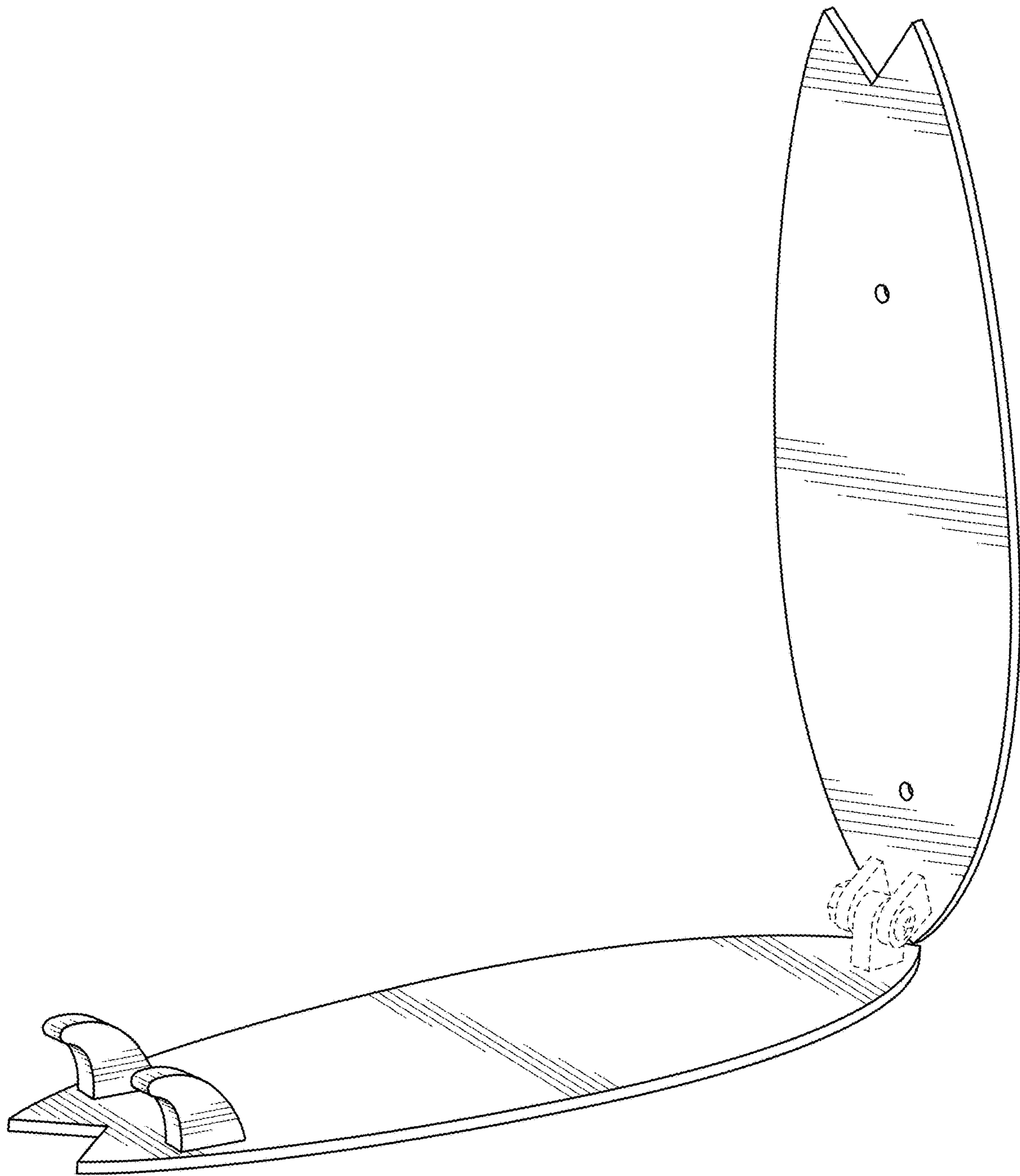

FIG. 9