



US00D833771S

(12) **United States Design Patent** (10) **Patent No.:** **US D833,771 S**
Gawlik et al. (45) **Date of Patent:** **** Nov. 20, 2018**

(54) **PRODUCT CONTAINER HOLDER**

(71) Applicants: **Nancy Carol Gawlik**, Janesville, WI (US); **Richard Edmund Koval**, Elkhorn, WI (US)

(72) Inventors: **Nancy Carol Gawlik**, Janesville, WI (US); **Richard Edmund Koval**, Elkhorn, WI (US)

(**) Term: **15 Years**

(21) Appl. No.: **29/593,022**

(22) Filed: **Feb. 5, 2017**

(51) **LOC (11) Cl.** **08-08**

(52) **U.S. Cl.**
USPC **D6/553**

(58) **Field of Classification Search**
USPC D6/553, 518, 519-523, 566, 513, 552; D24/189, 190, 192, 206; 211/86.01, 211/87.01; 242/570, 590, 595; 602/60, 602/61, 62, 64, 65, 66, 70, 74; D7/631; D8/373
CPC Y10S 248/905; Y10S 248/902; A47K 10/185; B60R 7/084; B60R 11/00; A47G 29/08

See application file for complete search history.

(56) **References Cited**

U.S. PATENT DOCUMENTS

3,801,056	A	3/1974	Brody	
3,917,207	A	11/1975	Quigley	
D278,295	S *	4/1985	Thompson	D6/518
4,696,448	A	9/1987	Mazloom	
D293,182	S *	12/1987	Carter	D6/518
5,029,787	A	7/1991	Florentin	
5,065,970	A	11/1991	Gross	
5,398,856	A	3/1995	Shyu	
D374,360	S *	10/1996	Angermeir	D6/518
D419,350	S *	1/2000	Baron	D6/553

6,669,157	B1	12/2003	Willin	
D587,947	S *	3/2009	Valiulis	D6/553
2004/0245422	A1	12/2004	Pollack	
2017/0251889	A1 *	9/2017	Gawlik	A47K 10/185

* cited by examiner

Primary Examiner — Wan Laymon

Assistant Examiner — Mark Booker

(74) *Attorney, Agent, or Firm* — Monty Simmons; Simmons Patents

(57) **CLAIM**

The ornamental design for a product container holder, as shown and described.

DESCRIPTION

FIG. 1 is an elevated front perspective view of thereof; FIG. 2 is an elevational front side view thereof; FIG. 3 is an elevational back side view thereof; FIG. 4 is an elevational first side view thereof; FIG. 5 is an elevational second side view thereof; FIG. 6 is a top plan view thereof; FIG. 7 is a bottom plan view thereof; FIG. 8 is an elevated front perspective view of a square version thereof; FIG. 9 is an elevational front side view of the embodiment in FIG. 11 thereof; FIG. 10 is an elevational back side view of the embodiment in FIG. 11 thereof; FIG. 11 is an elevational first side view of the embodiment in FIG. 11 thereof; FIG. 12 is an elevational second side view t of the embodiment in FIG. 11 hereof; FIG. 13 is a top plan view of the embodiment in FIG. 11 thereof; and, FIG. 14 is a bottom plan view of the embodiment in FIG. 11 thereof.

The broken lines in a drawing illustrate environmental structure and form no part of the claimed design.

1 Claim, 14 Drawing Sheets

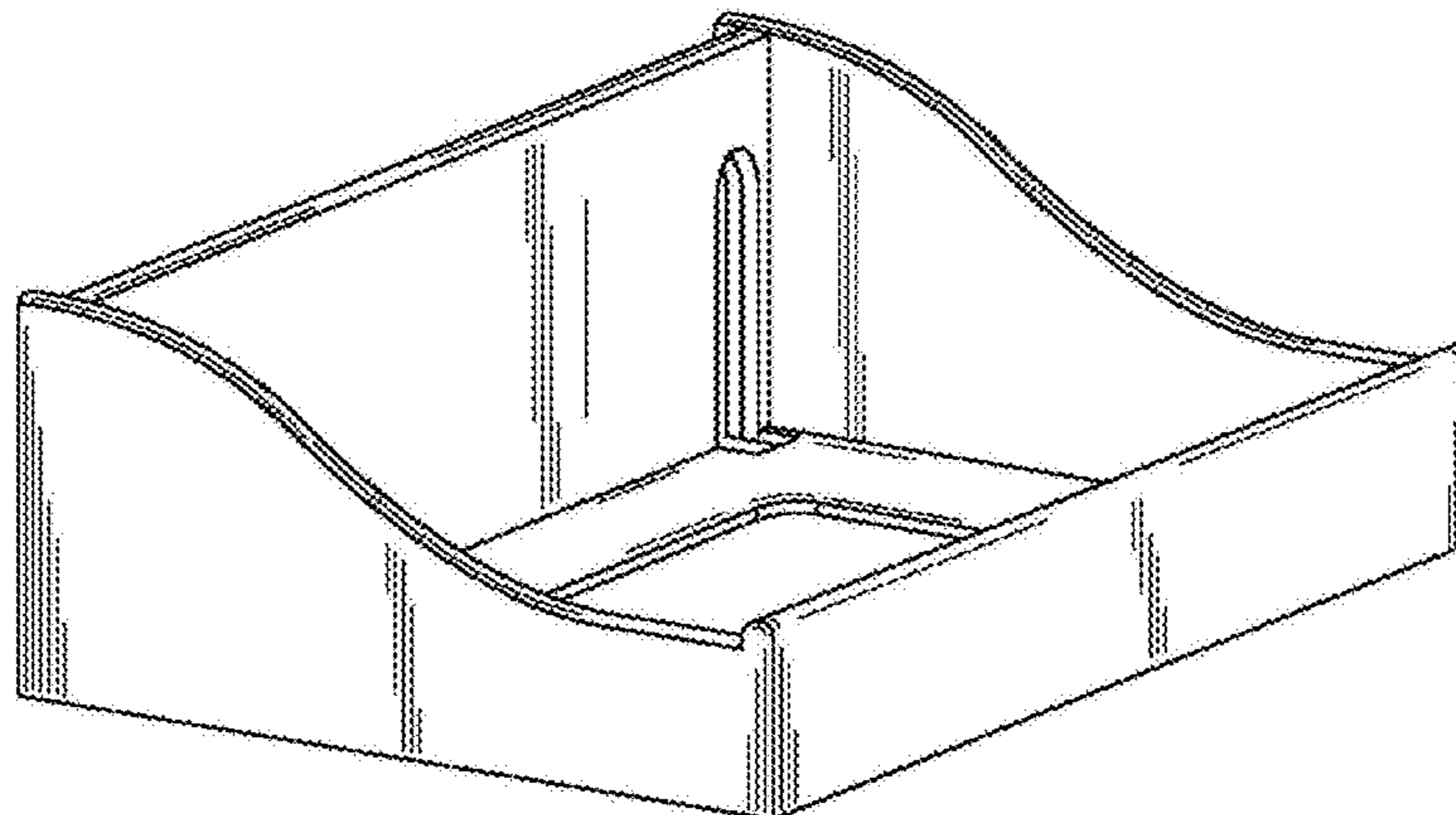

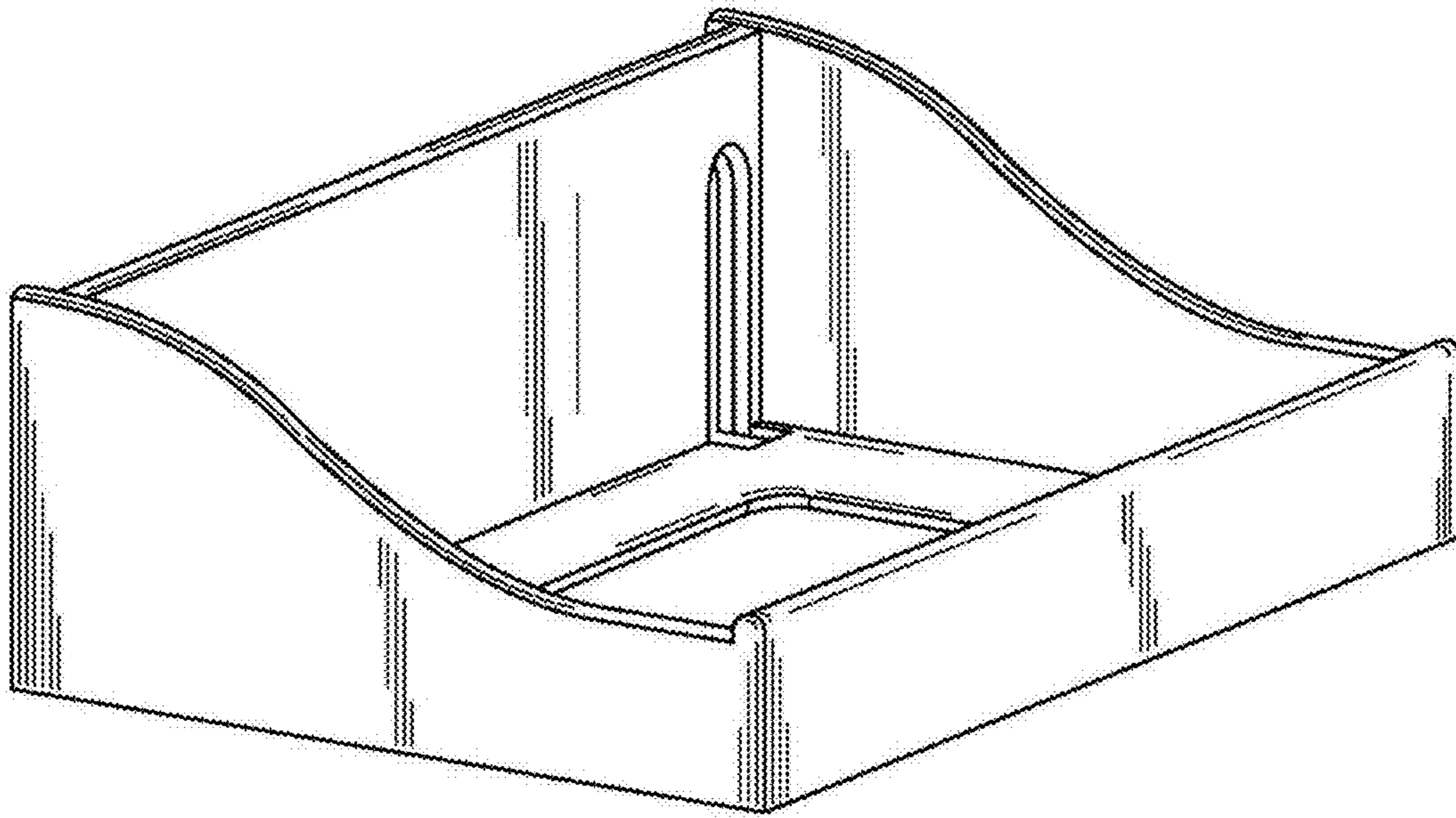

FIG. 1

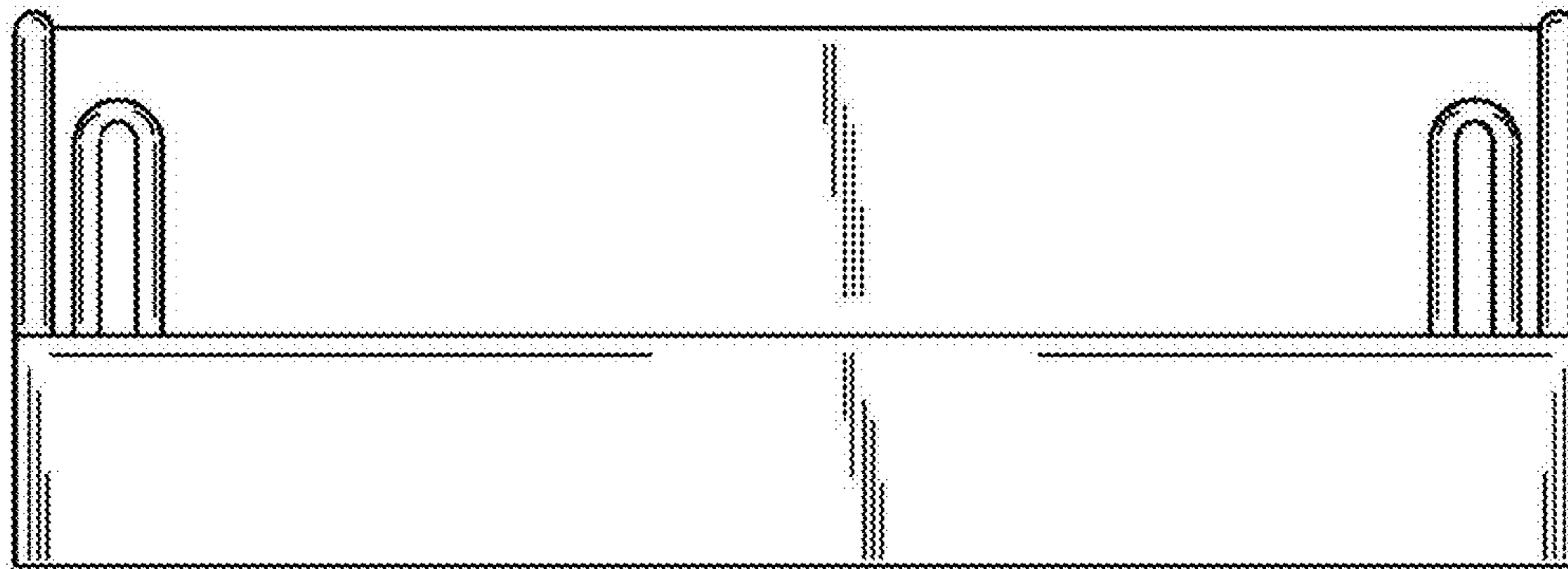

FIG. 2

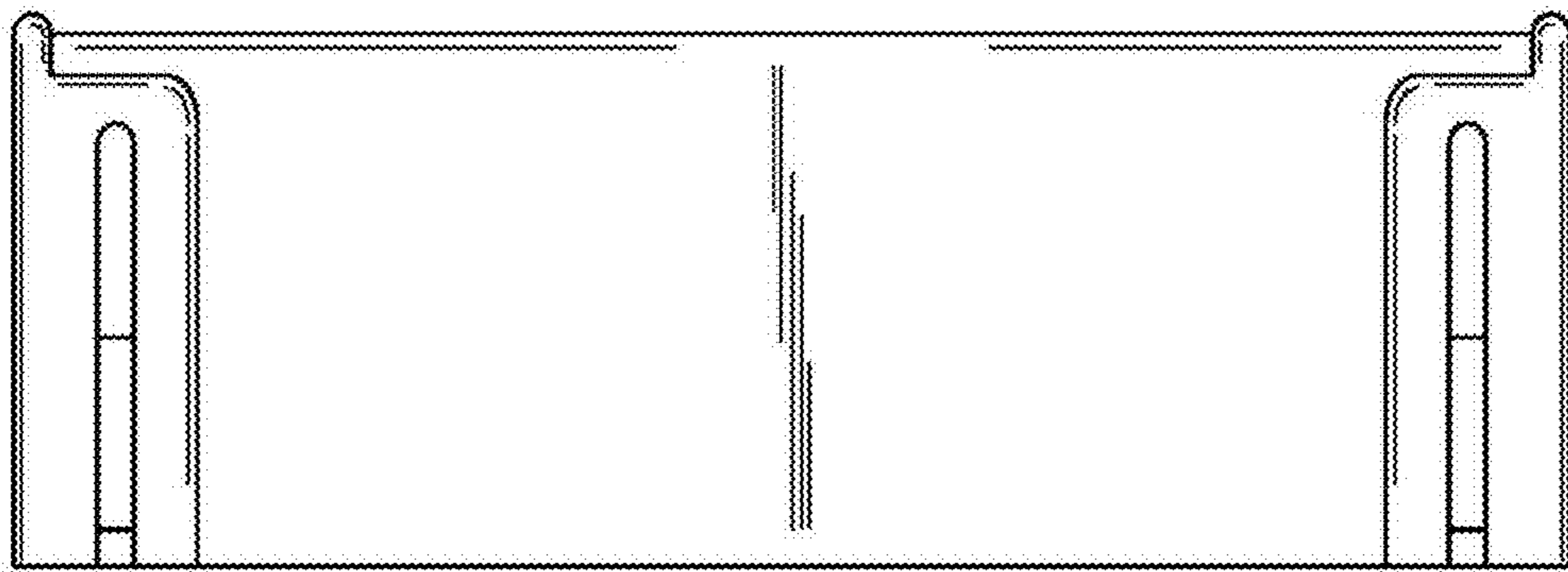

FIG. 3

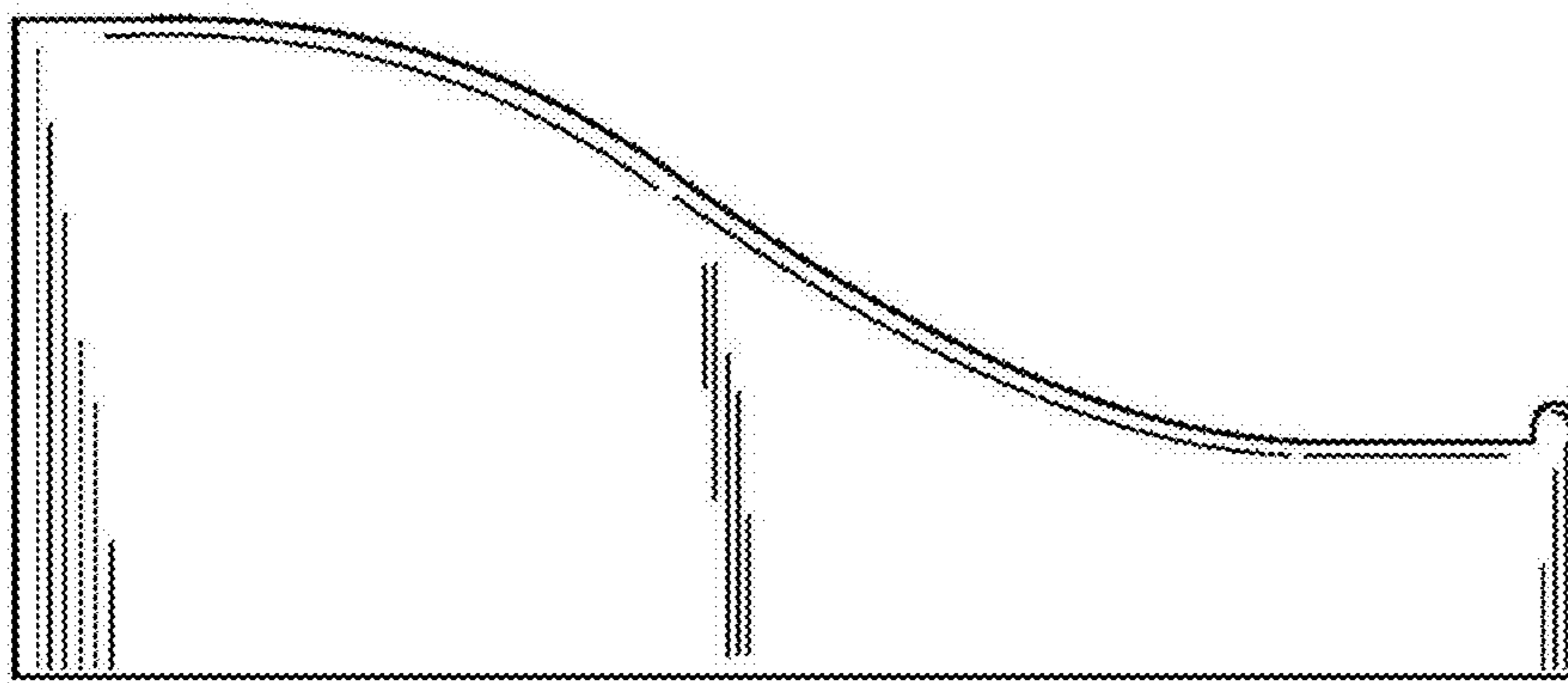

FIG. 4

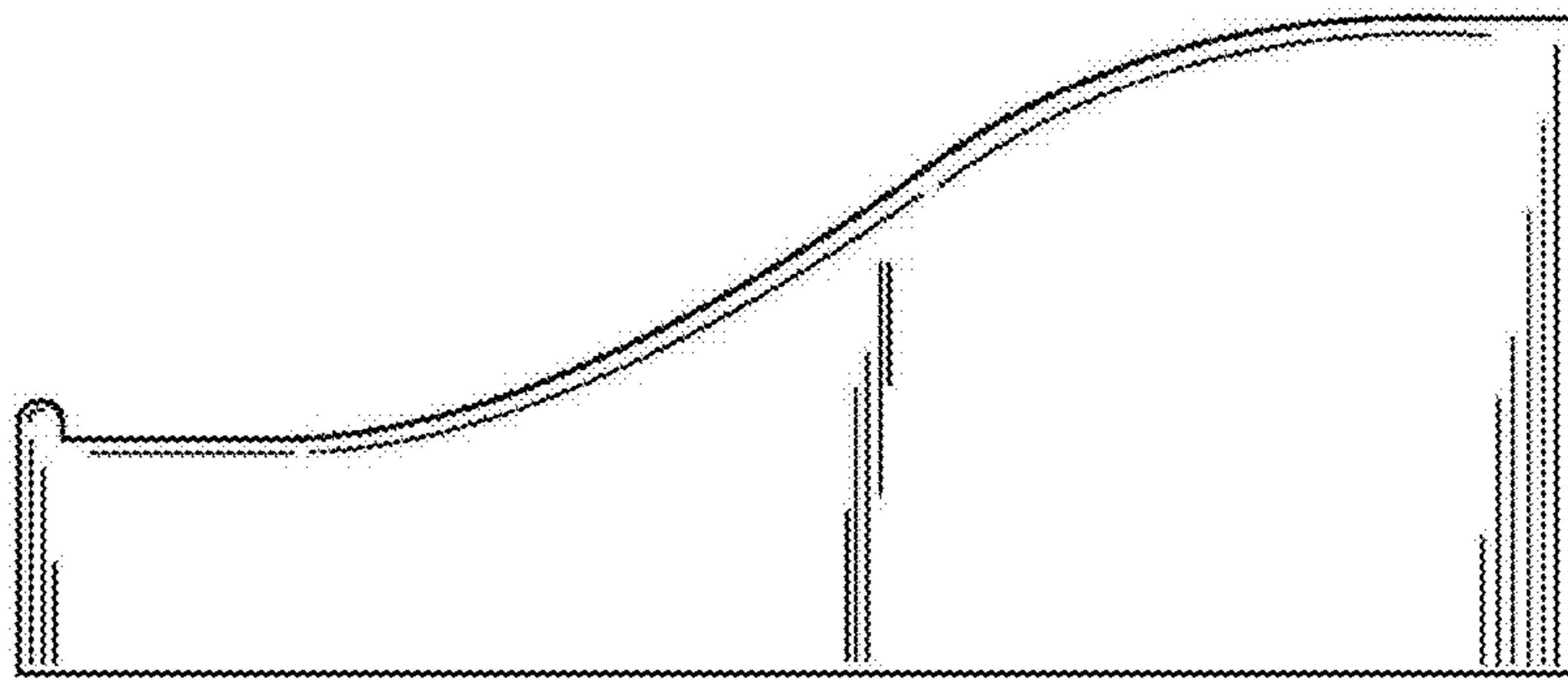

FIG. 5

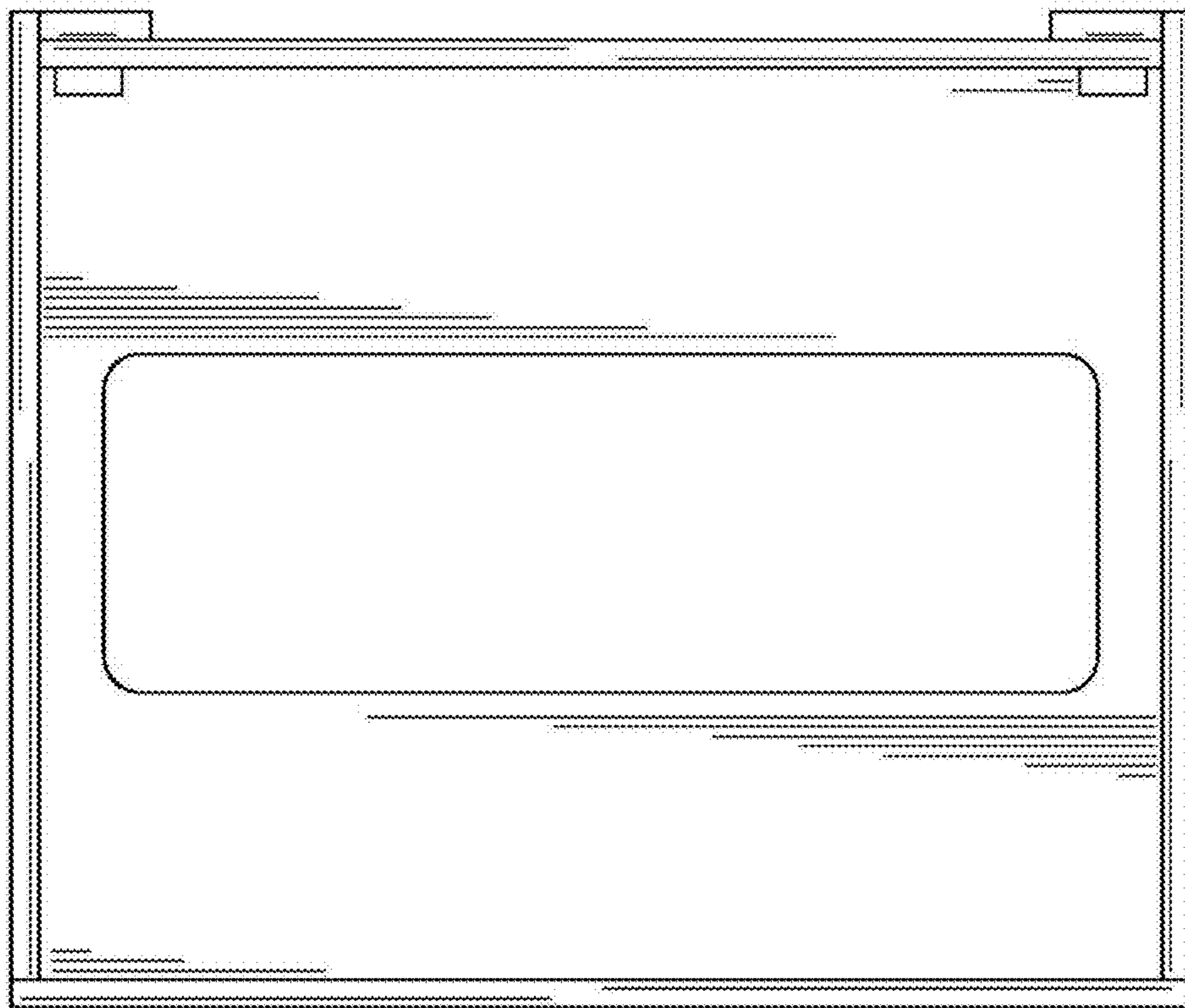

FIG. 6

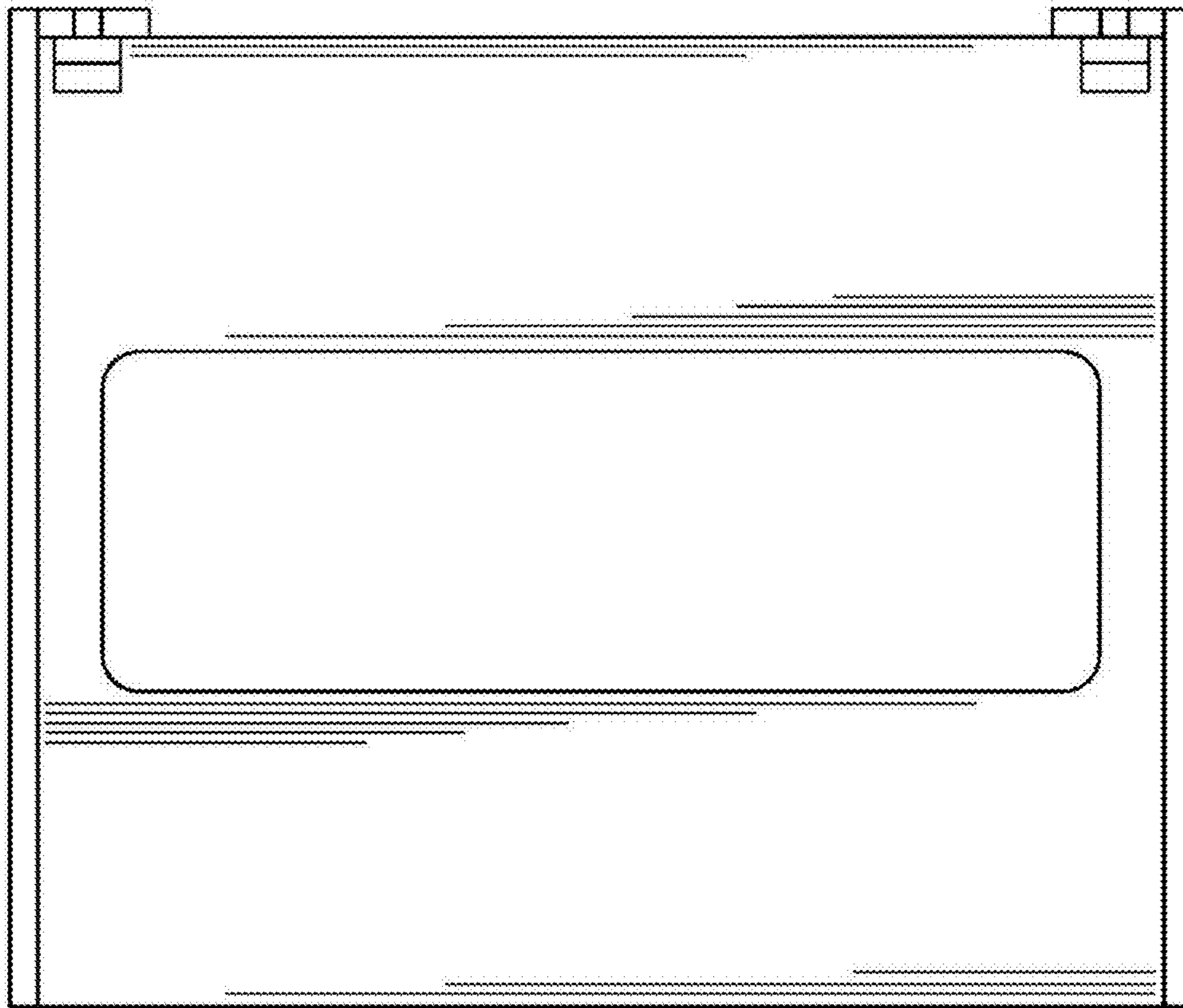

FIG. 7

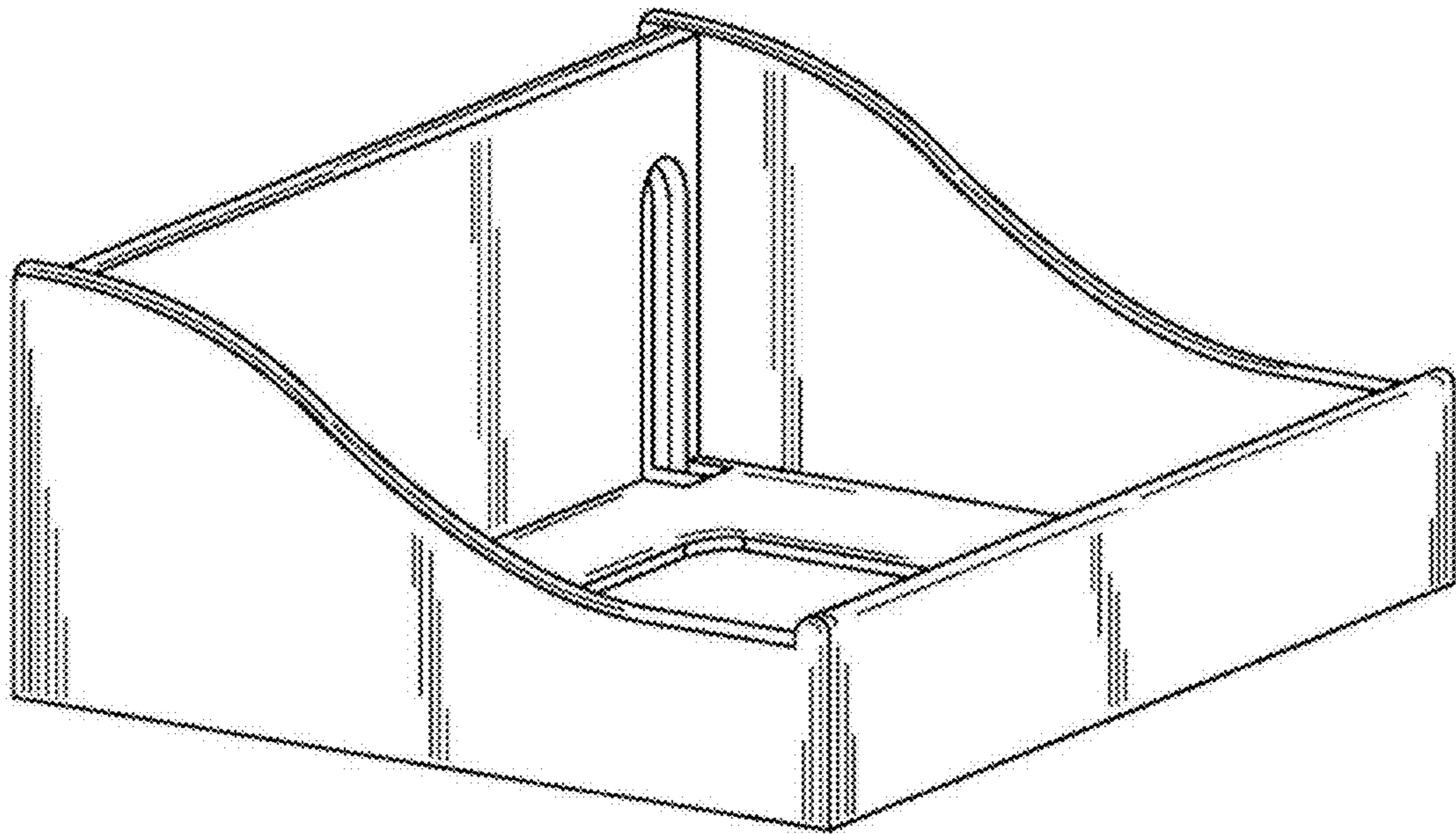

Fig. 8

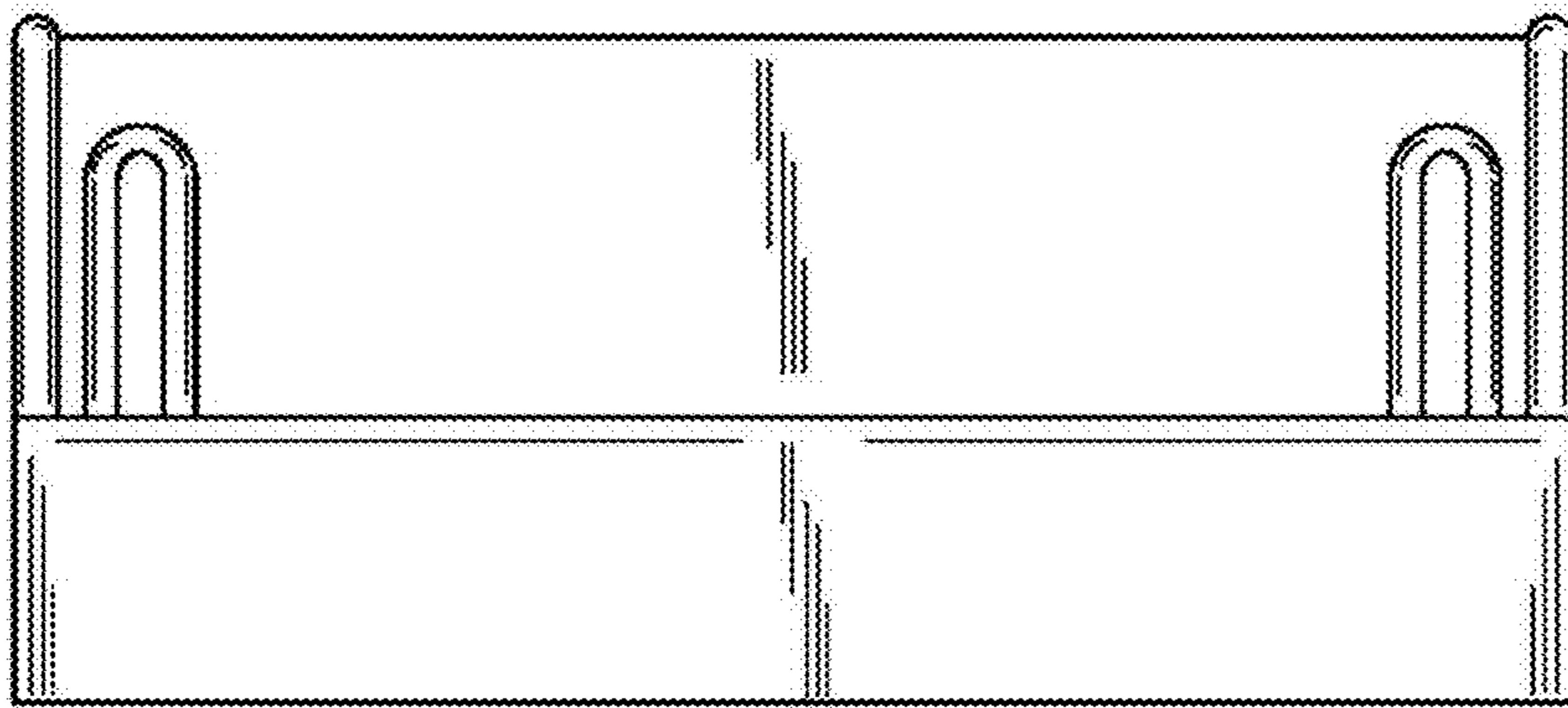

Fig. 9

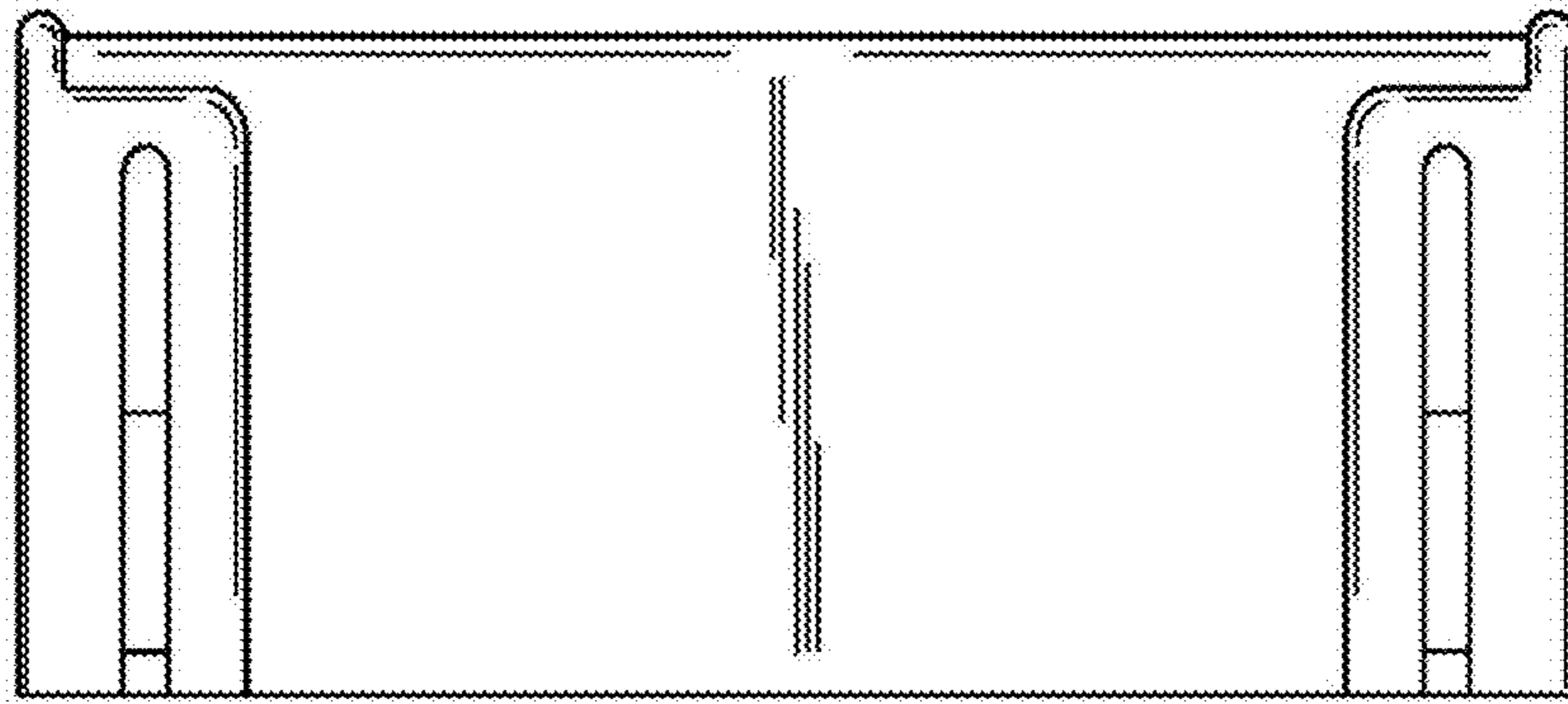

Fig. 10

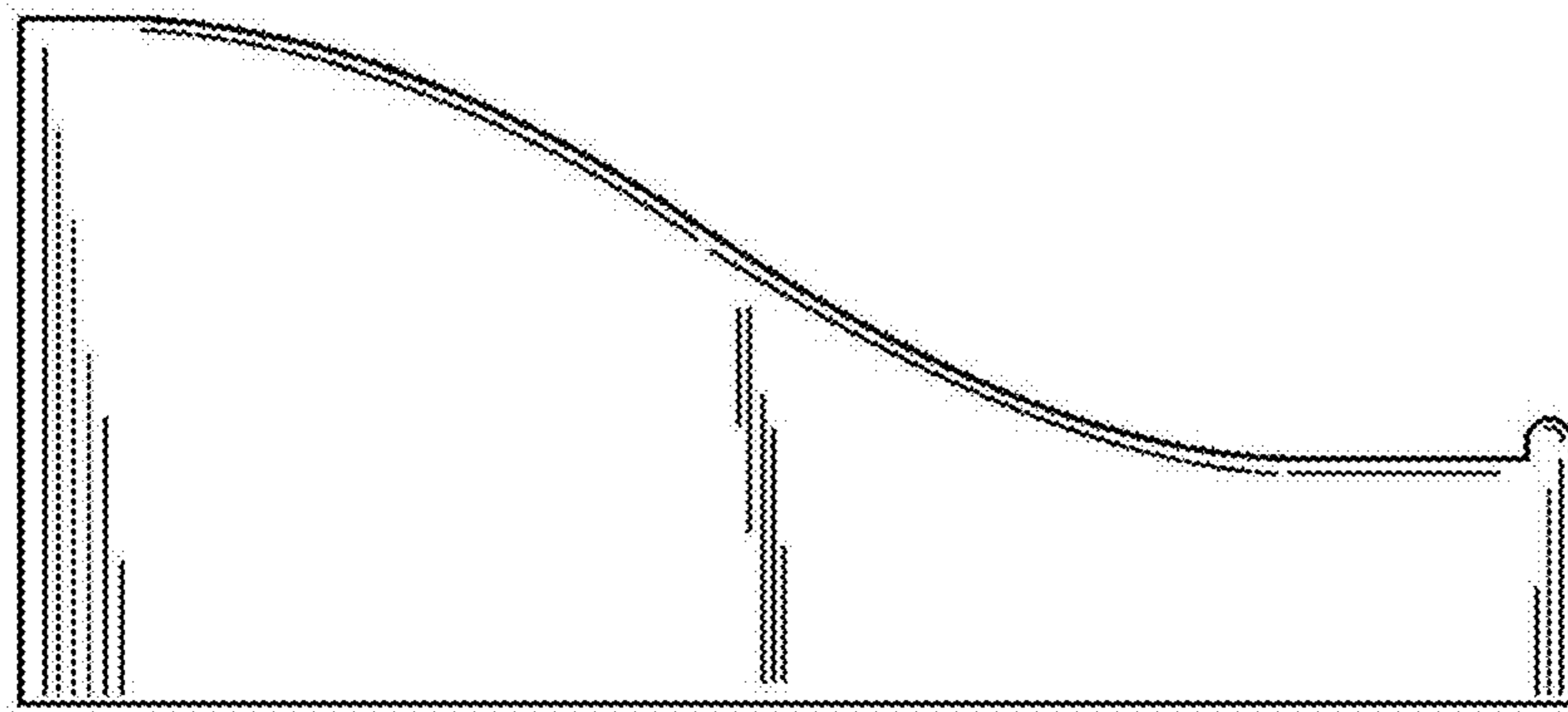

Fig. 11

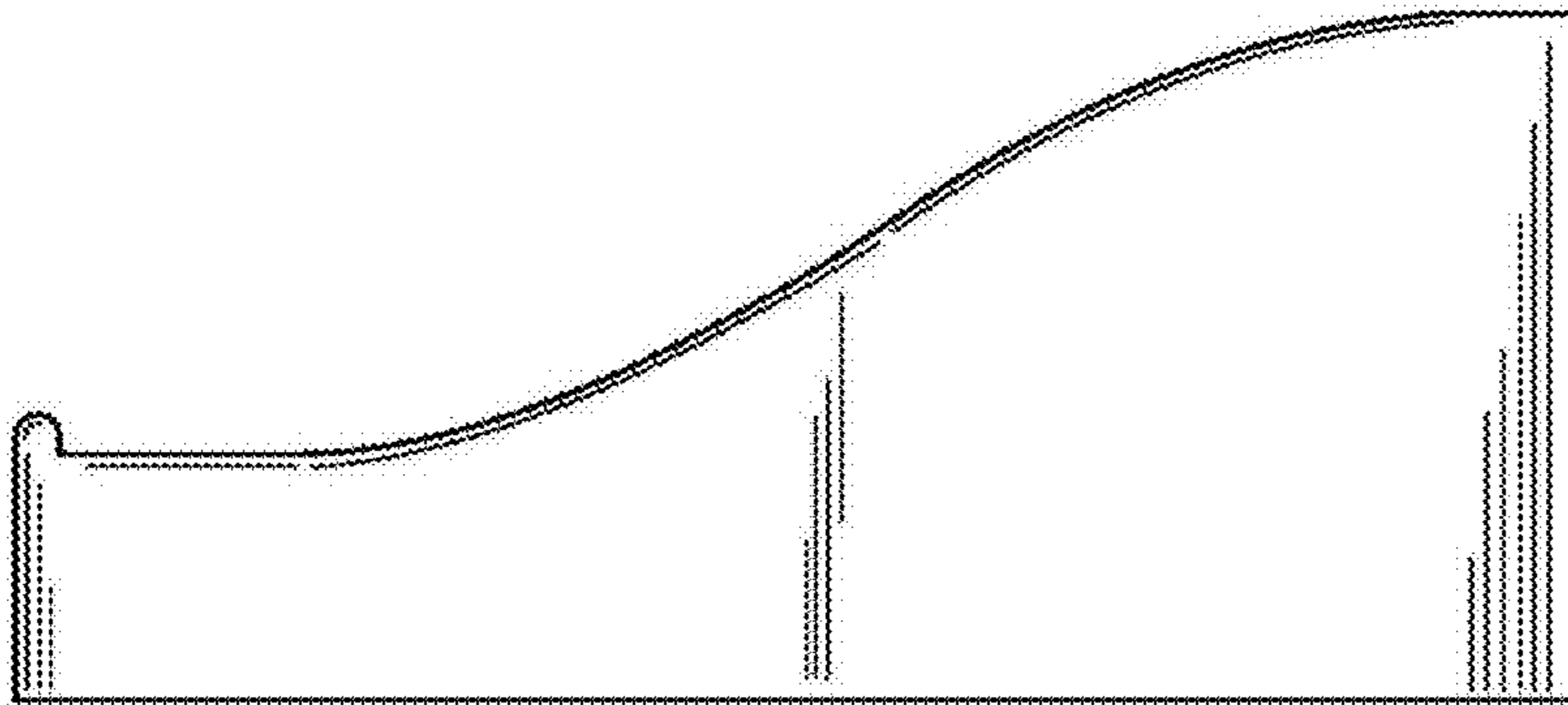

Fig. 12

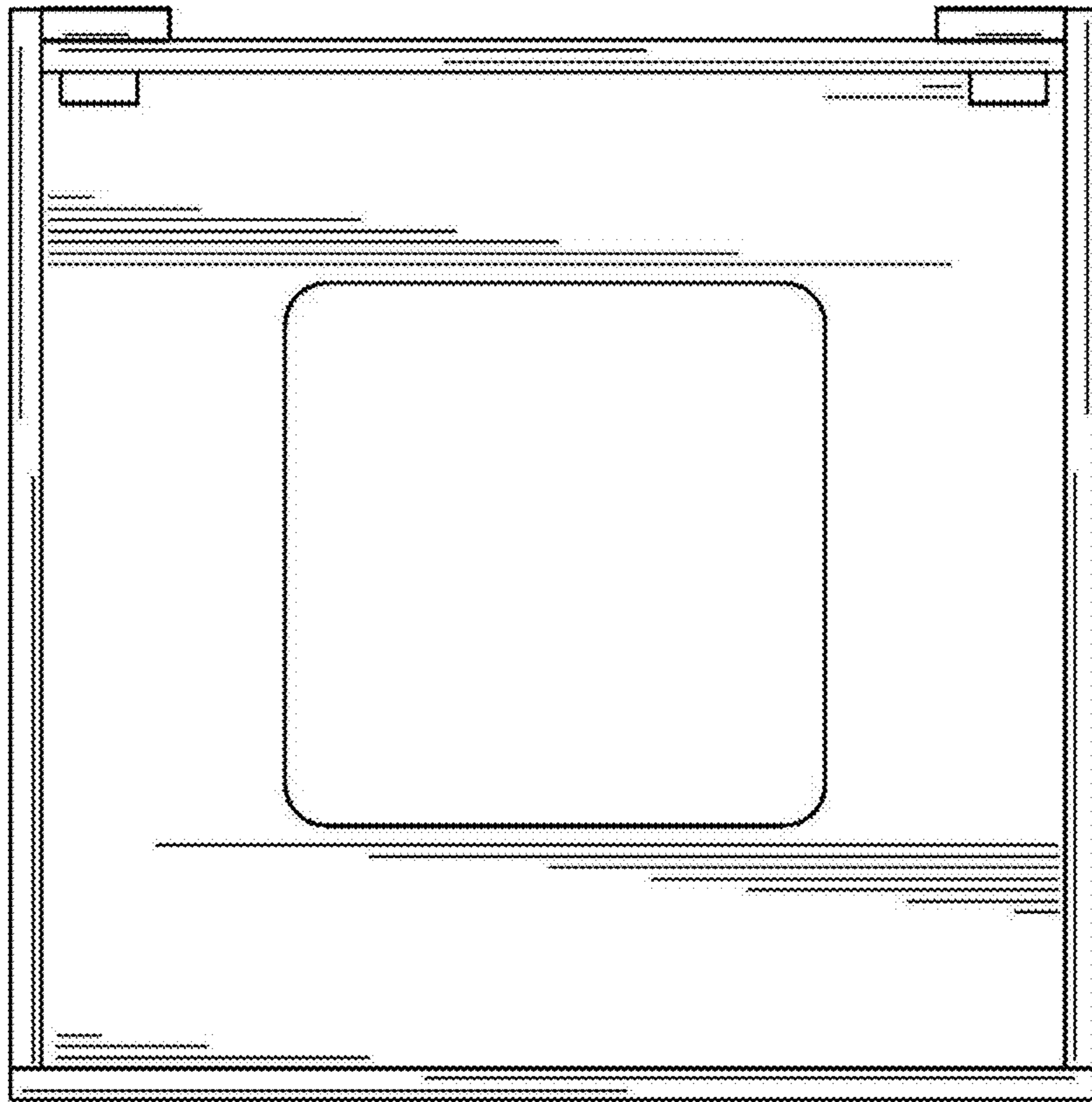

Fig. 13

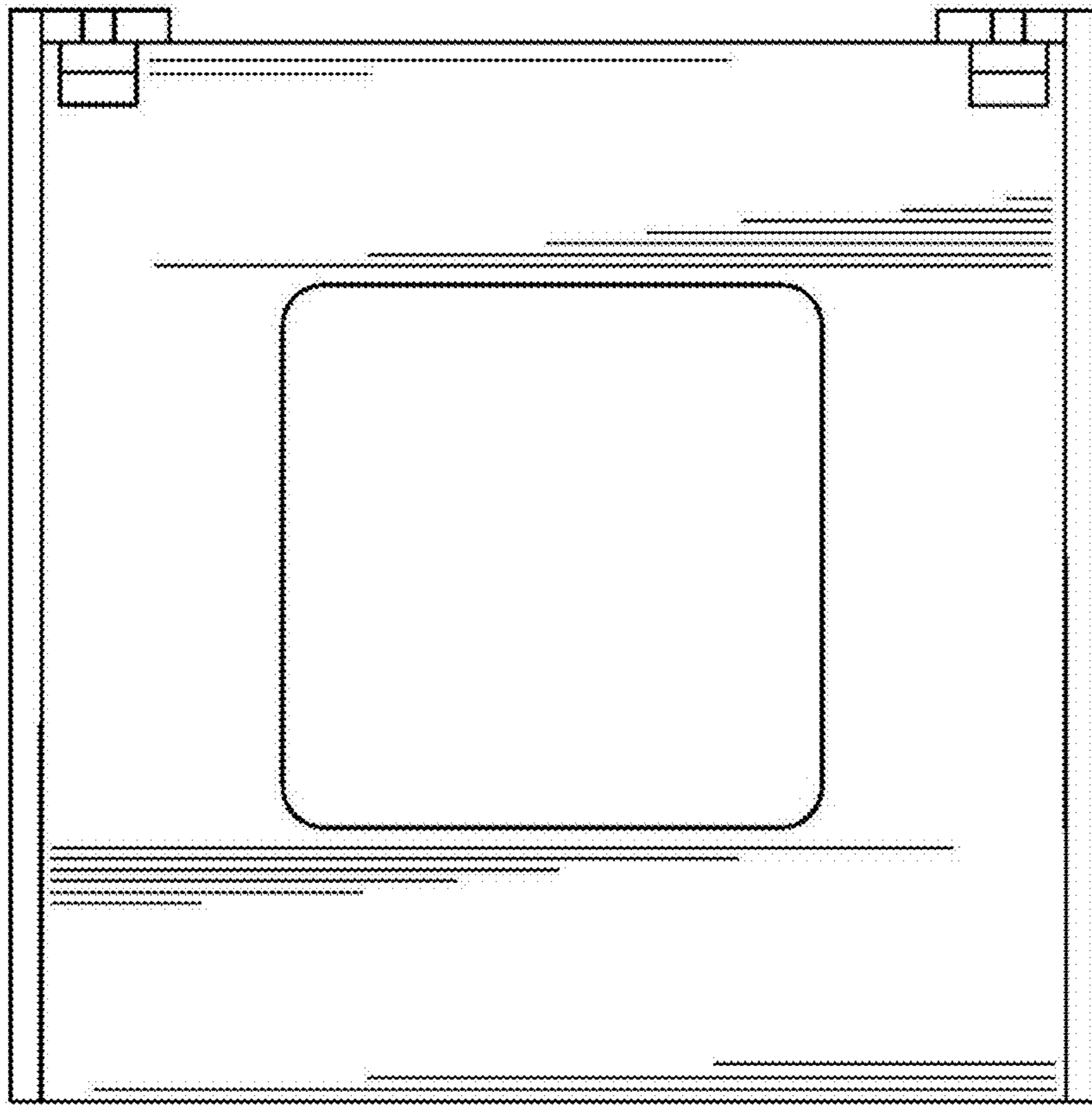

Fig. 14