



US00D833770S

(12) **United States Design Patent**
Thompson

(10) **Patent No.:** **US D833,770 S**

(45) **Date of Patent:** **** *Nov. 20, 2018**

(54) **SANITIZING TOOTHBRUSH CABINET**

4,929,039 A * 5/1990 Thomas A47K 5/18
312/207

(71) Applicant: **Neida Thompson**, Akron, OH (US)

6,003,964 A * 12/1999 Baker A46B 17/04
312/206

(72) Inventor: **Neida Thompson**, Akron, OH (US)

D695,546 S * 12/2013 Kruger D6/534

(*) Notice: This patent is subject to a terminal disclaimer.

* cited by examiner

(**) Term: **15 Years**

Primary Examiner — Wan Laymon
Assistant Examiner — Mark Booker

(21) Appl. No.: **29/574,527**

(22) Filed: **Aug. 16, 2016**

(51) **LOC (11) Cl.** **23-02**

(52) **U.S. Cl.**
USPC **D6/534**

(58) **Field of Classification Search**

USPC D6/534, 329, 406.3, 553, 559, 561, 634,
D6/659, 660; 312/209, 224–225, 234,
312/242, 245, 206, 207, 213; 206/312,
206/320, 823, 209.1, 210, 369, 581;
222/94, 101

CPC A47B 43/00; A47B 43/04; A47B 47/0066;
A47B 47/04; A47B 63/00; A47B 69/00;
A47B 71/00; A47B 88/00; A47B 46/00;
B65D 51/00; A47K 1/09; A47K 5/18;
A45D 44/18; A61G 15/14; A61G 15/16

See application file for complete search history.

(56) **References Cited**

U.S. PATENT DOCUMENTS

1,529,024 A * 3/1925 Hoch A47K 1/09
206/209.1
2,812,880 A * 11/1957 Altman A47K 1/09
222/101

(57) **CLAIM**

The ornamental design for a sanitizing toothbrush cabinet, as shown and described.

DESCRIPTION

FIG. 1 is a perspective view of the sanitizing toothbrush cabinet showing my new design; FIG. 2 is a front elevation view thereof; FIG. 3 is a rear elevation view thereof; FIG. 4 is a top plan view thereof; FIG. 5 is a bottom plan view thereof; FIG. 6 is a right elevation view thereof; FIG. 7 is a left elevation view thereof; FIG. 8 is a perspective view thereof, with the hinged closure in an alternate position; and, FIG. 9 is a perspective view thereof, with the hinged closure in an alternate position and showing the ultra violet light. Broken lines are included for depicting environmental subject matter and form no part of the claimed design.

1 Claim, 9 Drawing Sheets

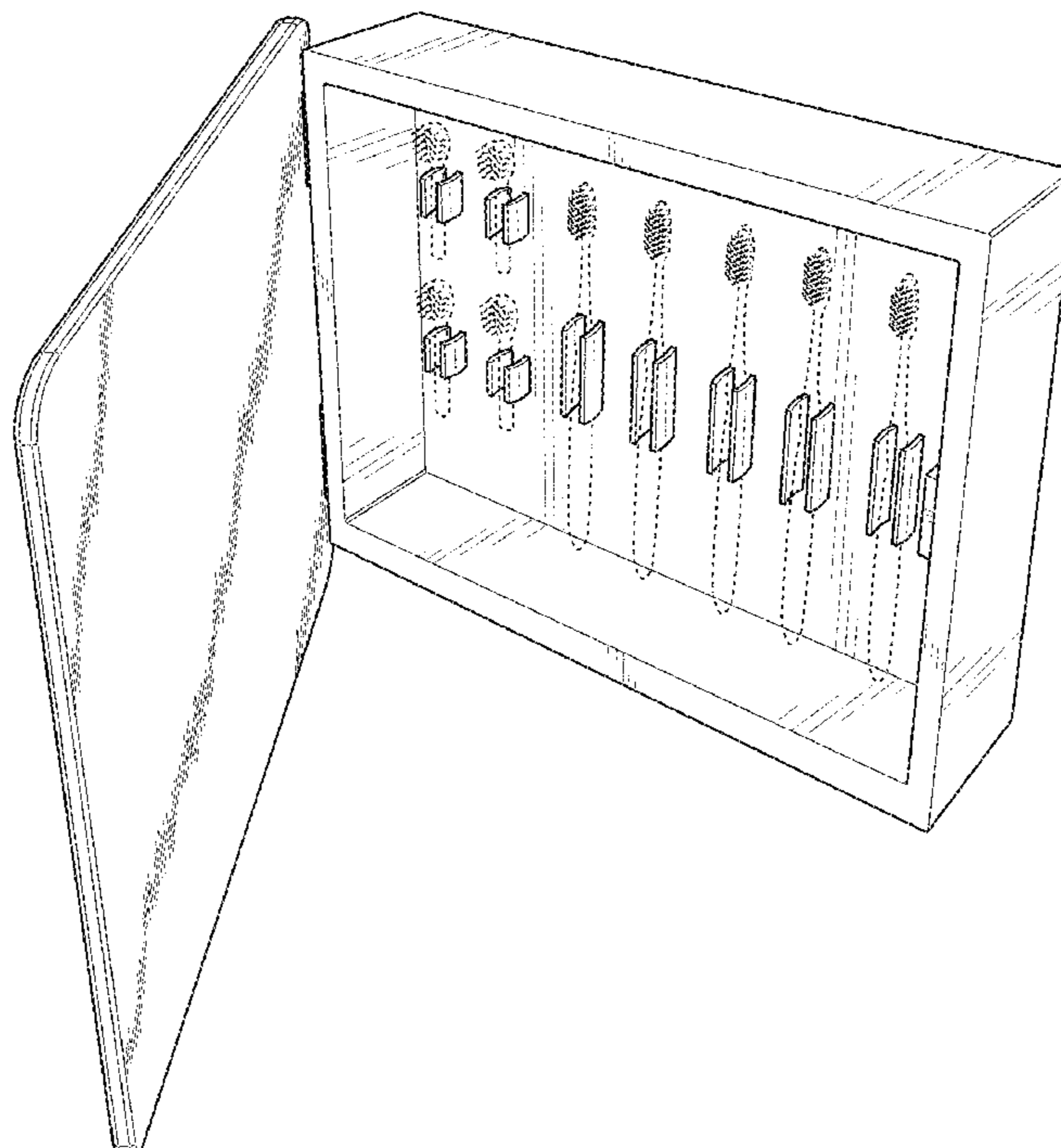

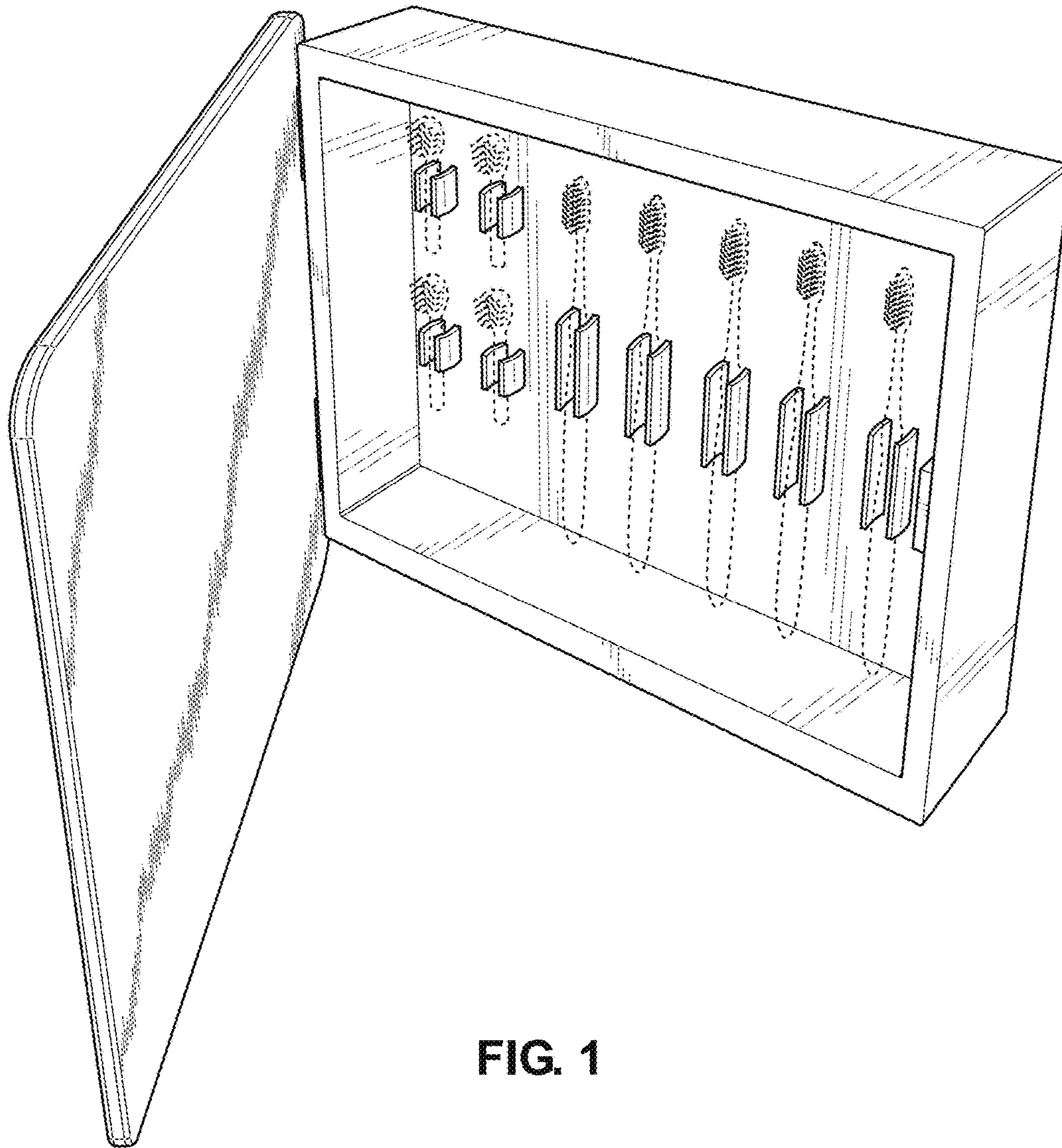

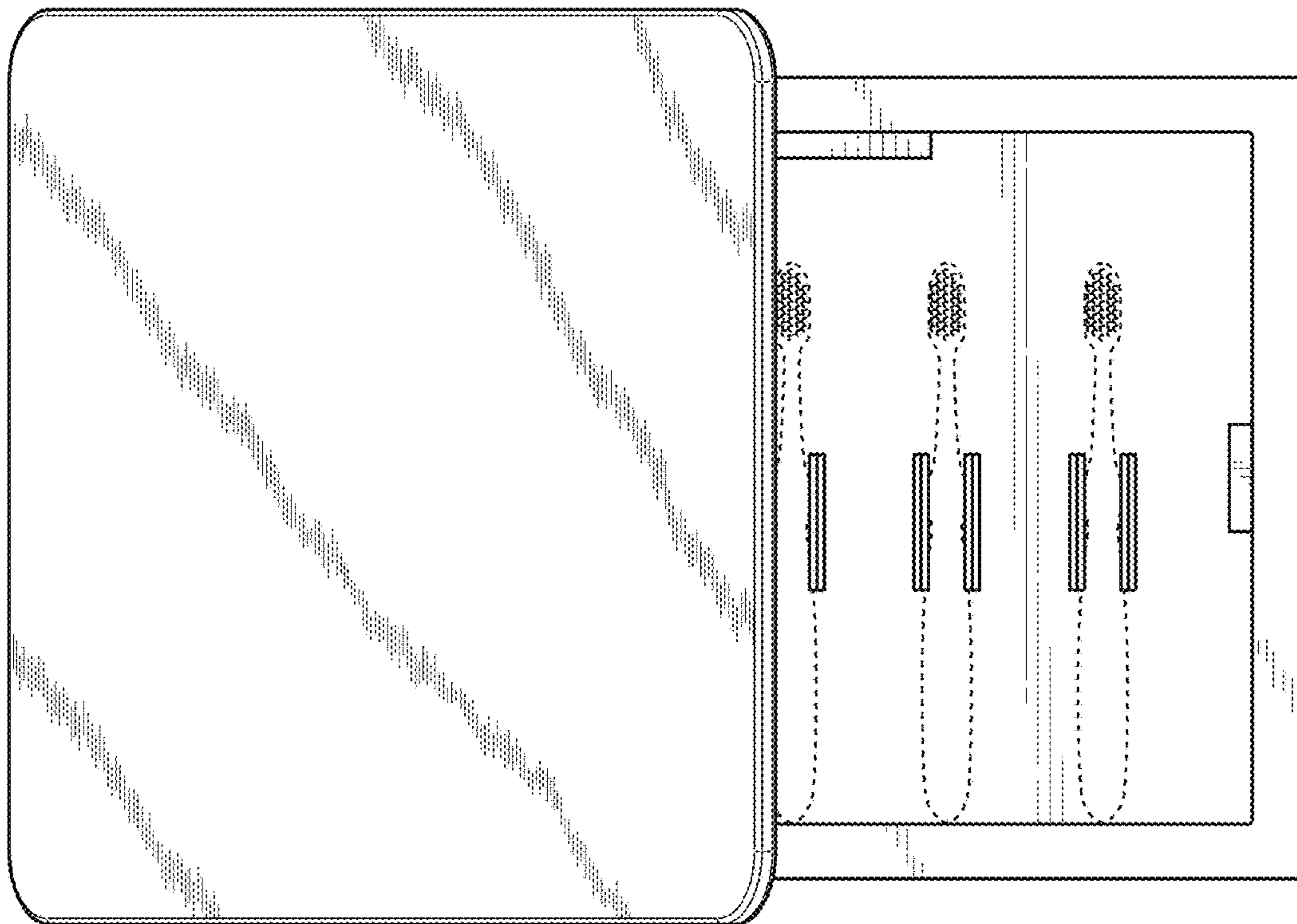

FIG. 2

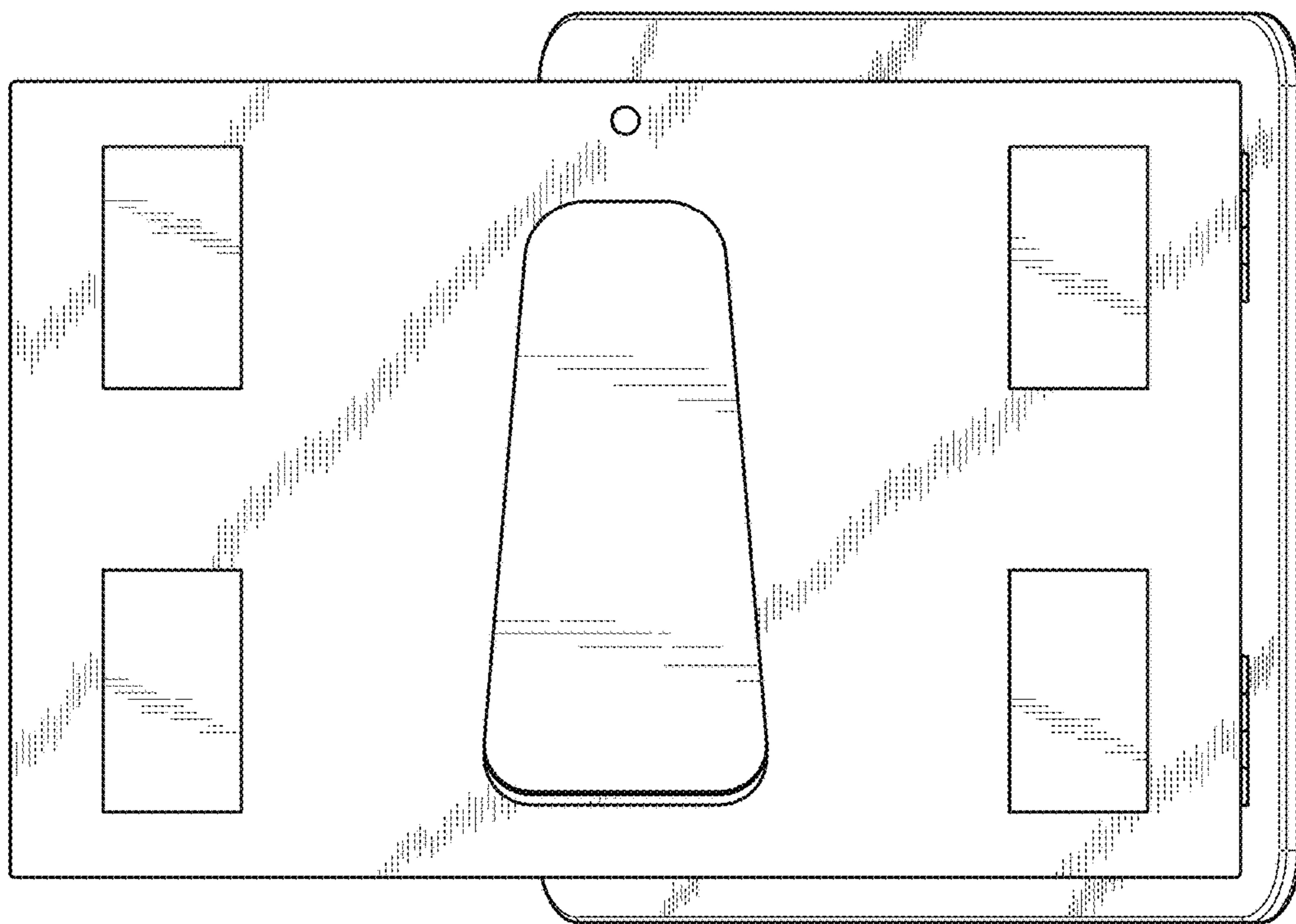

FIG. 3

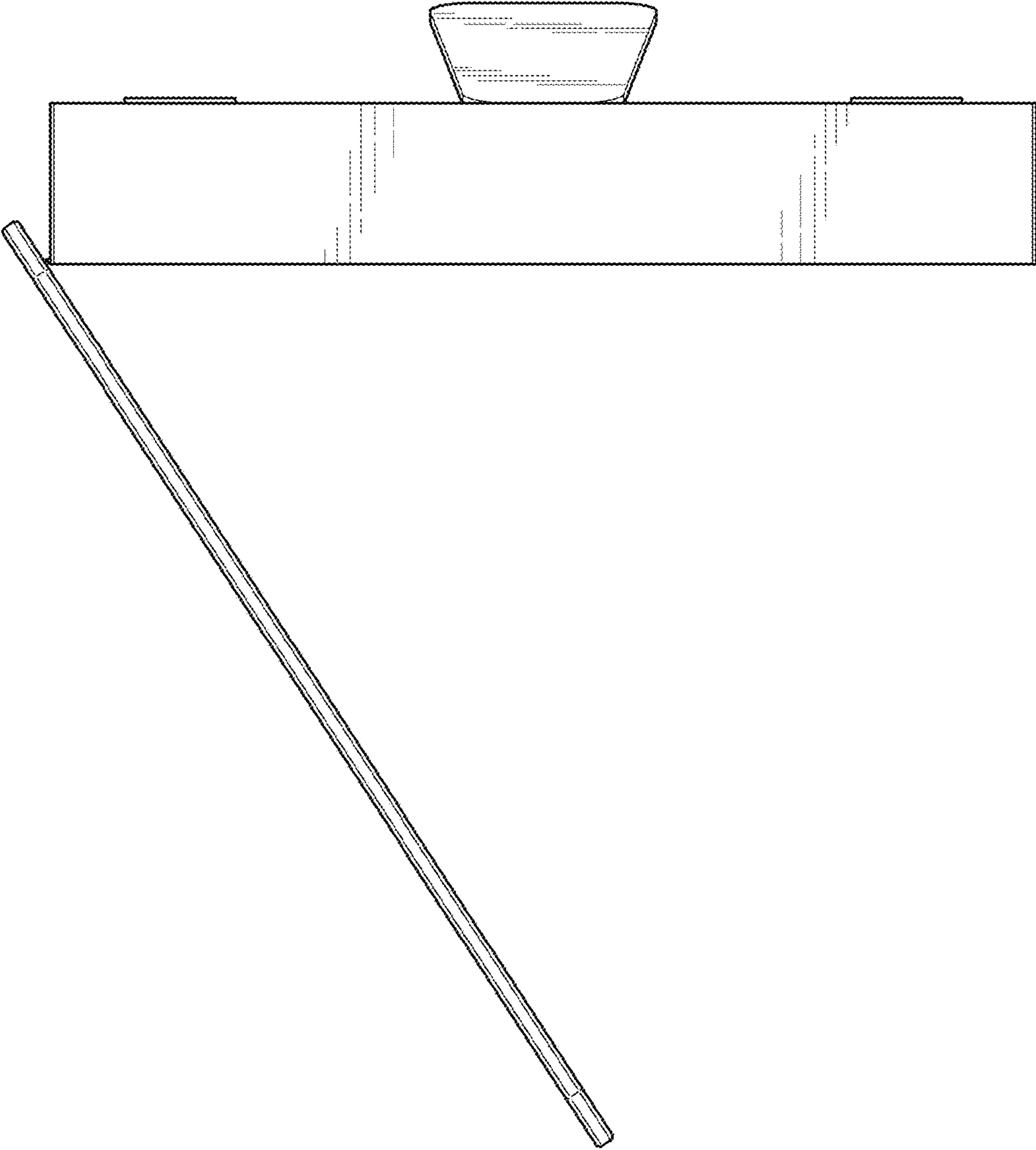

FIG. 4

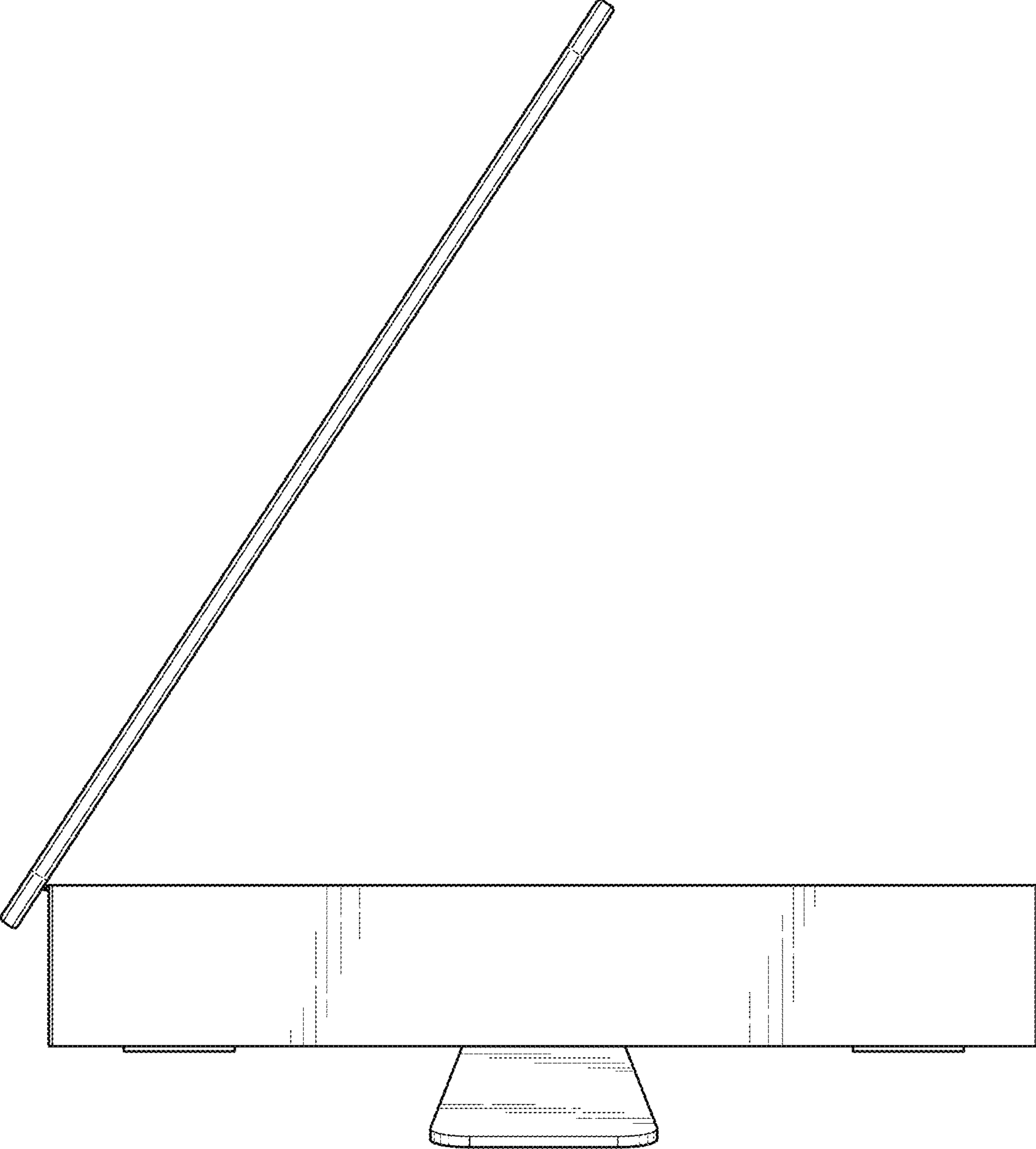

FIG. 5

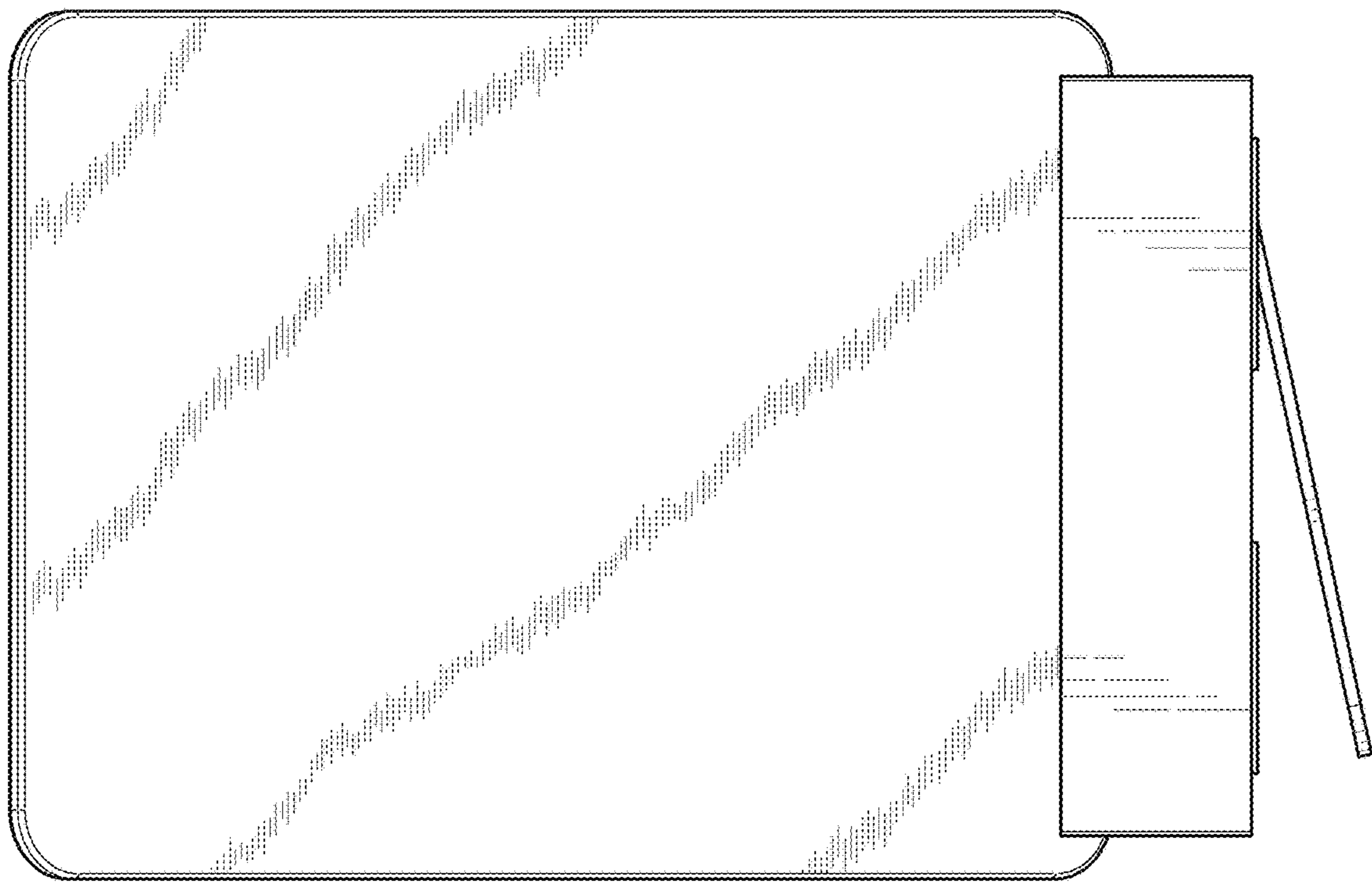

FIG. 6

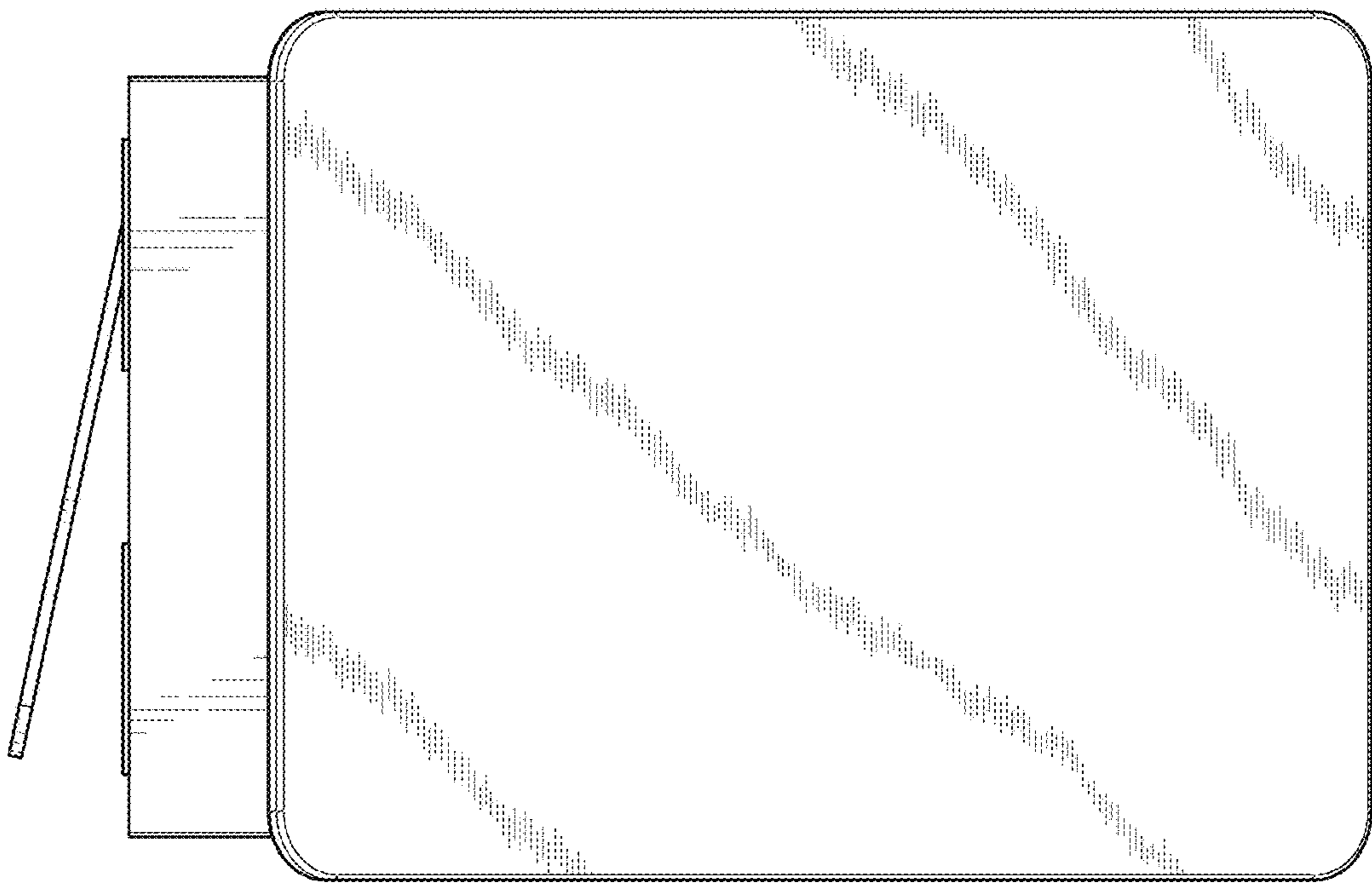

FIG. 7

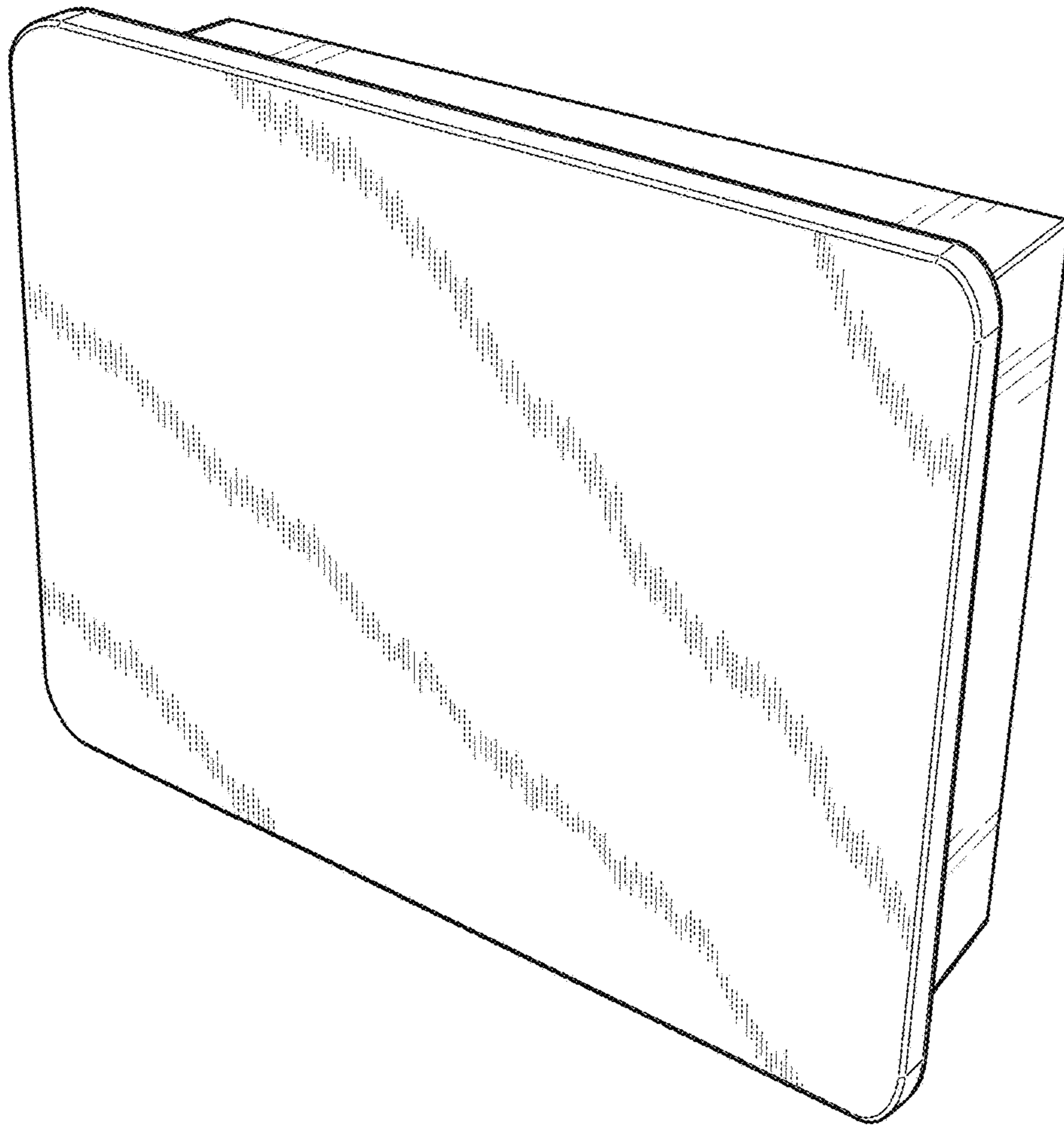

FIG. 8

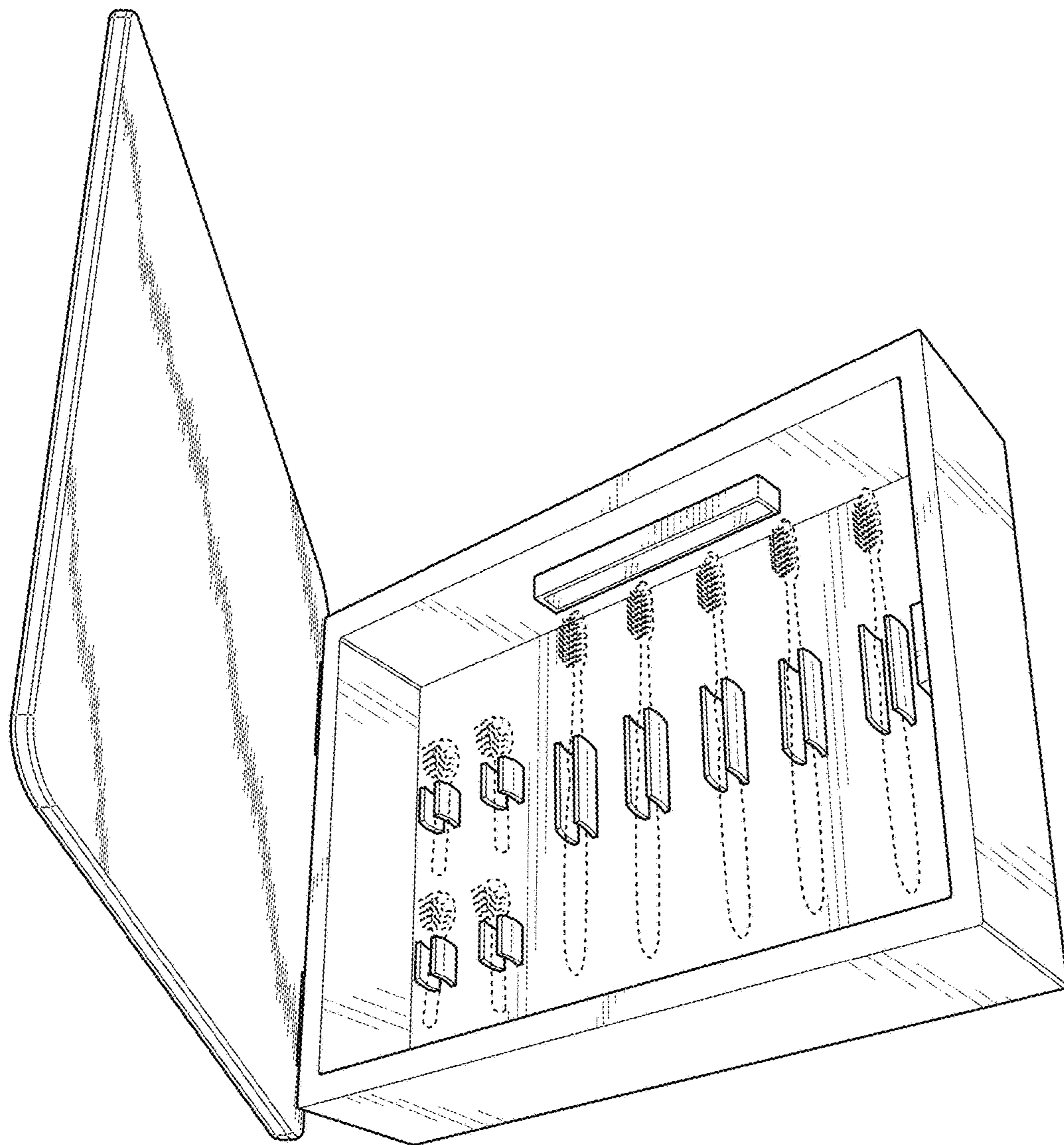

FIG. 9