



US00D833733S

(12) **United States Design Patent**
Chen

(10) **Patent No.:** **US D833,733 S**

(45) **Date of Patent:** **** Nov. 20, 2018**

- (54) **PILL BOX**
- (71) Applicant: **Shenzhen Yuwen E-Commerce Co., Ltd.**, Shenzhen (CN)
- (72) Inventor: **Junyuan Chen**, Shenzhen (CN)
- (73) Assignee: **SHENZHEN YUWEN E-COMMERCE CO., LTD.**, Shenzhen (CN)
- (**) Term: **15 Years**
- (21) Appl. No.: **29/649,216**
- (22) Filed: **May 29, 2018**
- (51) **LOC (11) Cl.** **03-03**
- (52) **U.S. Cl.**
USPC **D3/203.3**
- (58) **Field of Classification Search**
USPC D3/201, 203.1-203.8; D9/420, 421, 757, D9/759
CPC B65D 75/372; B65D 83/0481; B65D 1/36; B65D 83/04; B65D 83/0445; B65D 2583/04; A61J 7/04; A61J 1/03
See application file for complete search history.

- 6,000,546 A * 12/1999 Noble A61J 1/03 206/1.5
- D418,288 S * 1/2000 Priebe D3/201
- D430,392 S * 9/2000 Noble D3/201
- D457,819 S * 5/2002 Noble D10/40
- D466,801 S * 12/2002 Holland D3/203.3
- D528,782 S * 9/2006 Oas D3/203.3
- D541,039 S * 4/2007 Stugelmeyer
- 7,387,207 B2 * 6/2008 Priebe A61J 1/03 206/532
- D587,005 S * 2/2009 Gardner D3/203.3
- 7,494,012 B1 * 2/2009 Priebe A61J 1/03 206/1.5
- 7,798,330 B2 * 9/2010 Noble B65D 83/04 206/1.5
- D627,151 S 11/2010 Young et al.
- D684,355 S * 6/2013 Priebe D3/203.3
- D691,366 S * 10/2013 Muncy D3/203.3
- D695,512 S * 12/2013 Priebe D3/203.3

(Continued)

Primary Examiner — John Windmuller

Assistant Examiner — Steven J Czyz

(57) **CLAIM**

The ornamental design for a pill box, as shown and described.

DESCRIPTION

FIG. 1 is a front right perspective view of a pill box showing my new design;
 FIG. 2 is a bottom perspective view thereof;
 FIG. 3 is a rear right perspective view thereof;
 FIG. 4 is a front elevation view thereof;
 FIG. 5 is a rear elevation view thereof;
 FIG. 6 is a left side elevation view thereof;
 FIG. 7 is a right side elevation view thereof;
 FIG. 8 is a top plan elevation view thereof; and,
 FIG. 9 is a bottom plan elevation view thereof.
 The broken lines depict portions of the article that form no part of the claimed design.

1 Claim, 9 Drawing Sheets

- (56) **References Cited**
U.S. PATENT DOCUMENTS
- D227,552 S * 7/1973 Bridges et al. D3/203.3
- D246,508 S 11/1977 Nudell
- D271,081 S * 10/1983 Noble D3/203.3
- D281,225 S * 11/1985 Leman D3/203.3
- 4,735,318 A * 4/1988 Keffeler A61J 1/03 206/532
- D298,803 S * 12/1988 Ebling D3/203.3
- 4,793,492 A * 12/1988 Halbich A45C 11/24 206/538
- D304,905 S * 12/1989 Zimmerman D3/203.3
- D337,725 S * 7/1993 Bunin D3/203.3
- D415,958 S * 11/1999 Noble D3/203.3

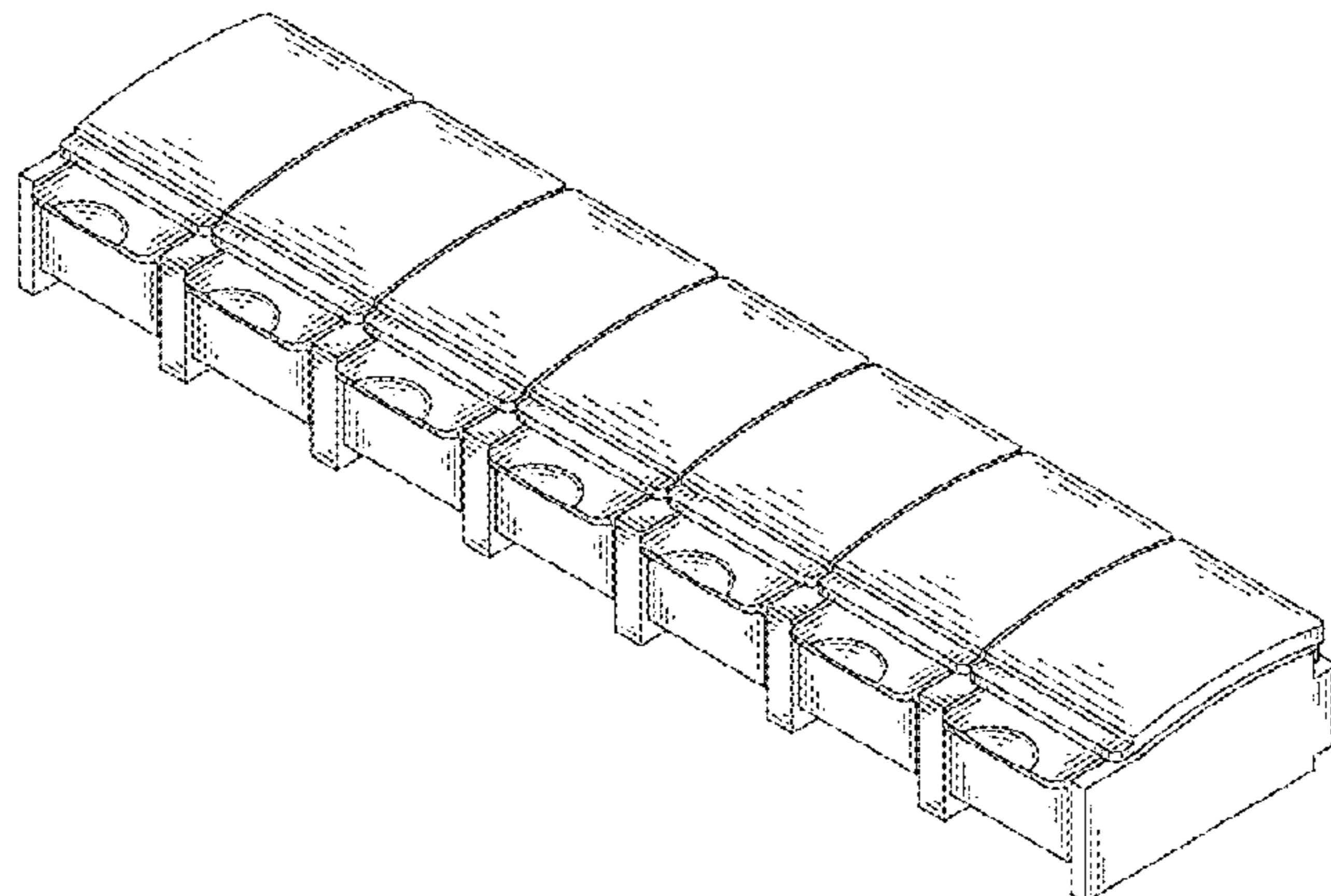

(56)

References Cited

U.S. PATENT DOCUMENTS

D696,008	S	*	12/2013	Priebe	D3/203.3
D696,010	S	*	12/2013	Priebe	D3/203.3
D696,856	S	*	1/2014	Priebe	D3/203.3
D697,303	S	*	1/2014	Priebe	D3/203.3
D698,141	S	*	1/2014	Priebe	D3/203.3
D698,540	S	*	2/2014	Priebe	D3/203.3
D709,282	S	*	7/2014	Priebe	D3/203.3
D747,869	S	*	1/2016	Priebe	D3/203.3
D775,462	S	*	1/2017	Noble	D3/203.3

* cited by examiner

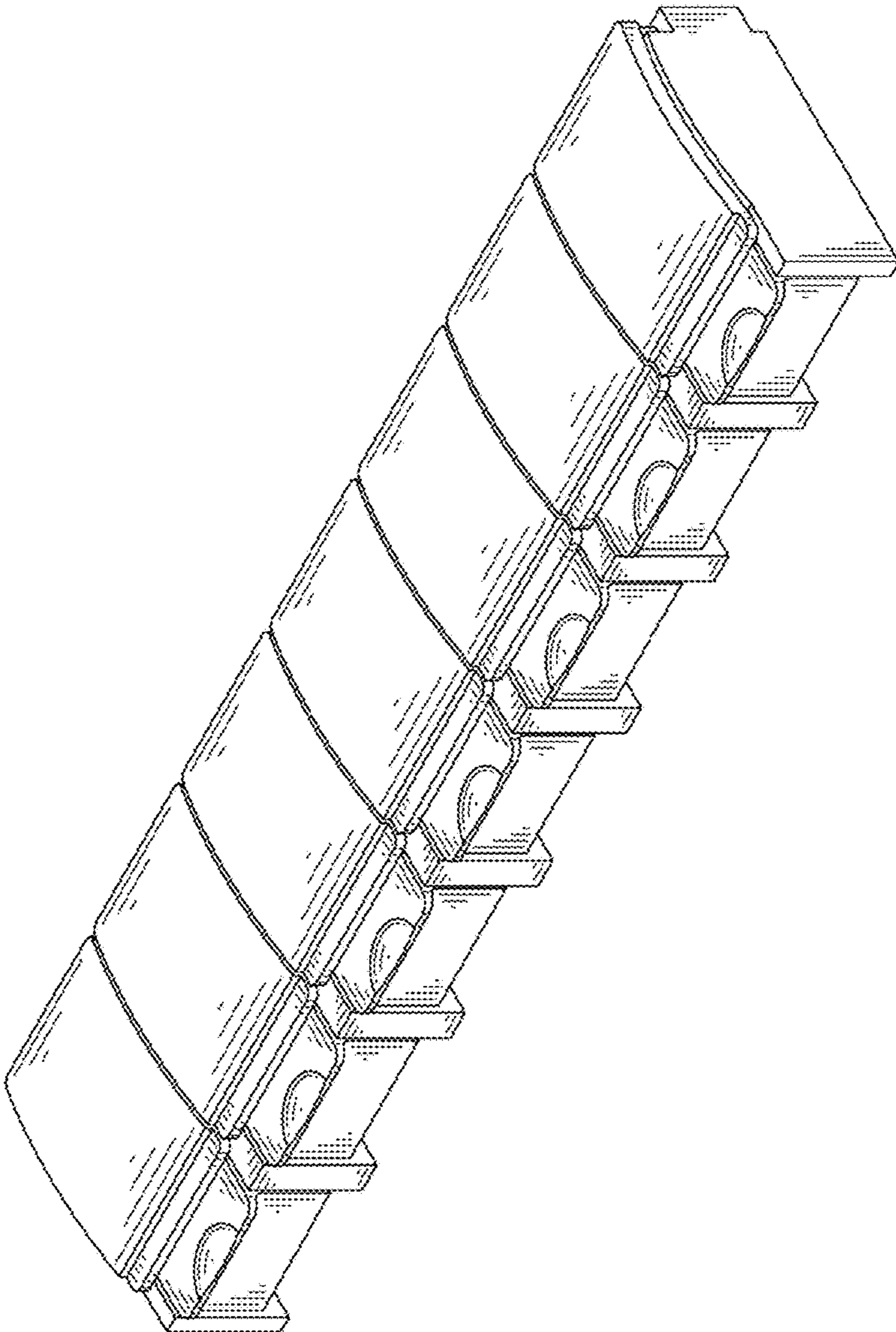

FIG. 1

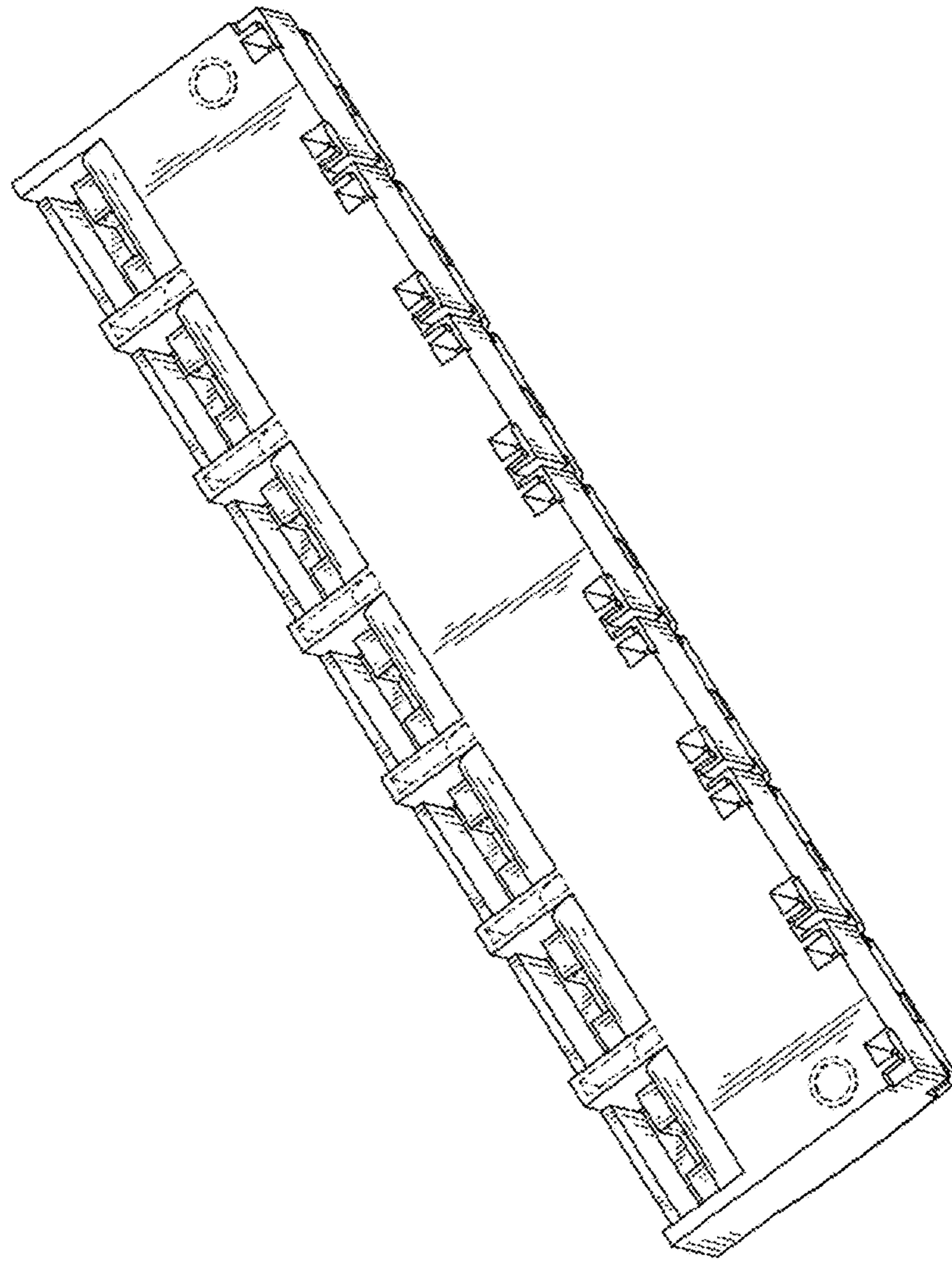

FIG. 2

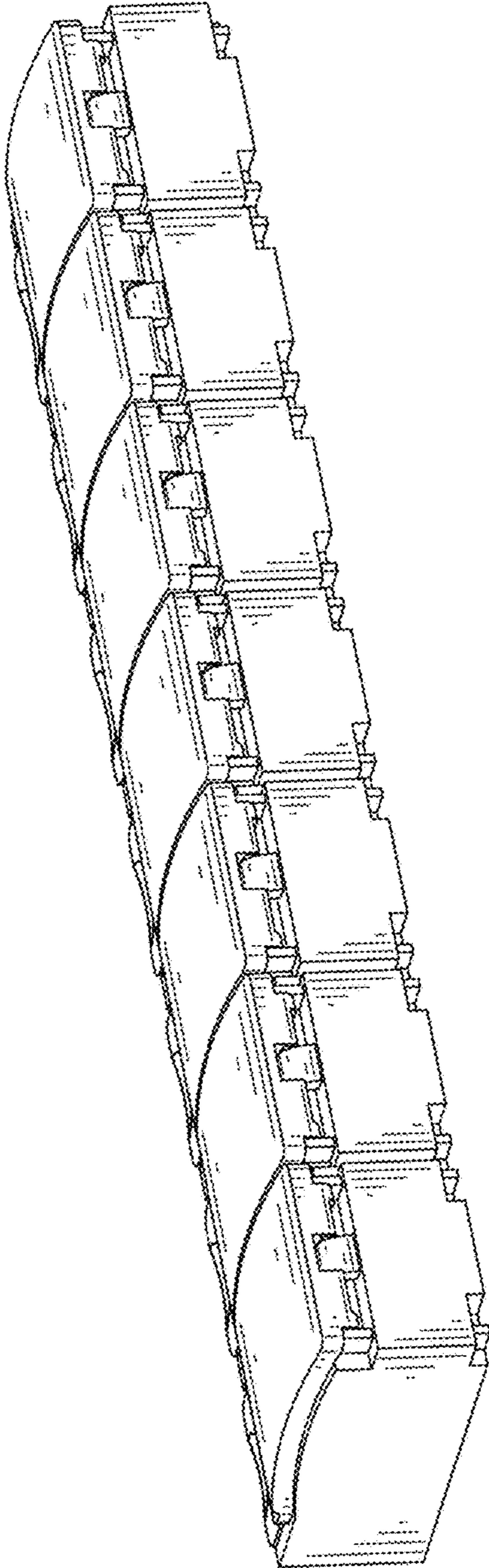

FIG. 3

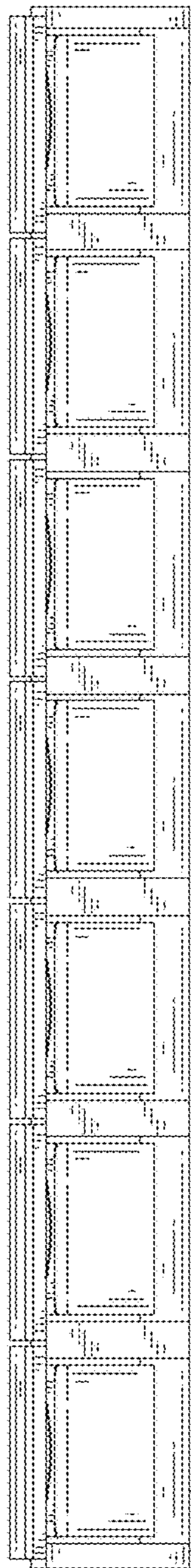

FIG. 4

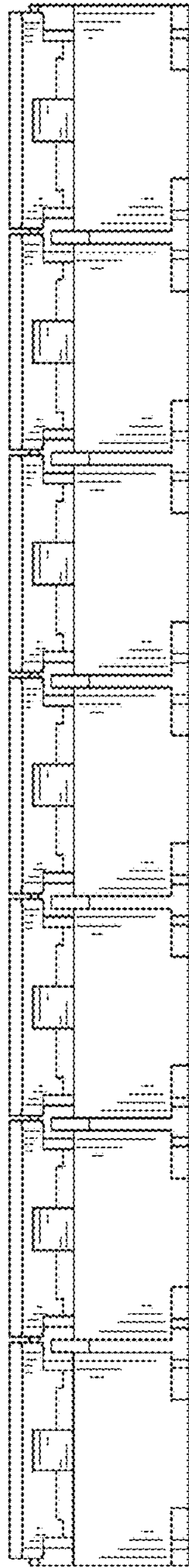

FIG. 5

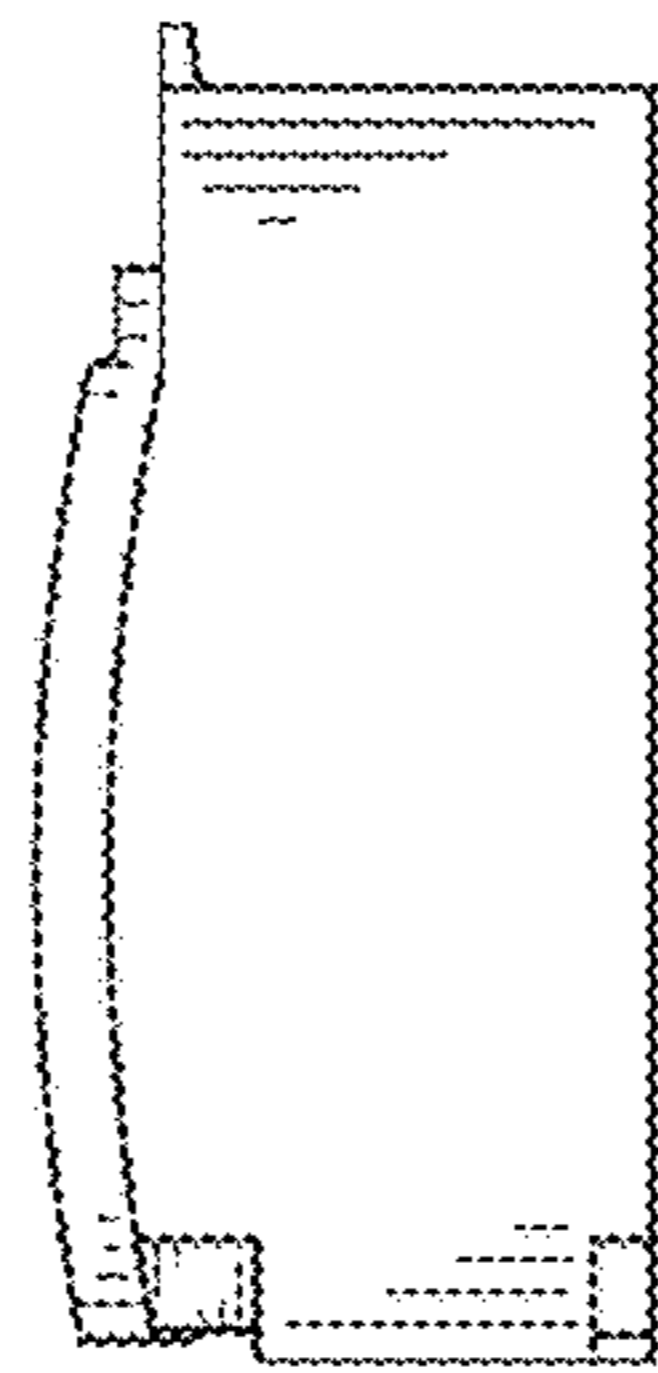

FIG. 6

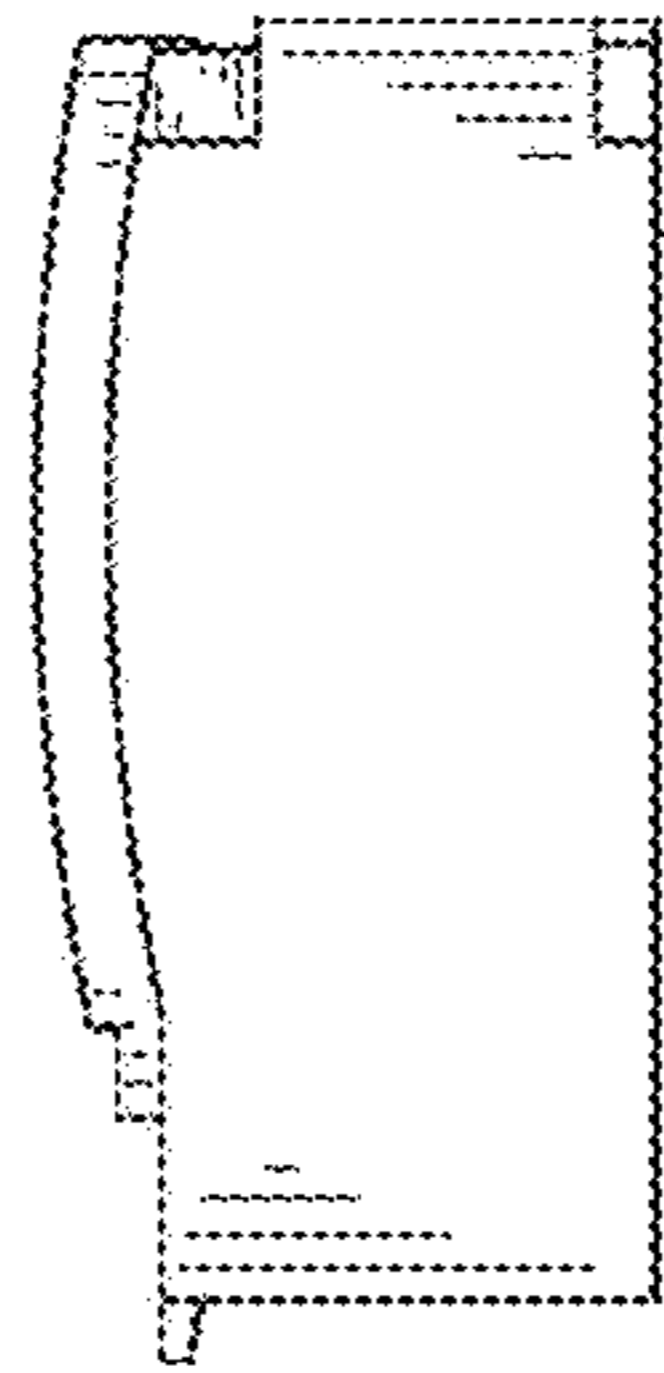

FIG. 7

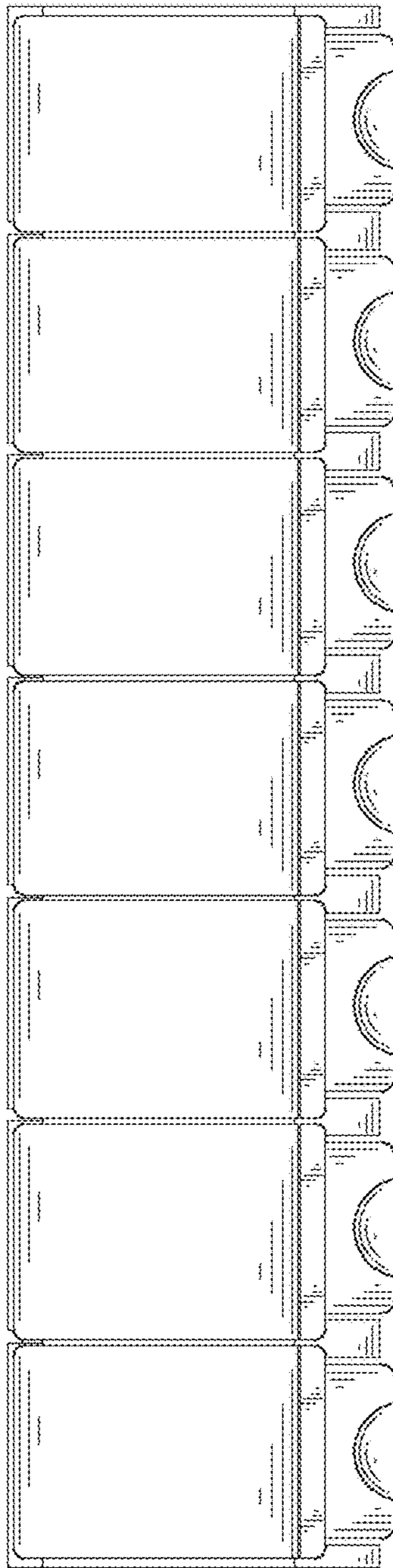

FIG. 8

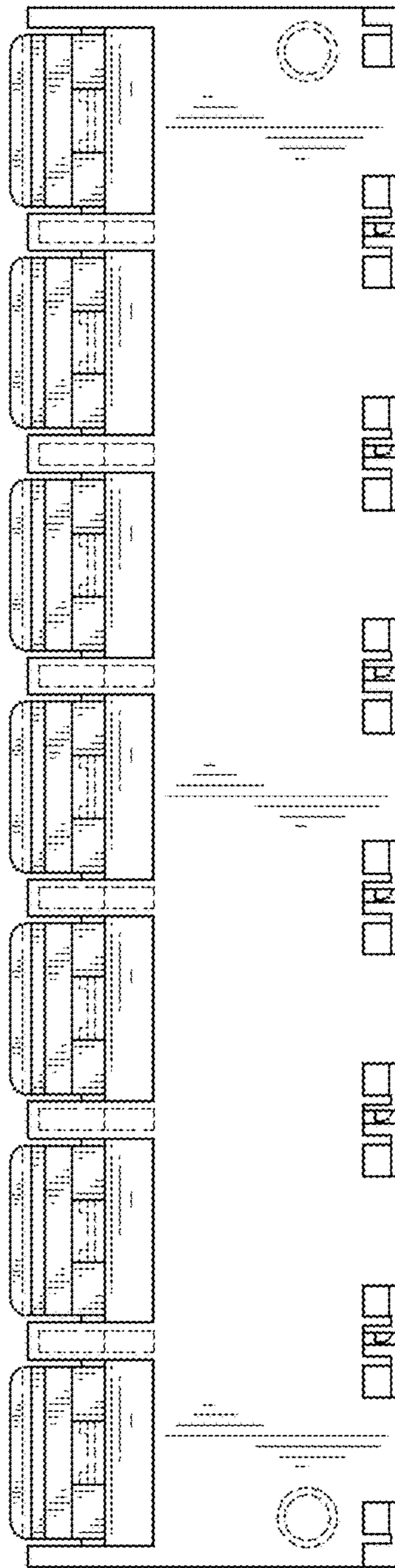

FIG. 9