



US00D833623S

(12) **United States Design Patent** (10) **Patent No.:** **US D833,623 S**
Naber et al. (45) **Date of Patent:** **** Nov. 13, 2018**

- (54) **COT FASTENER**
- (71) Applicant: **Stryker Corporation**, Kalamazoo, MI (US)
- (72) Inventors: **Brandon David Naber**, Portage, MI (US); **Jason James Wroblewski**, Kalamazoo, MI (US); **Clifford Edwin Lambarth**, Portage, MI (US)
- (73) Assignee: **Stryker Corporation**, Kalamazoo, MI (US)
- (**) Term: **15 Years**
- (21) Appl. No.: **29/613,059**
- (22) Filed: **Aug. 7, 2017**
Related U.S. Application Data
- (63) Continuation of application No. 29/536,593, filed on Aug. 18, 2015, now Pat. No. Des. 794,205.
- (51) **LOC (11) Cl.** **24-01**
- (52) **U.S. Cl.**
USPC **D24/184; D12/14**
- (58) **Field of Classification Search**
USPC D24/183-184; D12/14, 133, 162, 223, D12/406
CPC ... A61G 1/02; A61G 1/04; A61G 1/06; A61G 1/048; A61G 1/013; A61G 1/0212; A61G 1/0237; A61G 1/0262; A61G 1/0293; A61G 1/0567; A61G 3/001; A61G 3/003; A61G 3/02; A61G 3/0236; A61G 3/0245; A61G 3/0254; A61G 3/0272; A61G 3/029; A61G 3/0816; A61G 3/0833; A61G 3/0875; A61G 3/0883; A61G 3/0891; B60N 2/0742; B60N 2/0745; B60N 2/12
See application file for complete search history.

- 5,092,722 A 3/1992 Reazer, III et al.
- 5,205,601 A 4/1993 Ferris
- 5,913,559 A 6/1999 Sexton et al.
- 7,287,794 B2 10/2007 Bourgraf, Jr. et al.
- 7,478,855 B2* 1/2009 Lambarth A61G 3/0254 296/19

(Continued)

FOREIGN PATENT DOCUMENTS

- GB 2297730 A 8/1996
- WO 2014123692 A1 8/2014
- WO 2014124471 A1 8/2014

OTHER PUBLICATIONS

Stryker Corporation Power-Load TM Power-Loading Cot Fastener System Brochure, dated 2011.

Primary Examiner — Vy N Koenig

(74) *Attorney, Agent, or Firm* — Warner, Norcross + Judd LLP

(57) **CLAIM**

The ornamental design for a cot fastener, as shown and described.

DESCRIPTION

FIG. 1 is a perspective view of a cot fastener;
 FIG. 2 is a front elevation view thereof;
 FIG. 3 is a left side elevation view thereof;
 FIG. 4 is a rear elevation view thereof;
 FIG. 5 is a right side elevation view thereof;
 FIG. 6 is a top plan view thereof; and,
 FIG. 7 is a bottom plan view thereof.
 The broken lines in the drawings represent portions of the cot fastener that form no part of the claimed design.

1 Claim, 4 Drawing Sheets

(56) **References Cited**
U.S. PATENT DOCUMENTS

- 2,558,056 A * 6/1951 Mitchell A61G 3/0891 296/19
- 3,918,554 A * 11/1975 Bourgraf A61G 1/0212 296/19

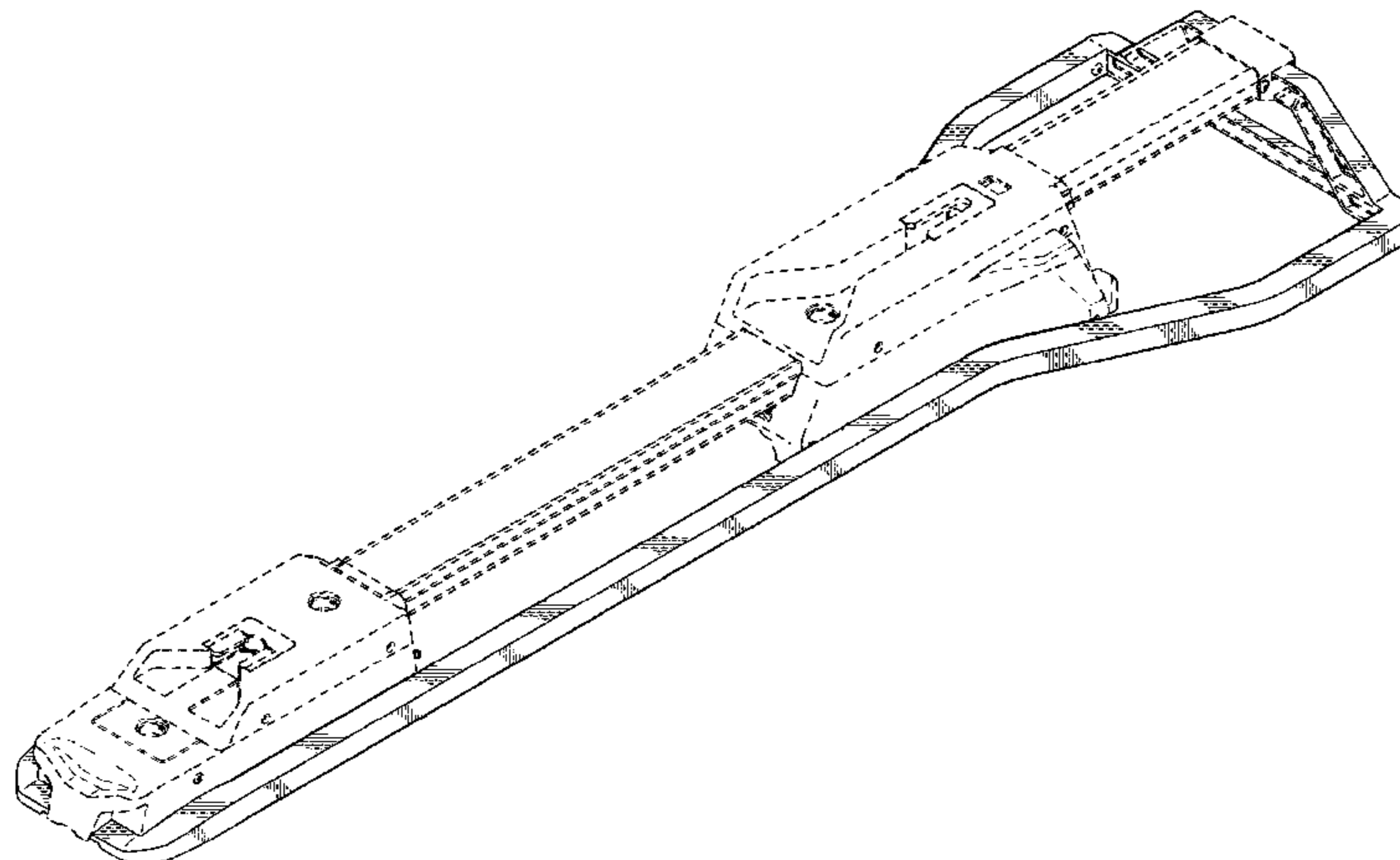

(56)

References Cited

U.S. PATENT DOCUMENTS

7,549,690 B2 * 6/2009 Bourgraf A61G 1/06
296/20
D645,967 S * 9/2011 Sharps D24/184
8,056,950 B2 * 11/2011 Souke A61G 3/0816
296/20
8,382,181 B2 * 2/2013 Bourgraf A61G 3/003
296/19
8,439,416 B2 * 5/2013 Lambarth A61G 1/02
296/20
8,444,195 B2 * 5/2013 Bourgraf A61G 3/0891
296/20
RE44,884 E * 5/2014 Lambarth A61G 1/0212
5/611
D753,831 S * 4/2016 Tao D24/184
9,364,376 B2 * 6/2016 Crawford A61G 3/0236
9,456,939 B2 10/2016 Lambarth et al.
9,545,345 B1 * 1/2017 Akers, Jr. A61G 3/0272
D780,929 S * 3/2017 Nurminen D24/184
2017/0035628 A1 * 2/2017 Naber A61G 1/04

* cited by examiner

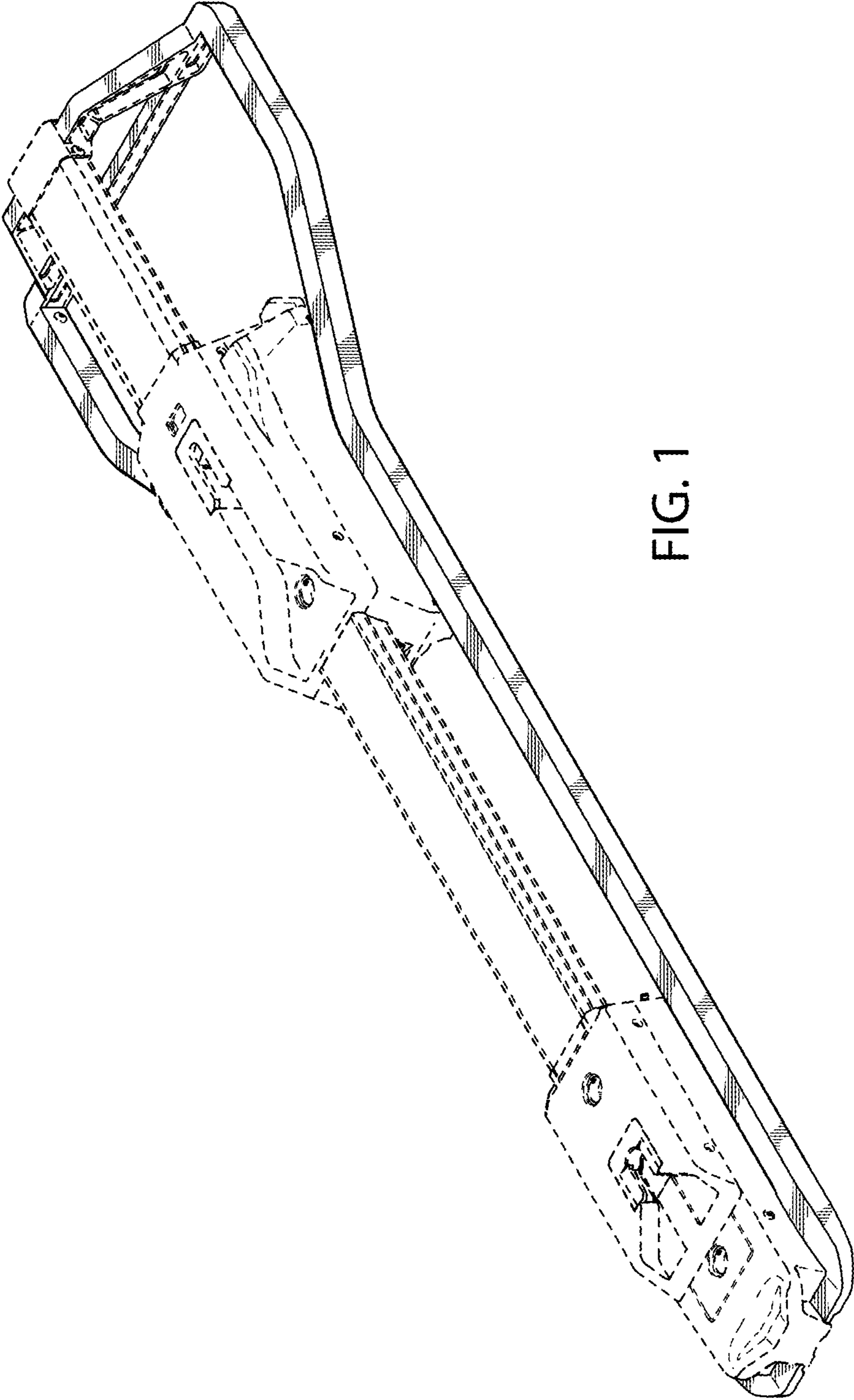

FIG. 1

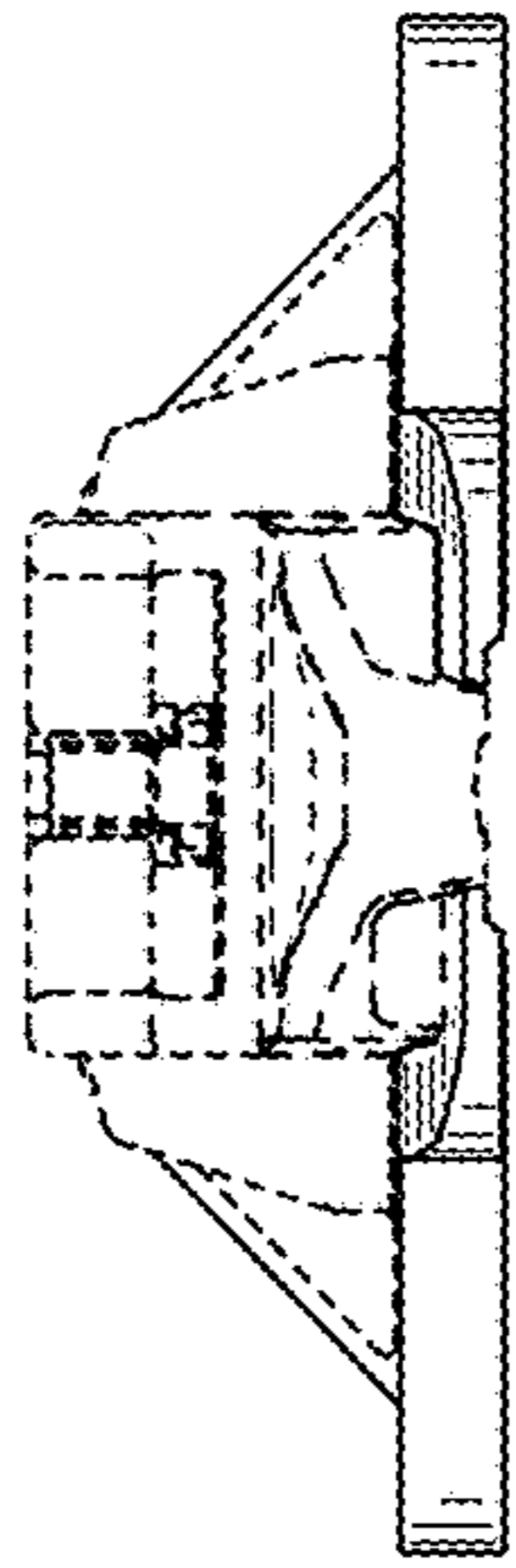

FIG. 2



FIG. 3

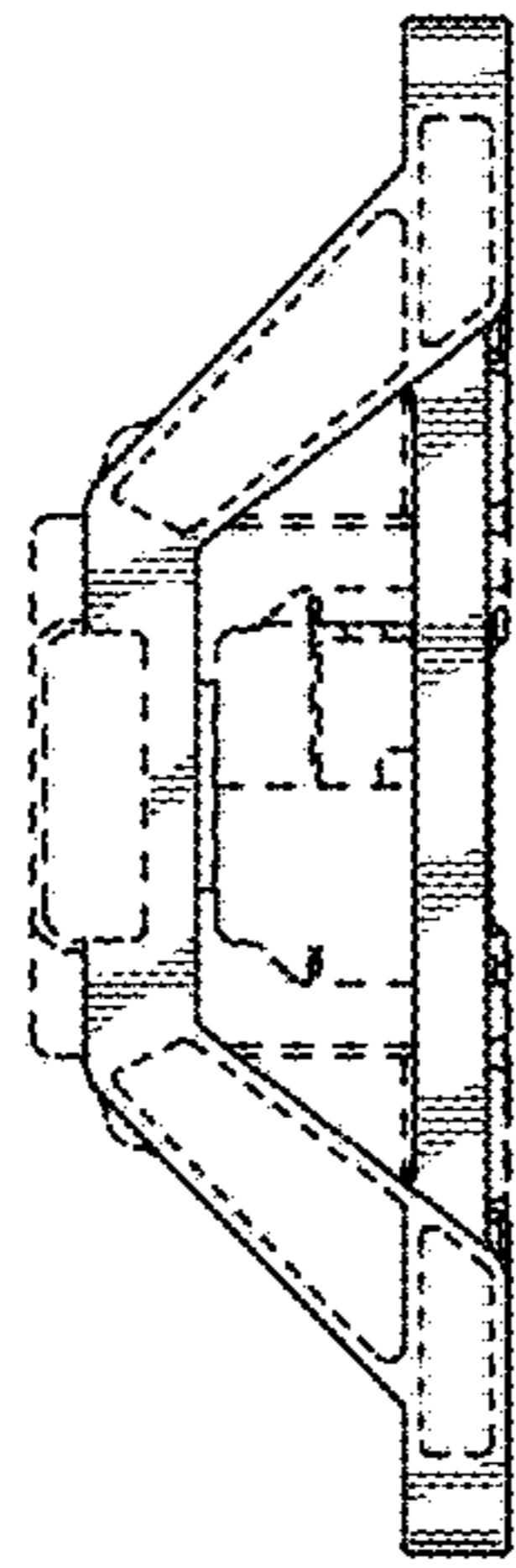

FIG. 4

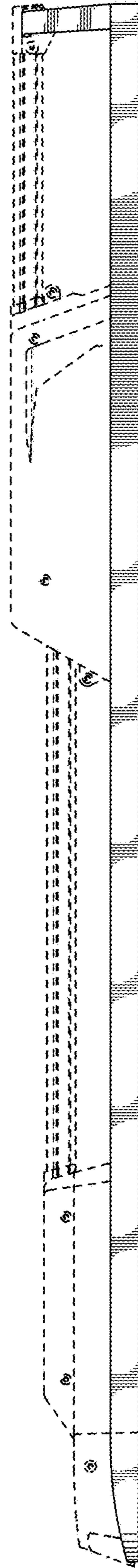

FIG. 5

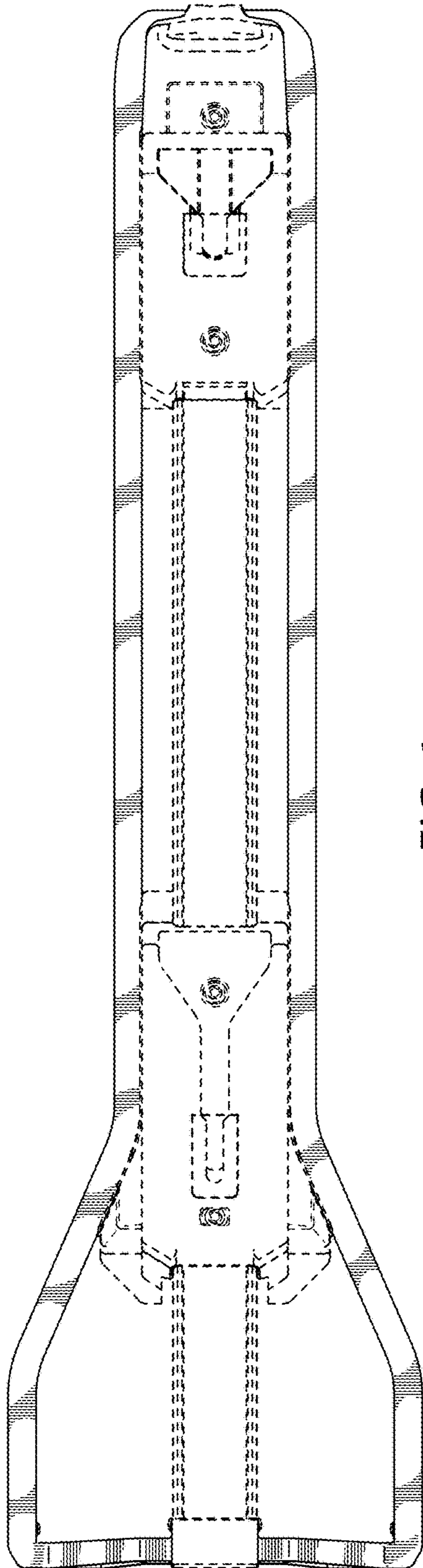

FIG. 6

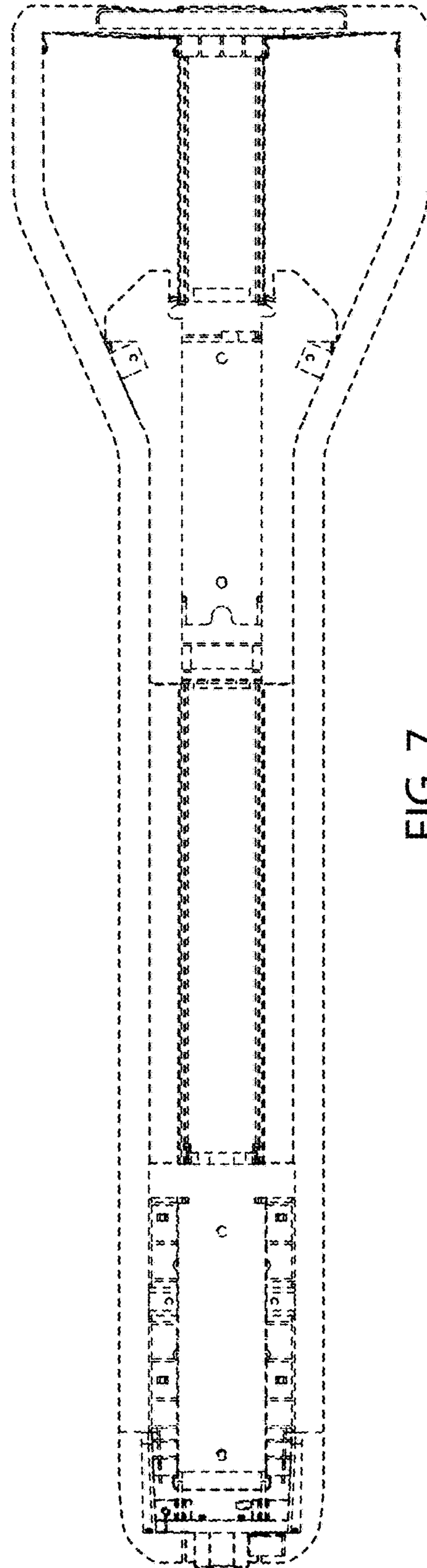

FIG. 7