



US00D833482S

(12) **United States Design Patent** (10) **Patent No.:** **US D833,482 S**  
**McCarthy, Jr. et al.** (45) **Date of Patent:** **\*\* Nov. 13, 2018**

- (54) **ROCKER ARM**
- (71) Applicant: **Eaton Corporation**, Cleveland, OH (US)
- (72) Inventors: **James Edward McCarthy, Jr.**, Kalamazoo, MI (US); **Matthew Vance**, Kalamazoo, MI (US); **Guruprasath Alagarsamy**, Tamil Nadu (IN)
- (73) Assignee: **Eaton Corporation**, Cleveland, OH (US)
- (\*\*) Term: **15 Years**
- (21) Appl. No.: **29/609,402**
- (22) Filed: **Jun. 30, 2017**

- 6,439,179 B2 8/2002 Hendriksma et al.
- 6,467,443 B1 10/2002 Tsuruta et al.
- 6,532,920 B1 3/2003 Sweetnam et al.
- 6,615,782 B1 9/2003 Hendriksma et al.
- 6,640,759 B1 11/2003 Hendriksma
- 6,668,775 B2 12/2003 Harris
- 6,668,779 B2 12/2003 Hendriksma et al.
- 6,691,657 B2 2/2004 Hendriksma et al.
- 6,769,387 B2 8/2004 Hayman et al.
- 6,901,894 B2 6/2005 Haas et al.
- 6,925,978 B1 8/2005 Gerzseny et al.
- 6,948,466 B2 9/2005 Haas et al.
- 6,966,291 B1 11/2005 Fischer et al.
- 6,976,461 B2 12/2005 Rörig et al.
- 6,997,152 B2 2/2006 Harris
- 7,093,572 B2 8/2006 Hendriksma et al.
- 7,174,869 B2 2/2007 Proschko et al.
- 7,240,652 B2 7/2007 Roerig et al.

(Continued)

*Primary Examiner* — T Chase Nelson  
*Assistant Examiner* — Ania Aman  
 (74) *Attorney, Agent, or Firm* — RMCK Law Group PLC

**Related U.S. Application Data**

- (63) Continuation-in-part of application No. 29/532,970, filed on Jul. 13, 2015, now Pat. No. Des. 791,190.
- (51) **LOC (11) Cl.** ..... **15-01**
- (52) **U.S. Cl.**  
USPC ..... **D15/5**
- (58) **Field of Classification Search**  
USPC ..... D15/1-5  
CPC ..... F01L 1/24; F01L 1/18; F01L 1/053; F01L 1/185; F01L 2001/186; F01L 2001/187; F01L 2001/188; F01L 1/181; F01L 1/182  
See application file for complete search history.

(57) **CLAIM**

The ornamental design for a rocker arm, as shown and described.

**DESCRIPTION**

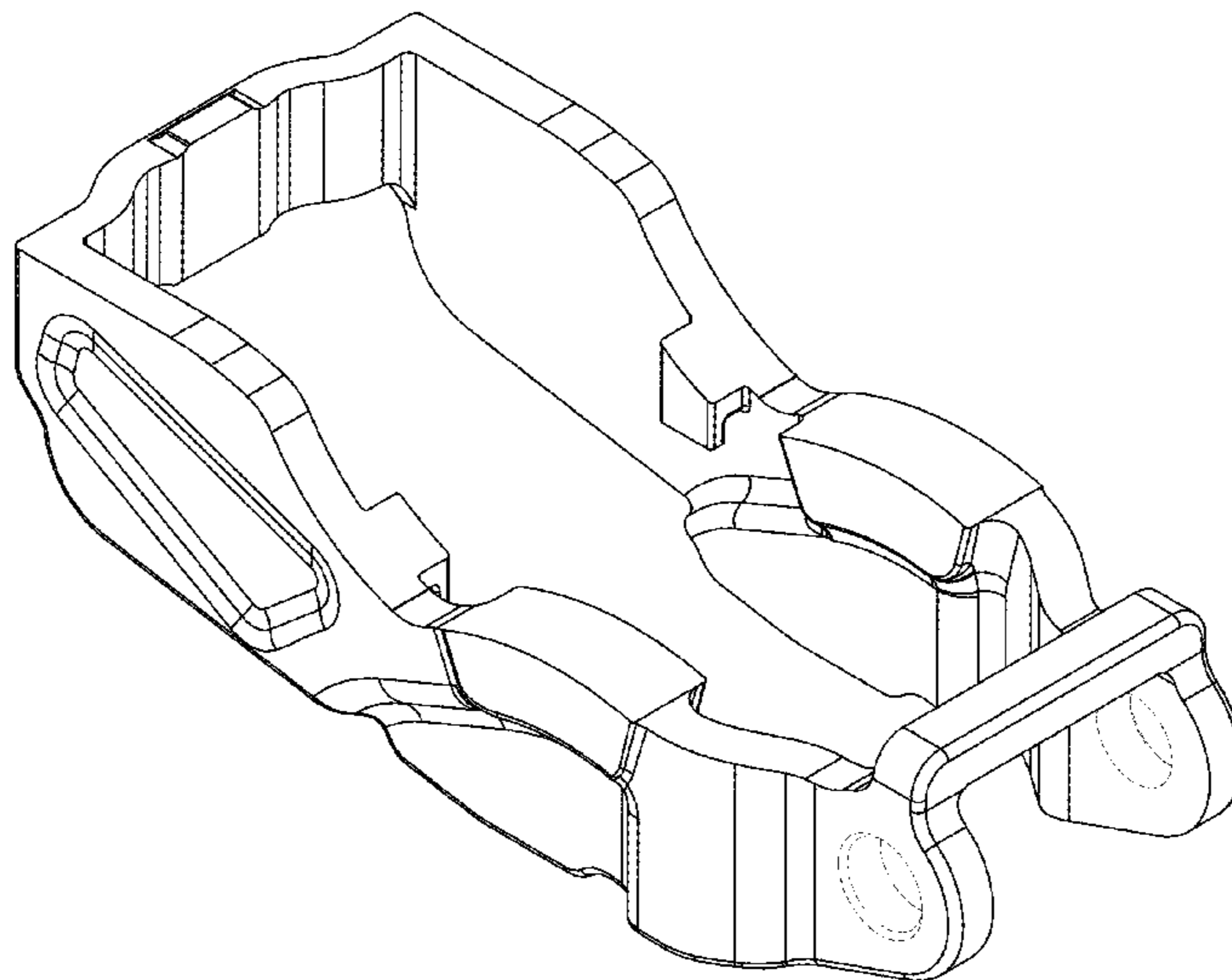
FIG. 1 is a first perspective view of a rocker arm showing the new design.  
 FIG. 2 is a second perspective view of the rocker arm of FIG. 1.  
 FIG. 3 is a top view of the rocker arm of FIG. 1.  
 FIG. 4 is a bottom view of the rocker arm of FIG. 1.  
 FIG. 5 is a first side view of the rocker arm of FIG. 1.  
 FIG. 6 is a second side view of the rocker arm of FIG. 1.  
 FIG. 7 is a first end view of the rocker arm of FIG. 1; and, FIG. 8 is a second end view of the rocker arm of FIG. 1.  
 The broken line showing portions of the rocker arm form no part of the claimed design.

(56) **References Cited**

**U.S. PATENT DOCUMENTS**

- 5,452,694 A 9/1995 Hara
- 5,544,626 A 8/1996 Diggs et al.
- 5,584,267 A 12/1996 Muir
- 6,314,926 B1 11/2001 Meneely et al.
- 6,321,705 B1 11/2001 Fernandez et al.

**1 Claim, 7 Drawing Sheets**



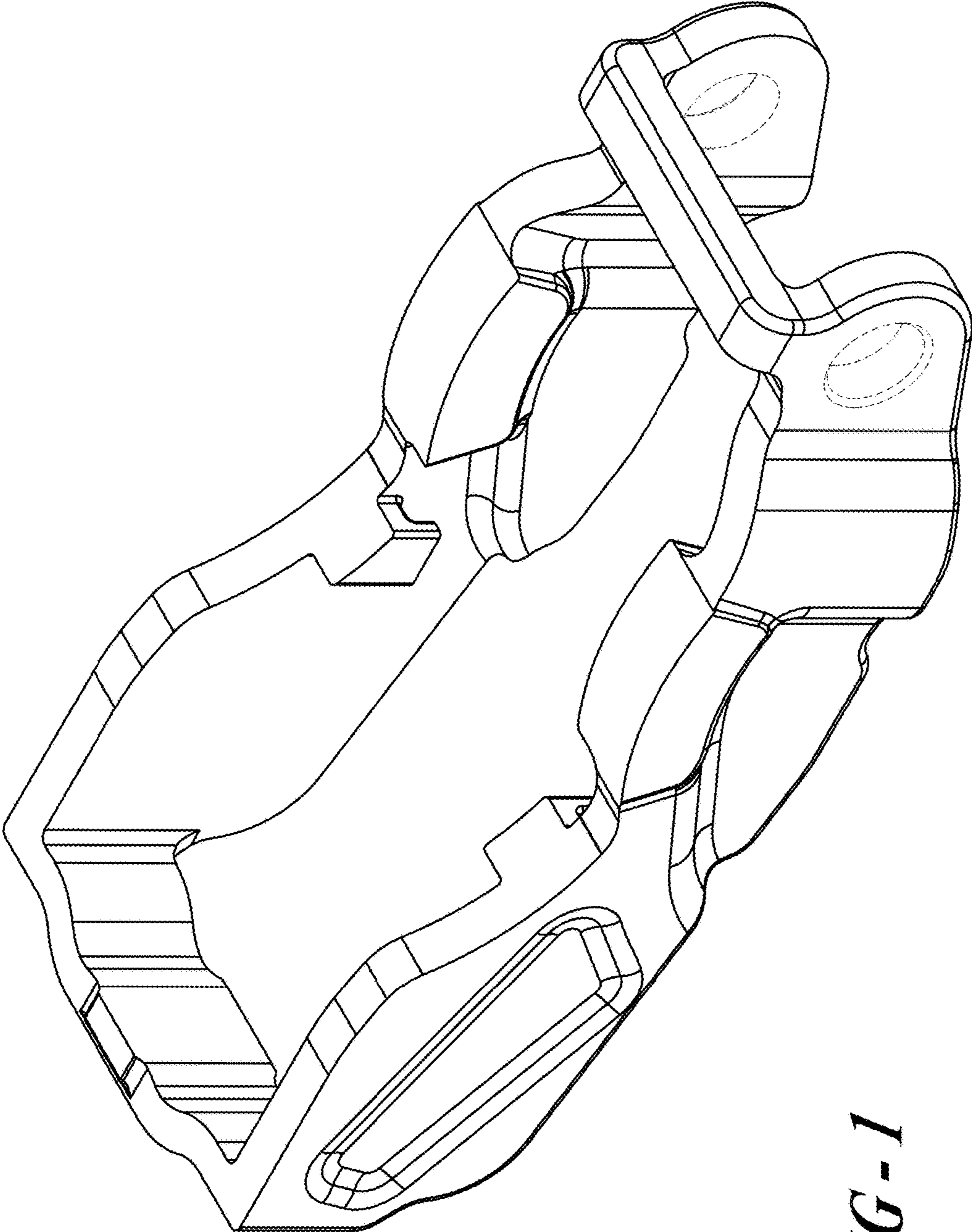
(56)

References Cited

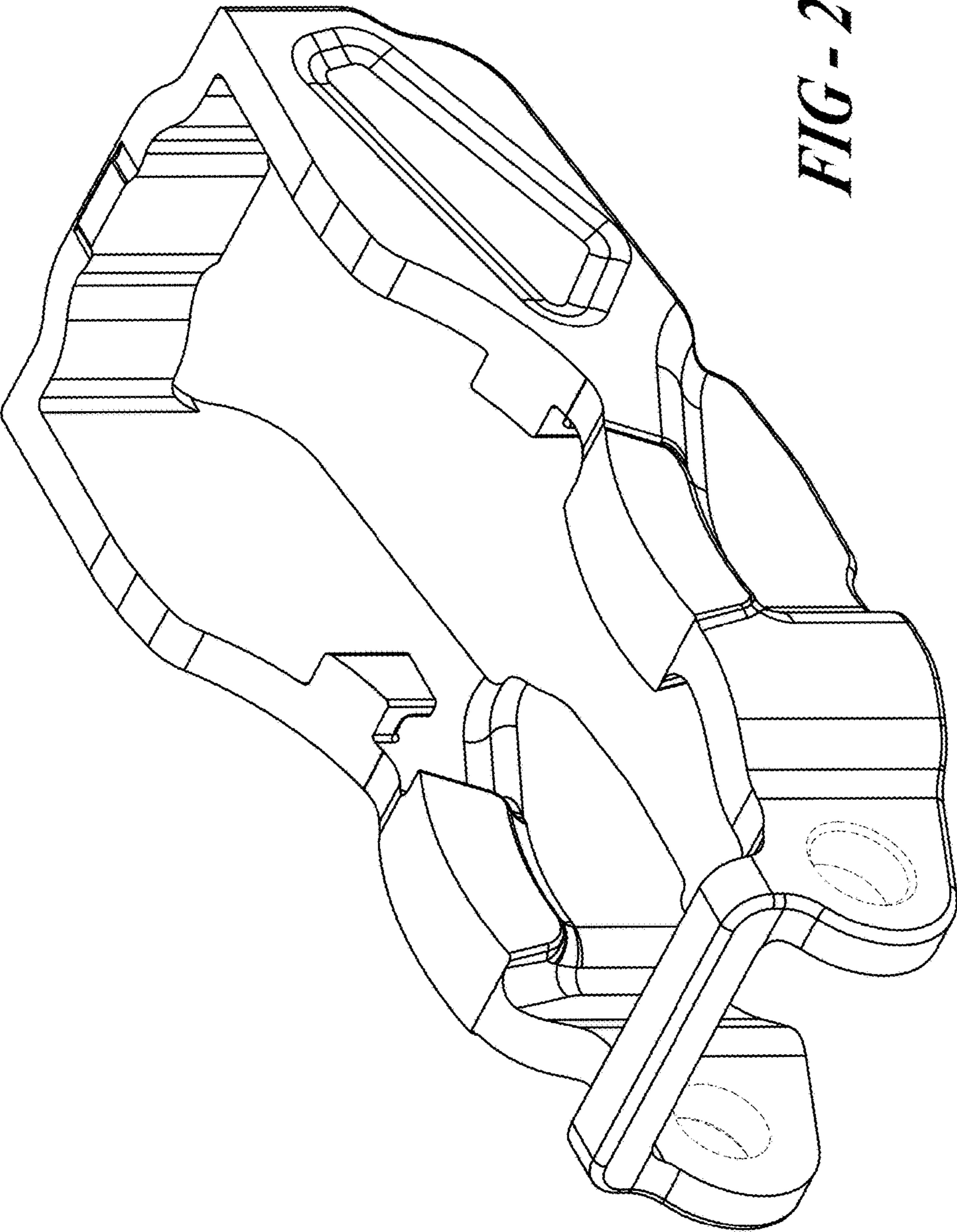
U.S. PATENT DOCUMENTS

|              |         |                  |                  |         |   |
|--------------|---------|------------------|------------------|---------|---|
| 7,278,384 B2 | 10/2007 | Fernandez et al. | 8,726,862 B2     | 5/2014  | Zurface et al.                          |
| 7,305,951 B2 | 12/2007 | Fernandez et al. | 8,726,863 B2     | 5/2014  | Meistrick et al.                        |
| 7,318,402 B2 | 1/2008  | Harman et al.    | 8,733,311 B2     | 5/2014  | Manther                                 |
| 7,328,675 B2 | 2/2008  | Seitz et al.     | 8,752,513 B2     | 6/2014  | Zurface et al.                          |
| 7,377,247 B2 | 5/2008  | Seitz            | 8,783,219 B2     | 7/2014  | Gunnel et al.                           |
| 7,444,967 B2 | 11/2008 | Kido et al.      | 8,807,101 B2     | 8/2014  | Choi et al.                             |
| 7,484,487 B2 | 2/2009  | Zurface et al.   | 8,915,225 B2     | 12/2014 | Zurface et al.                          |
| 7,503,300 B2 | 3/2009  | Seitz et al.     | 8,939,118 B2     | 1/2015  | Stoody                                  |
| 7,533,642 B2 | 5/2009  | Proschko et al.  | 8,955,481 B2     | 2/2015  | Manther                                 |
| 7,546,822 B2 | 6/2009  | Murphy et al.    | D750,670 S       | 3/2016  | McCarthy                                |
| 7,565,887 B2 | 7/2009  | Tsuruta et al.   | 2005/0188930 A1  | 9/2005  | Best                                    |
| 7,603,972 B2 | 10/2009 | Han et al.       | 2007/0089709 A1  | 4/2007  | Hartmann et al.                         |
| 7,661,400 B2 | 2/2010  | Seitz et al.     | 2007/0113809 A1  | 5/2007  | Harman et al.                           |
| 7,673,606 B2 | 3/2010  | Ng et al.        | 2007/0186890 A1  | 8/2007  | Zurface et al.                          |
| 7,677,213 B2 | 3/2010  | Deierlein        | 2007/0193543 A1  | 8/2007  | Best                                    |
| 7,712,443 B2 | 5/2010  | Gemein           | 2008/0245330 A1  | 10/2008 | Deierlein et al.                        |
| 7,721,694 B2 | 5/2010  | Fernandez et al. | 2008/0283003 A1  | 11/2008 | Hendriksma                              |
| 7,798,112 B2 | 9/2010  | Zurface et al.   | 2009/0078225 A1  | 3/2009  | Hendriksma                              |
| 7,798,113 B2 | 9/2010  | Fischer et al.   | 2009/0217895 A1  | 9/2009  | Spath et al.                            |
| 7,882,814 B2 | 2/2011  | Spath et al.     | 2011/0265750 A1  | 11/2011 | Becker et al.                           |
| 7,909,007 B2 | 3/2011  | Manther et al.   | 2013/0000582 A1  | 1/2013  | Church                                  |
| 7,934,477 B2 | 5/2011  | Elnick et al.    | 2013/0146008 A1  | 6/2013  | Stoody                                  |
| 8,006,657 B2 | 8/2011  | Riley et al.     | 2013/0220250 A1  | 8/2013  | Gunnel et al.                           |
| 8,056,523 B2 | 11/2011 | Ha et al.        | 2013/0233265 A1  | 9/2013  | Zurface et al.                          |
| 8,146,552 B2 | 4/2012  | Seitz et al.     | 2013/0284135 A1  | 10/2013 | Manther et al.                          |
| 8,151,763 B2 | 4/2012  | Meistrick et al. | 2013/0284136 A1  | 10/2013 | Manther et al.                          |
| 8,215,275 B2 | 7/2012  | Church           | 2013/0284137 A1  | 10/2013 | Manther et al.                          |
| 8,251,032 B2 | 8/2012  | Manther          | 2013/0306013 A1  | 11/2013 | Zurface et al.                          |
| 8,267,059 B2 | 9/2012  | Manther et al.   | 2013/0312506 A1  | 11/2013 | Nielsen et al.                          |
| 8,297,243 B2 | 10/2012 | Kang             | 2013/0312689 A1* | 11/2013 | Zurface ..... F01L 13/0036<br>123/90.45 |
| 8,312,851 B2 | 11/2012 | Heinemann        | 2014/0041608 A1  | 2/2014  | Zurface                                 |
| 8,393,308 B2 | 3/2013  | Kang et al.      | 2014/0116366 A1  | 5/2014  | Harman                                  |
| 8,434,440 B2 | 5/2013  | Manther et al.   | 2014/0150745 A1  | 6/2014  | Church                                  |
| 8,474,425 B2 | 7/2013  | Kirbach          | 2014/0190431 A1  | 7/2014  | McCarthy                                |
| 8,479,694 B2 | 7/2013  | Manther et al.   | 2014/0209048 A1  | 7/2014  | Manther et al.                          |
| 8,505,509 B2 | 8/2013  | Ha et al.        | 2014/0290608 A1  | 10/2014 | Radulescu                               |
| 8,528,508 B2 | 9/2013  | Meistrick et al. | 2015/0308300 A1* | 10/2015 | Braun ..... F01L 1/18<br>74/559         |
| 8,555,835 B2 | 10/2013 | Pätzold et al.   | 2016/0138435 A1  | 5/2016  | Zurface et al.                          |
| 8,607,753 B2 | 12/2013 | Krause et al.    | 2016/0138484 A1* | 5/2016  | Nielsen ..... F01L 3/08<br>73/114.79    |
| 8,627,796 B2 | 1/2014  | Harman           | 2016/0265394 A1  | 9/2016  | Brune et al.                            |
| 8,635,980 B2 | 1/2014  | Church           | 2017/0328244 A1* | 11/2017 | VanDeusen ..... F01L 1/185              |
| 8,677,958 B2 | 3/2014  | Becker et al.    |                  |         |   |

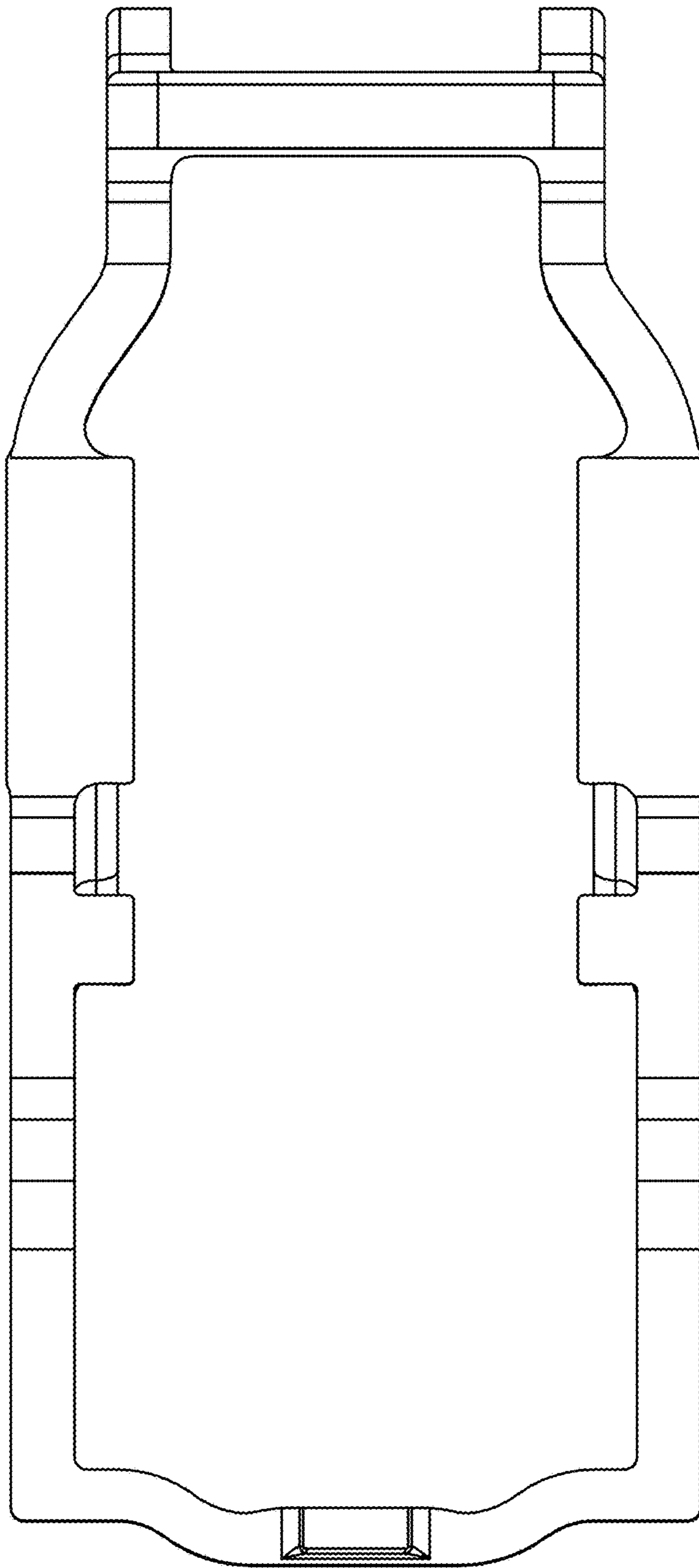
\* cited by examiner



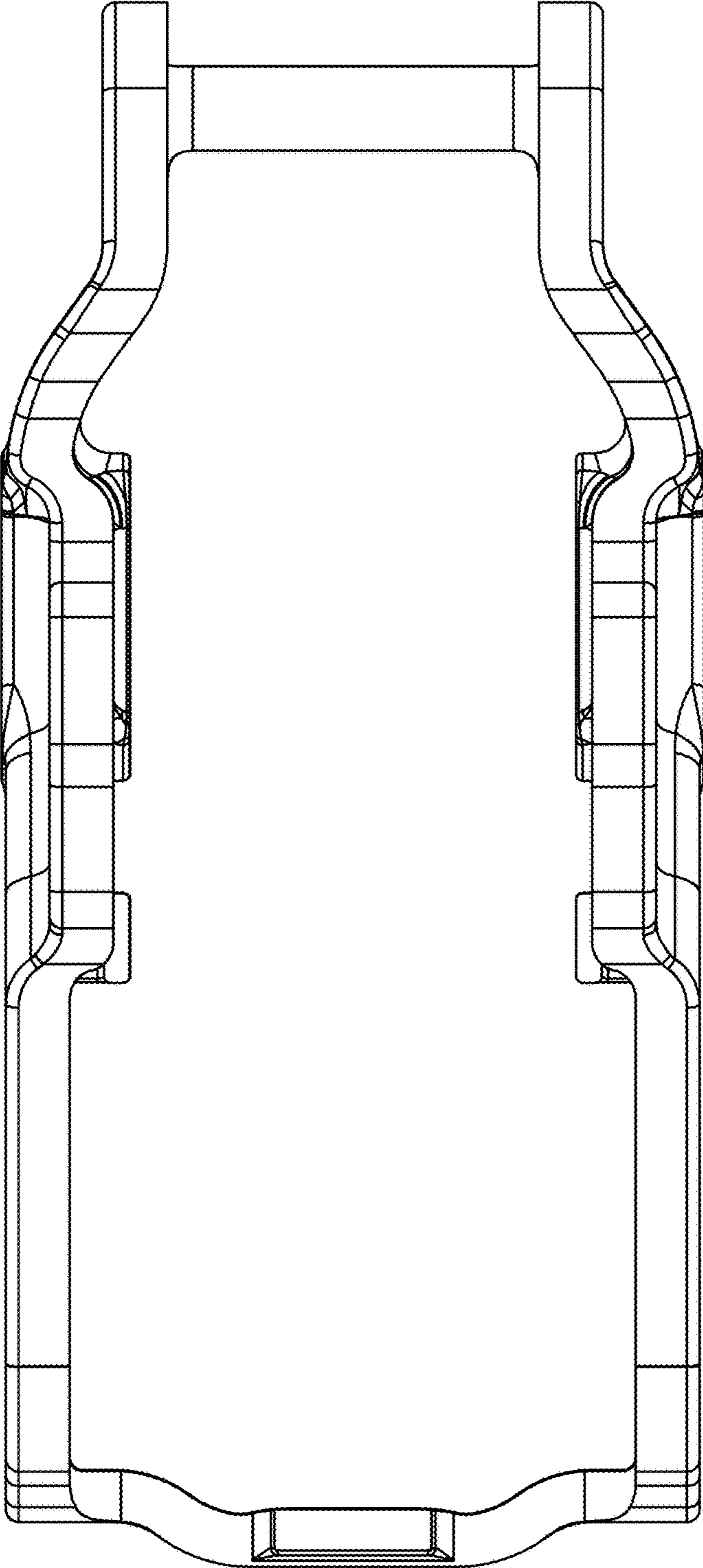
**FIG - 1**



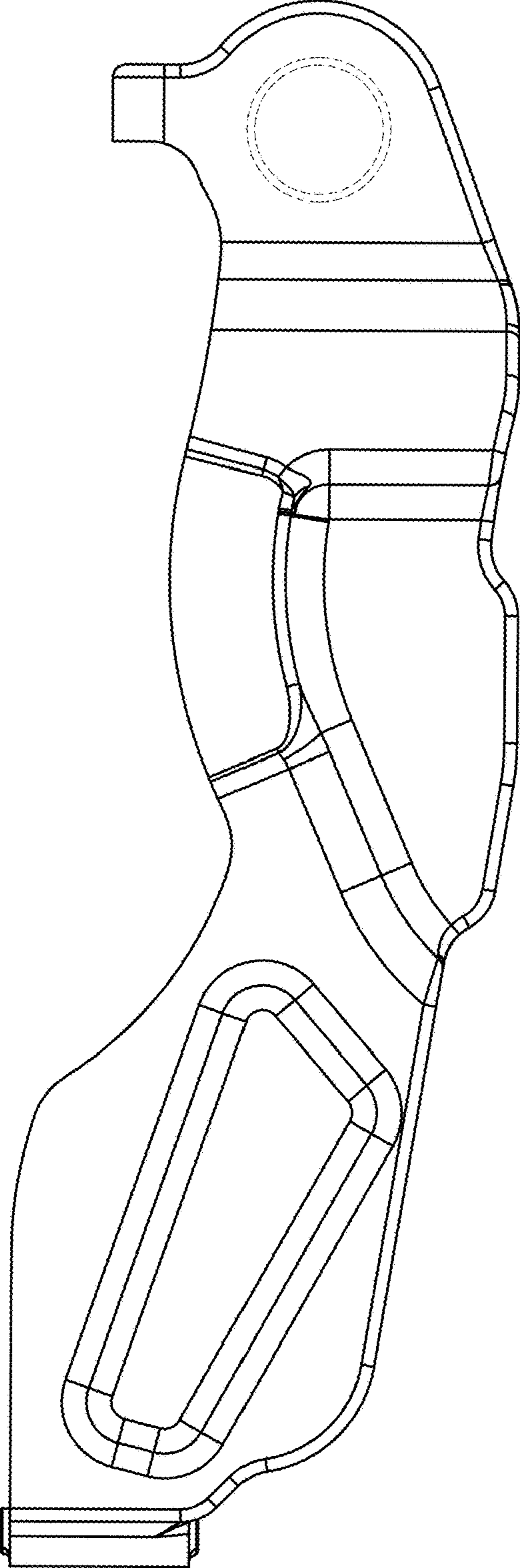
**FIG - 2**



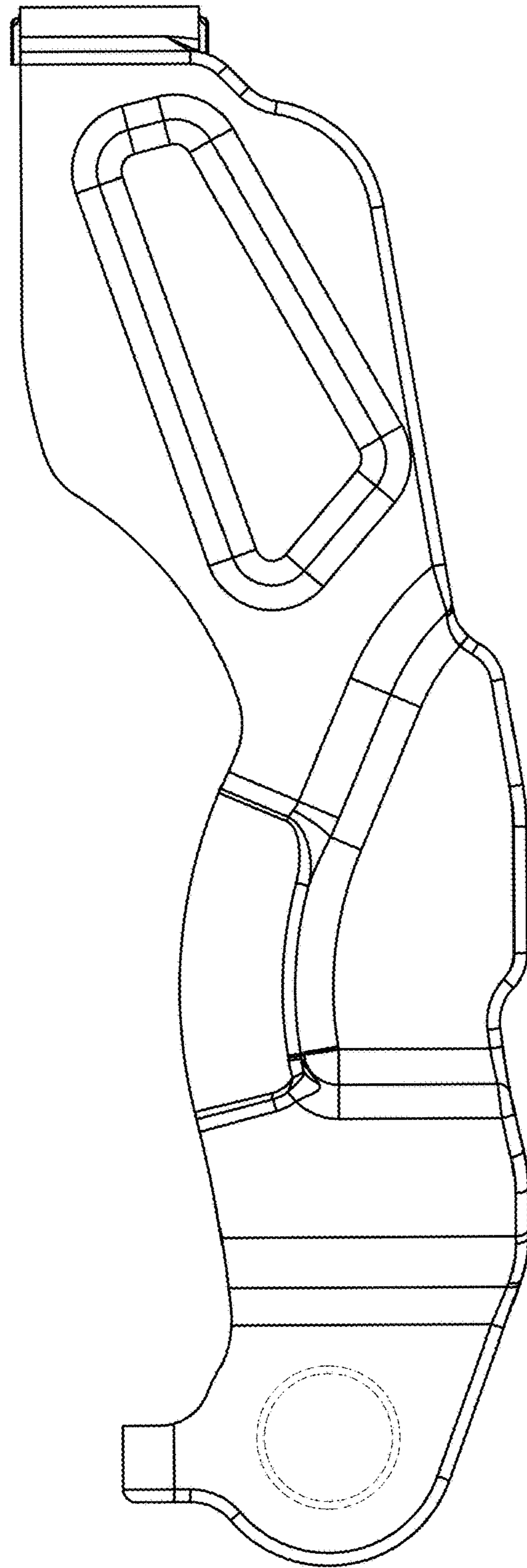
*FIG - 3*



*FIG - 4*

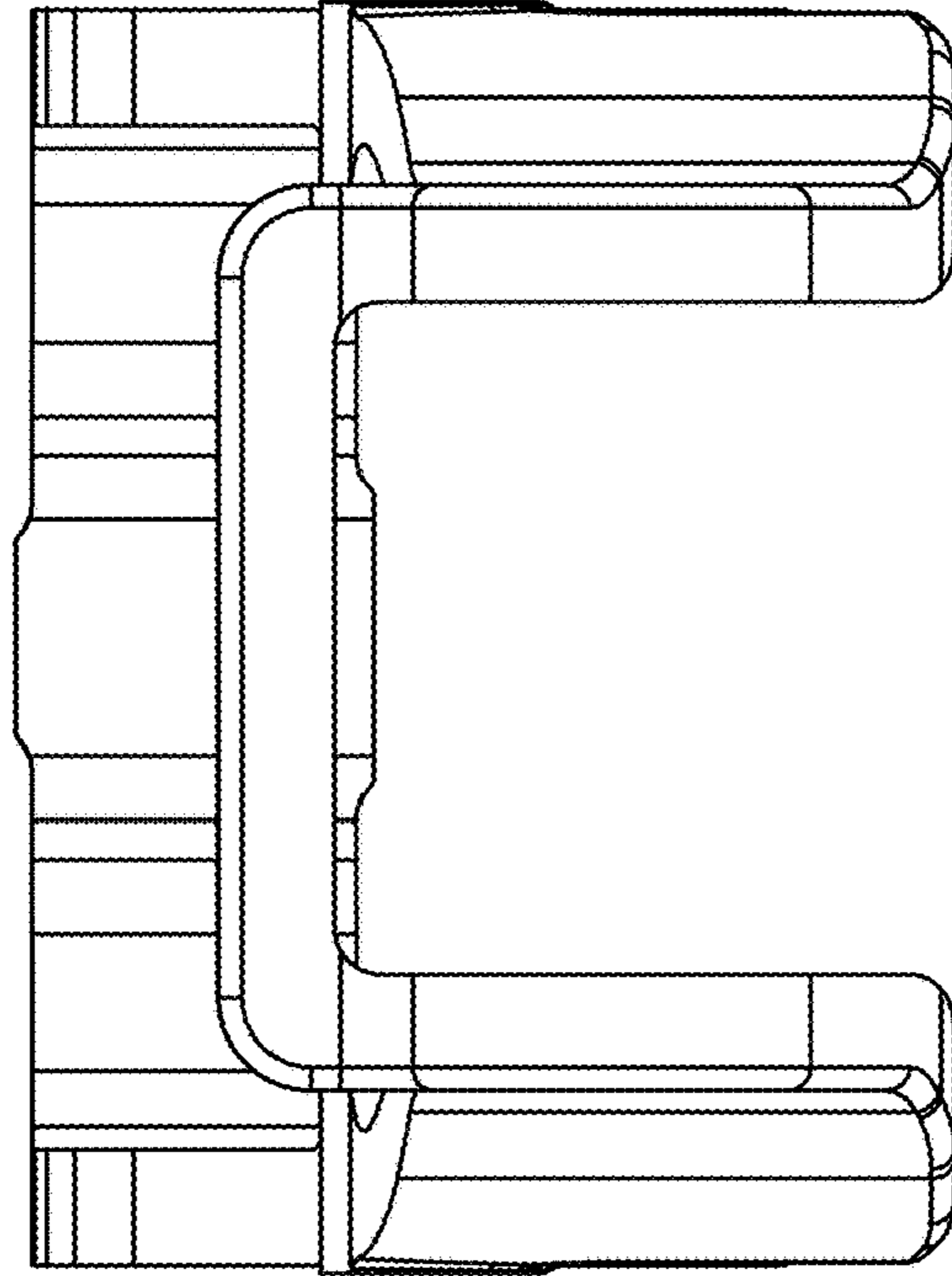


*FIG - 5*

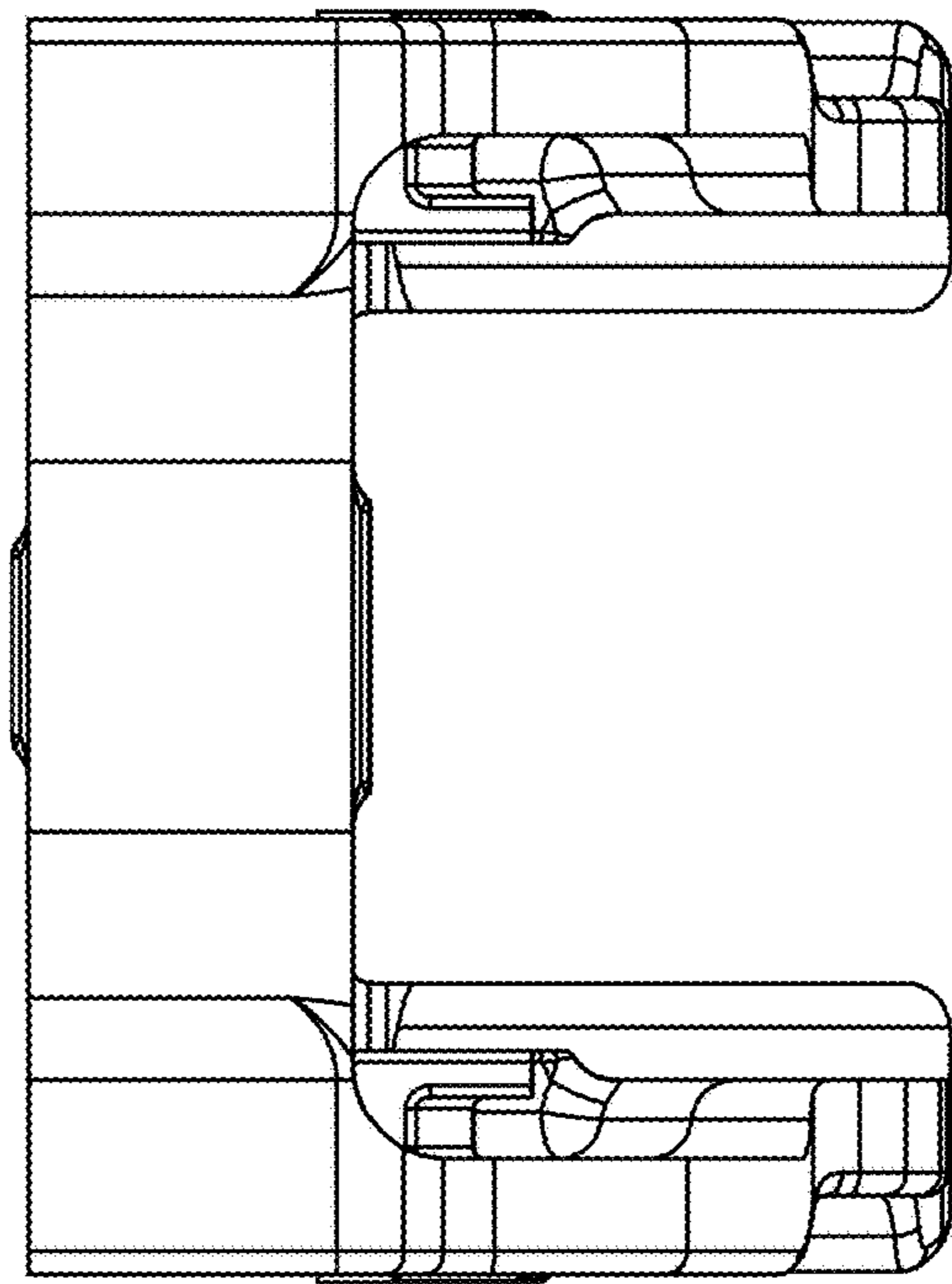


*FIG - 6*





*FIG - 8*



*FIG - 7*