



US00D833430S

(12) **United States Design Patent**
Lin et al.

(10) **Patent No.:** **US D833,430 S**

(45) **Date of Patent:** **** Nov. 13, 2018**

- (54) **WEARABLE ELECTRONIC DEVICE**
- (71) Applicants: **Yong-Jun Lin**, Alhambra, CA (US);
Wei-Cheng Chou, Alhambra, CA (US)
- (72) Inventors: **Yong-Jun Lin**, Alhambra, CA (US);
Wei-Cheng Chou, Alhambra, CA (US)
- (73) Assignee: **Innovart Design Inc.**, Alhambra, CA (US)

- D386,105 S * 11/1997 Kornmann D11/4
- D515,450 S * 2/2006 Schiesl-Griesinger D11/4
- D527,280 S * 8/2006 Bulgari D10/32
- D560,134 S * 1/2008 Chen D11/4
- D566,580 S * 4/2008 Giorgio D10/32
- D586,667 S * 2/2009 Brady D10/32
- D640,572 S * 6/2011 Calce D10/32
- D709,047 S * 7/2014 Jennings D14/167
- D711,268 S * 8/2014 Kim D10/70
- D716,458 S * 10/2014 Snyder D24/186
- D725,535 S * 3/2015 Harel-Klein D11/35
- D726,572 S * 4/2015 Walters D11/3
- D730,763 S * 6/2015 Haapakoski D10/70

(**) Term: **15 Years**

(Continued)

(21) Appl. No.: **29/591,788**

(22) Filed: **Jan. 24, 2017**

(51) **LOC (11) Cl.** **14-02**

(52) **U.S. Cl.**
USPC **D14/344**

(58) **Field of Classification Search**
USPC ... D14/344, 138 R, 144, 341, 358, 485-489,
D14/218; D10/30-39, 70, 98; D11/3,
D11/93-94; D24/167, 169, 186-187;
361/679.03; 379/433.1; D13/108
CPC .. A41D 1/002; G06F 1/04; G06F 1/08; G06F
1/10; G06F 1/14; G06F 1/1626; G06F
1/1628; G06F 1/163; G06F 1/1635; G06F
1/3203; G06Q 20/10; G06Q 20/12; G06Q
20/108; G06Q 20/145; H04B 1/3833;
H04B 1/385; H04B 1/3888; H04M 1/02;
H04M 1/03; H04M 1/04; H04M 1/05;
H04M 1/667; H04M 1/6058; Y02B
60/1217

See application file for complete search history.

(56) **References Cited**

U.S. PATENT DOCUMENTS

- D52,465 S * 9/1918 Block 224/165
- D82,091 S * 9/1930 Hill D11/26
- D291,423 S * 8/1987 Lajoie D11/26
- D310,490 S * 9/1990 Fong D10/31

OTHER PUBLICATIONS

Glitter Collection Digital Black Dial Women/Girls LED Watch (MGBLK0001), posted Sep. 4, 2015, [retrieved Jan. 3, 2018]. Retrieved from Internet, <URL: <https://www.amazon.in/Glitter-Collection-Digital-Black-MGBLK0001/dp/B014X2ZEOM>>.*

(Continued)

Primary Examiner — Barbara Fox

Assistant Examiner — Kristin E Reed

(74) *Attorney, Agent, or Firm* — Che-Yang Chen; Law Offices of Scott Warmuth

(57) **CLAIM**

The ornamental design for a wearable electronic device, as shown and described.

DESCRIPTION

FIG. 1 is a perspective view of a wearable electronic device showing my new design;
FIG. 2 is a front elevational view thereof;
FIG. 3 is a rear elevational view thereof;
FIG. 4 is a left side elevational view thereof;
FIG. 5 is a right side elevational view thereof;
FIG. 6 is a top plan view thereof; and,
FIG. 7 is a bottom plan view thereof.

1 Claim, 5 Drawing Sheets

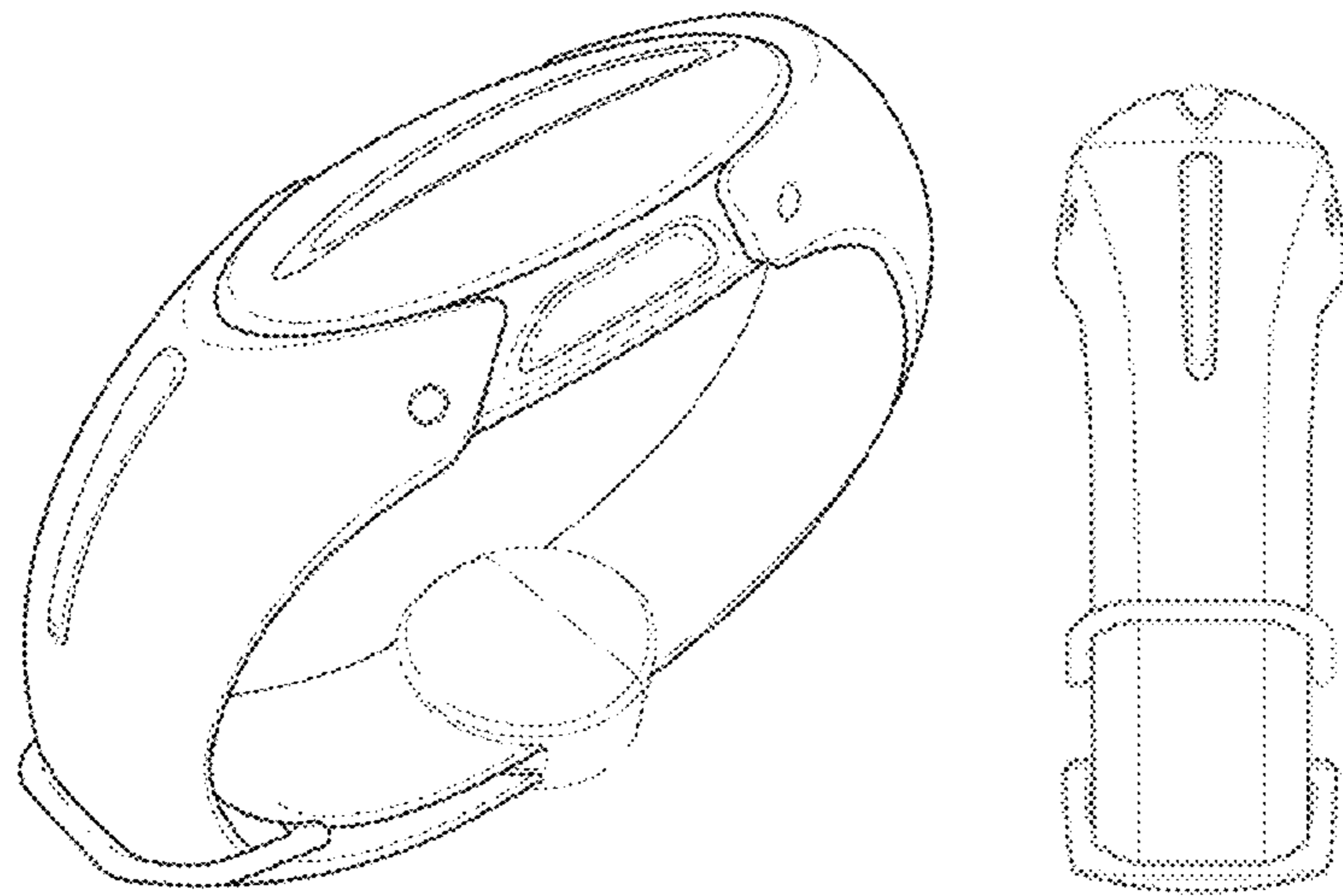

(56)

References Cited

U.S. PATENT DOCUMENTS

D735,587 S * 8/2015 Squires D10/32
D737,699 S * 9/2015 Chang D10/39
D755,787 S * 5/2016 Zander D14/344
D779,996 S * 2/2017 Setran D11/4
D789,219 S * 6/2017 Ferraris D10/32
2005/0237704 A1* 10/2005 Ceresoli G06F 1/163
361/679.03
2011/0319024 A1* 12/2011 Fish H04B 5/0006
455/41.3
2015/0101788 A1* 4/2015 Smith G01K 1/143
165/201

OTHER PUBLICATIONS

LG Smart Activity Tracker: This FuelBand Clone Is a Mashup of Every Wearable Gadget, posted Jan. 9, 2013, [retrieved Jan. 3, 2018]. Retrieved from Internet, <URL: <https://gizmodo.com/5974676/lg-smart-activity-tracker-this-fuelband-clone-is-a-mashup-of-every-wearable-gadget> >.*

Withings Pulse O2 Activity, Sleep, and Heart Rate, posted Apr. 29, 2014, [retrieved Jan. 3, 2018]. Retrieved from Internet, <URL: https://www.amazon.com/gp/product/B00J8LVJQG/ref=as_li_qf_sp_asin_il_tl?ie=UTF8&camp=1789&creative=9325&creativeASIN=B00J8LVJQG&linkCode=as2&tag=xaybzc-20&linkId=WVOB73QLTYGZUVDD >.*

* cited by examiner

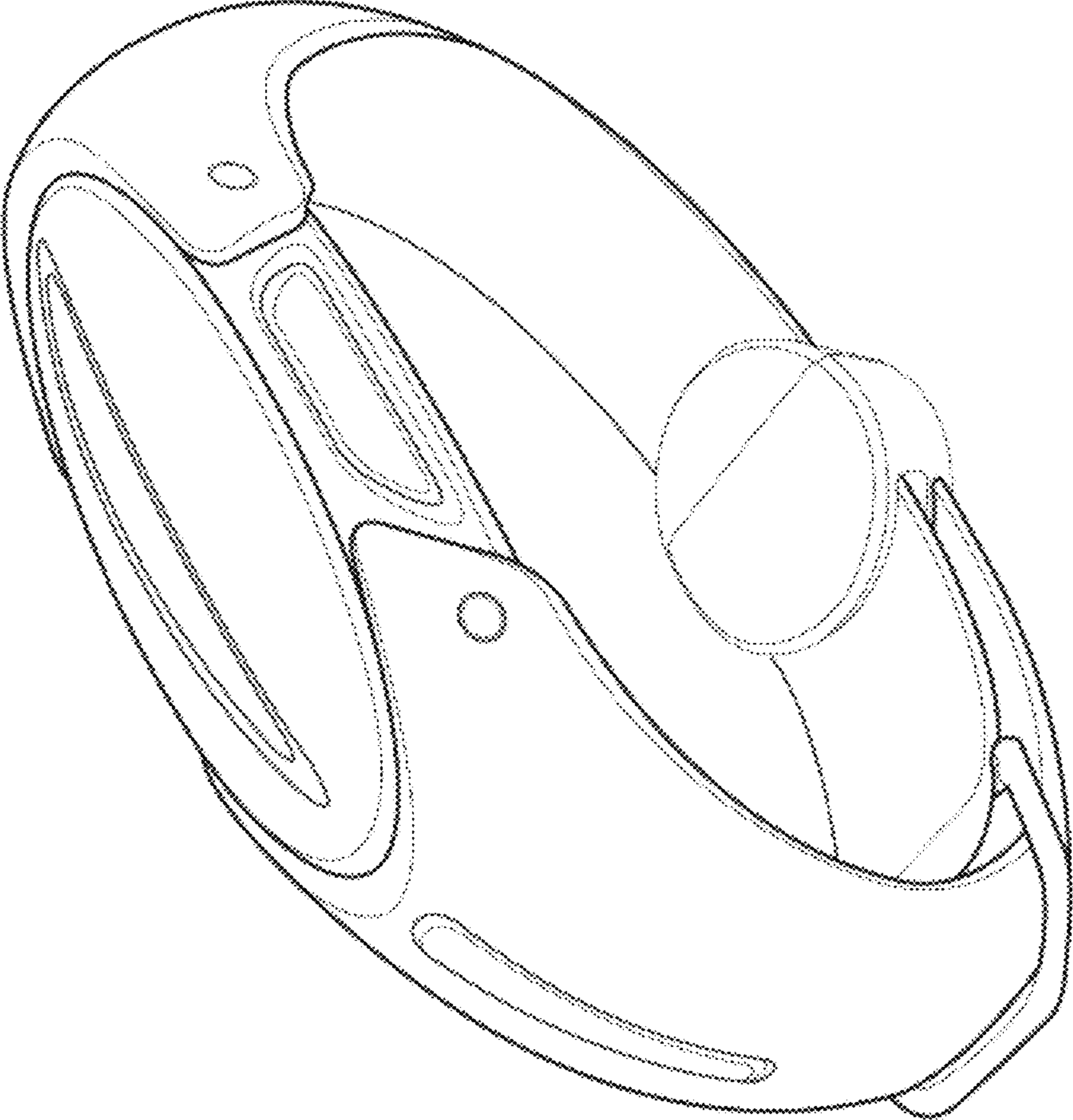

FIG. 1

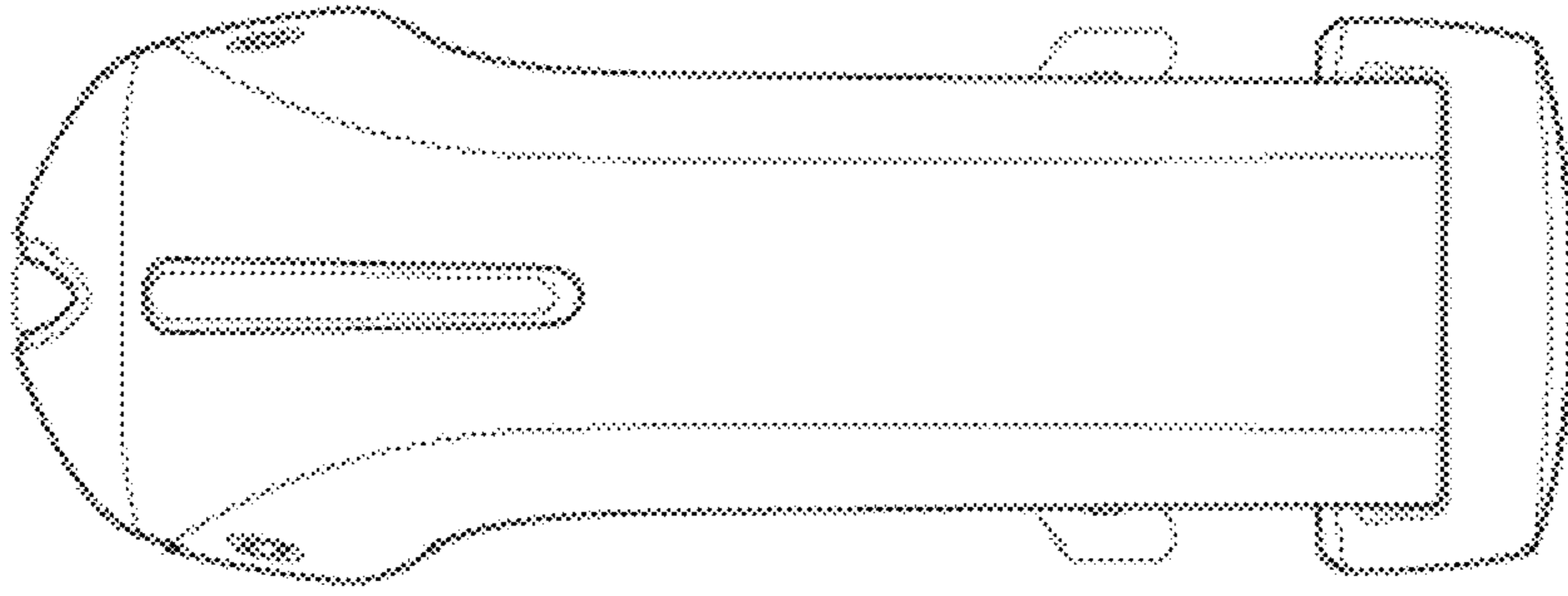

FIG. 2

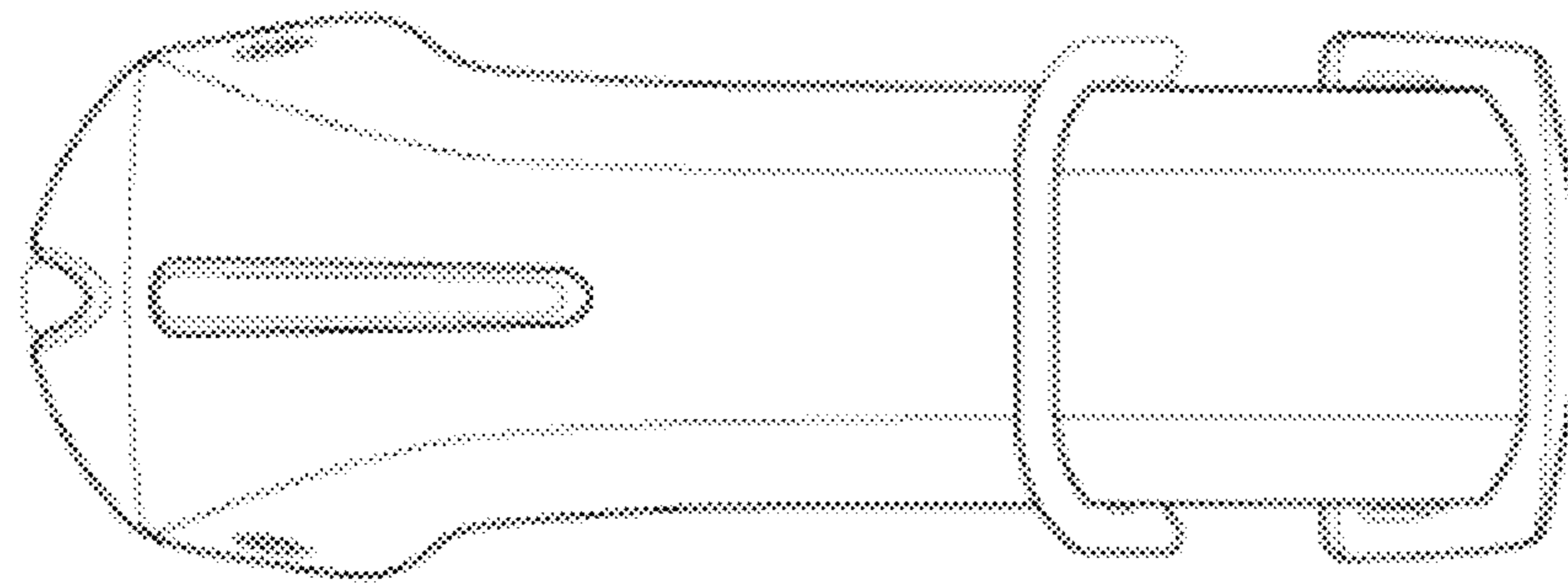

FIG. 3

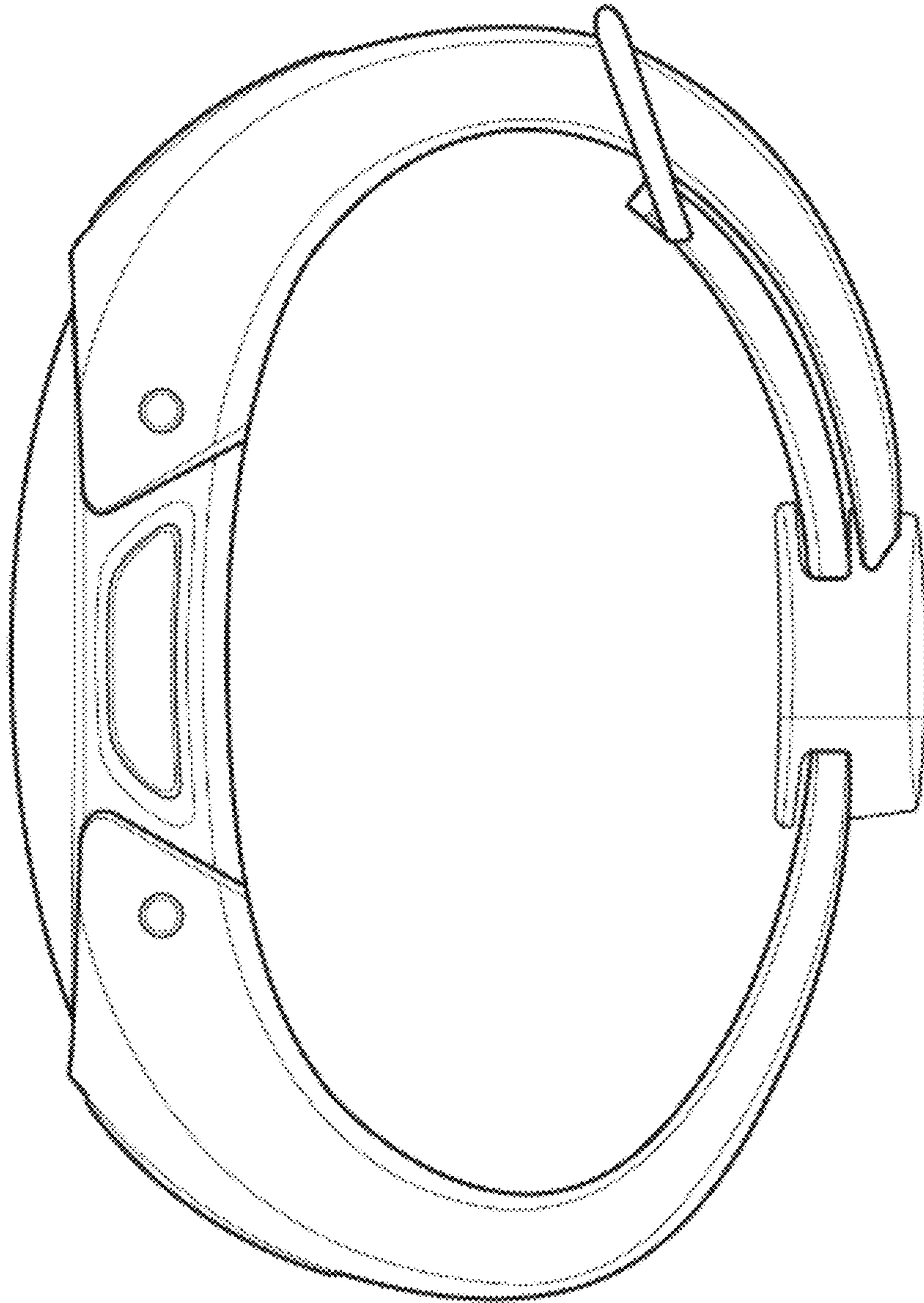

FIG. 4

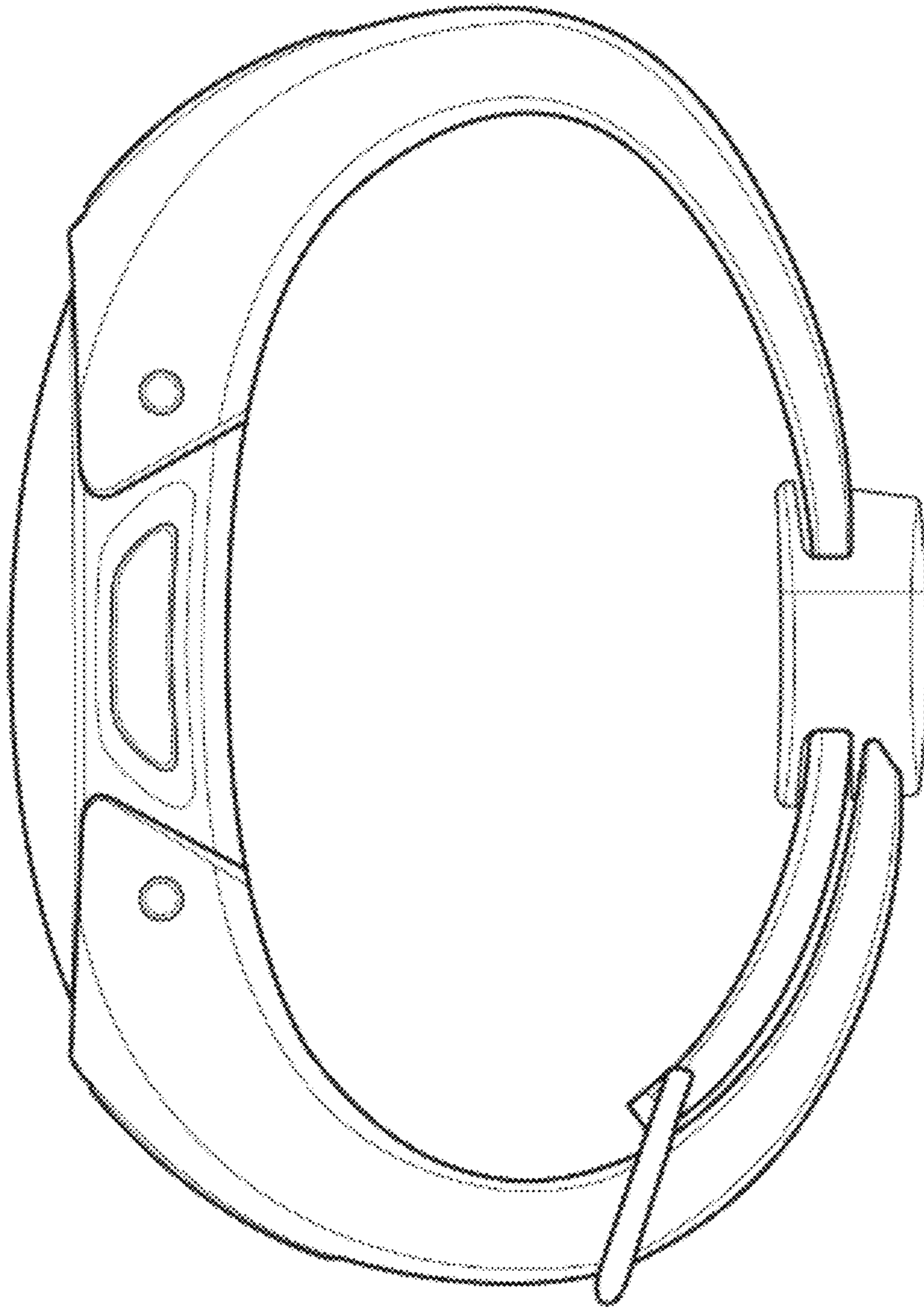

FIG. 5

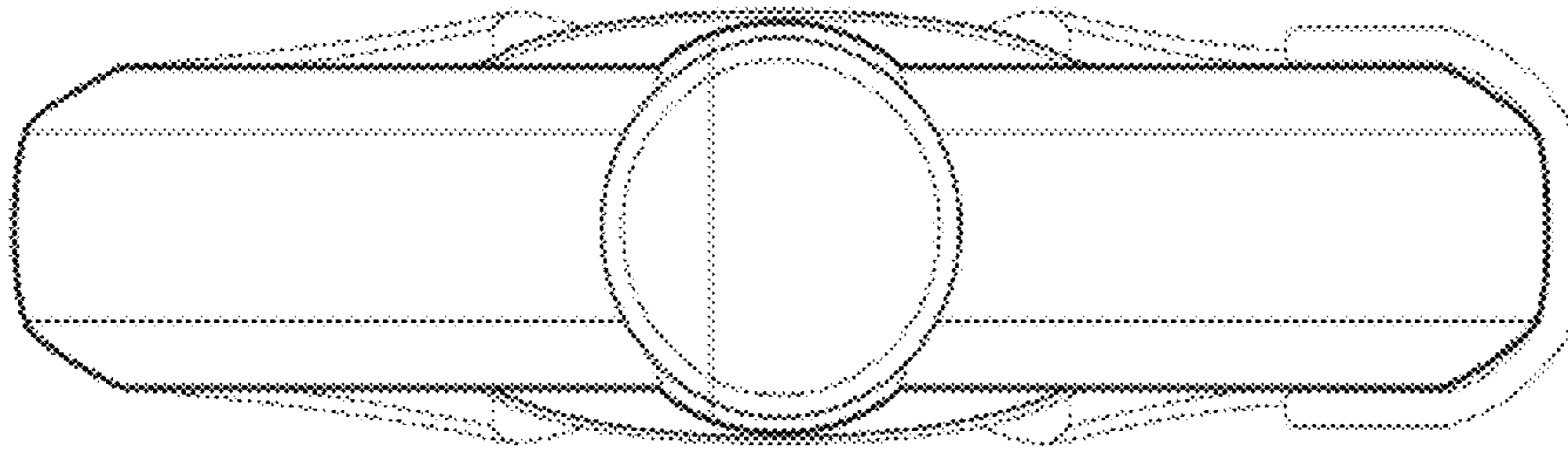

FIG. 7

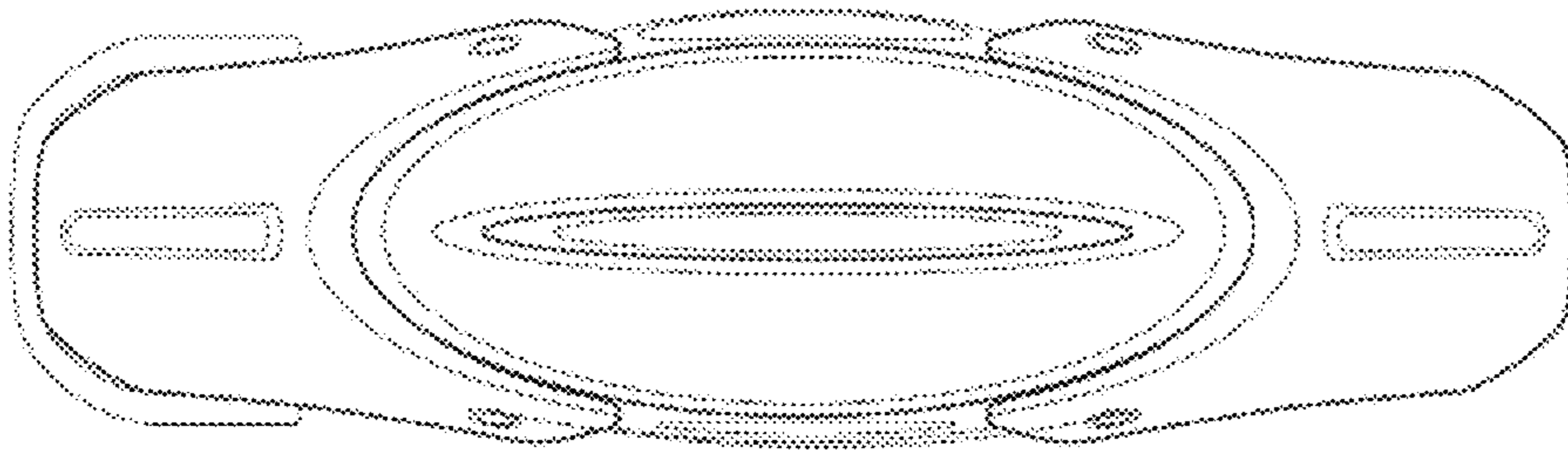

FIG. 6