



US00D833426S

(12) **United States Design Patent**  
**Yun**

(10) **Patent No.:** **US D833,426 S**

(45) **Date of Patent:** **\*\* Nov. 13, 2018**

(54) **CASE FOR ELECTRONIC COMMUNICATIONS DEVICE**

(71) Applicant: **SPIGEN KOREA CO., LTD.**, Seoul (KR)

(72) Inventor: **Sun Woo Yun**, Seoul (KR)

(73) Assignee: **SPIGEN KOREA CO., LTD.**, Bongeunsa-ro, Gangnam-gu, Seoul (KR)

(\*\*) Term: **15 Years**

(21) Appl. No.: **29/624,854**

(22) Filed: **Nov. 3, 2017**

(51) **LOC (11) Cl.** ..... **14-03**

(52) **U.S. Cl.**  
USPC ..... **D14/250**

(58) **Field of Classification Search**  
USPC ..... D14/248, 439, 203.3-203.7, 447, 238.1, D14/440, 251-253, 217, 240, 250;  
(Continued)

(56) **References Cited**

**U.S. PATENT DOCUMENTS**

D575,056 S \* 8/2008 Tan ..... D3/201  
D616,361 S \* 5/2010 Huang ..... D13/103  
(Continued)

*Primary Examiner* — Carla J Wright

(74) *Attorney, Agent, or Firm* — Heedong Chae; Lucem, PC

(57) **CLAIM**

The ornamental design for a case for electronic communications device, as shown and described.

**DESCRIPTION**

FIG. 1 is a front perspective view of a case for electronic communications device showing my new design;

FIG. 2 is a rear perspective view thereof;  
FIG. 3 is a front elevational view thereof;  
FIG. 4 is a rear elevational view thereof;  
FIG. 5 is a left side elevational view thereof;  
FIG. 6 is a right side elevational view thereof;  
FIG. 7 is top plan view thereof;  
FIG. 8 is a bottom plan view thereof;  
FIG. 9 is a front perspective view of the upper component of the case shown separately for clarity of disclosure;  
FIG. 10 is a front perspective view of the middle component of the case shown separately for clarity of disclosure;  
FIG. 11 is a front perspective view of the bottom component of the case shown separately for clarity of disclosure;  
FIG. 12 is a rear perspective view of the upper component of the case shown separately for clarity of disclosure;  
FIG. 13 is rear perspective view of the middle component of the case shown separately for clarity of disclosure;  
FIG. 14 is a rear perspective view of the bottom component of the case shown separately for clarity of disclosure;  
FIG. 15 is an exploded front perspective view showing the components of the case separated for clarity of disclosure; and,  
FIG. 16 is an exploded rear perspective view showing the components of the case separated for clarity of disclosure. Although the case for electronic communications device, in which the claimed design is embodied, consists of an upper component, a middle component, and a bottom component, the claim is directed to the ornamental appearance of the case for electronic communications device in its entirety and does not extend to the ornamental appearance of each of the individual components of the case for electronic communications device.

The broken lines throughout the drawing figures depict portions of case for electronic communications device that form no part of the claimed design. The broken lines and regions bounded by broken lines form no part of the claimed design.

**1 Claim, 16 Drawing Sheets**

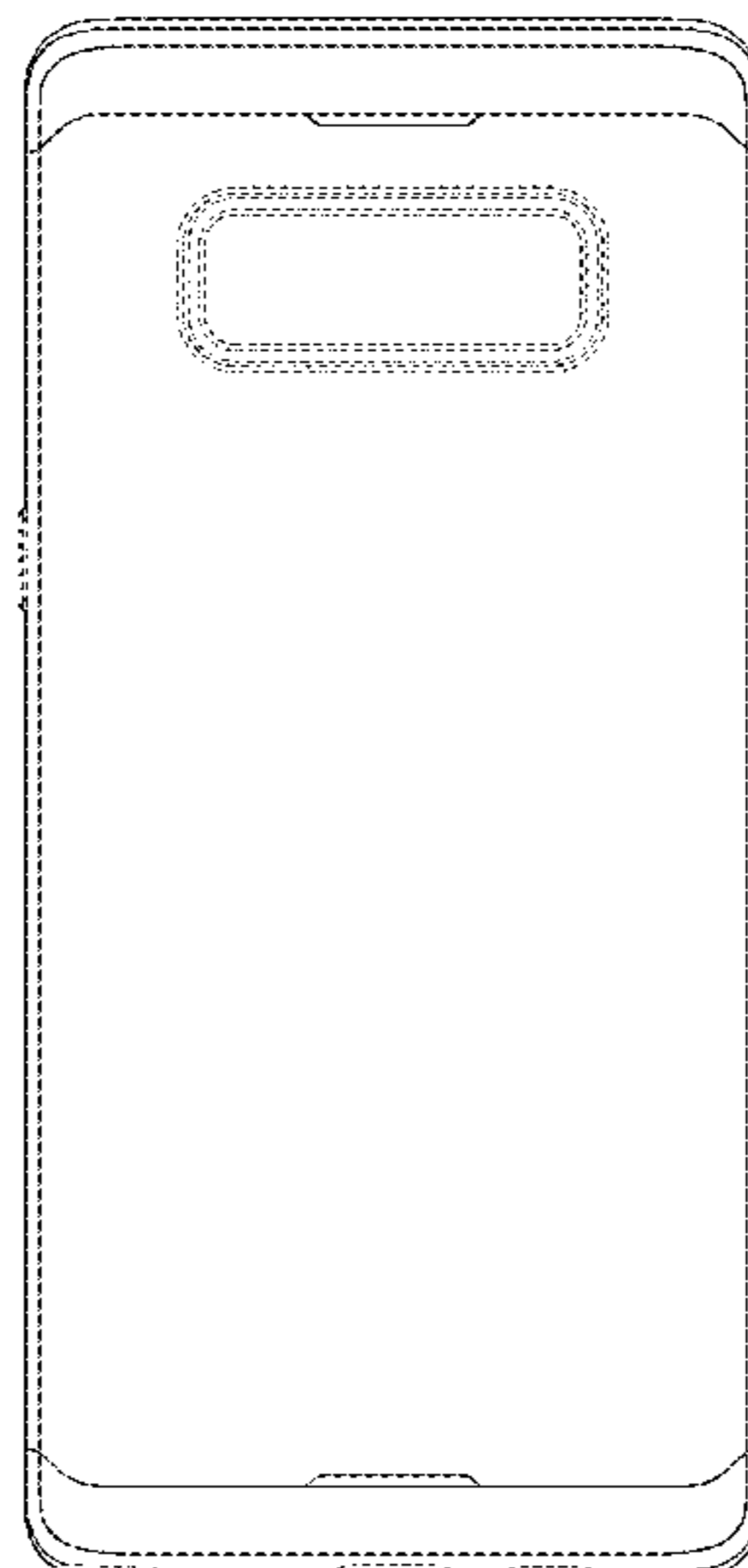
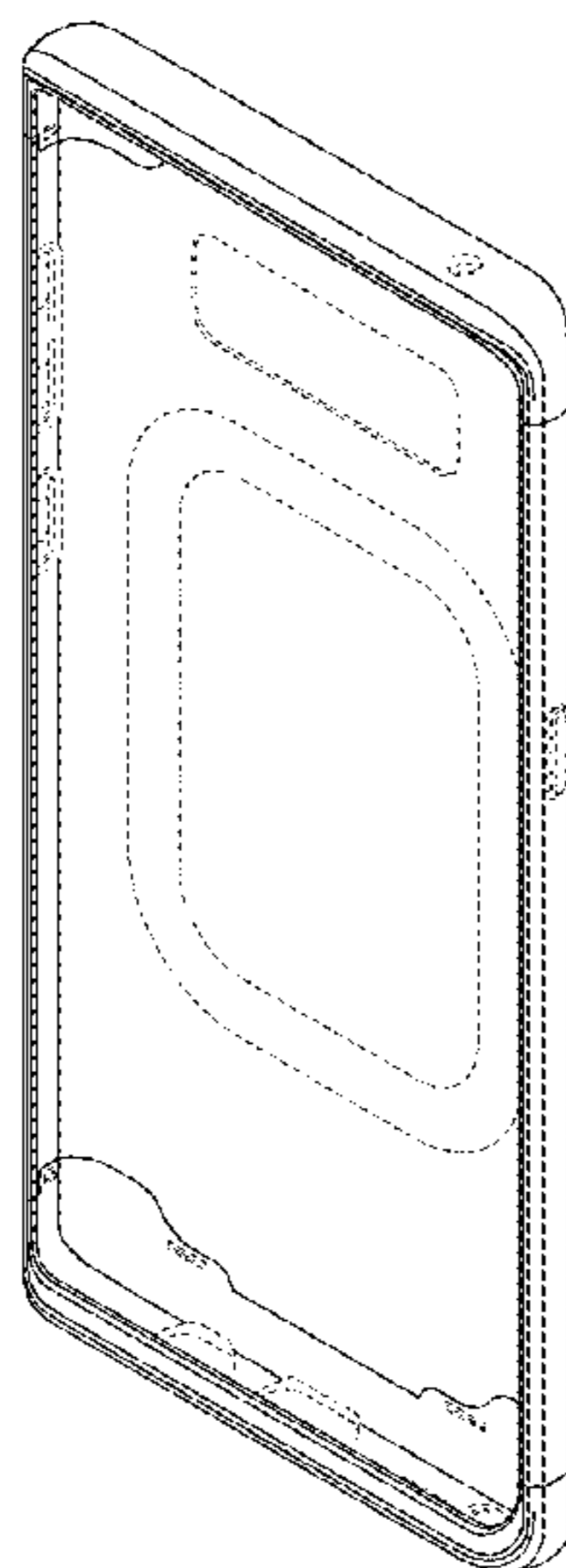



FIG. 1

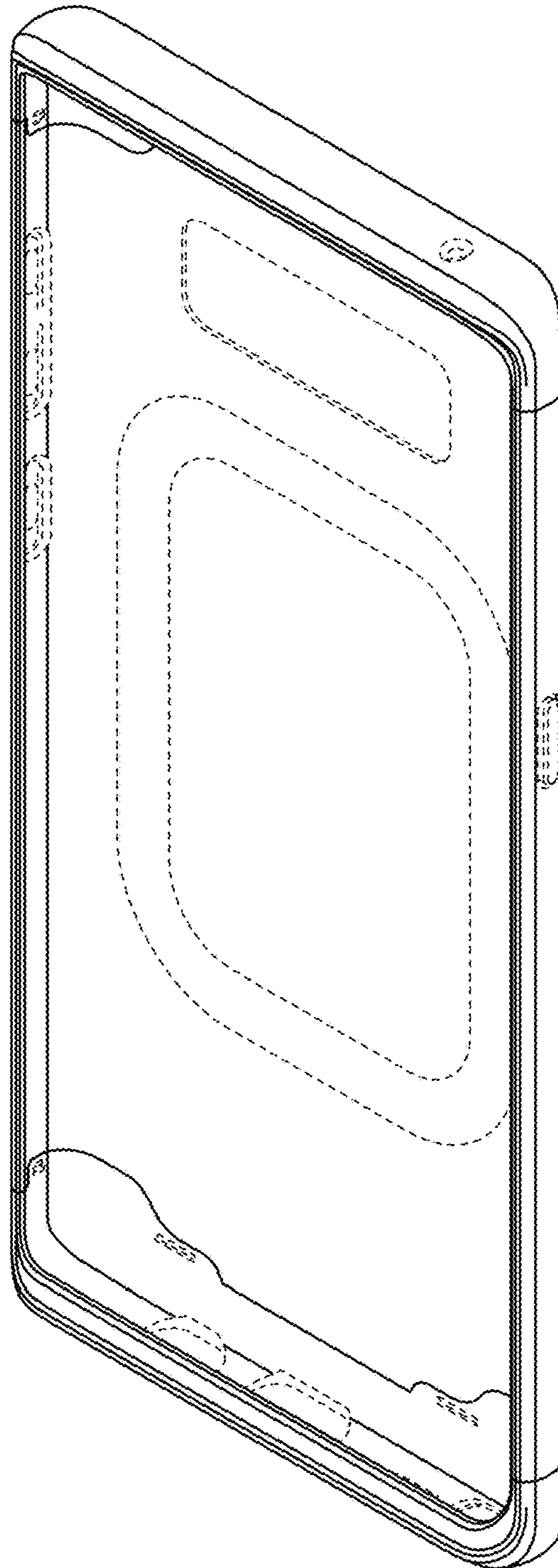

FIG. 2

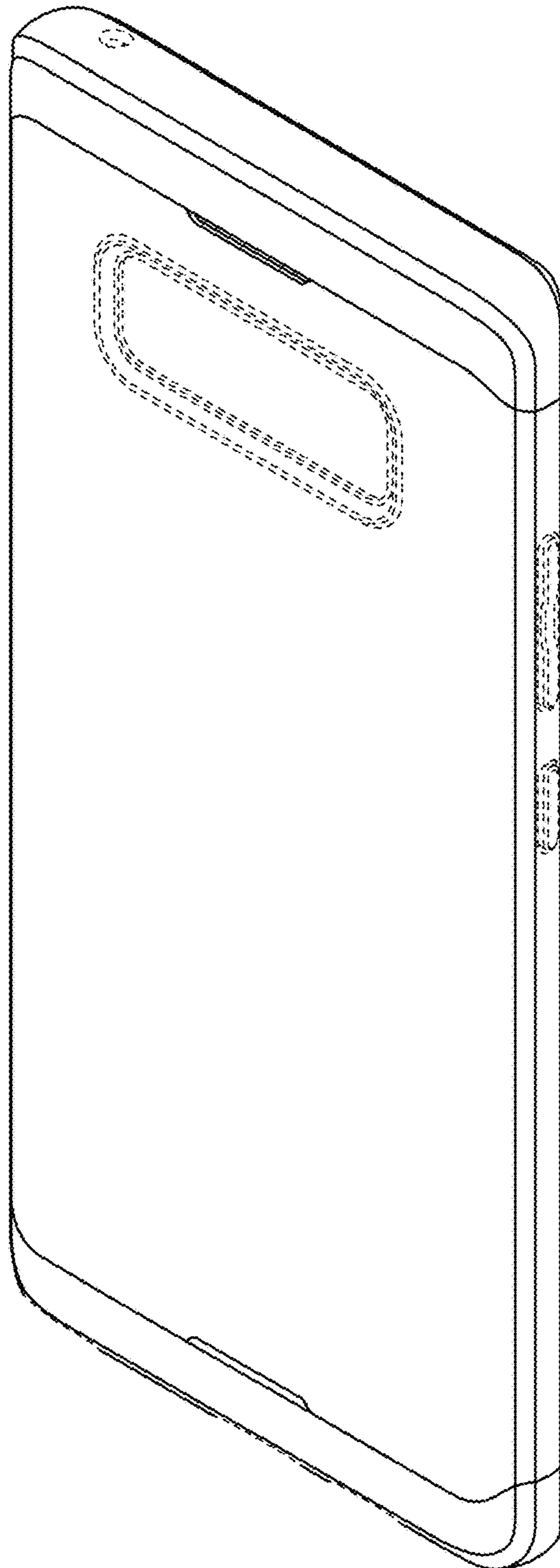

FIG. 3

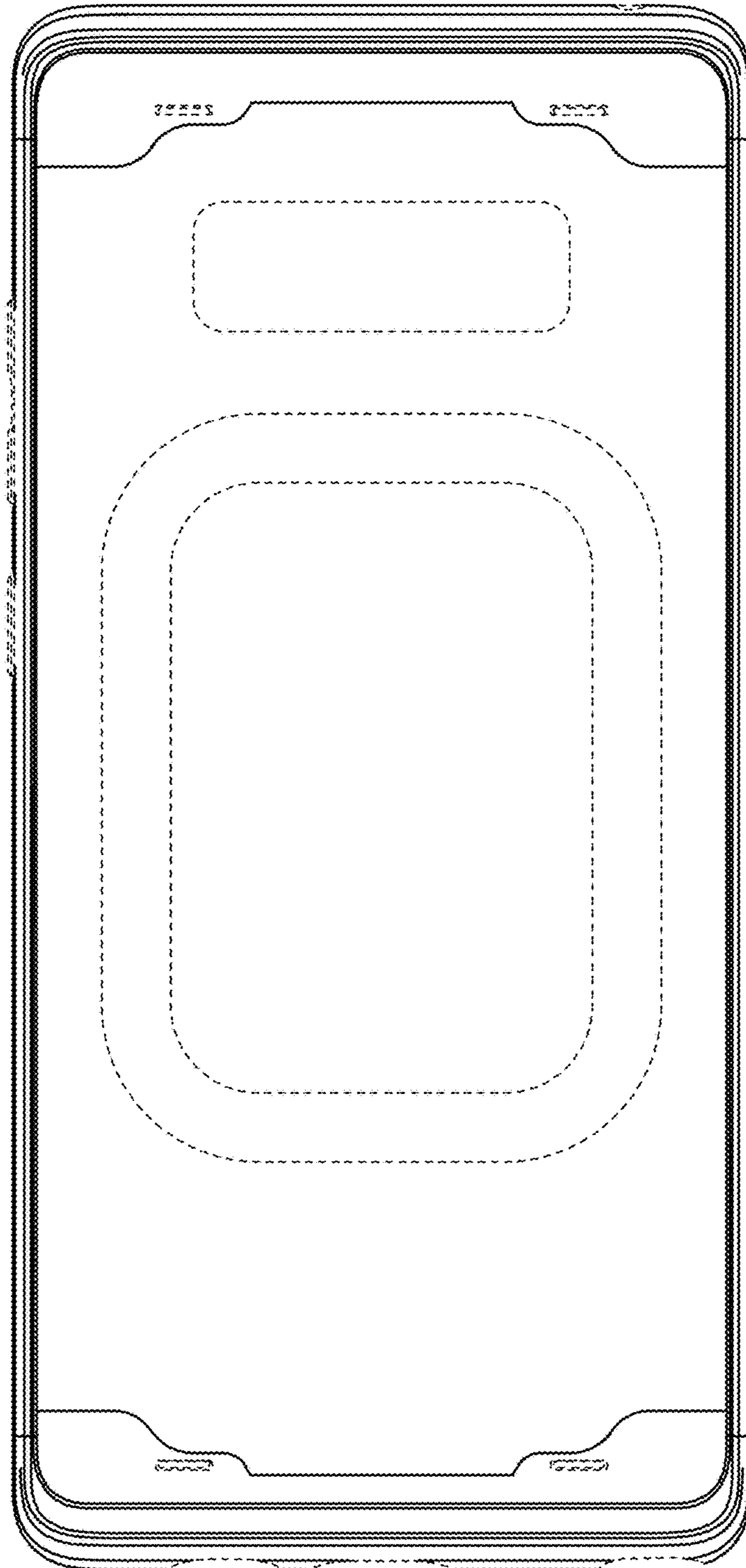

FIG. 4

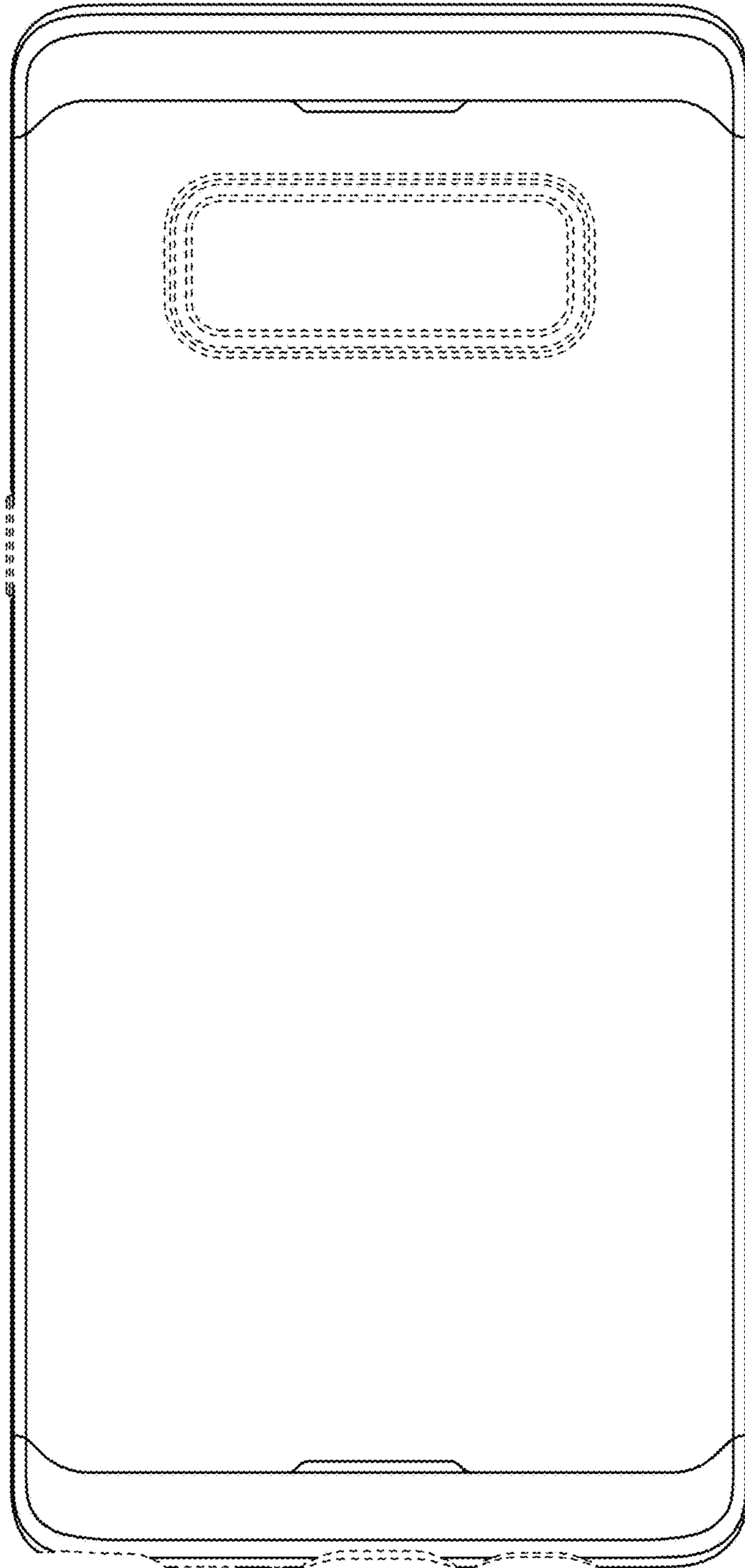

FIG. 5

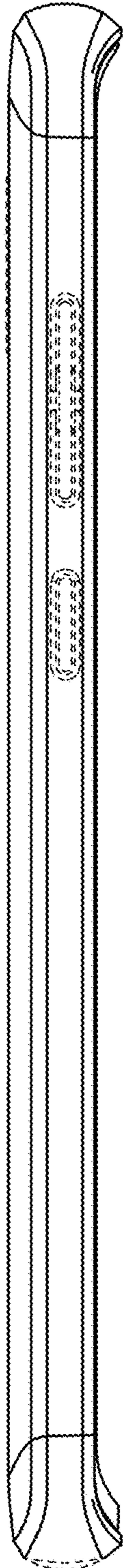

FIG. 6

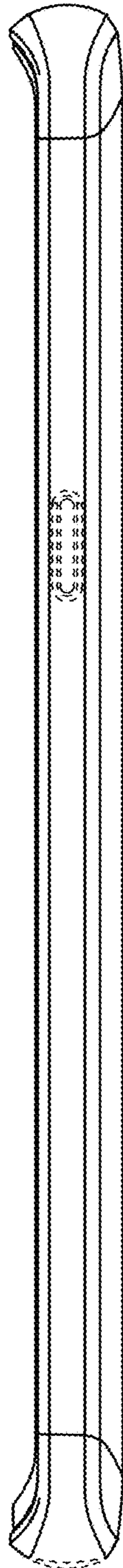



FIG. 7

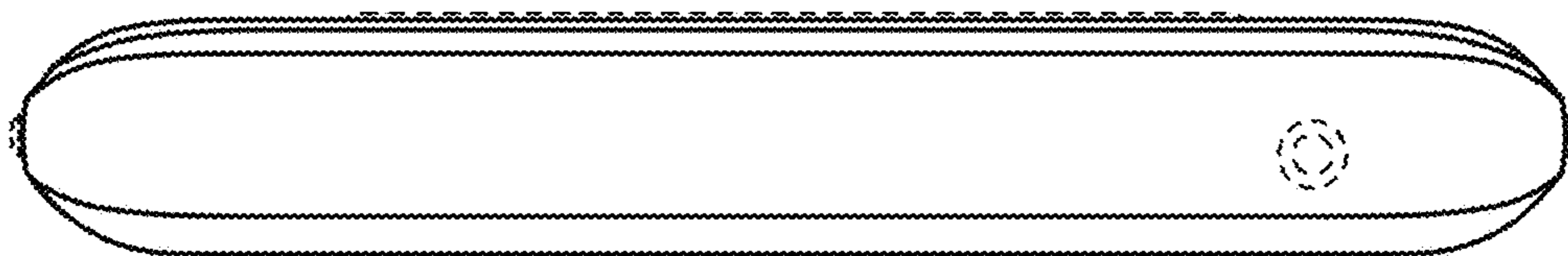

FIG. 8

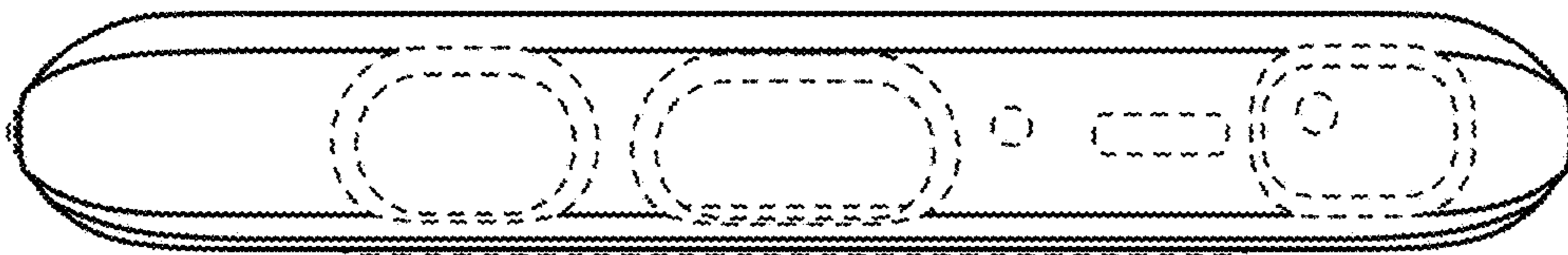

FIG. 9

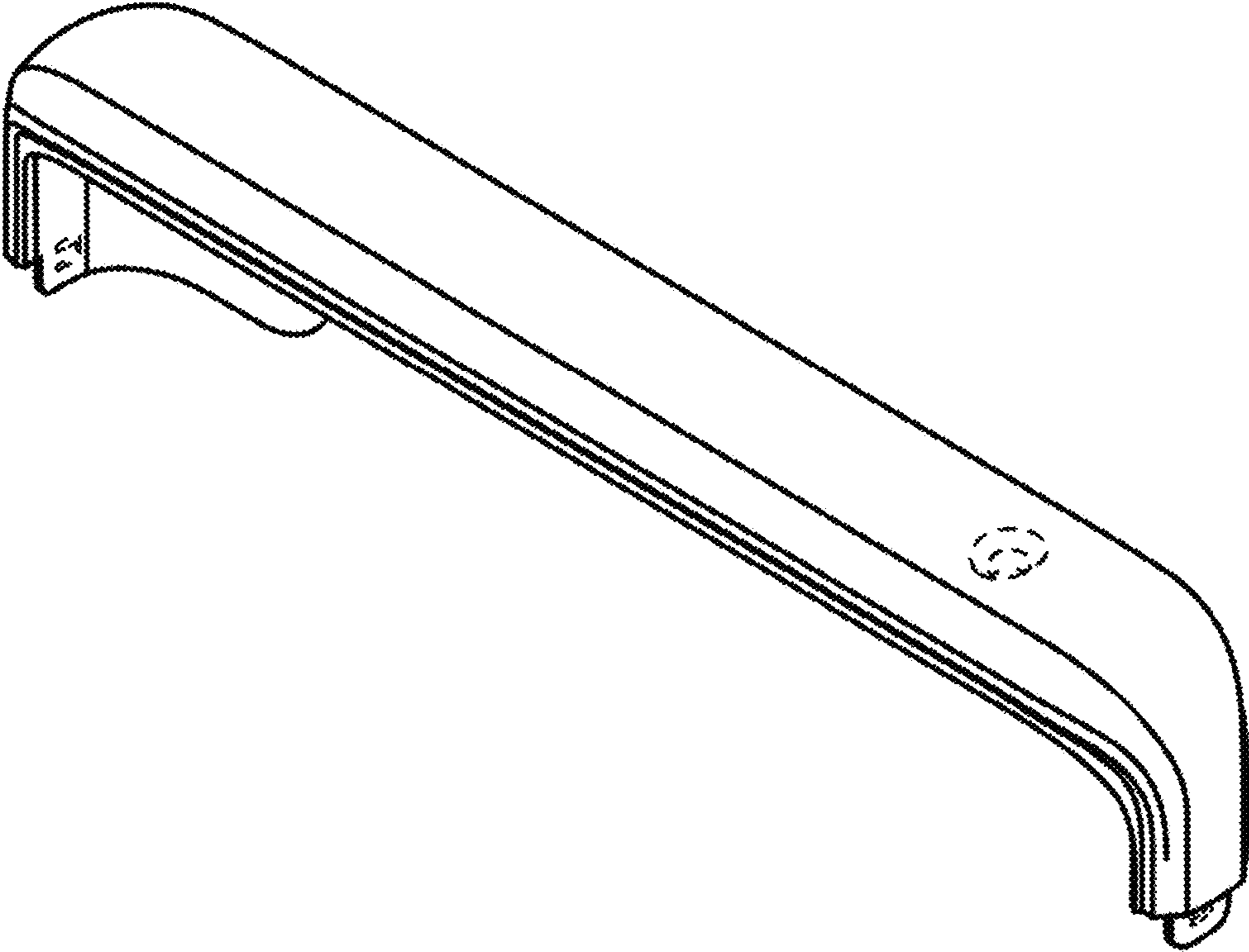

FIG. 10

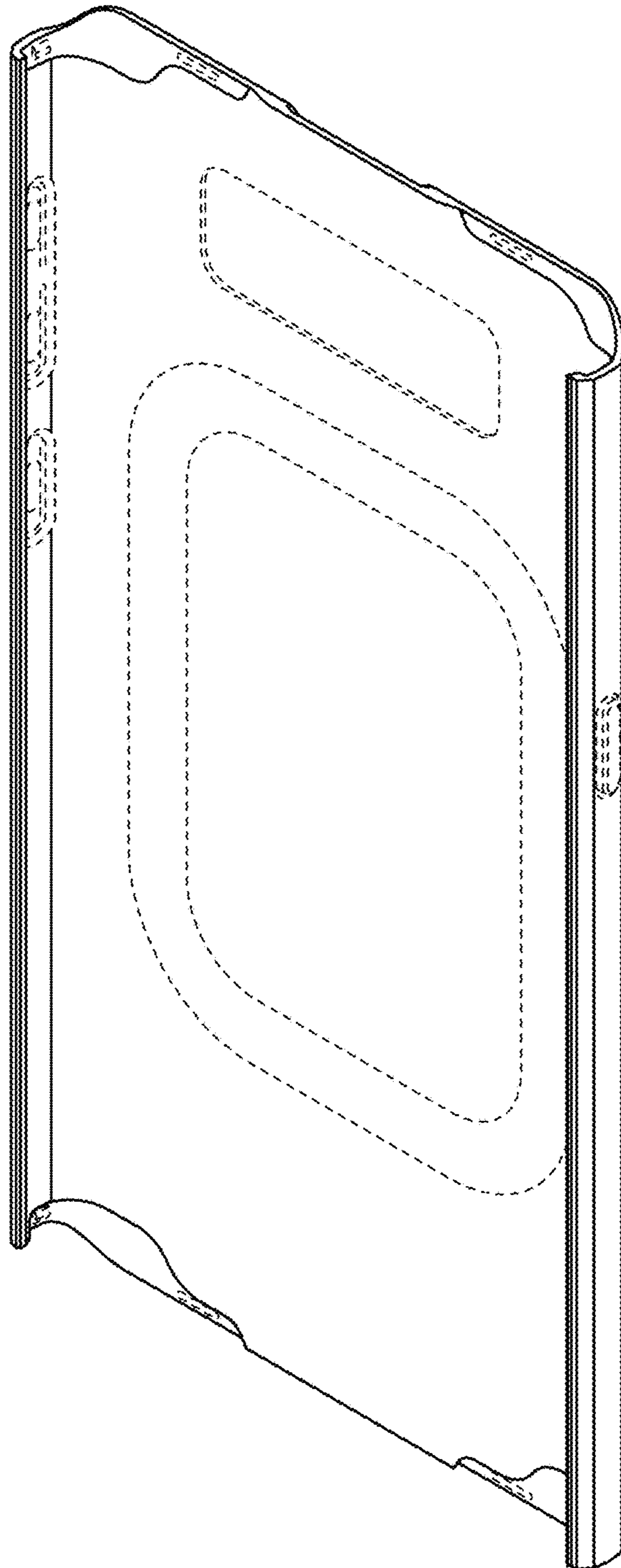

FIG. 11

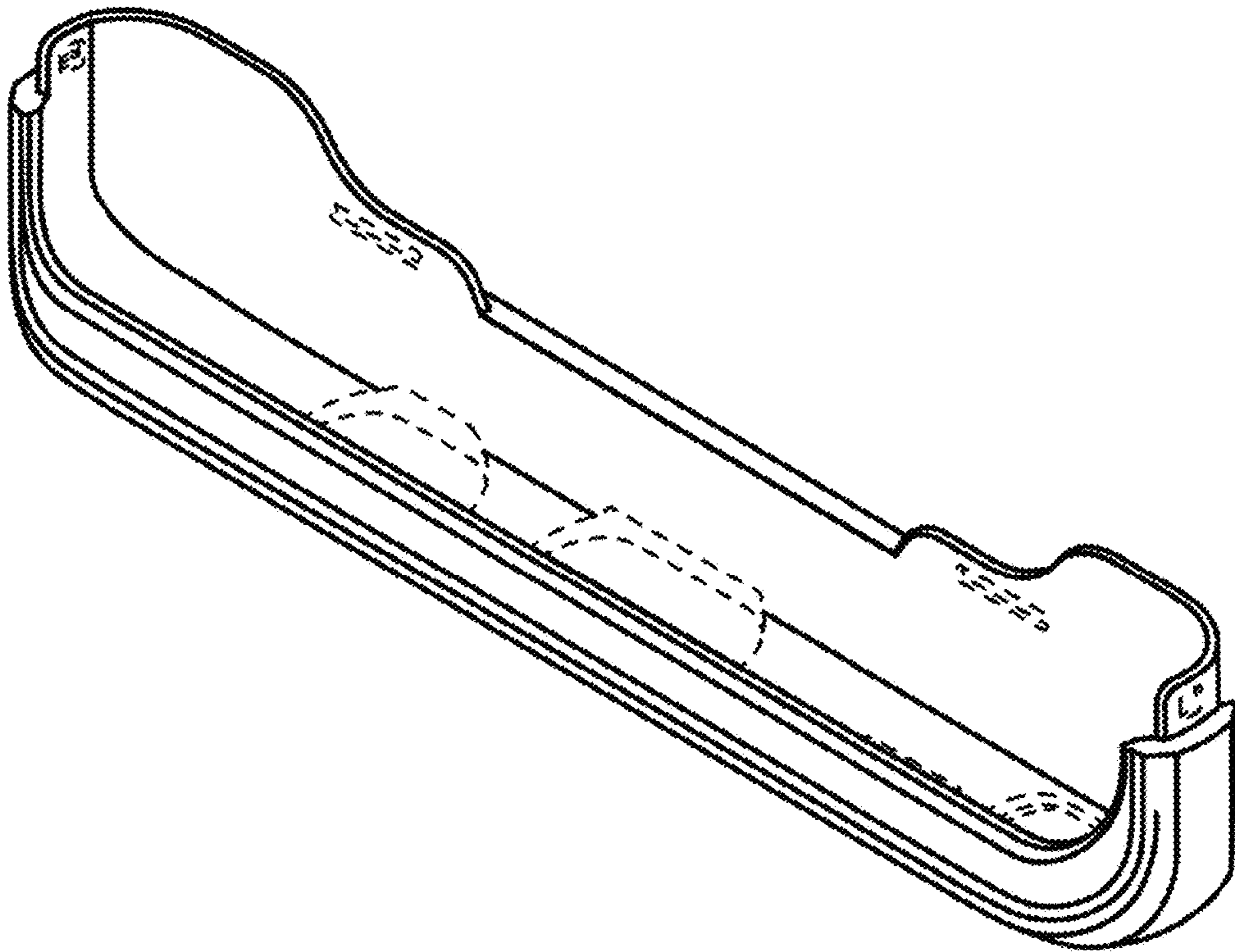

FIG. 12

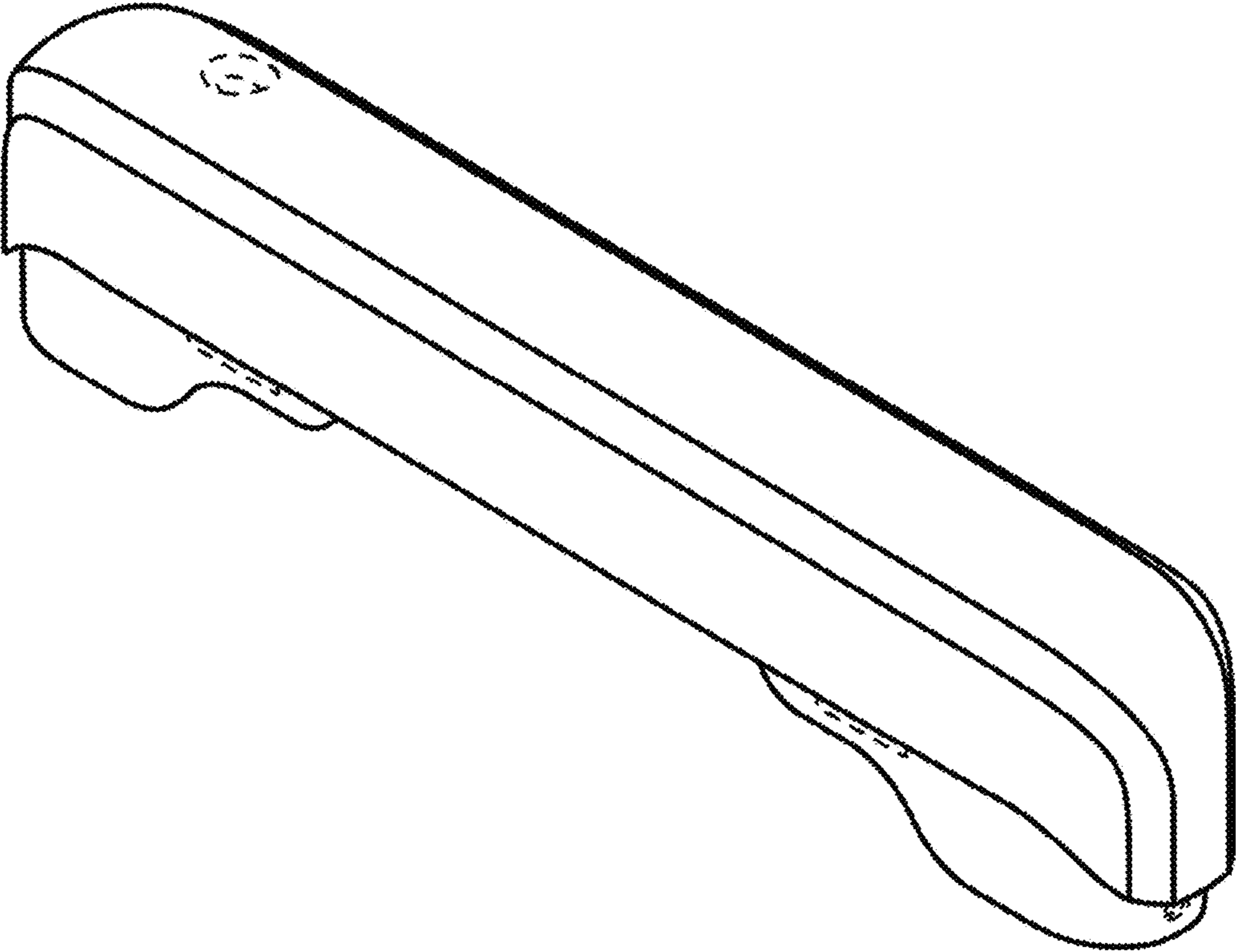

FIG. 13

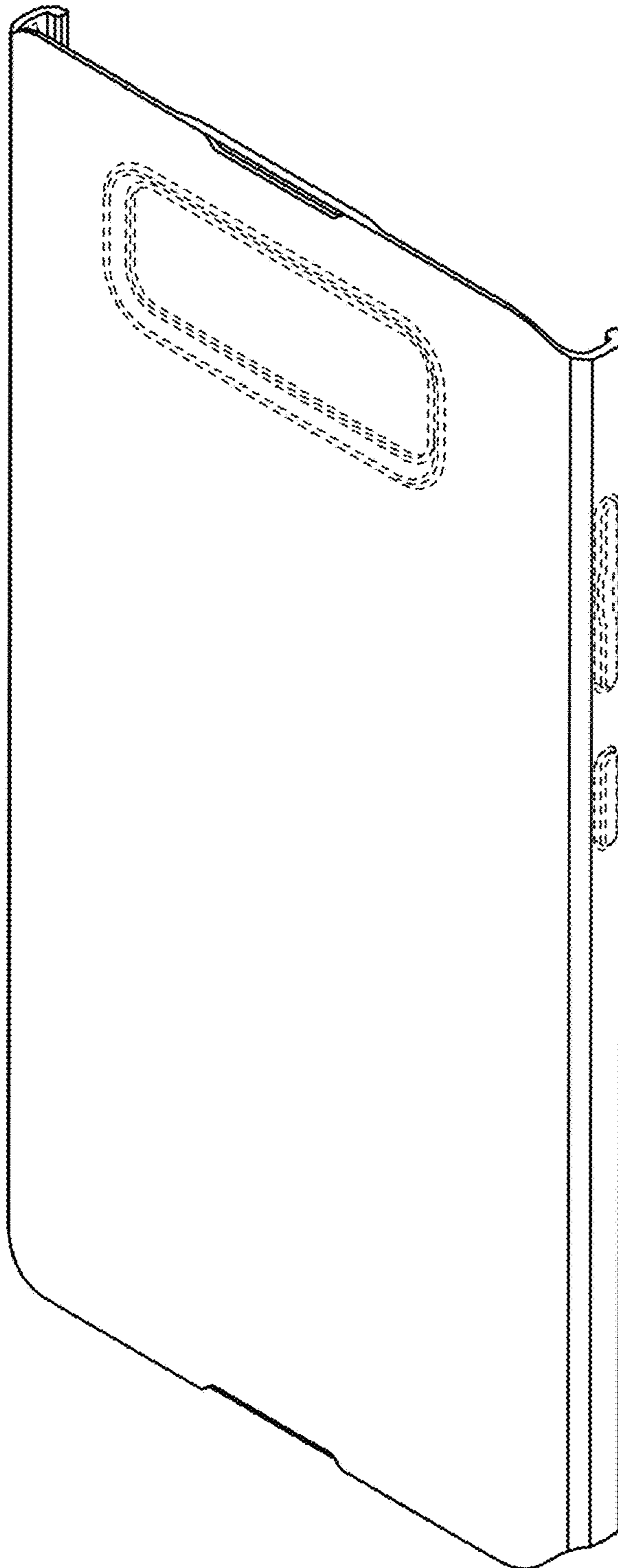

FIG. 14

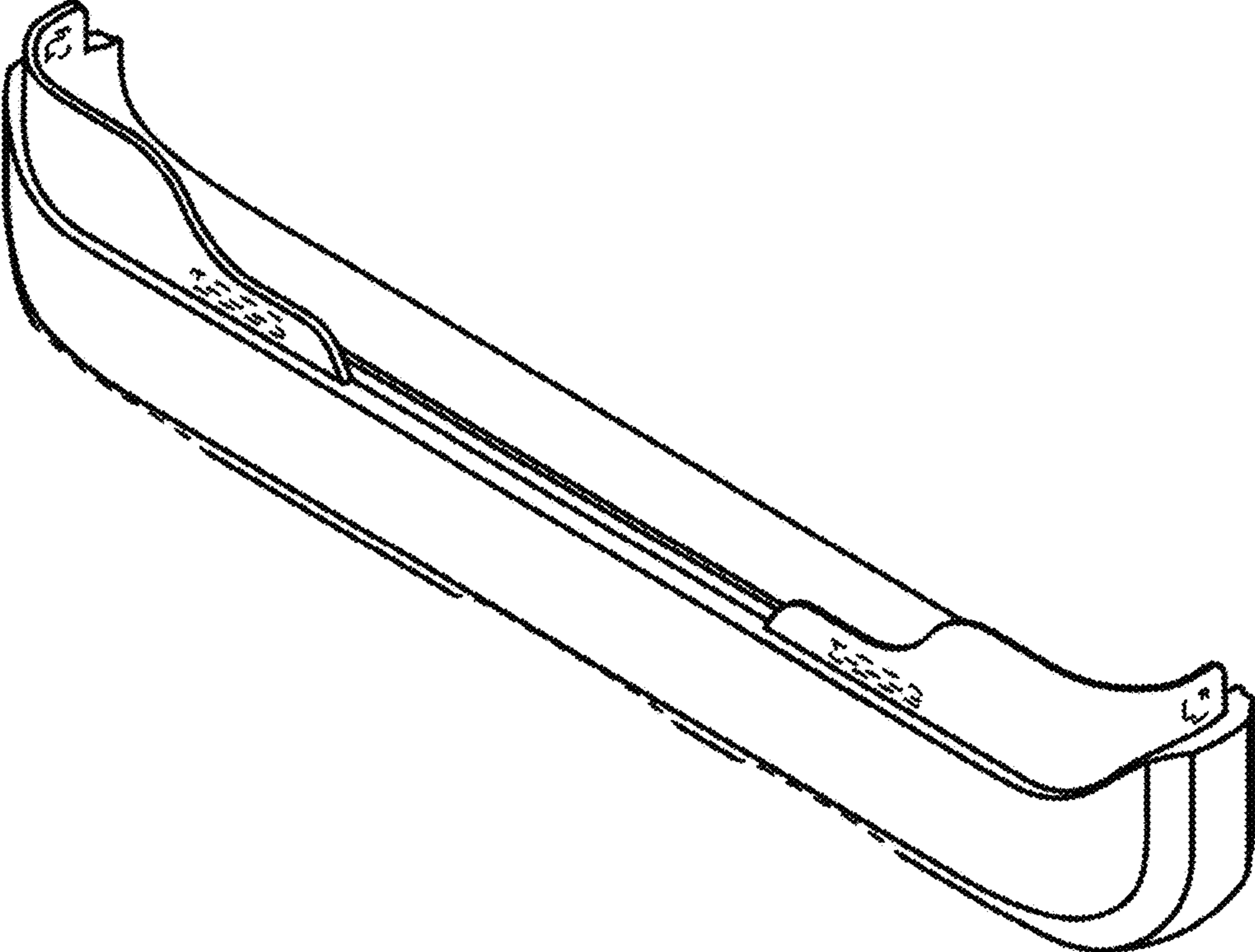



FIG. 15

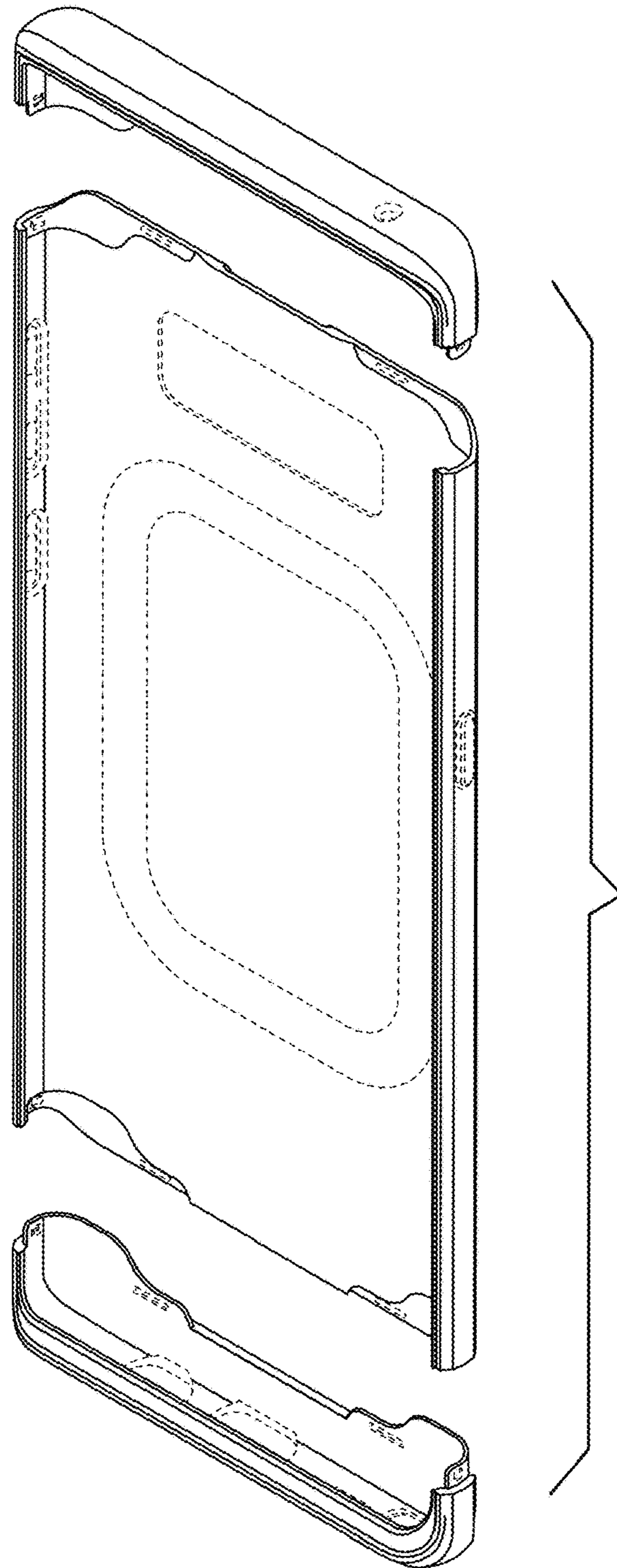

FIG. 16

