



US00D833399S

(12) **United States Design Patent** (10) **Patent No.:** **US D833,399 S**  
**Bdeir** (45) **Date of Patent:** **\*\* Nov. 13, 2018**

(54) **CONNECTOR FOR MODULAR ELECTRONIC BUILDING SYSTEM**

(71) Applicant: **littleBits Electronics Inc.**, New York, NY (US)

(72) Inventor: **Aya Bdeir**, New York, NY (US)

(73) Assignee: **littleBits Electronics Inc.**, New York, NY (US)

(\*\*) Term: **15 Years**

(21) Appl. No.: **29/638,279**

(22) Filed: **Feb. 26, 2018**

**Related U.S. Application Data**

(62) Division of application No. 29/559,422, filed on Mar. 28, 2016, now Pat. No. Des. 811,339, which is a division of application No. 29/530,983, filed on Jun. 22, 2015, now Pat. No. Des. 752,519, which is a division of application No. 29/437,623, filed on Nov. 19, 2012, now Pat. No. Des. 732,475.

(51) **LOC (11) Cl.** ..... **13-03**

(52) **U.S. Cl.**  
USPC ..... **D13/146**

(58) **Field of Classification Search**  
USPC ..... D13/146, 147, 154, 184, 199; D21/398  
CPC . H01R 9/03; H01R 9/09; H01R 9/091; H01R 9/096; H01R 9/097; H01R 9/098; H05K 5/00; H05K 7/00; H05K 11/30; A63H 3/04; A63H 3/006; A63H 3/16  
See application file for complete search history.

(56) **References Cited**

**U.S. PATENT DOCUMENTS**

4,878,848 A \* 11/1989 Ingalsbe ..... H01R 31/06  
439/638  
D658,586 S \* 5/2012 Lin ..... D13/146  
D732,475 S \* 6/2015 Bdeir ..... D13/146  
2007/0173095 A1 \* 7/2007 Bin-Nun ..... A63H 33/108  
439/219

(Continued)

**OTHER PUBLICATIONS**

Building blocks that blink, beep and teach, Posted Feb. 2012, by Editors TED Talks, [online], [site visited Jun. 6, 2018]. Available from Internet, <URL: [http://www.ted.com/talks/ayah\\_bdeir\\_building\\_blocks\\_that\\_blink\\_beep\\_and\\_teach](http://www.ted.com/talks/ayah_bdeir_building_blocks_that_blink_beep_and_teach)> (Year: 2012).\*

*Primary Examiner* — Michelle E. Wilson

*Assistant Examiner* — Sanjeev Paul

(74) *Attorney, Agent, or Firm* — Cooley LLP

(57) **CLAIM**

The ornamental design for a connector for a modular electronic building system, as shown and described.

**DESCRIPTION**

FIG. 1 is a bottom perspective view of a connector for a modular electronic building system, according to an embodiment;

FIG. 2 is a front view of the connector for a modular electronic building system illustrated in FIG. 1;

FIG. 3 is a rear view of the connector for a modular electronic building system illustrated in FIG. 1;

FIG. 4 is a left side view of the connector for a modular electronic building system illustrated in FIG. 1;

FIG. 5 is a right side view of the connector for a modular electronic building system illustrated in FIG. 1;

FIG. 6 is a bottom view of the connector for a modular electronic building system illustrated in FIG. 1; and,

FIG. 7 is a top view of the connector for a modular electronic building system illustrated in FIG. 1.

The broken lines in the figures show disclaimed portions of the connector for modular electronic building system; the broken lines form no part of the claimed design.

**1 Claim, 4 Drawing Sheets**

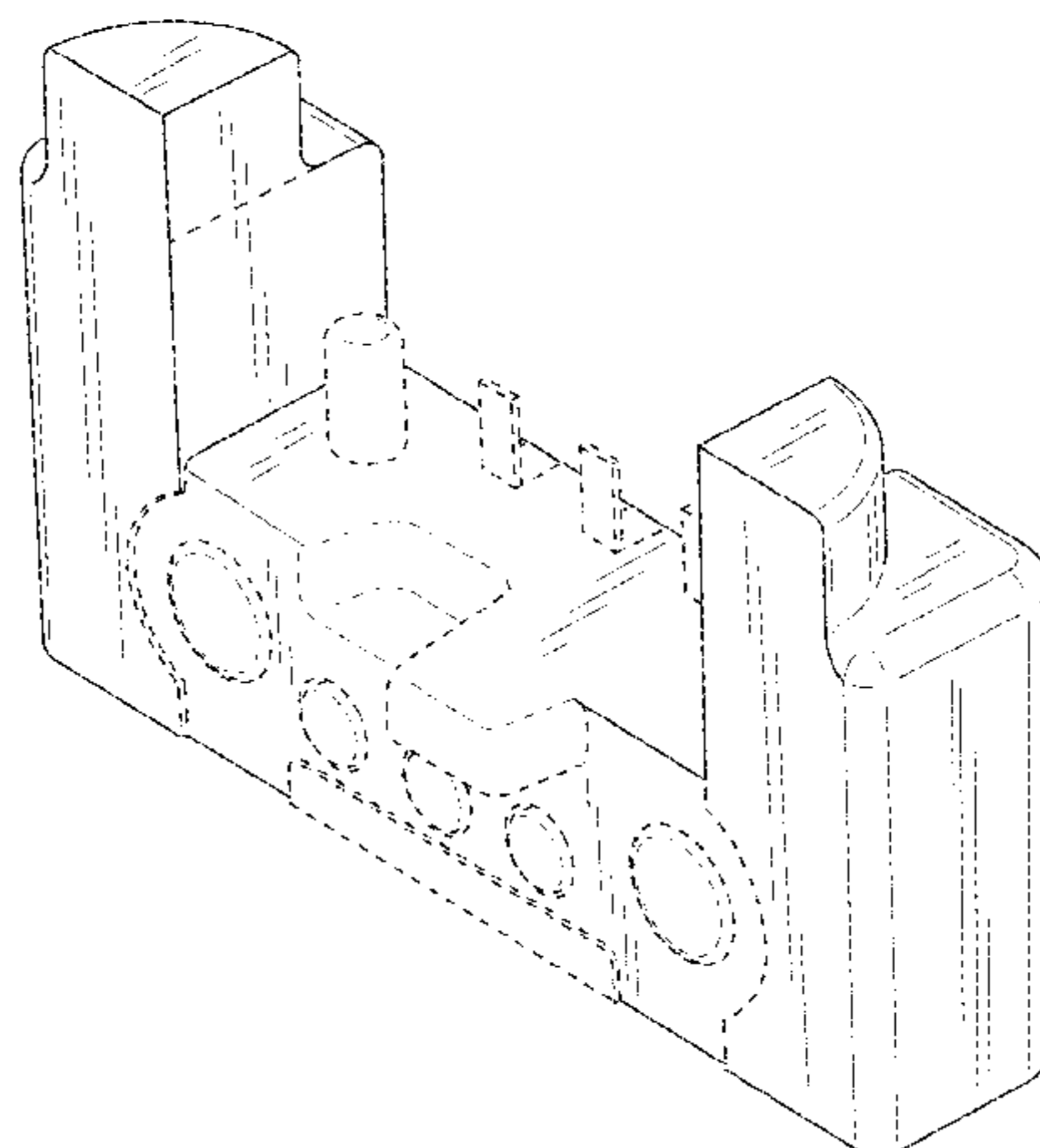

(56)

**References Cited**

U.S. PATENT DOCUMENTS

2008/0166926 A1\* 7/2008 Seymour ..... E04B 2/06  
439/701  
2010/0151738 A1\* 6/2010 Chou ..... G06T 17/10  
439/638  
2010/0311300 A1\* 12/2010 Hansen ..... A63H 33/042  
446/91  
2011/0263145 A1\* 10/2011 Kim ..... H01R 13/4534  
439/137  
2013/0050958 A1\* 2/2013 Bdeir ..... H01R 13/6205  
361/730  
2013/0343025 A1\* 12/2013 Bdeir ..... H01R 13/6205  
361/803  
2014/0038466 A1\* 2/2014 Karodi ..... H01R 13/514  
439/626

\* cited by examiner

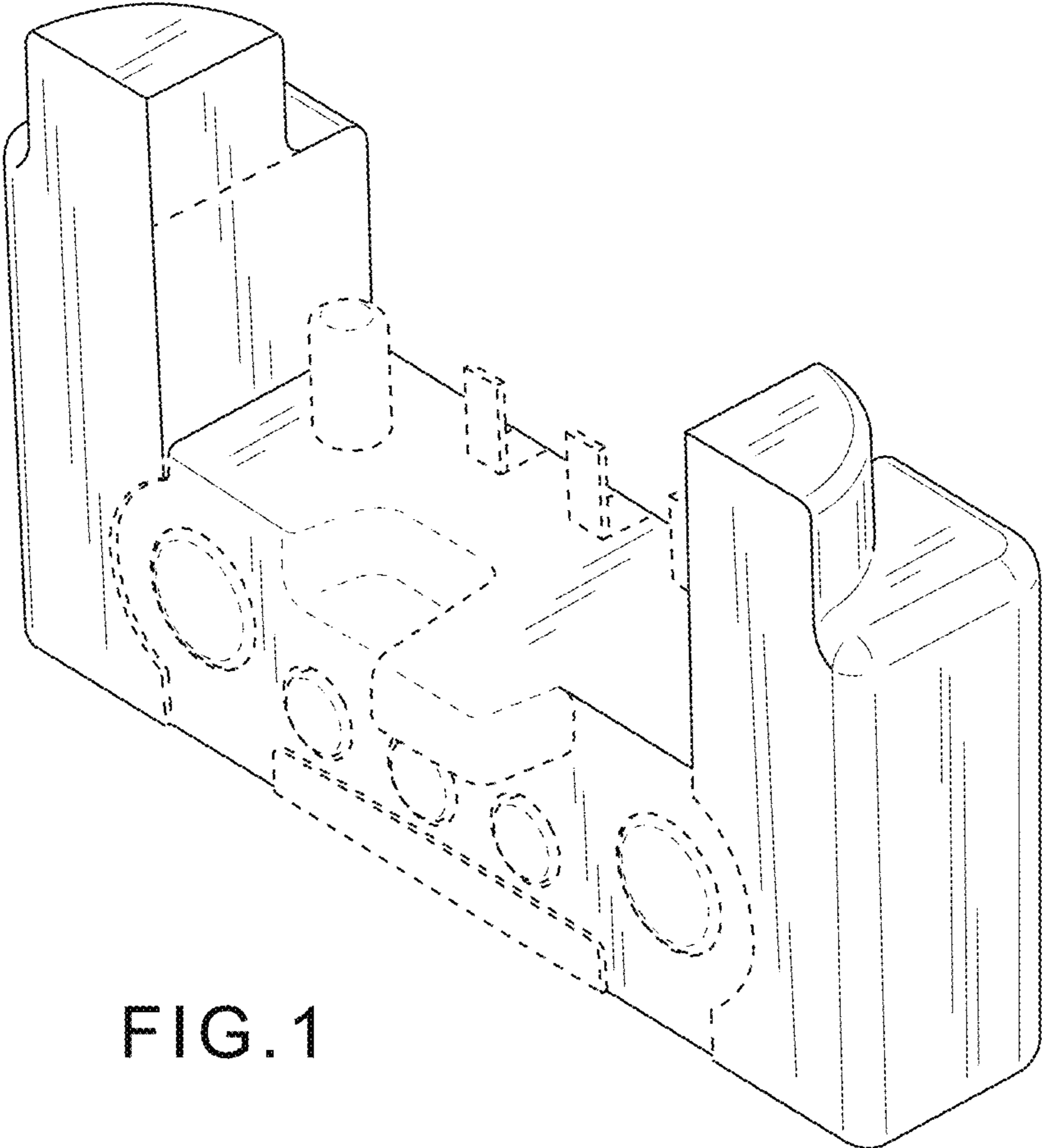

FIG. 1

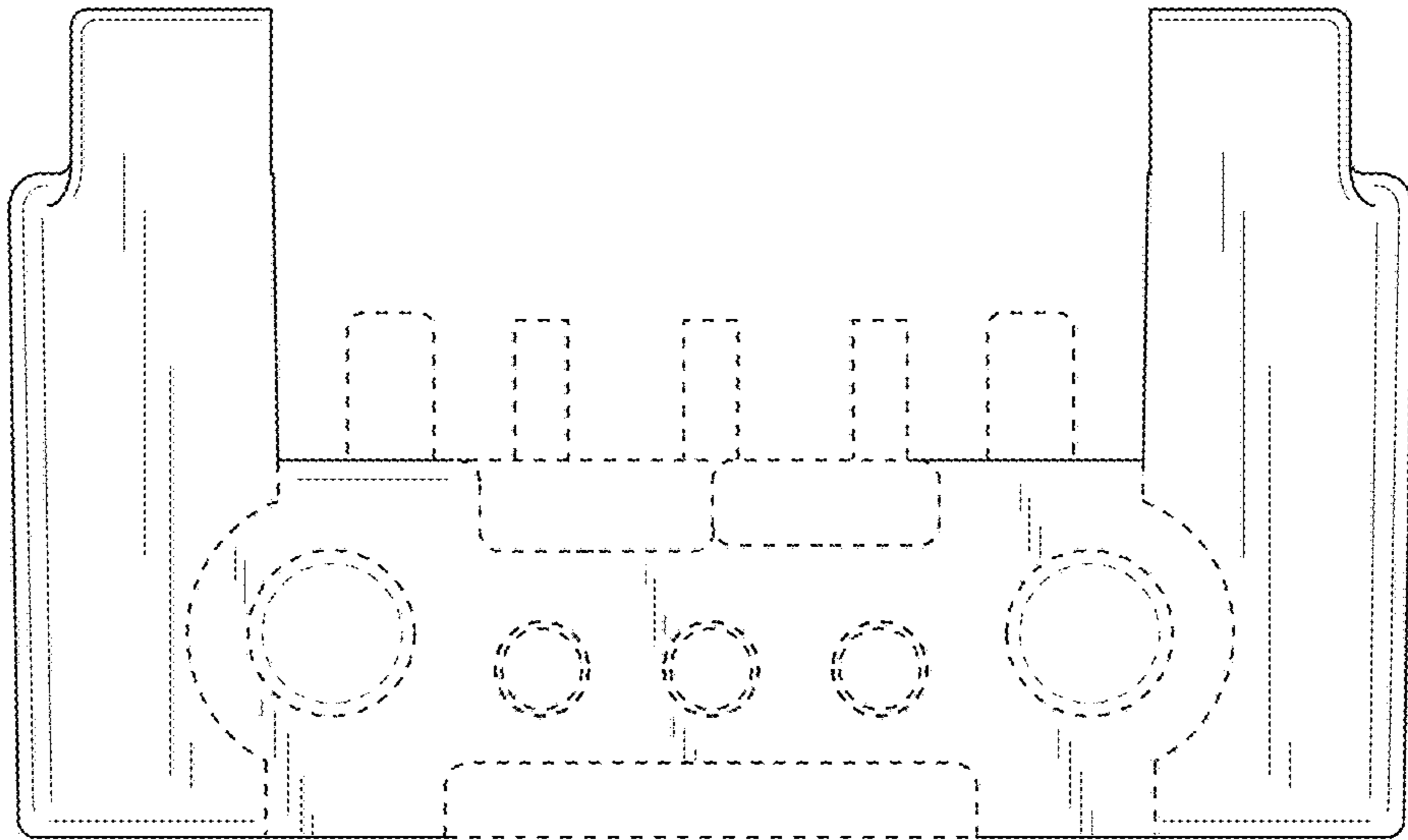

FIG. 2

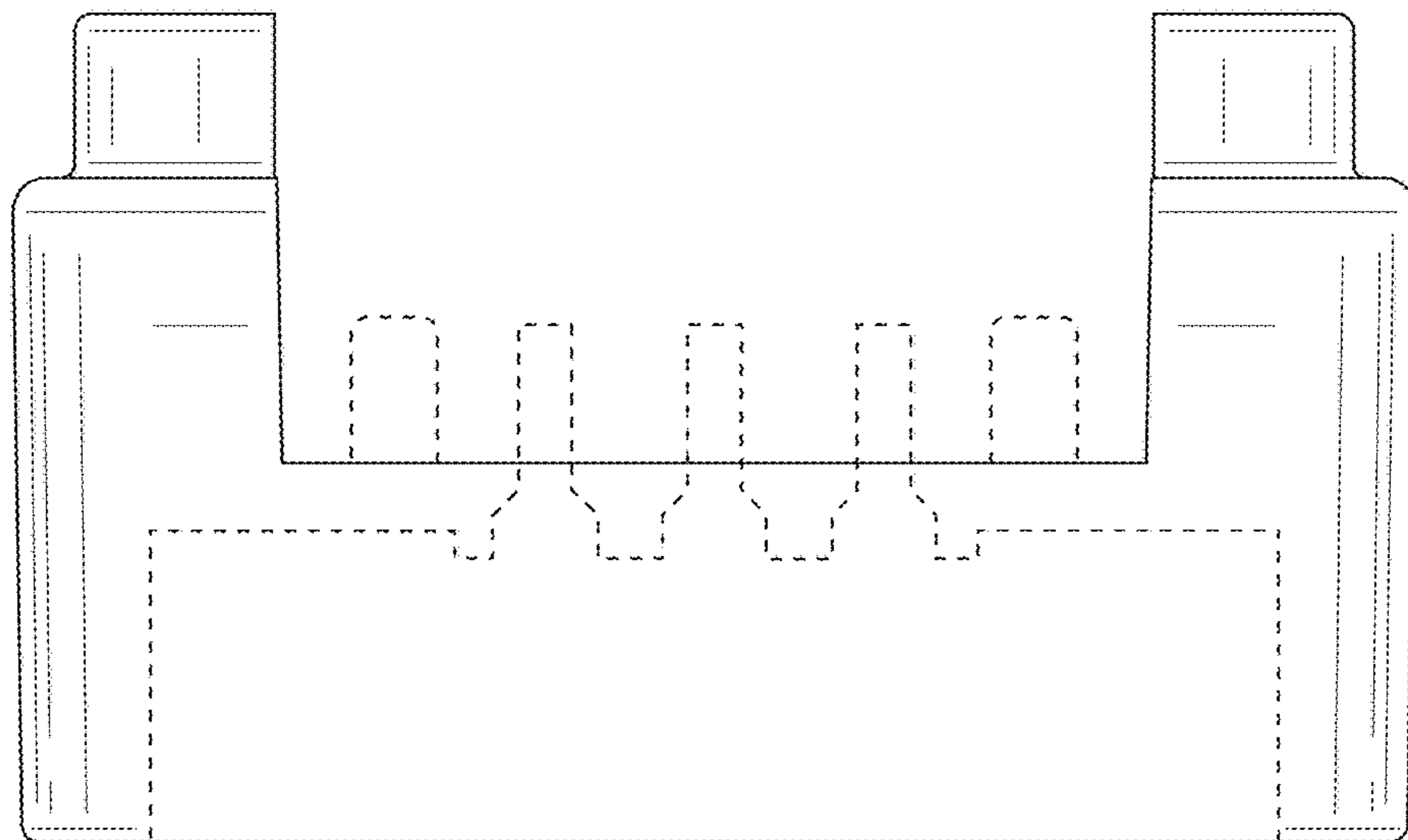

FIG. 3

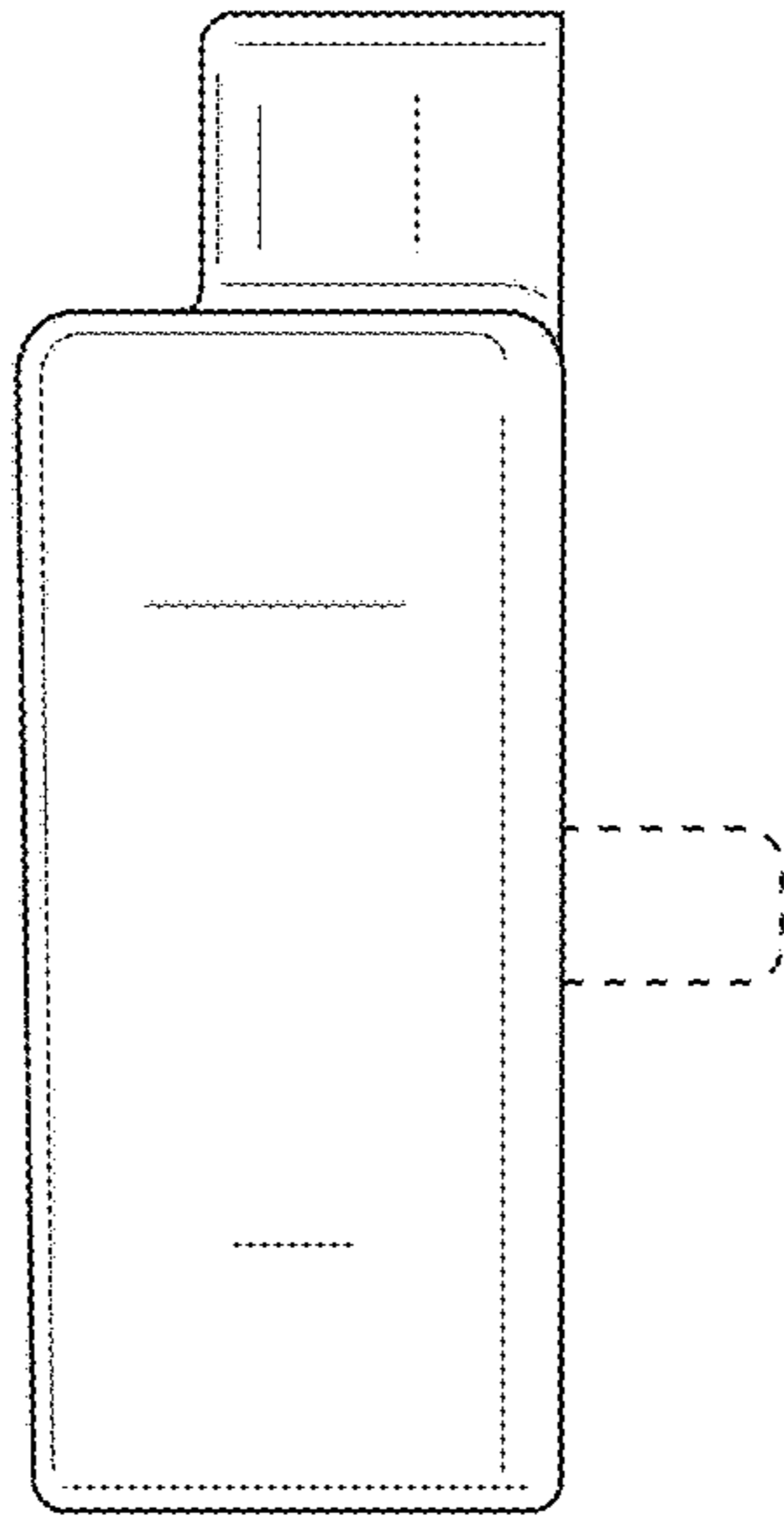

FIG. 4

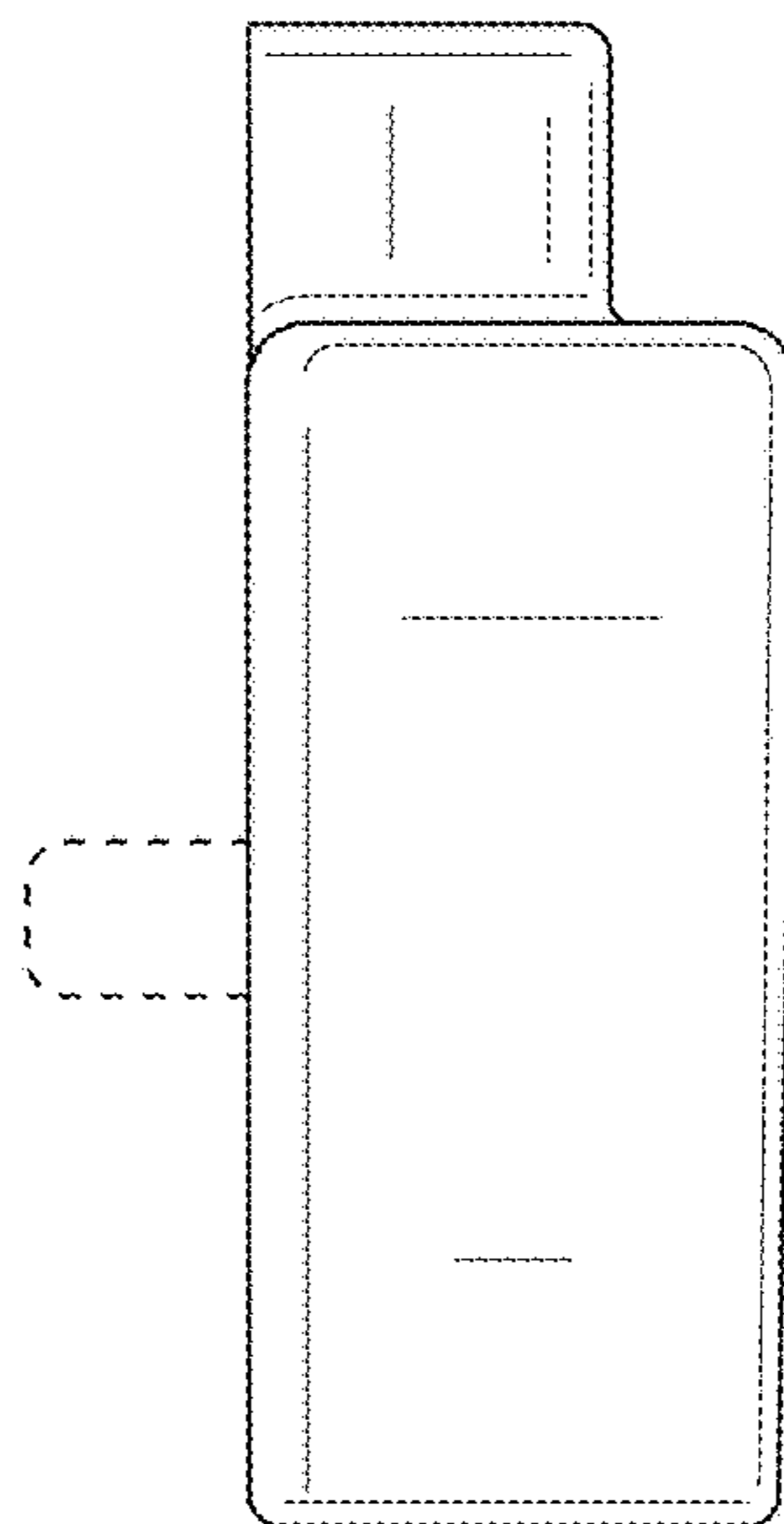

FIG. 5

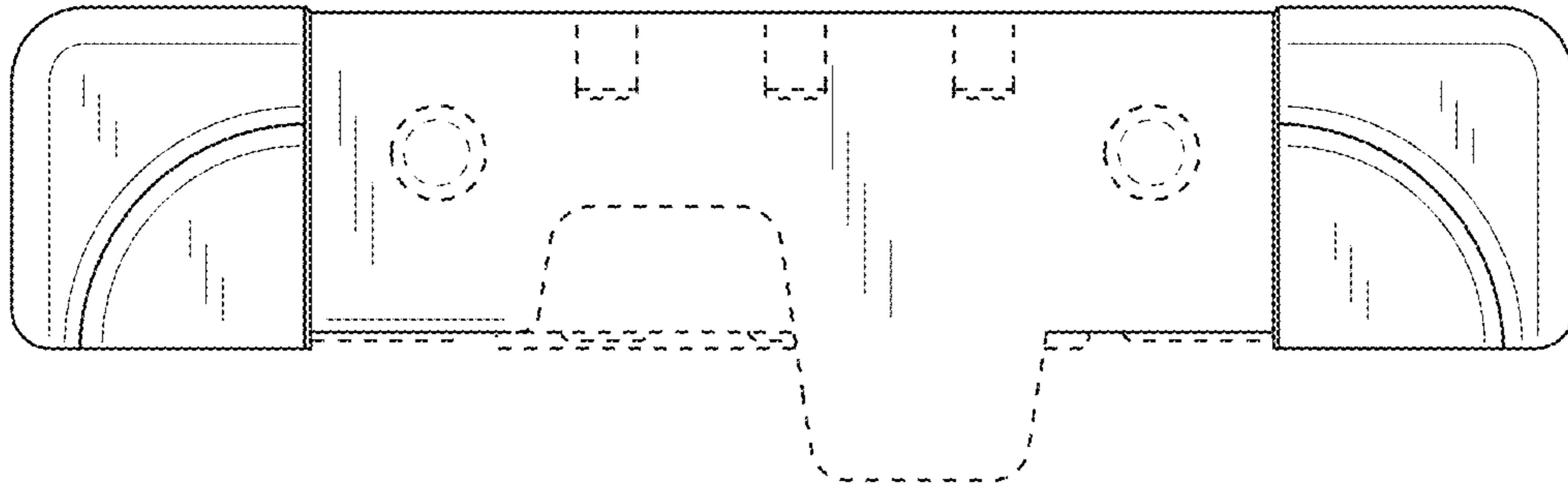

FIG. 6

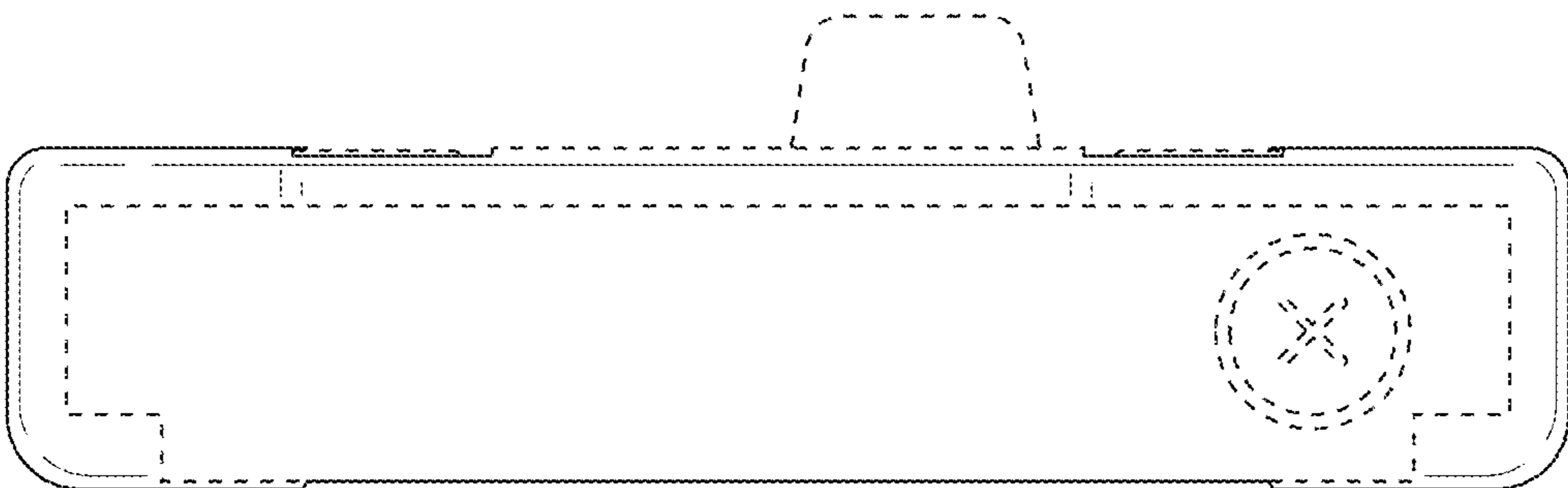

FIG. 7