



US00D833309S

(12) **United States Design Patent** (10) **Patent No.:** **US D833,309 S**
Baick (45) **Date of Patent:** **** Nov. 13, 2018**

(54) **WHEEL BALANCE WEIGHT**
(71) Applicant: **Pal Sung Baick**, Gyeonggi-do (KR)
(72) Inventor: **Pal Sung Baick**, Gyeonggi-do (KR)
(73) Assignee: **Pal Sung Baick**, Gyeonggi-do (KR)
(**) Term: **15 Years**
(21) Appl. No.: **29/604,770**
(22) Filed: **May 19, 2017**

D709,779 S * 7/2014 Burgel D10/94
D710,225 S * 8/2014 Burgel D10/94
D729,666 S * 5/2015 Burgel D10/94
D754,012 S * 4/2016 Vogler D10/94

* cited by examiner

Primary Examiner — Antoine Duval Davis
(74) *Attorney, Agent, or Firm* — Frank Rosenberg

(30) **Foreign Application Priority Data**

Dec. 27, 2016 (KR) 30-2016-0063476

(51) **LOC (11) Cl.** **10-04**

(52) **U.S. Cl.**
USPC **D10/94**

(58) **Field of Classification Search**
USPC D10/87, 88, 89, 90, 91, 92, 93, 94;
D21/385, 391, 491, 680
CPC F16F 15/32; F16F 15/322; F16F 15/324;
F16F 15/326; F16F 15/328; F16F 15/34;
F16F 15/345; F16F 15/36; F16F 15/363;
F16F 15/366; G01G 1/32; G01G 1/34;
G01G 21/26
See application file for complete search history.

(56) **References Cited**

U.S. PATENT DOCUMENTS

6,874,856 B2 * 4/2005 Yoshimura et al. F15F 15/32
7,044,561 B2 * 5/2006 Petchel F16F 15/328
301/5.21

(57) **CLAIM**

I claim, the ornamental design for a wheel balance weight, as shown and described.

DESCRIPTION

FIG. 1 is a perspective view of a wheel balance weight showing my new design;
FIG. 2 is a front elevational view thereof,
FIG. 3 is a rear elevational view thereof,
FIG. 4 is a left side elevational view thereof,
FIG. 5 is a right side elevational view thereof,
FIG. 6 is a top plan view thereof;
FIG. 7 is a bottom plan view thereof.
FIG. 8 is an enlarged top view thereof taken from part A in FIG. 6; and,
FIG. 9 is an enlarged cross sectional view thereof taken along the line B-B in FIG. 8.

1 Claim, 9 Drawing Sheets

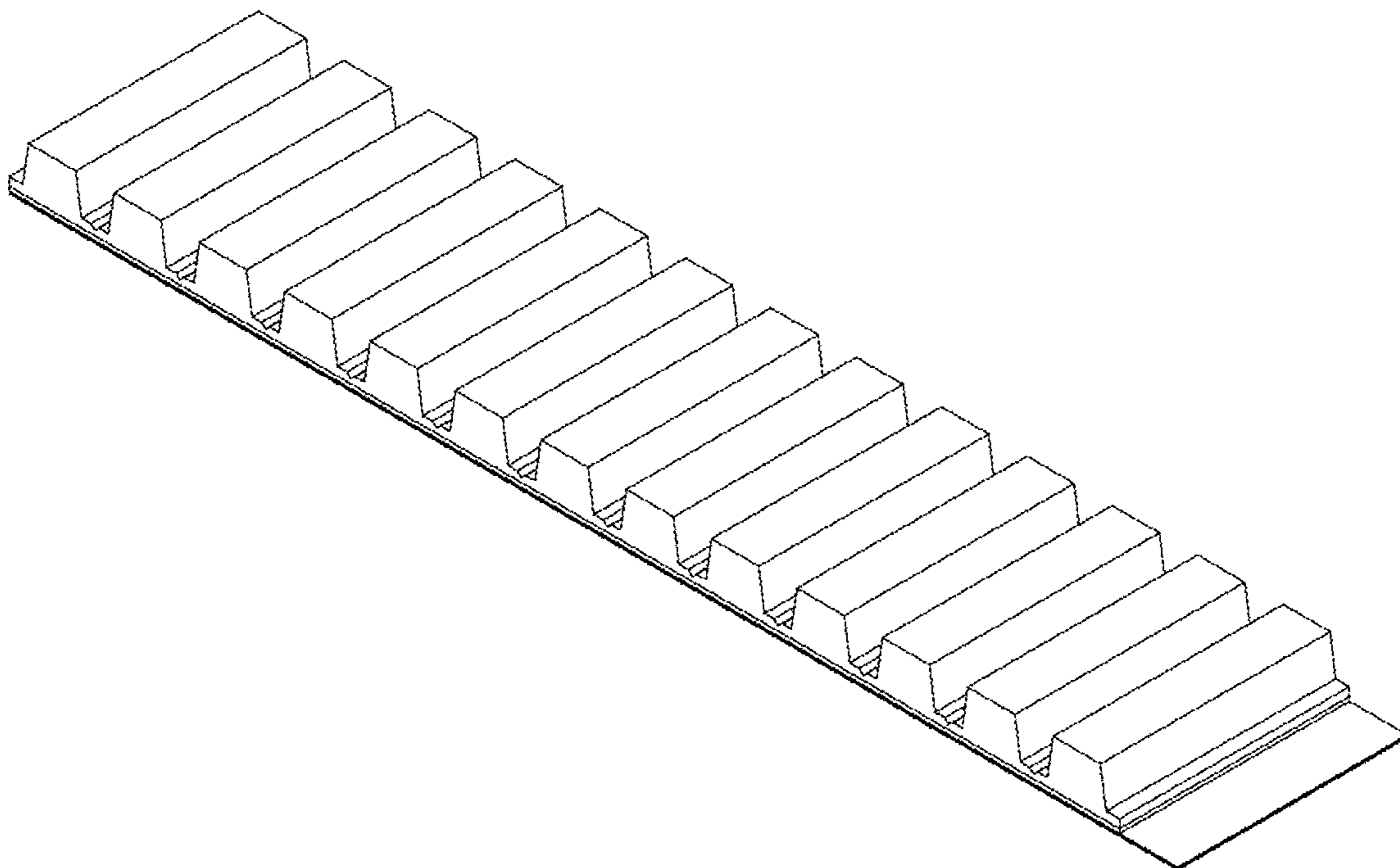

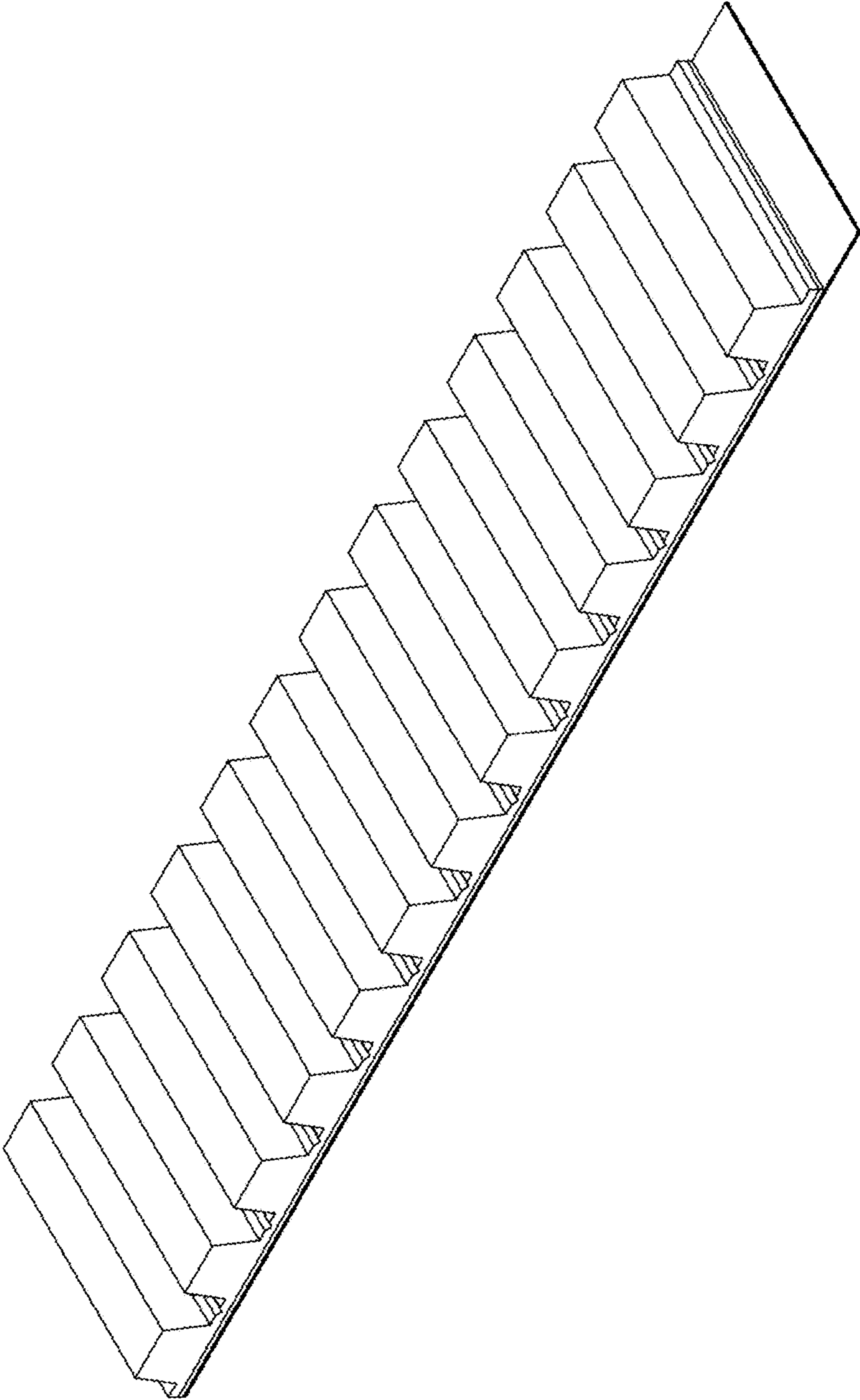

Fig. 1

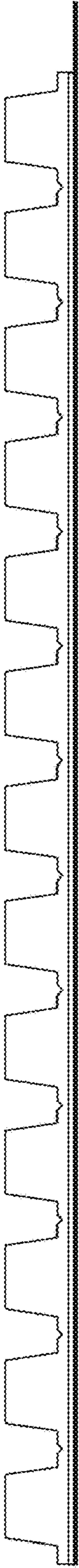

Fig. 2



Fig. 3

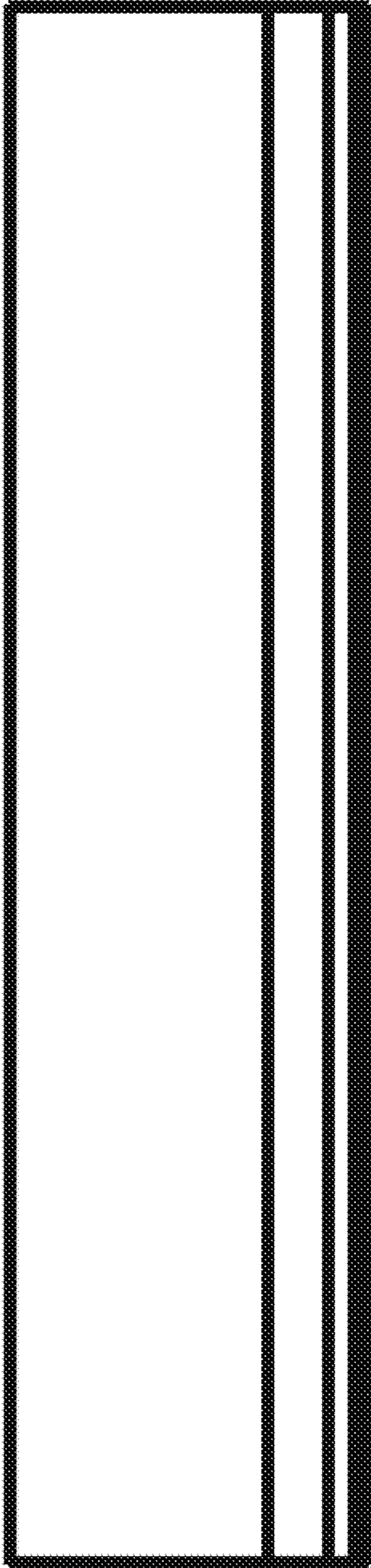

Fig. 4

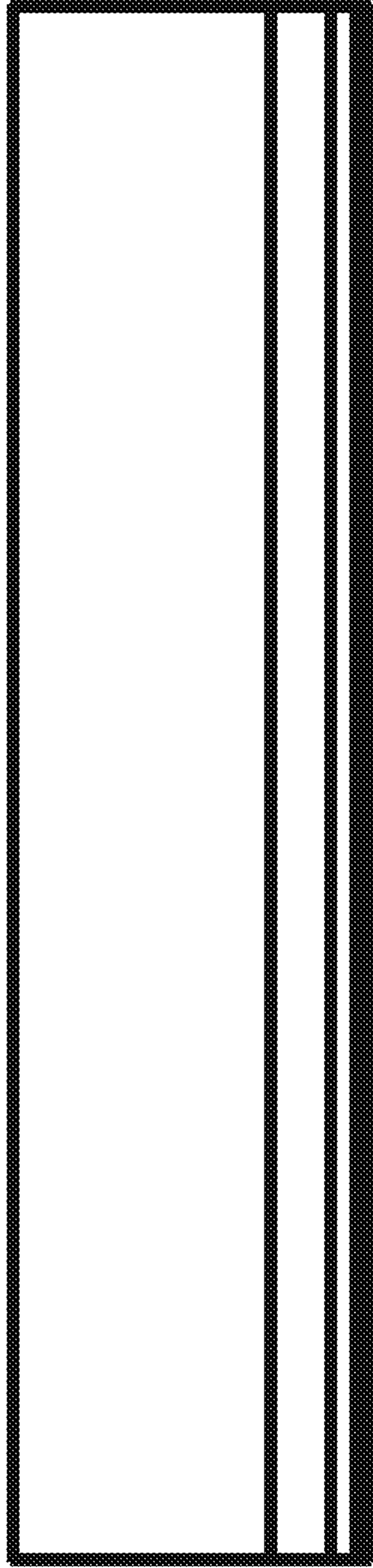

Fig. 5

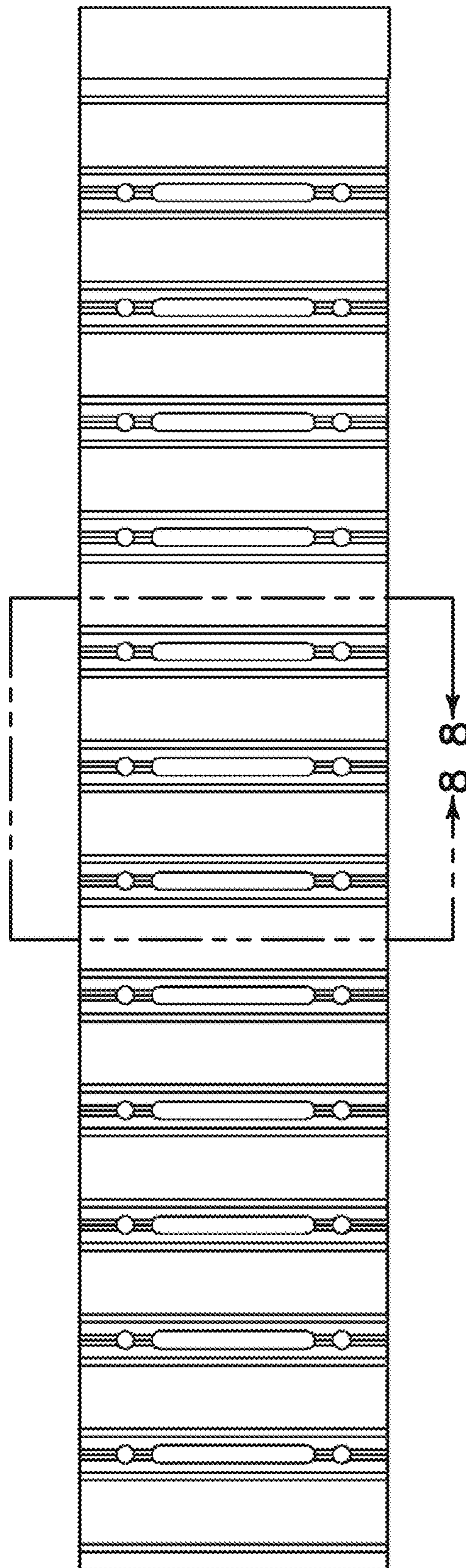

Fig. 6

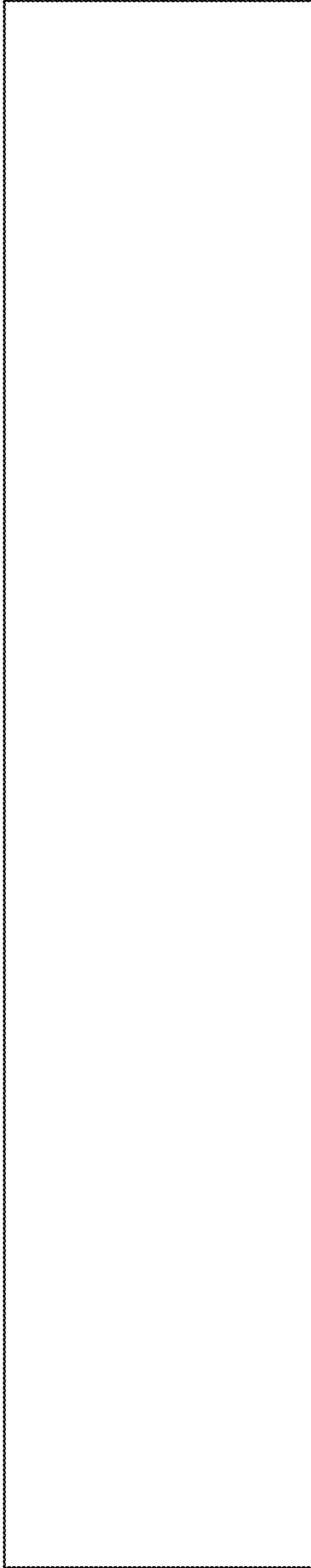

Fig. 7

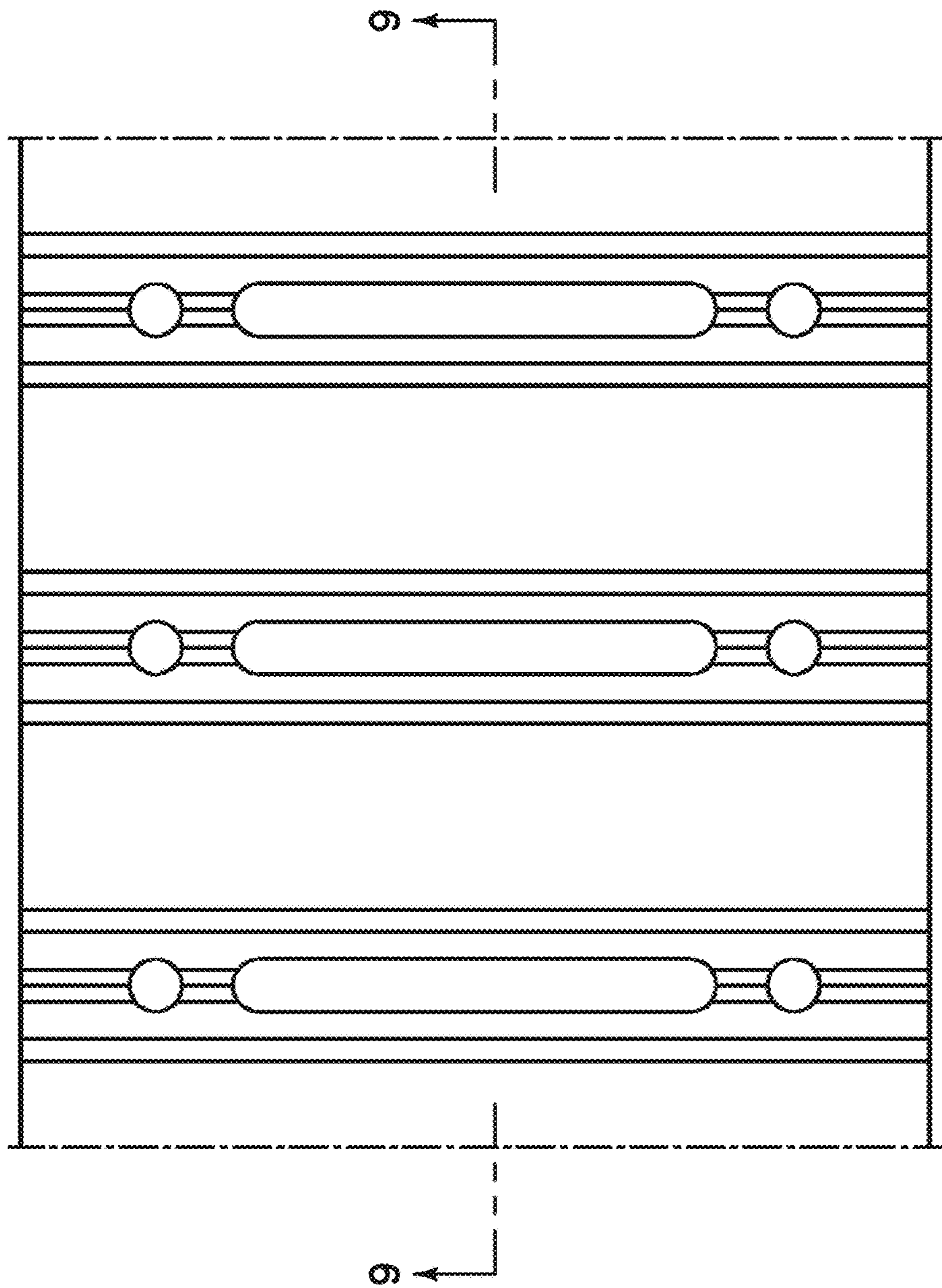

Fig. 8

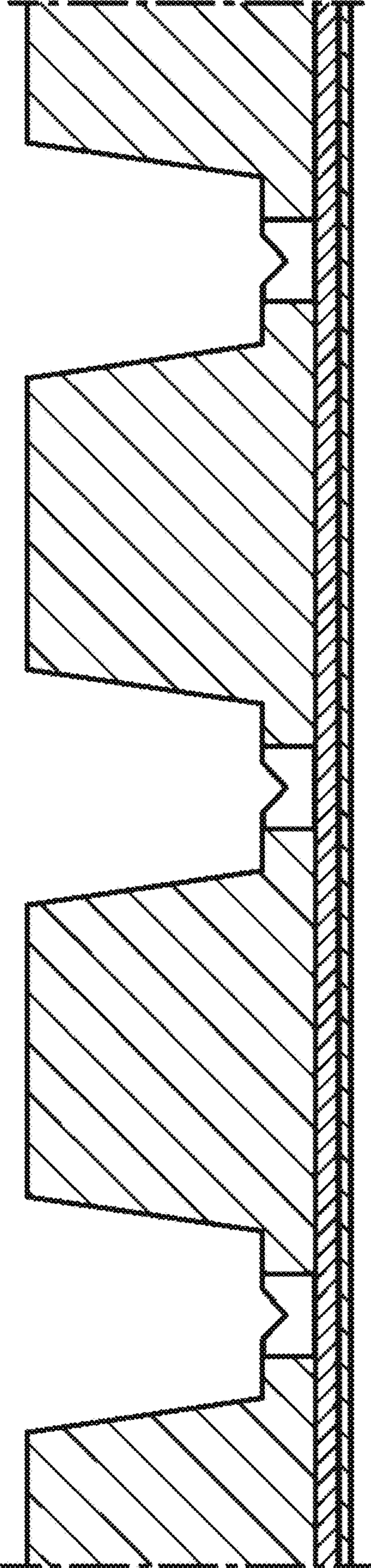

Fig. 9