



US00D833210S

(12) **United States Design Patent** (10) **Patent No.:** **US D833,210 S**  
**Hill** (45) **Date of Patent:** **\*\* Nov. 13, 2018**

(54) **TEA PIECE**  
(71) Applicant: **CONTRA VISION LTD.**, Bramhall (GB)  
(72) Inventor: **George Roland Hill**, Bramhall (GB)  
(73) Assignee: **CONTRA VISION LTD.**, Bramhall, Stockport, Cheshire (GB)

(\*\*) Term: **15 Years**

(21) Appl. No.: **29/550,850**

(22) Filed: **Jan. 7, 2016**

**Related U.S. Application Data**

(63) Continuation-in-part of application No. PCT/IB2015/055147, filed on Jul. 7, 2015.

(51) **LOC (11) Cl.** ..... **07-02**

(52) **U.S. Cl.**  
USPC ..... **D7/391**

(58) **Field of Classification Search**  
USPC ..... D7/323, 354-363, 391, 393-396, 409, D7/505, 507, 510

(Continued)

(56) **References Cited**

**U.S. PATENT DOCUMENTS**

3,288,344 A 11/1966 Woollen et al.  
3,362,590 A 1/1968 Martin

(Continued)

**FOREIGN PATENT DOCUMENTS**

FR 2527917 12/1983  
GB 2121673 1/1984

(Continued)

**OTHER PUBLICATIONS**

Written Opinion of the International Preliminary Examining Authority issued in corresponding International Patent Application No. PCT/IB2015/055147 dated May 31, 2016 (6 pages).

(Continued)

*Primary Examiner* — Ricky Pham  
(74) *Attorney, Agent, or Firm* — Pillsbury Winthrop Shaw Pittman LLP

(57) **CLAIM**

The ornamental design for a tea piece, as shown and described.

**DESCRIPTION**

FIG. 1 is a top perspective view of a first embodiment of the tea piece;

FIG. 2 is a bottom perspective view thereof;

FIG. 3 is a top view thereof;

FIG. 4 is a bottom view thereof;

FIG. 5 is rear view thereof;

FIG. 6 is a front view thereof;

FIG. 7 is a left side view thereof, a right side view thereof being a mirror image;

FIG. 8 is a sectional left side view thereof, taken through a plane of FIG. 3 that bisects the right and left halves of the tea piece, a sectional right side view thereof being a mirror image;

FIG. 9 is a sectional front view thereof, taken through a plane of FIG. 3 that bisects the front and back halves of the tea piece;

FIG. 10 is a top perspective view of a second embodiment of the tea piece;

FIG. 11 is a bottom perspective view thereof;

FIG. 12 is a top view thereof;

FIG. 13 is a bottom view thereof;

FIG. 14 is rear view thereof;

FIG. 15 is a front view thereof;

FIG. 16 is a left side view thereof, a right side view thereof being a mirror image;

FIG. 17 is a sectional left side view thereof, taken through a plane of FIG. 12 that bisects the right and left halves of the tea piece, a sectional right side view thereof being a mirror image;

FIG. 18 is a sectional front view thereof, taken through a plane of FIG. 12 that bisects the front and back halves of the tea piece;

(Continued)

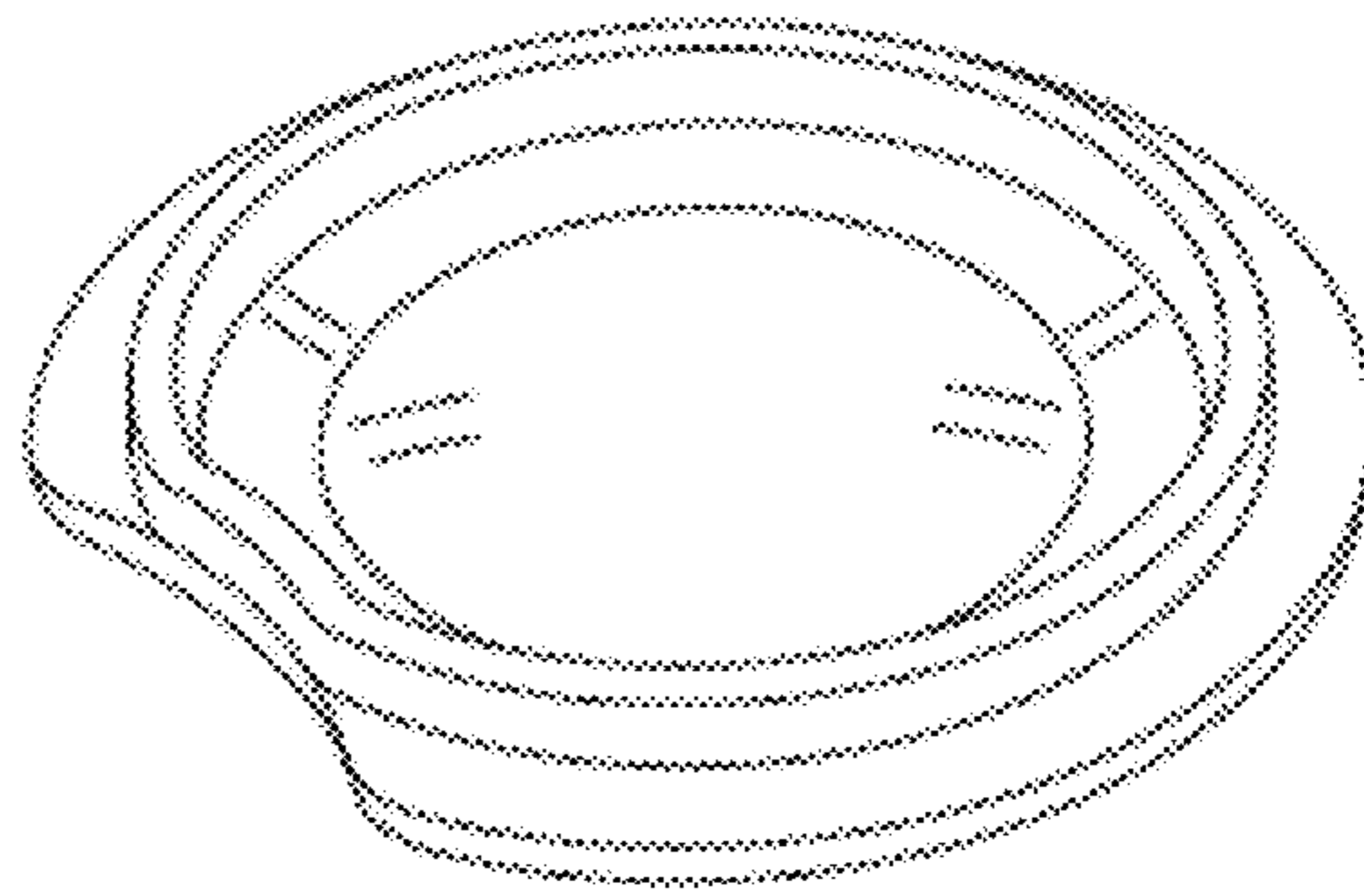
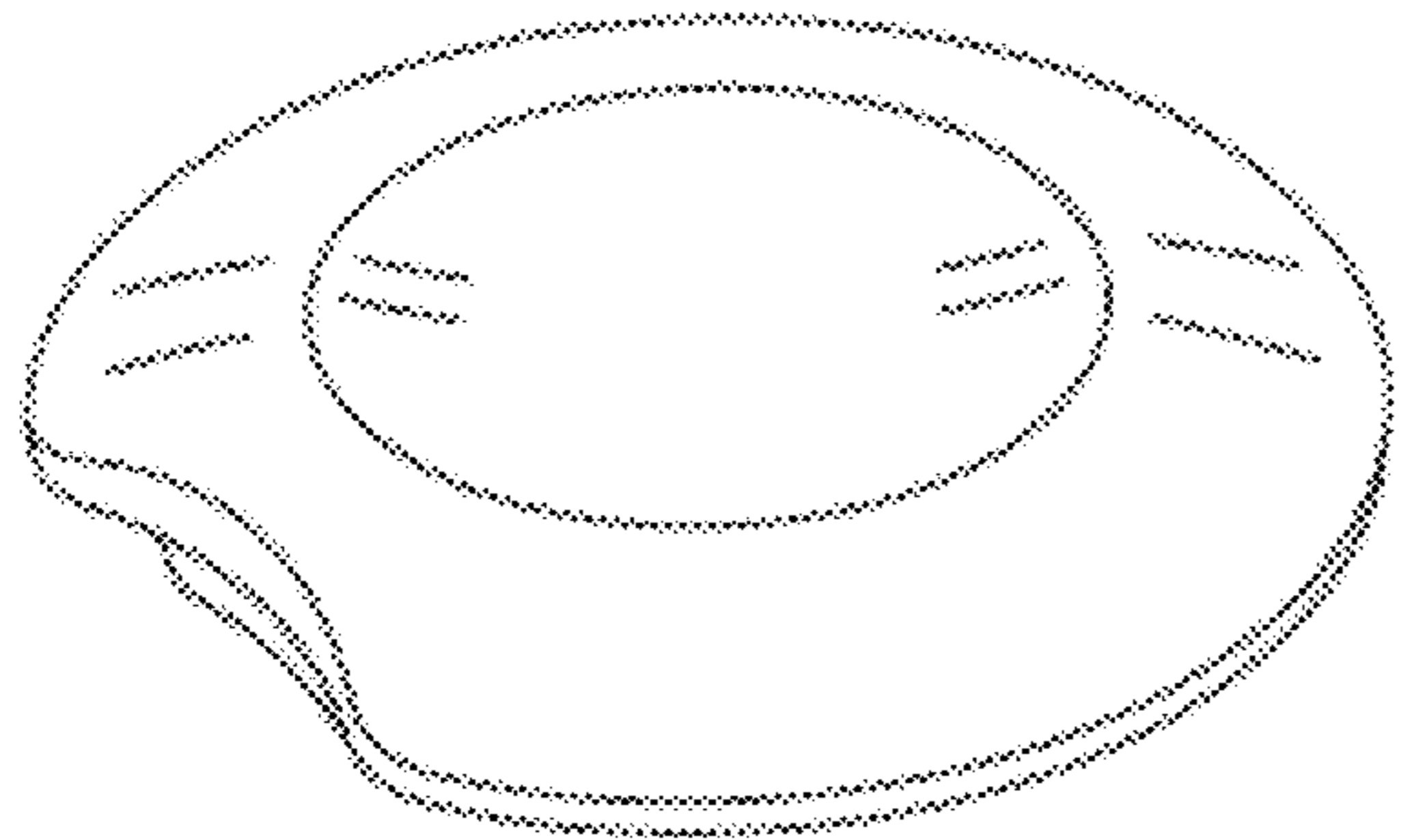



FIG. 19 is a top perspective view of a third embodiment of the tea piece;  
FIG. 20 is a bottom perspective view thereof;  
FIG. 21 is a top view thereof;  
FIG. 22 is a bottom view thereof;  
FIG. 23 is rear view thereof;  
FIG. 24 is a front view thereof;  
FIG. 25 is a left side view thereof, a right side view thereof being a mirror image;  
FIG. 26 is a sectional left side view thereof, taken through a plane of FIG. 21 that bisects the right and left halves of the tea piece, a sectional right side view thereof being a mirror image;  
FIG. 27 is a sectional front view thereof, taken through a plane of FIG. 21 that bisects the front and back halves of the tea piece;  
FIG. 28 is a top perspective view of a fourth embodiment of the tea piece;  
FIG. 29 is a bottom perspective view thereof;  
FIG. 30 is a top view thereof;  
FIG. 31 is a bottom view thereof;  
FIG. 32 is rear view thereof;  
FIG. 33 is a front view thereof;  
FIG. 34 is a left side view thereof, a right side view thereof being a mirror image;  
FIG. 35 is a sectional left side view thereof, taken through a plane of FIG. 30 that bisects the right and left halves of the tea piece, a sectional right side view thereof being a mirror image;  
FIG. 36 is a sectional front view thereof, taken through a plane of FIG. 30 that bisects the front and back halves of the tea piece;  
FIG. 37 is a top perspective view of a fifth embodiment of the tea piece;  
FIG. 38 is a bottom perspective view thereof;  
FIG. 39 is a top view thereof;  
FIG. 40 is a bottom view thereof;  
FIG. 41 is rear view thereof;  
FIG. 42 is a front view thereof;  
FIG. 43 is a left side view thereof, a right side view thereof being a mirror image;  
FIG. 44 is a sectional left side view thereof, taken through a plane of FIG. 39 that bisects the right and left halves of the tea piece, a sectional right side view thereof being a mirror image;  
FIG. 45 is a sectional front view thereof, taken through a plane of FIG. 39 that bisects the front and back halves of the tea piece;  
FIG. 46 is a top perspective view of a sixth embodiment of the tea piece;  
FIG. 47 is a bottom perspective view thereof;  
FIG. 48 is a top view thereof;  
FIG. 49 is a bottom view thereof;  
FIG. 50 is rear view thereof;  
FIG. 51 is a front view thereof;  
FIG. 52 is a left side view thereof, a right side view thereof being a mirror image;  
FIG. 53 is a sectional left side view thereof, taken through a plane of FIG. 48 that bisects the right and left halves of the tea piece, a sectional right side view thereof being a mirror image;  
FIG. 54 is a sectional front view thereof, taken through a plane of FIG. 48 that bisects the front and back halves of the tea piece;  
FIG. 55 is a top perspective view of a seventh embodiment of the tea piece;

FIG. 56 is a bottom perspective view thereof;  
FIG. 57 is a top view thereof;  
FIG. 58 is a bottom view thereof;  
FIG. 59 is rear view thereof;  
FIG. 60 is a front view thereof;  
FIG. 61 is a left side view thereof, a right side view thereof being a mirror image;  
FIG. 62 is a sectional left side view thereof, taken through a plane of FIG. 57 that bisects the right and left halves of the tea piece, a sectional right side view thereof being a mirror image;  
FIG. 63 is a sectional front view thereof, taken through a plane of FIG. 57 that bisects the front and back halves of the tea piece;  
FIG. 64 is a top perspective view of a eighth embodiment of the tea piece;  
FIG. 65 is a bottom perspective view thereof;  
FIG. 66 is a top view thereof;  
FIG. 67 is a bottom view thereof;  
FIG. 68 is rear view thereof;  
FIG. 69 is a front view thereof;  
FIG. 70 is a left side view thereof, a right side view thereof being a mirror image;  
FIG. 71 is a sectional left side view thereof, taken through a plane of FIG. 66 that bisects the right and left halves of the tea piece, a sectional right side view thereof being a mirror image;  
FIG. 72 is a sectional front view thereof, taken through a plane of FIG. 66 that bisects the front and back halves of the tea piece;  
FIG. 73 is a top perspective view of a ninth embodiment of the tea piece;  
FIG. 74 is a bottom perspective view thereof;  
FIG. 75 is a top view thereof;  
FIG. 76 is a bottom view thereof;  
FIG. 77 is rear view thereof;  
FIG. 78 is a front view thereof;  
FIG. 79 is a left side view thereof, a right side view thereof being a mirror image;  
FIG. 80 is a sectional left side view thereof, taken through a plane of FIG. 75 bisects the right and left halves of the tea piece, a sectional right side view thereof being a mirror image;  
FIG. 81 is a sectional front view thereof, taken through a plane that bisects the front and back halves of the tea piece;  
FIG. 82 is a top perspective view of a tenth embodiment of the tea piece;  
FIG. 83 is a bottom perspective view thereof;  
FIG. 84 is a top view thereof;  
FIG. 85 is a bottom view thereof;  
FIG. 86 is rear view thereof;  
FIG. 87 is a front view thereof;  
FIG. 88 is a left side view thereof, a right side view thereof being a mirror image;  
FIG. 89 is a sectional left side view thereof, taken through a plane of FIG. 84 that bisects the right and left halves of the tea piece, a sectional right side view thereof being a mirror image;  
FIG. 90 is a sectional front view thereof, taken through a plane of FIG. 84 that bisects the front and back halves of the tea piece;  
FIG. 91 is a top perspective view of a eleventh embodiment of the tea piece;  
FIG. 92 is a bottom perspective view thereof;

FIG. 93 is a top view thereof;  
 FIG. 94 is a bottom view thereof;  
 FIG. 95 is rear view thereof;  
 FIG. 96 is a front view thereof;  
 FIG. 97 is a left side view thereof, a right side view thereof being a mirror image;  
 FIG. 98 is a sectional left side view thereof, taken through a plane of FIG. 93 that bisects the right and left halves of the tea piece, a sectional right side view thereof being a mirror image;  
 FIG. 99 is a sectional front view thereof, taken through a plane of FIG. 93 that bisects the front and back halves of the tea piece;  
 FIG. 100 is a top perspective view of a twelfth embodiment of the tea piece;  
 FIG. 101 is a bottom perspective view thereof;  
 FIG. 102 is a top view thereof;  
 FIG. 103 is a bottom view thereof;  
 FIG. 104 is rear view thereof;  
 FIG. 105 is a front view thereof;  
 FIG. 106 is a left side view thereof, a right side view thereof being a mirror image;  
 FIG. 107 is a sectional left side view thereof, taken through a plane of FIG. 102 that bisects the right and left halves of the tea piece, a sectional right side view thereof being a mirror image; and,  
 FIG. 108 is a sectional front view thereof, taken through a plane of FIG. 102 that bisects the front and back halves of the tea piece.  
 Where included, three adjacent parallel broken lines on a surface are used to show transparency of the tea piece.

**1 Claim, 24 Drawing Sheets**

(58) **Field of Classification Search**

CPC ..... A47G 19/12; A47J 27/00; A47J 27/002;  
 A47J 27/08; A47J 27/21; A47J 27/58;

A47J 36/025; A47J 36/06; A47J 36/12;  
 A47J 37/00; A47J 37/10; A47J 37/101;  
 A47J 37/103; A47J 37/12; A47J 37/1204;  
 A47J 45/061; A47J 45/071; A47J 45/08;  
 H05B 6/12

See application file for complete search history.

(56)

**References Cited**

U.S. PATENT DOCUMENTS

D608,147	S	*	2/2010	Sykes	.....	D7/507
D652,254	S	*	1/2012	Dancsecs	.....	D7/510
D664,001	S	*	7/2012	Liu	.....	D7/510
D723,871	S	*	3/2015	Khubani et al.	.....	D7/505
D763,621	S	*	8/2016	Szymanski	.....	D7/507
D807,702	S	*	1/2018	Szymanski	.....	D7/510
2010/0270284	A1		10/2010	Cohen et al.		

FOREIGN PATENT DOCUMENTS

GB	2261594	5/1993
GB	2504348	1/2014
JP	8-100972	4/1996
JP	3038293	6/1997
JP	2003-339545	A 12/2003

OTHER PUBLICATIONS

International Search Report issued in corresponding International Patent Application No. PCT/IB2015/055147 dated Feb. 10, 2016 (7 pages).  
 International Preliminary Report on Patentability issued in corresponding International Patent Application No. PCT/IB2015/055147 dated Nov. 2, 2016 (34 pages).  
 Non-final Office Action U.S. Appl. No. 15/324,484 dated May 23, 2018.  
 Non-final Office Action U.S. Appl. No. 29/551,489 dated Mar. 28, 2018.

\* cited by examiner



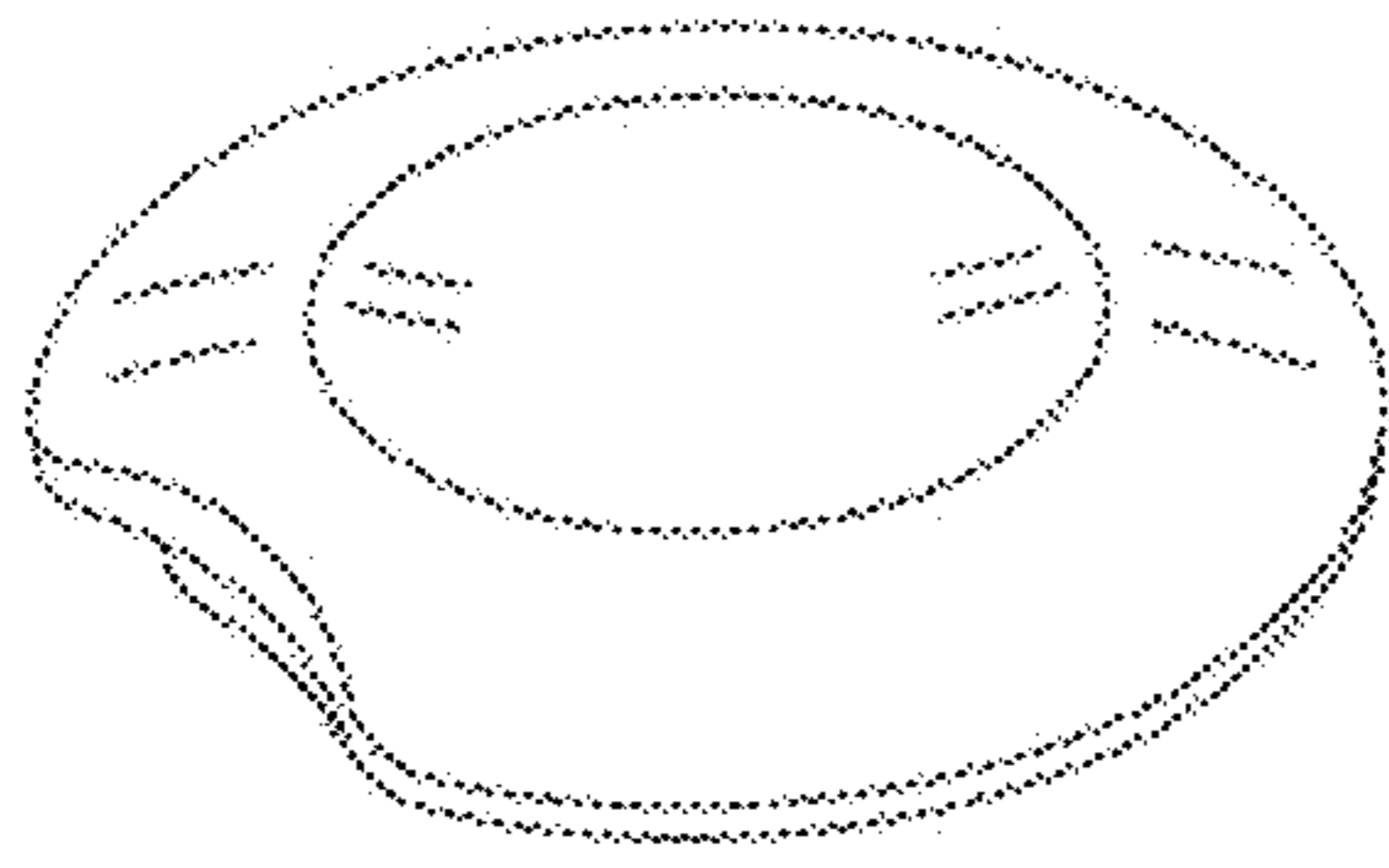

Fig. 1

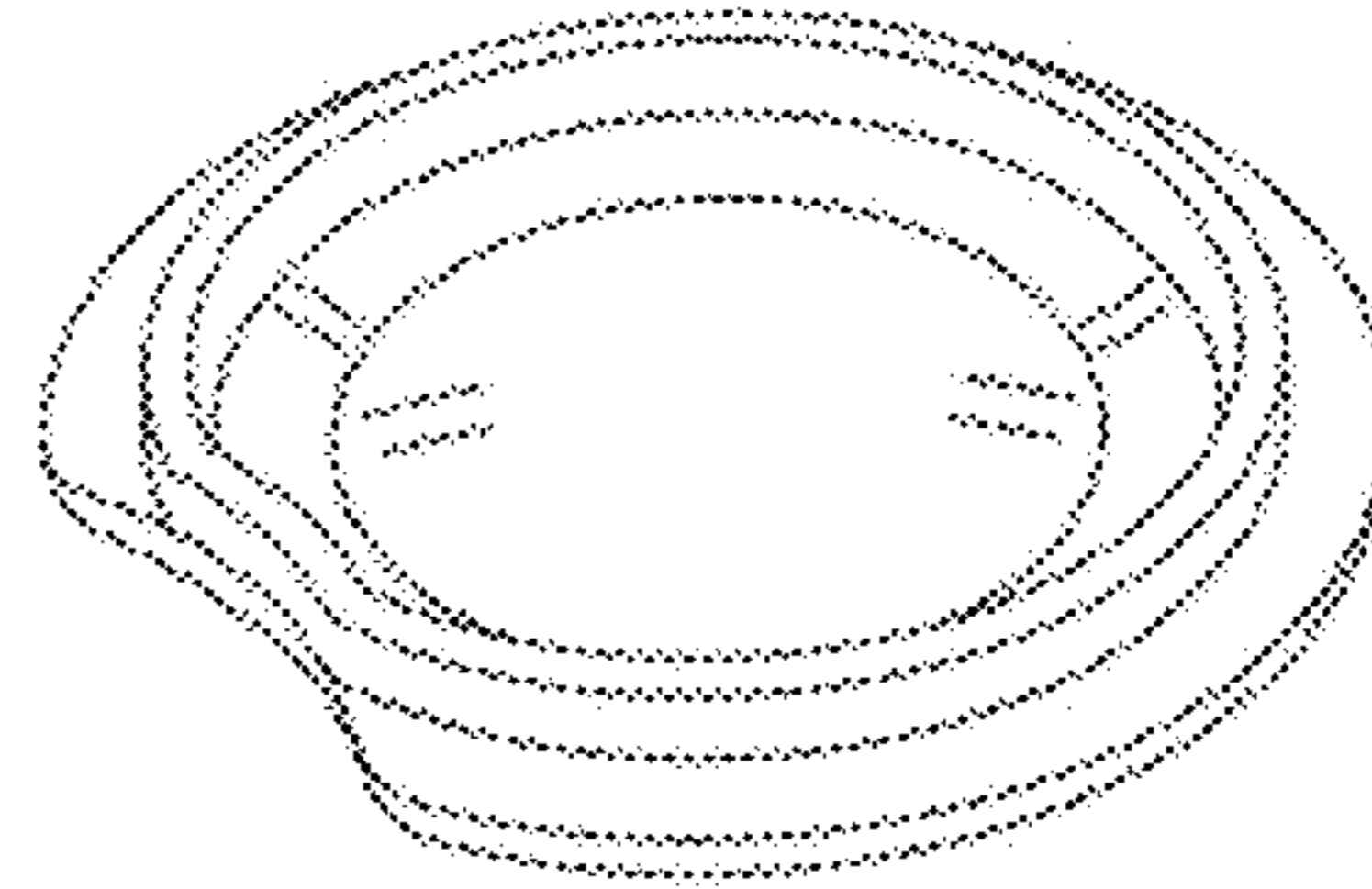

Fig. 2

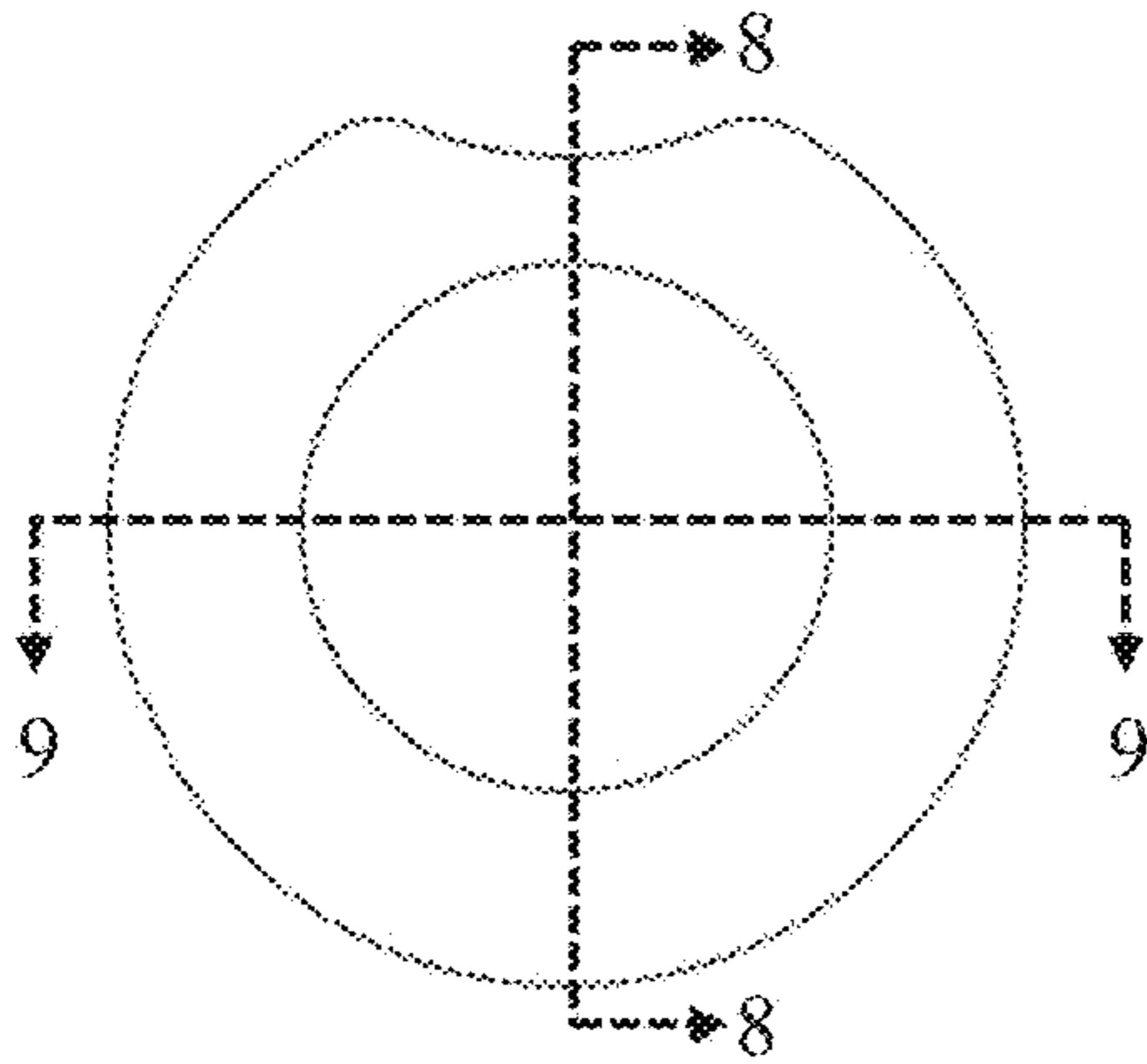

Fig. 3

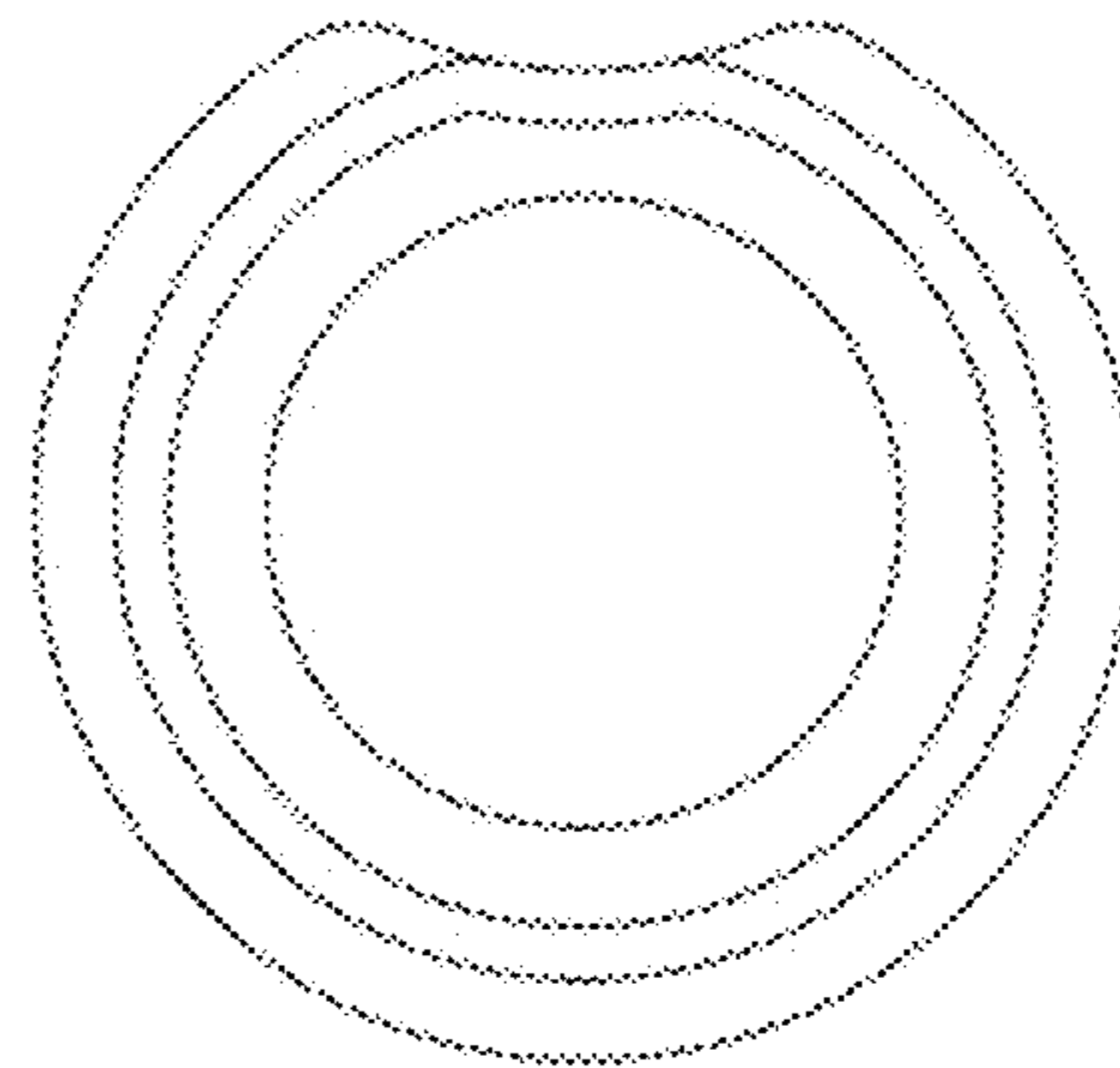

Fig. 4

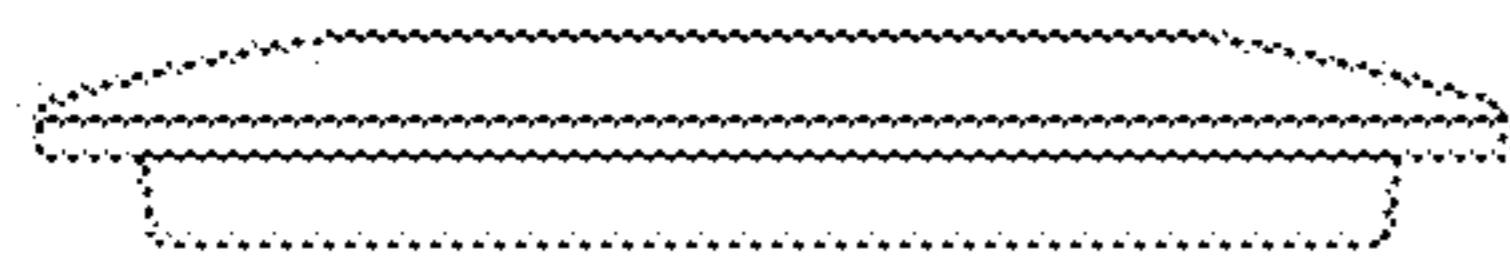

Fig. 5

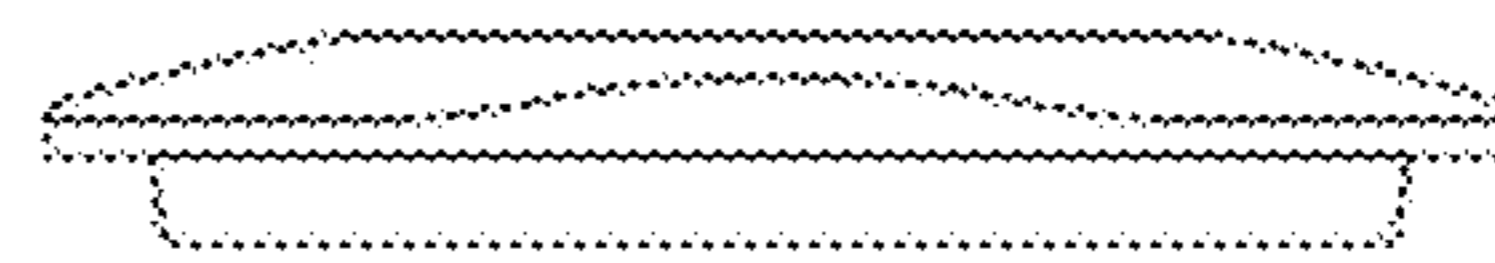

Fig. 6

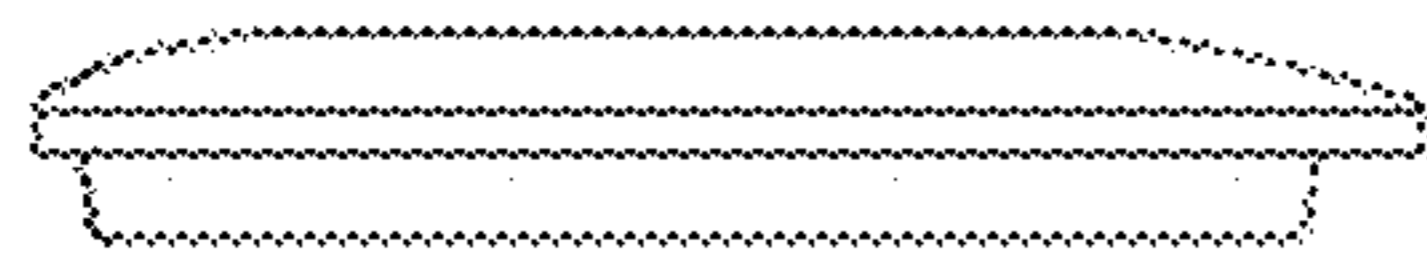

Fig. 7

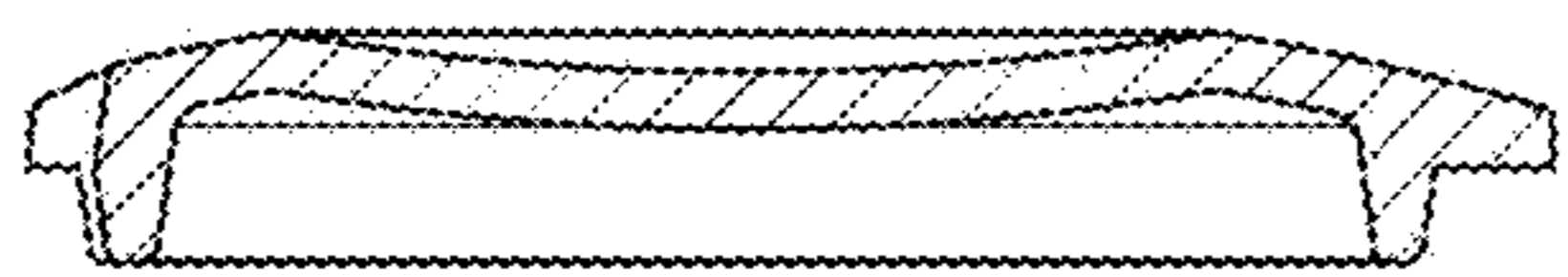

Fig. 8

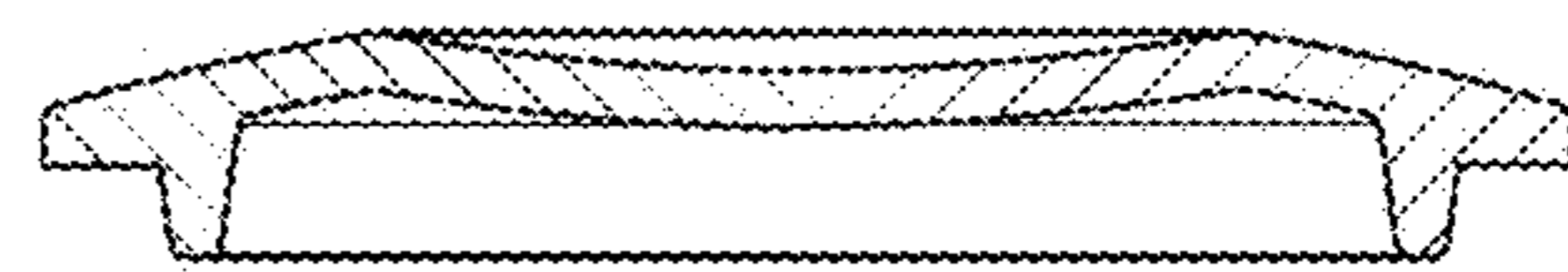

Fig. 9

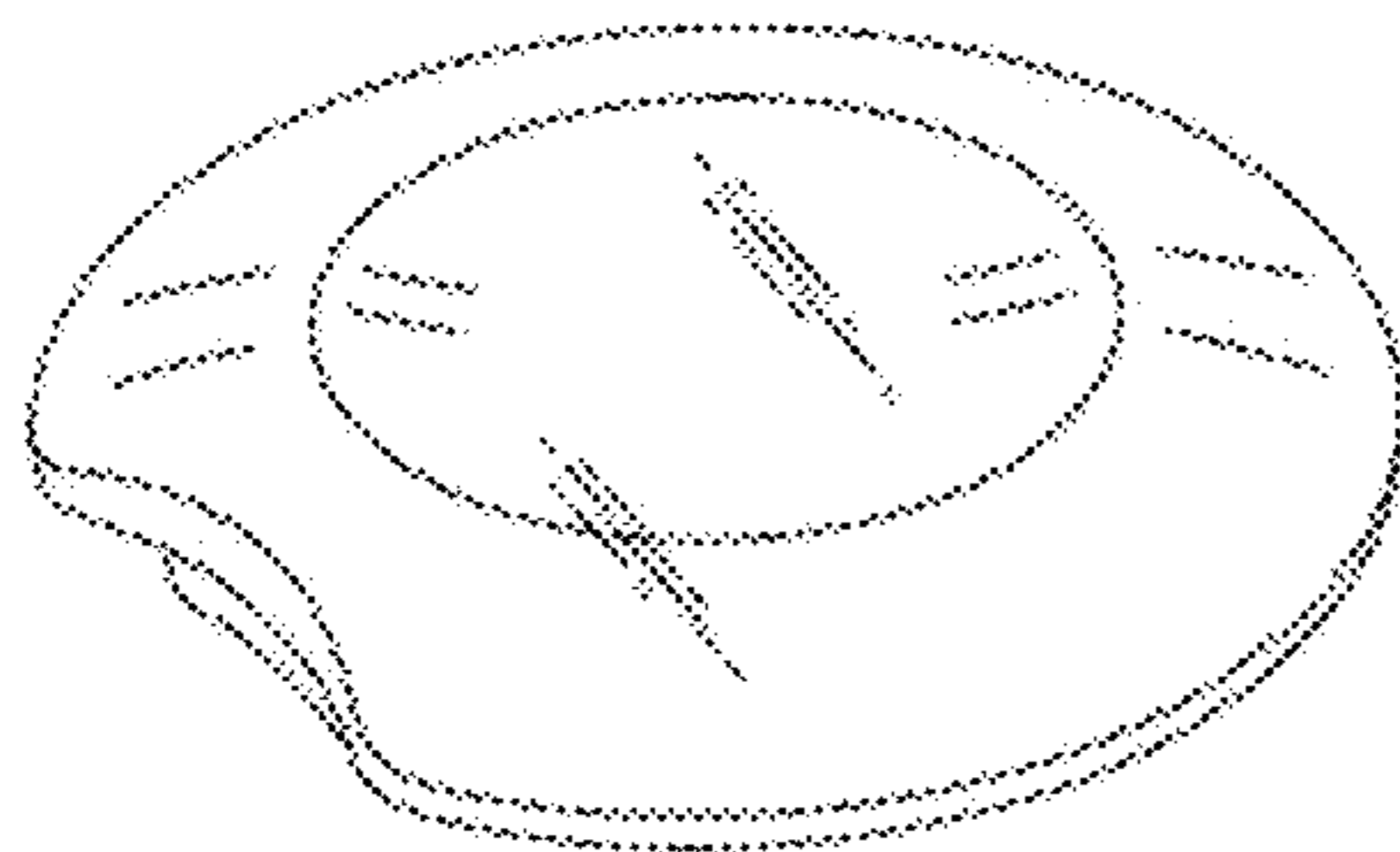

Fig. 10

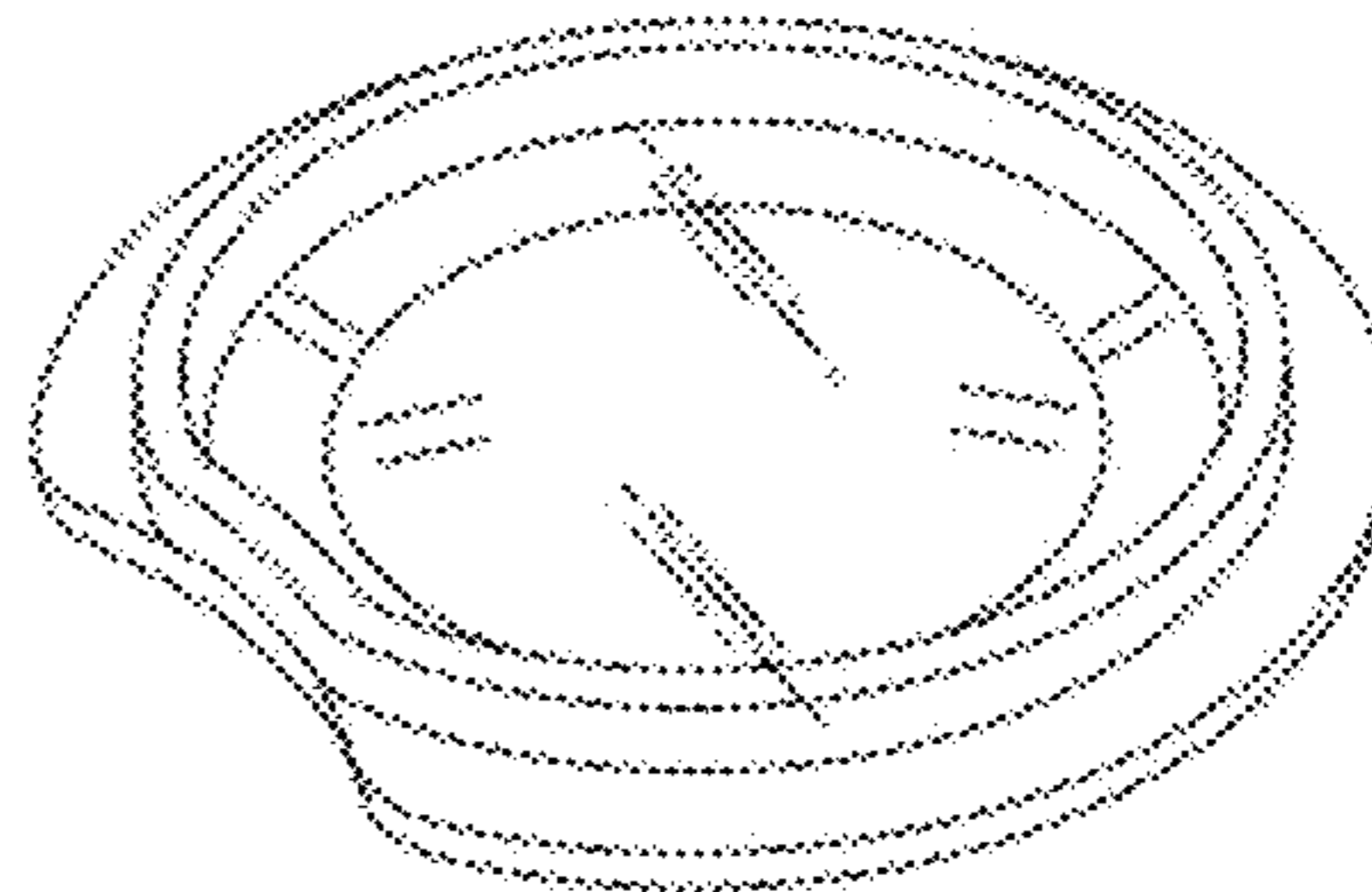

Fig. 11

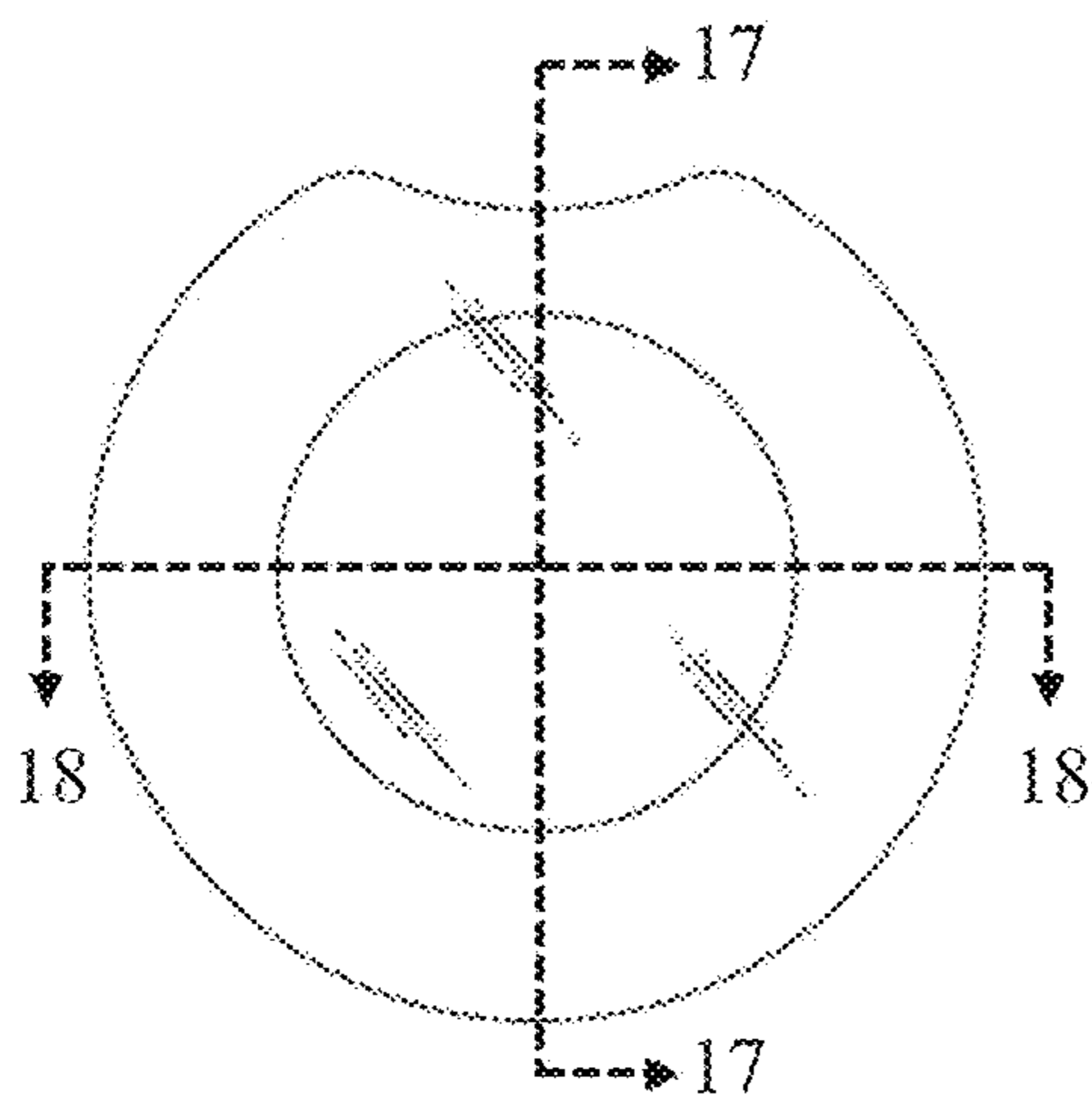

Fig. 12

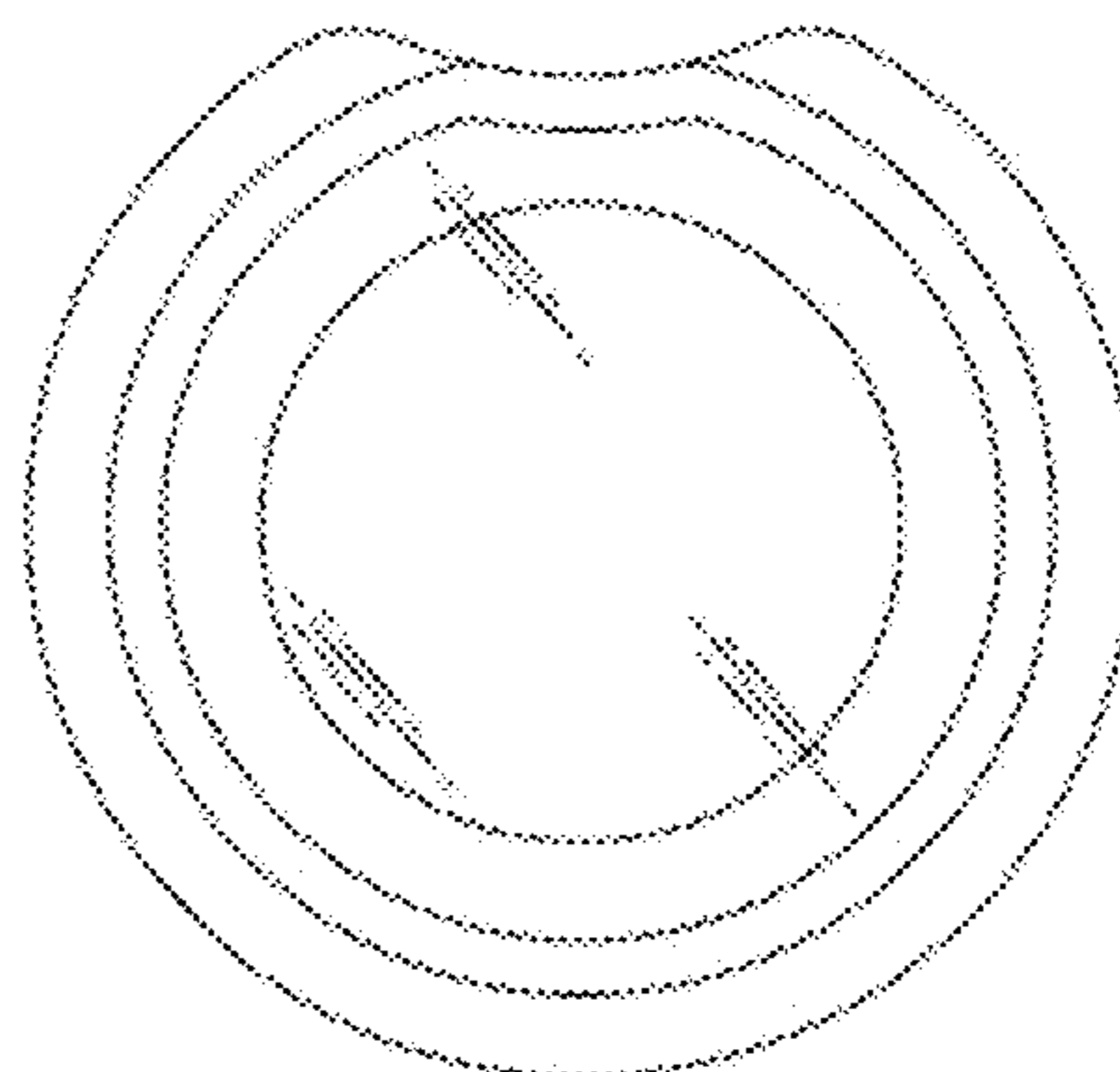

Fig. 13

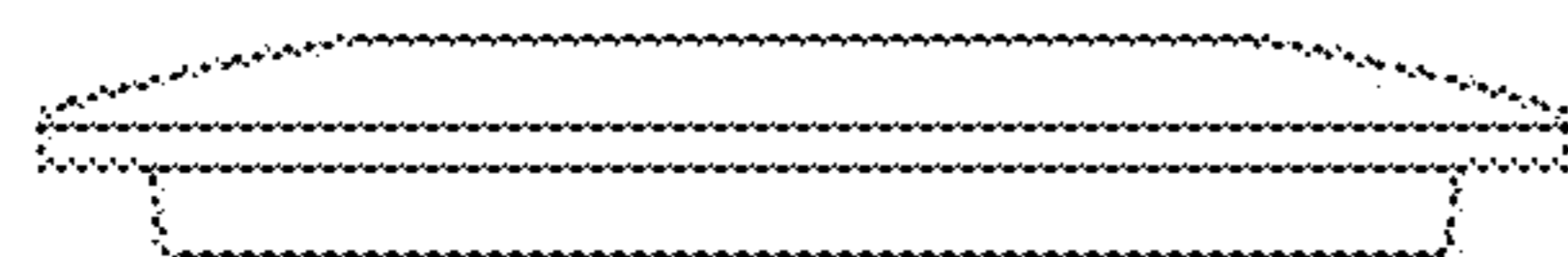

Fig. 14

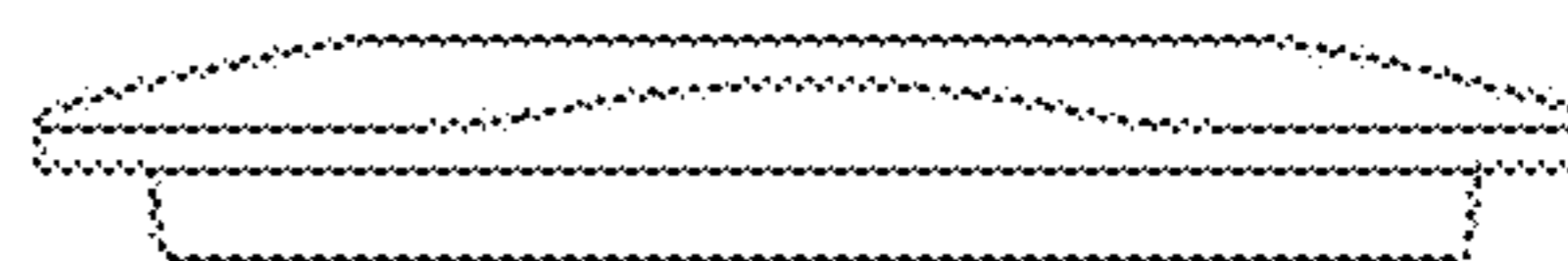

Fig. 15

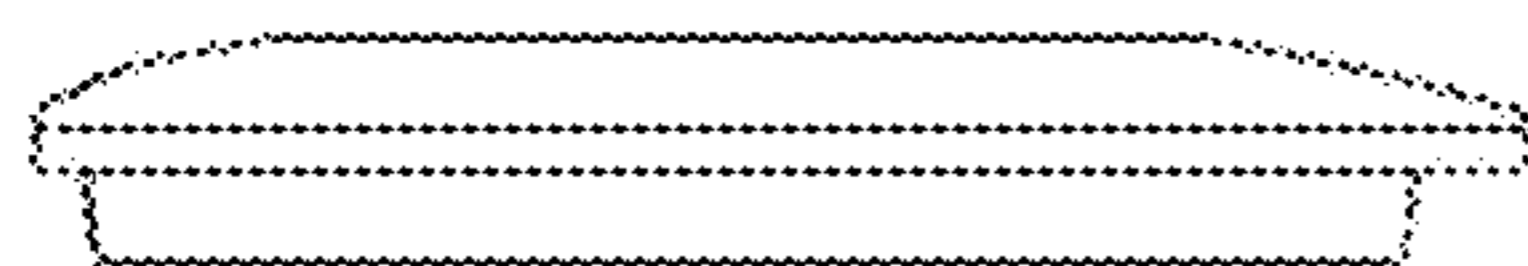

Fig. 16

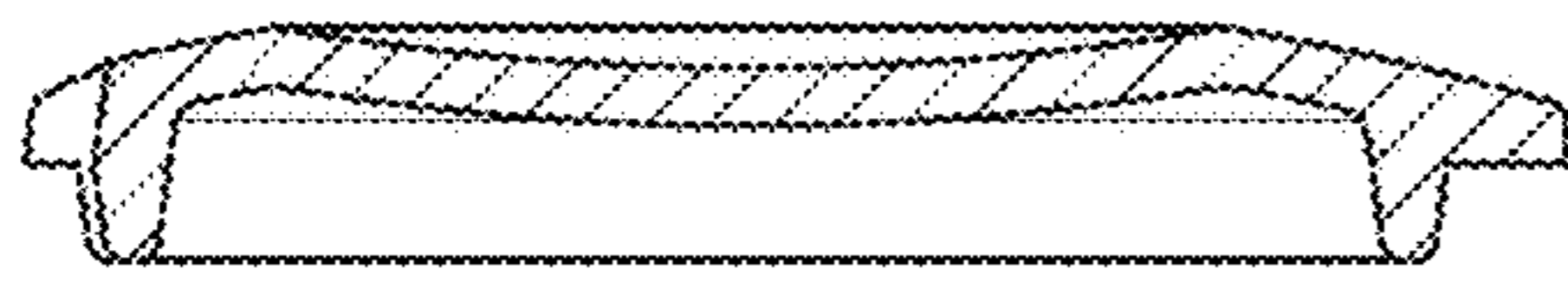

Fig. 17

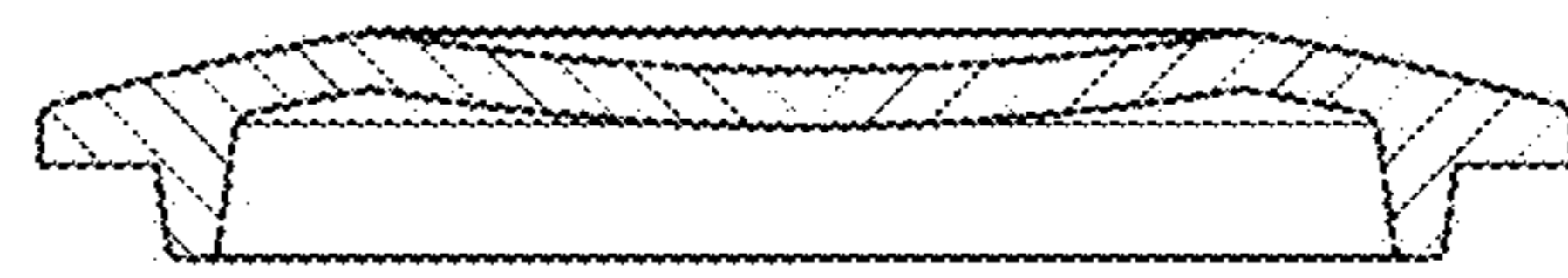

Fig. 18

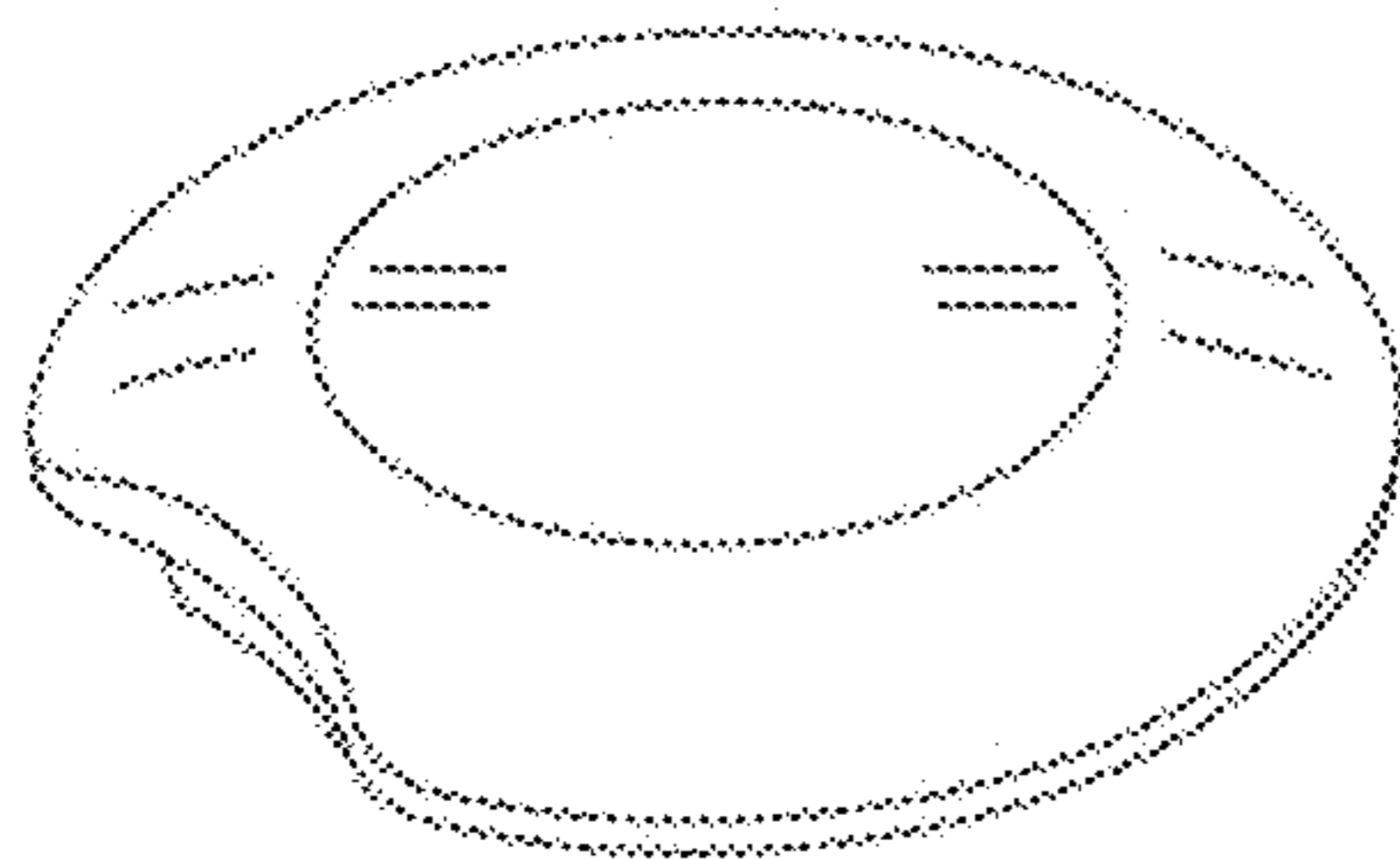

Fig. 19

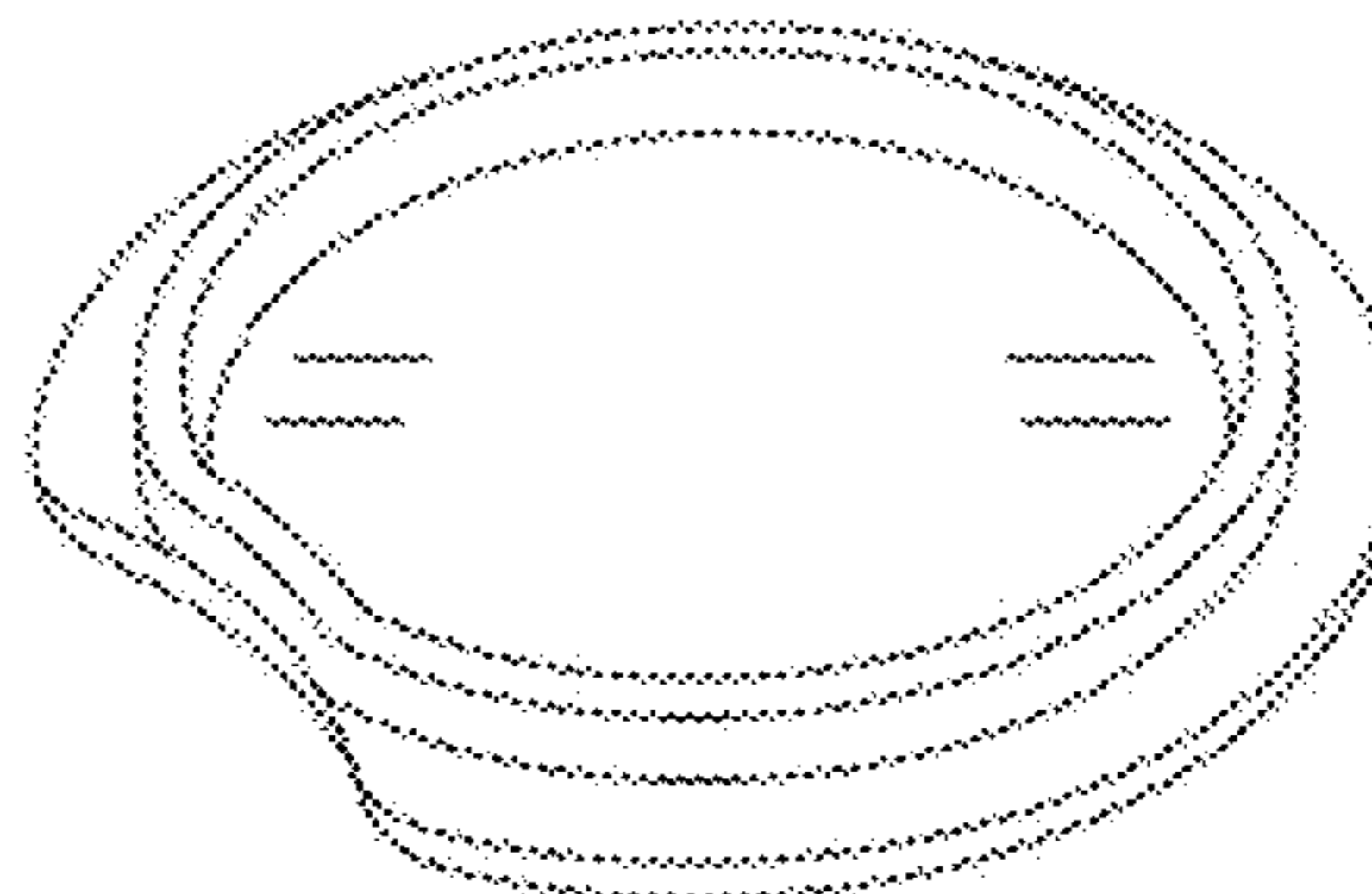

Fig. 20

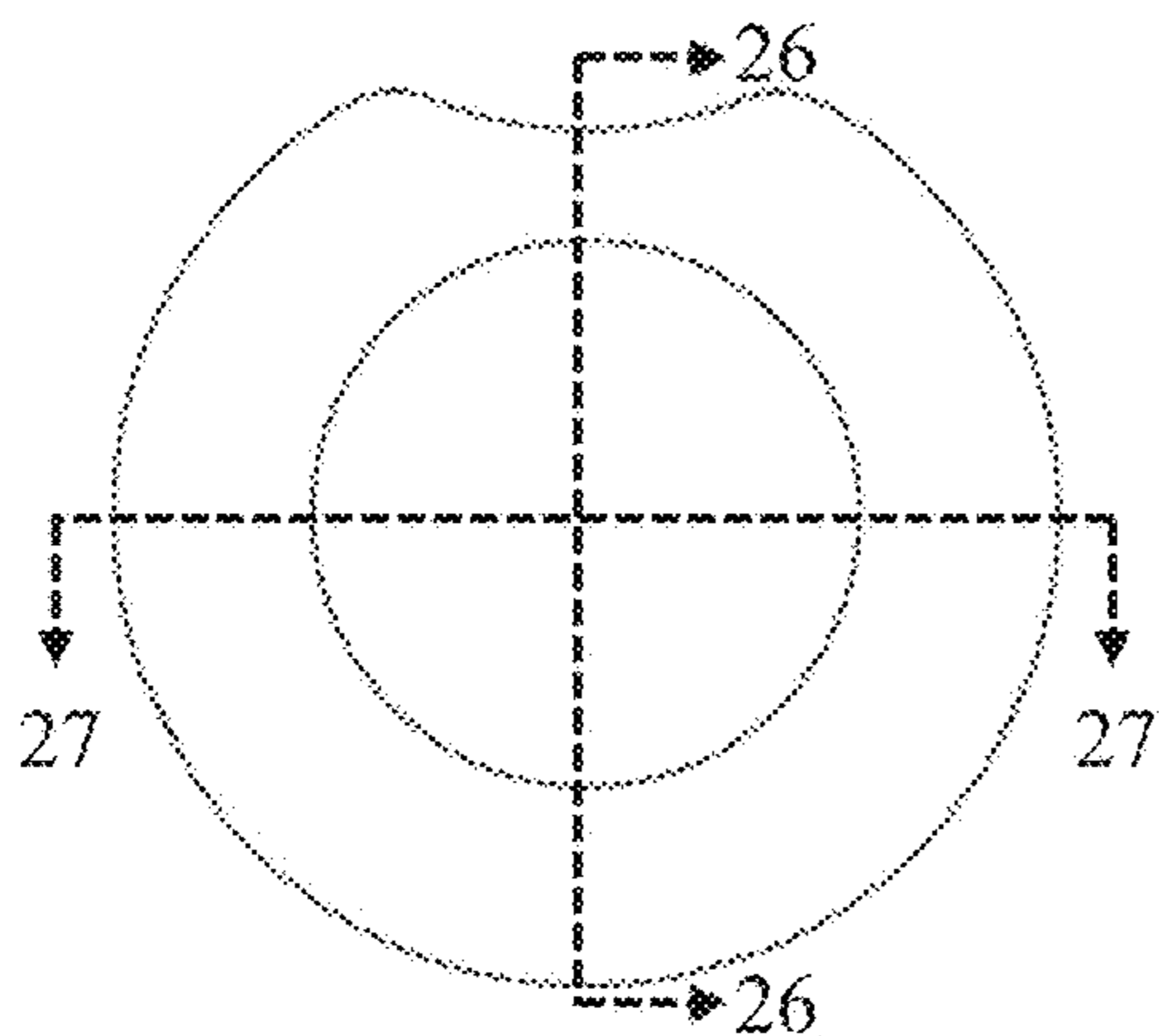

Fig. 21

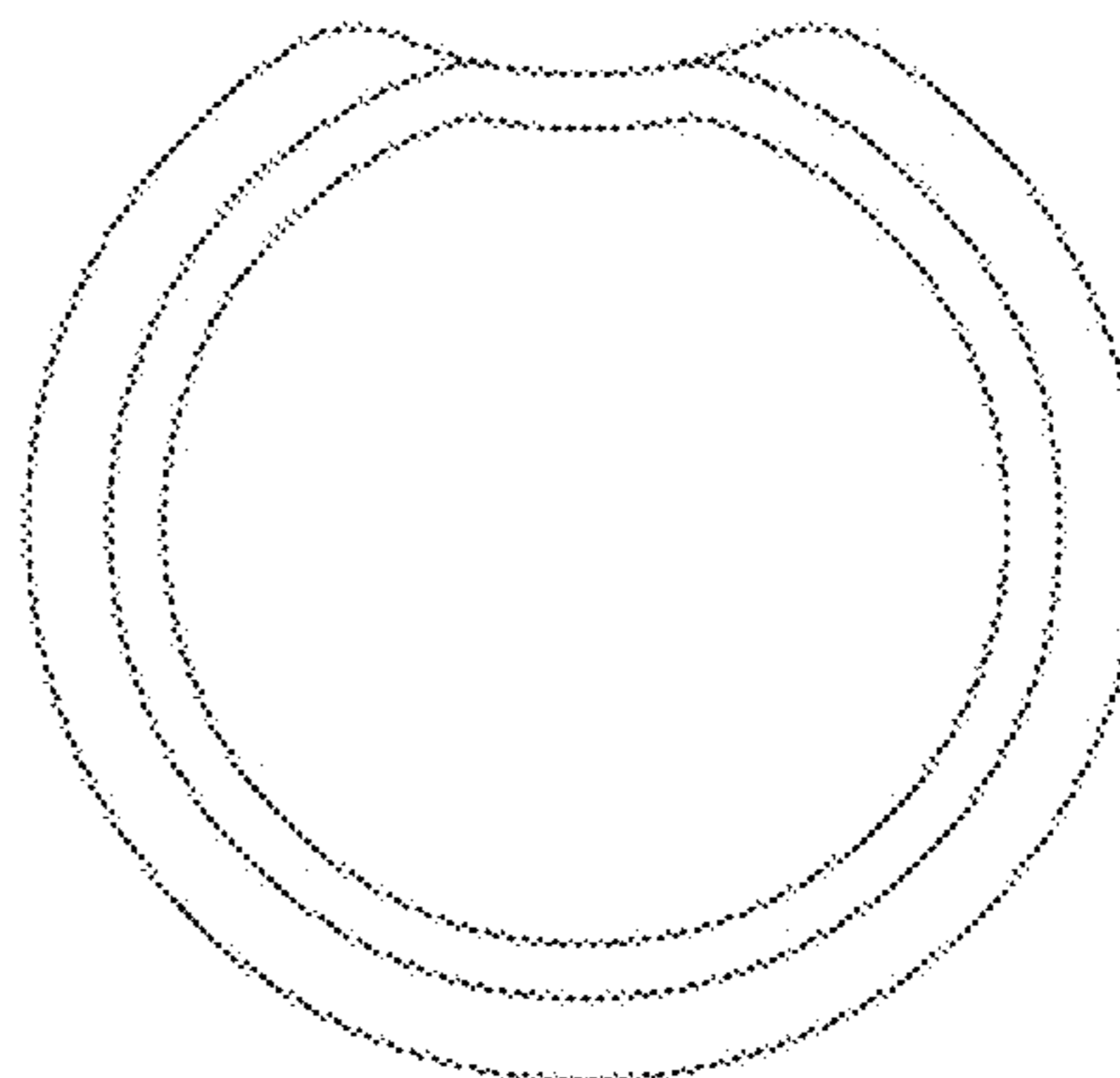

Fig. 22



Fig. 23

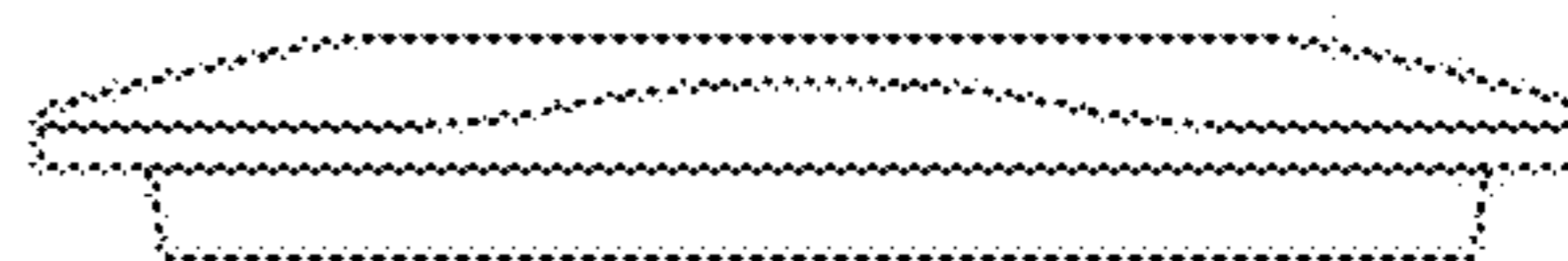

Fig. 24

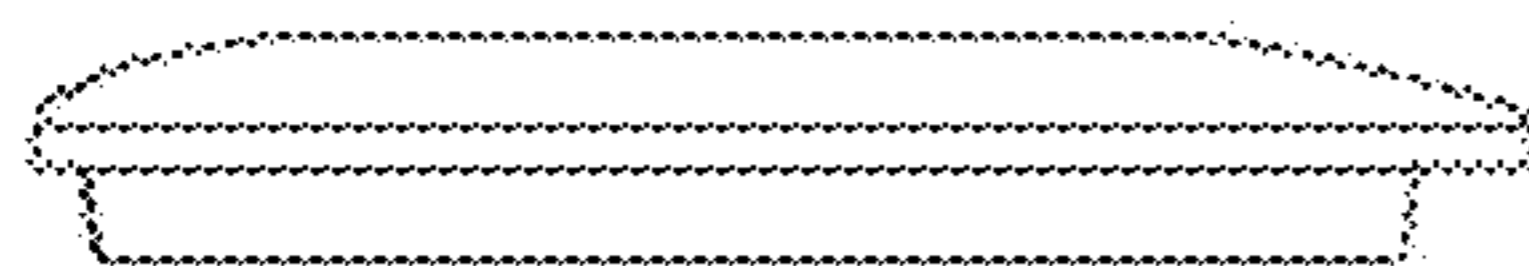

Fig. 25



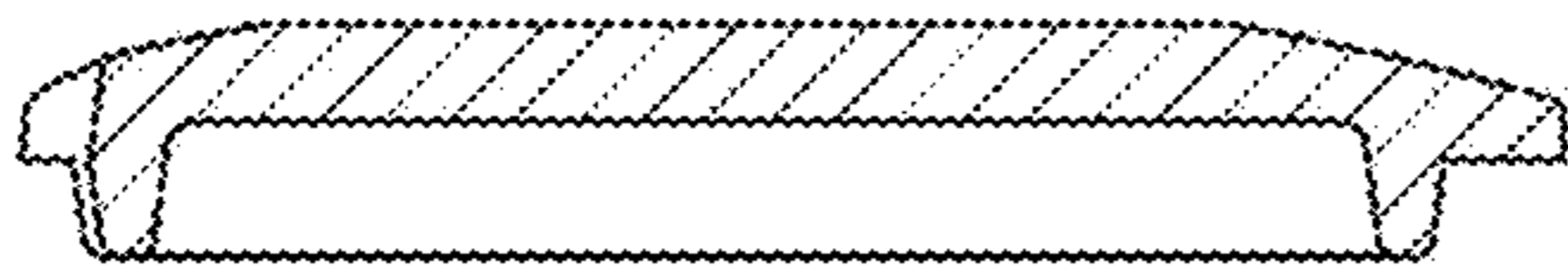

Fig. 26



Fig. 27

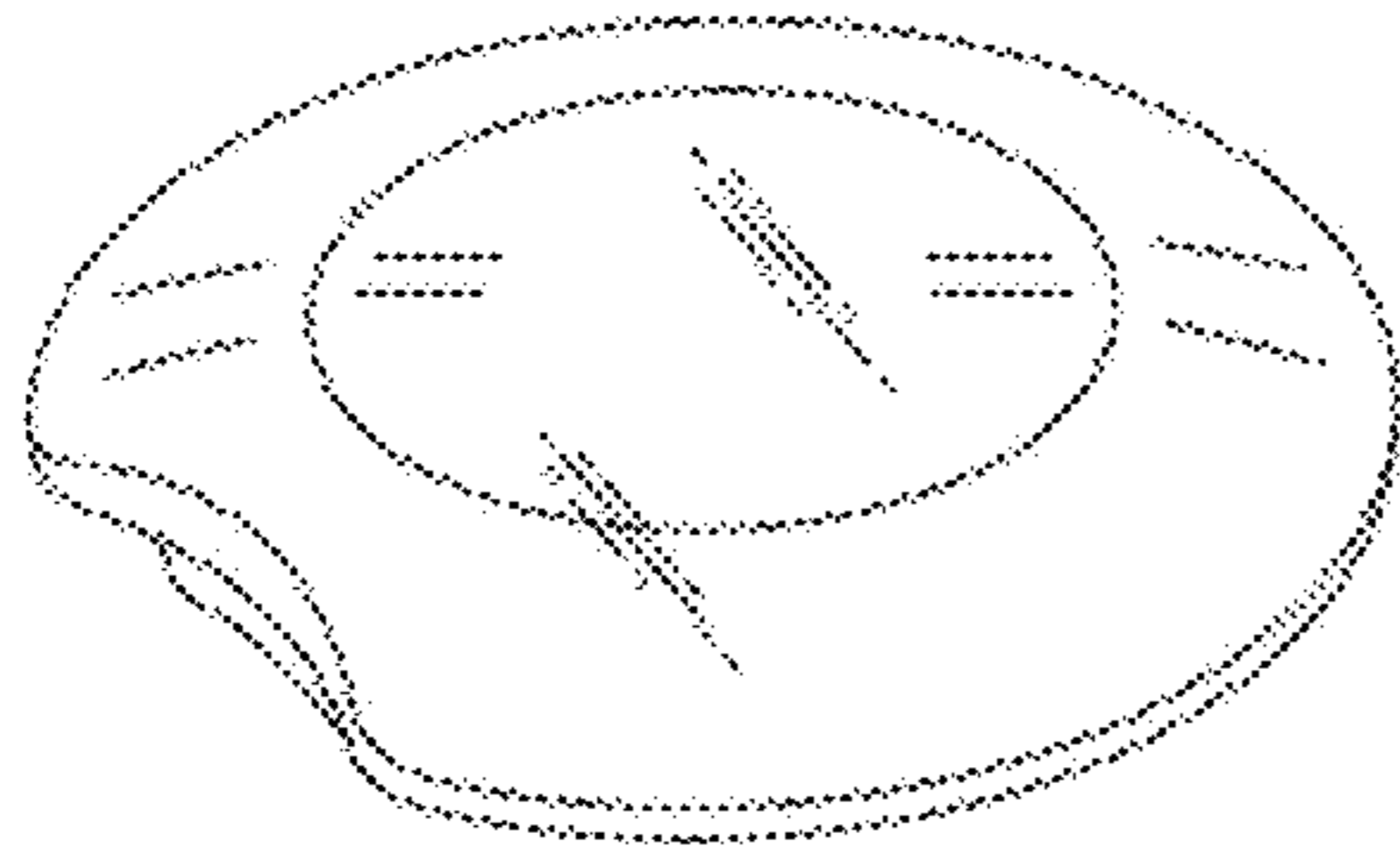

Fig. 28

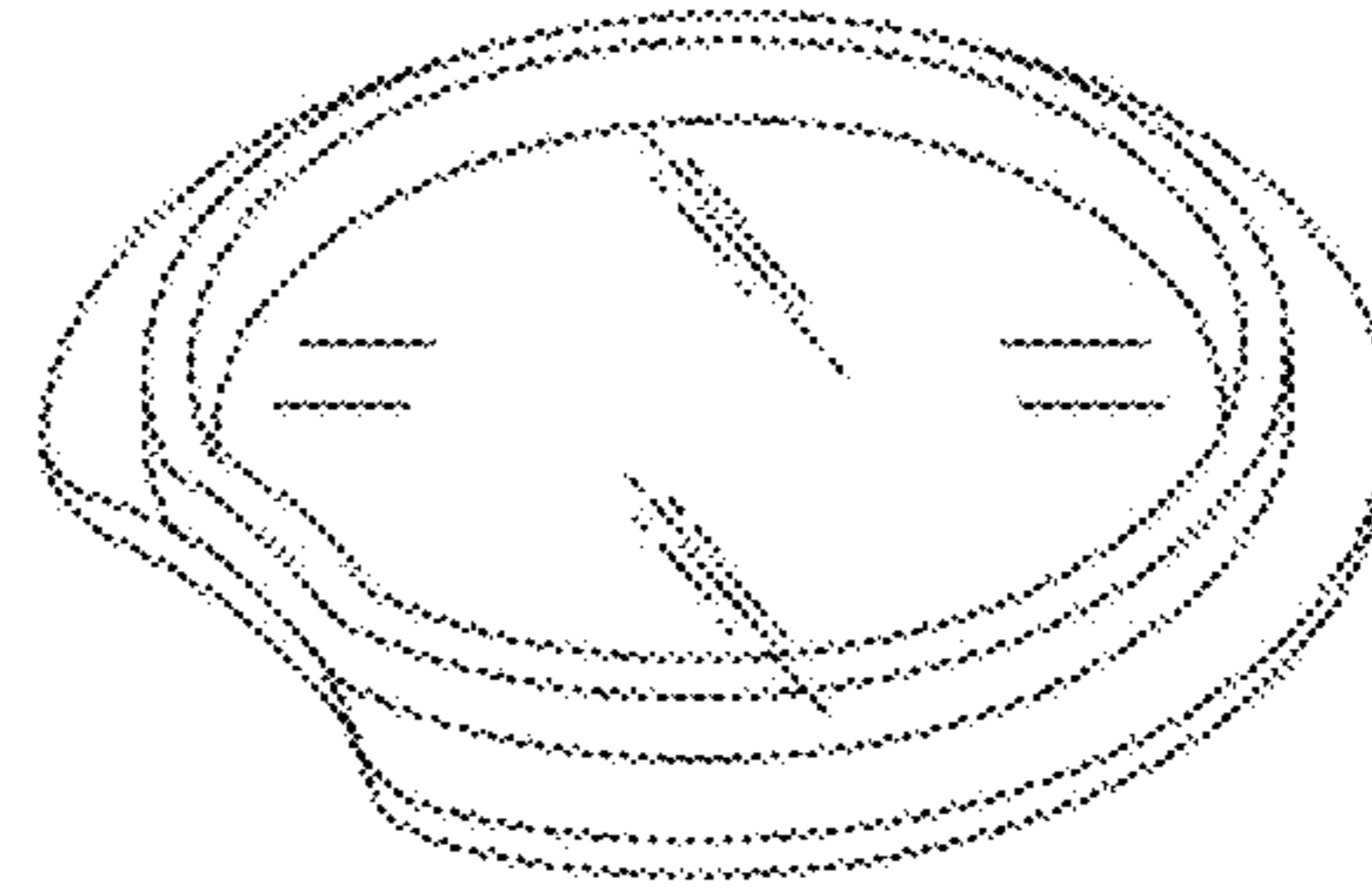

Fig. 29

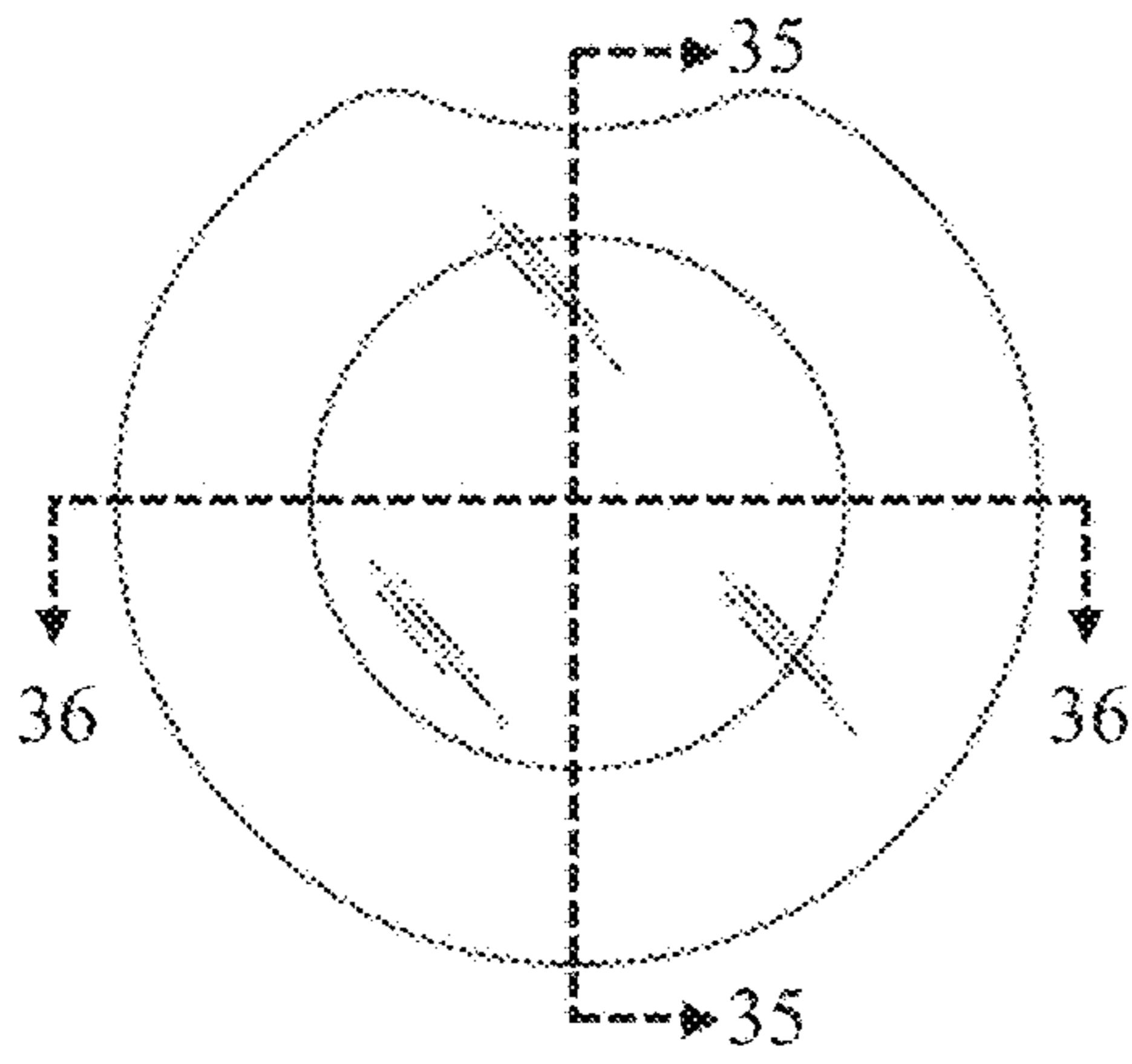

Fig. 30

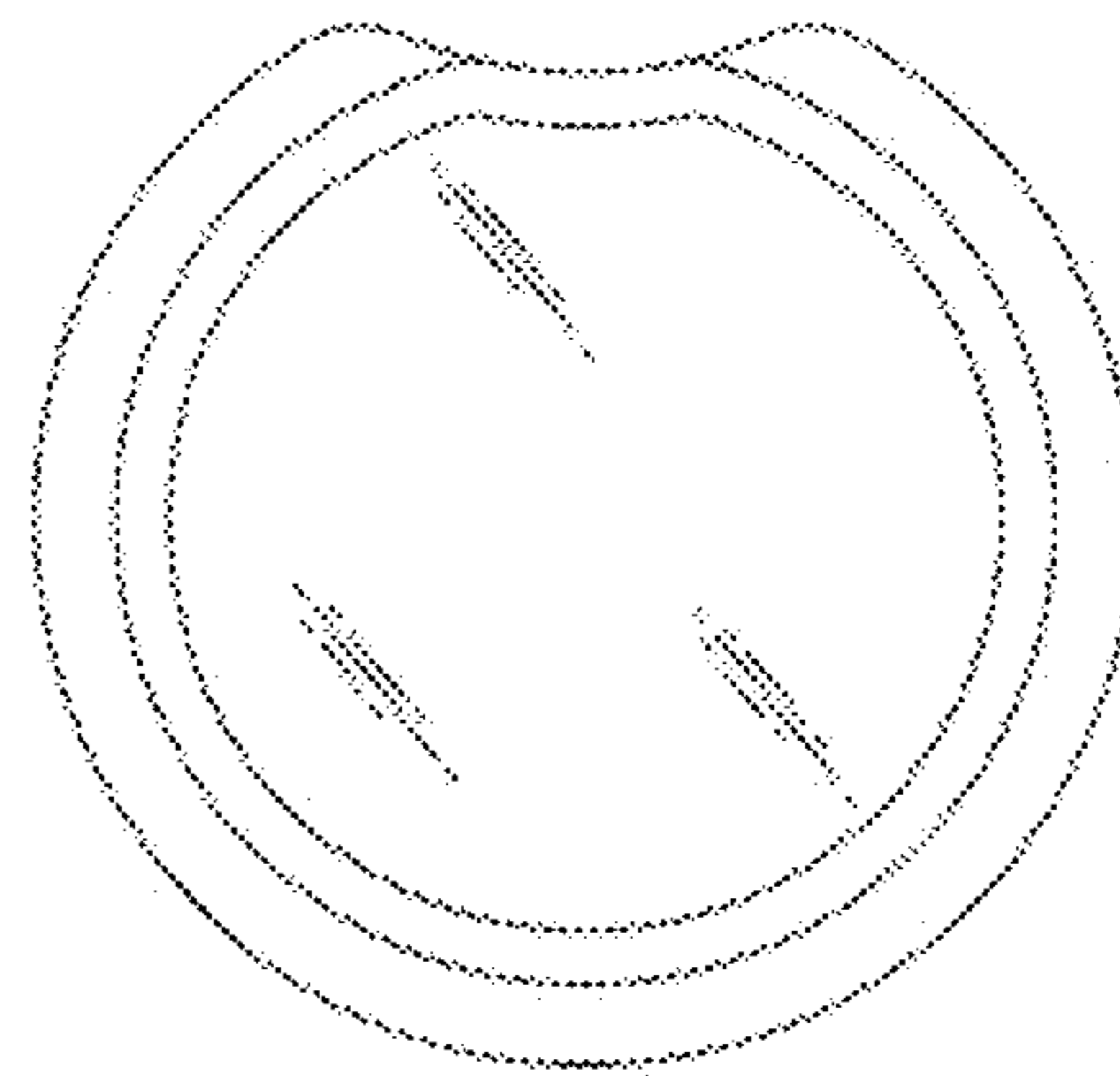

Fig. 31

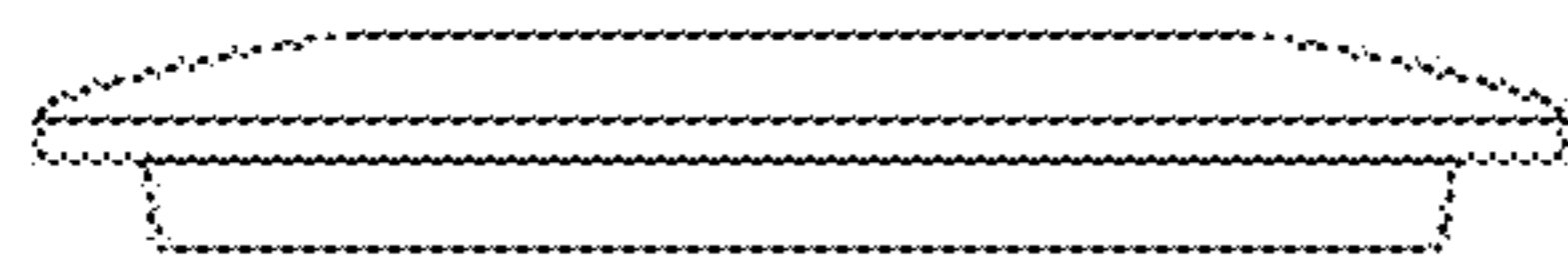

Fig. 32

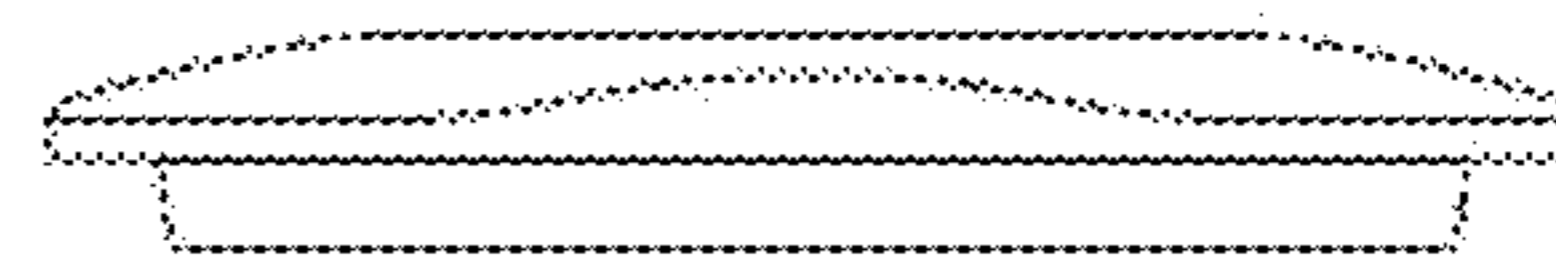

Fig. 33

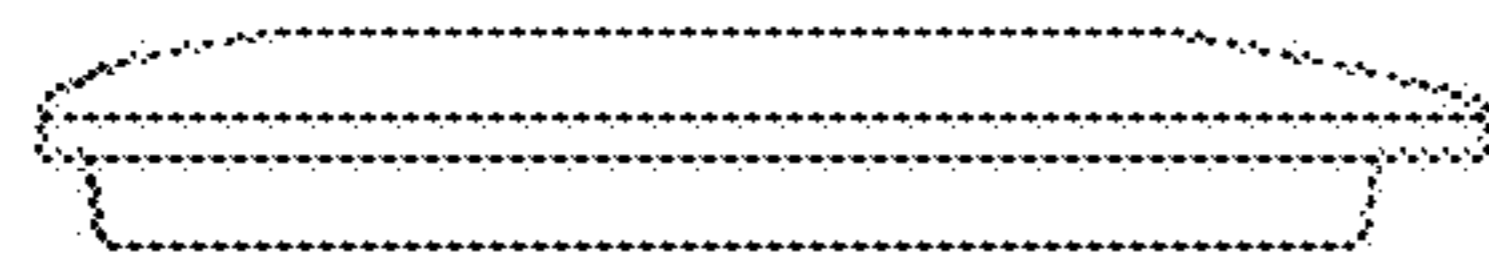
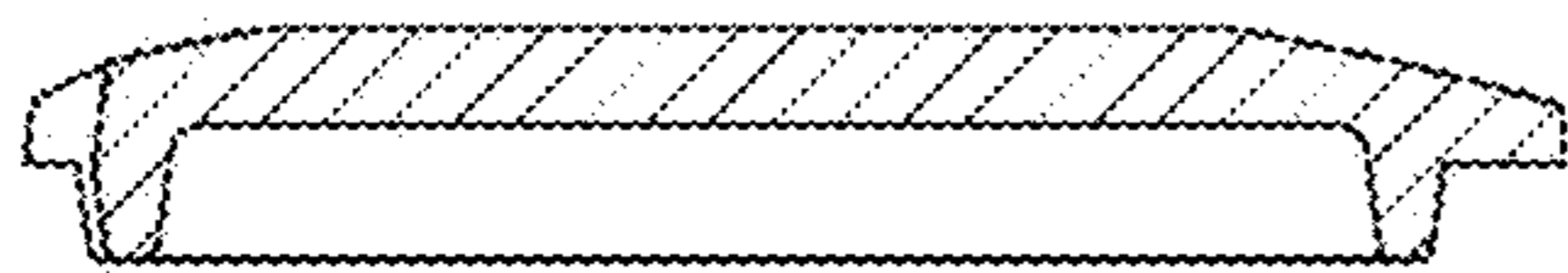

Fig. 34



*Fig. 35*



*Fig. 36*

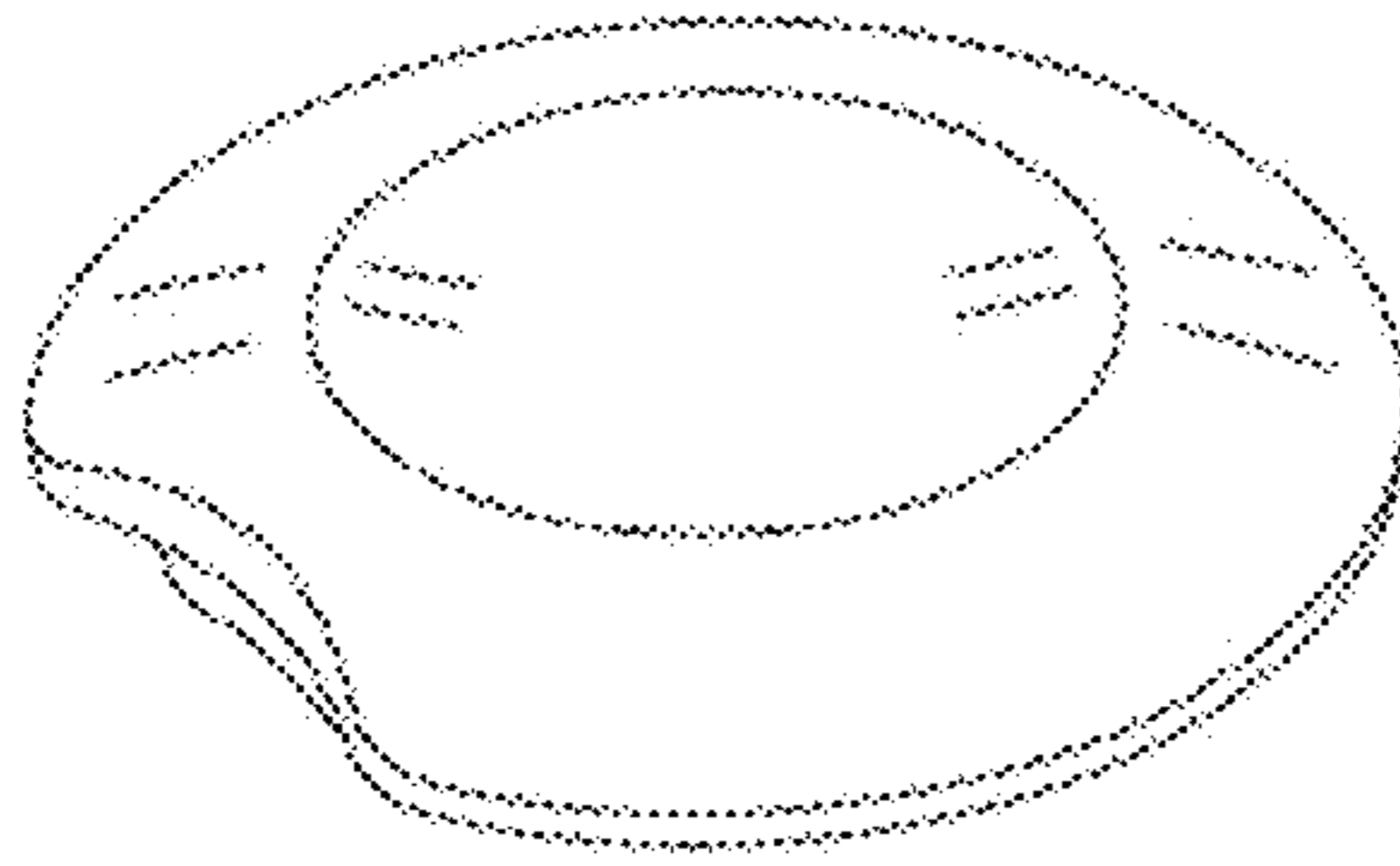

Fig. 37

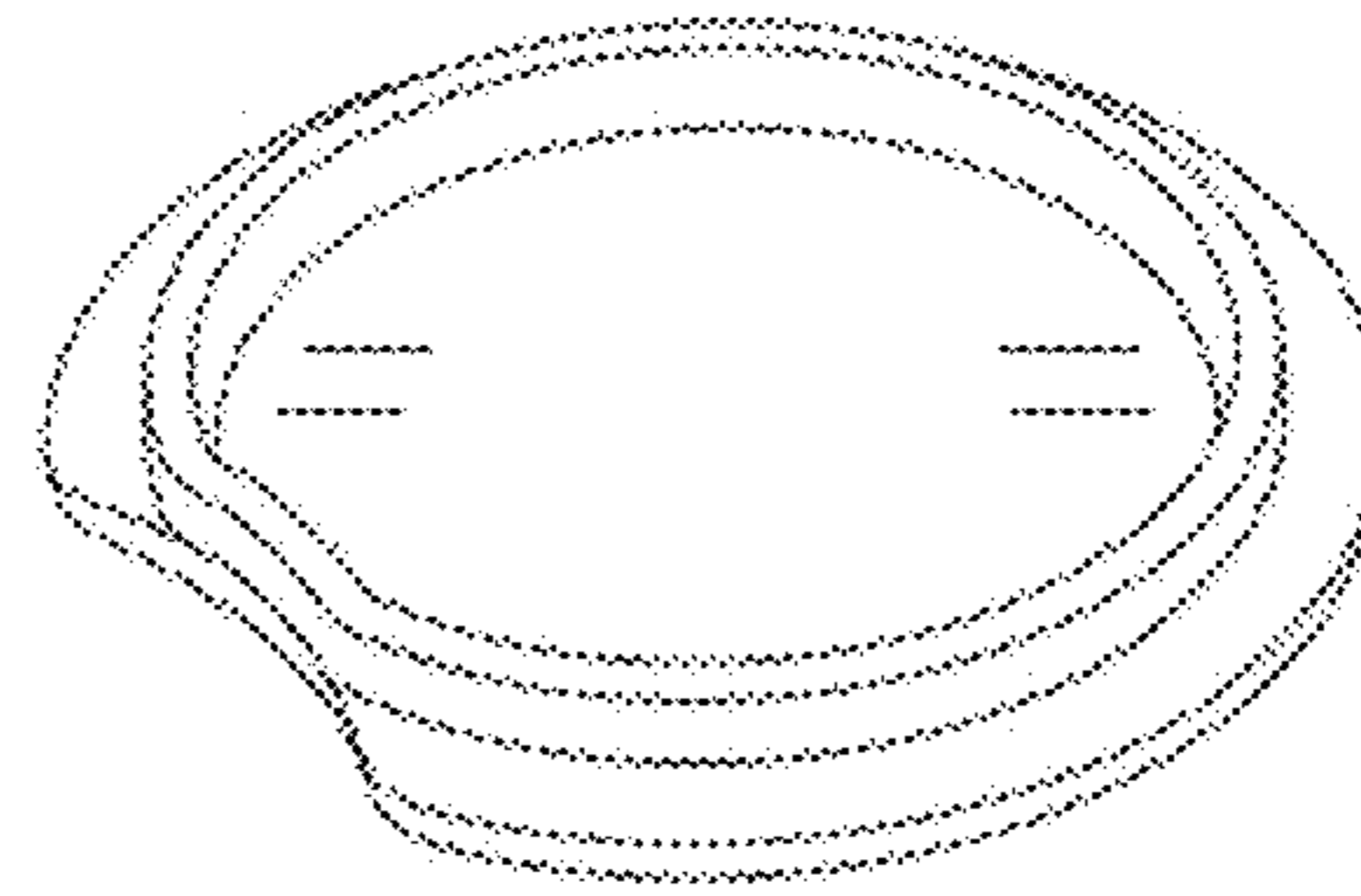

Fig. 38

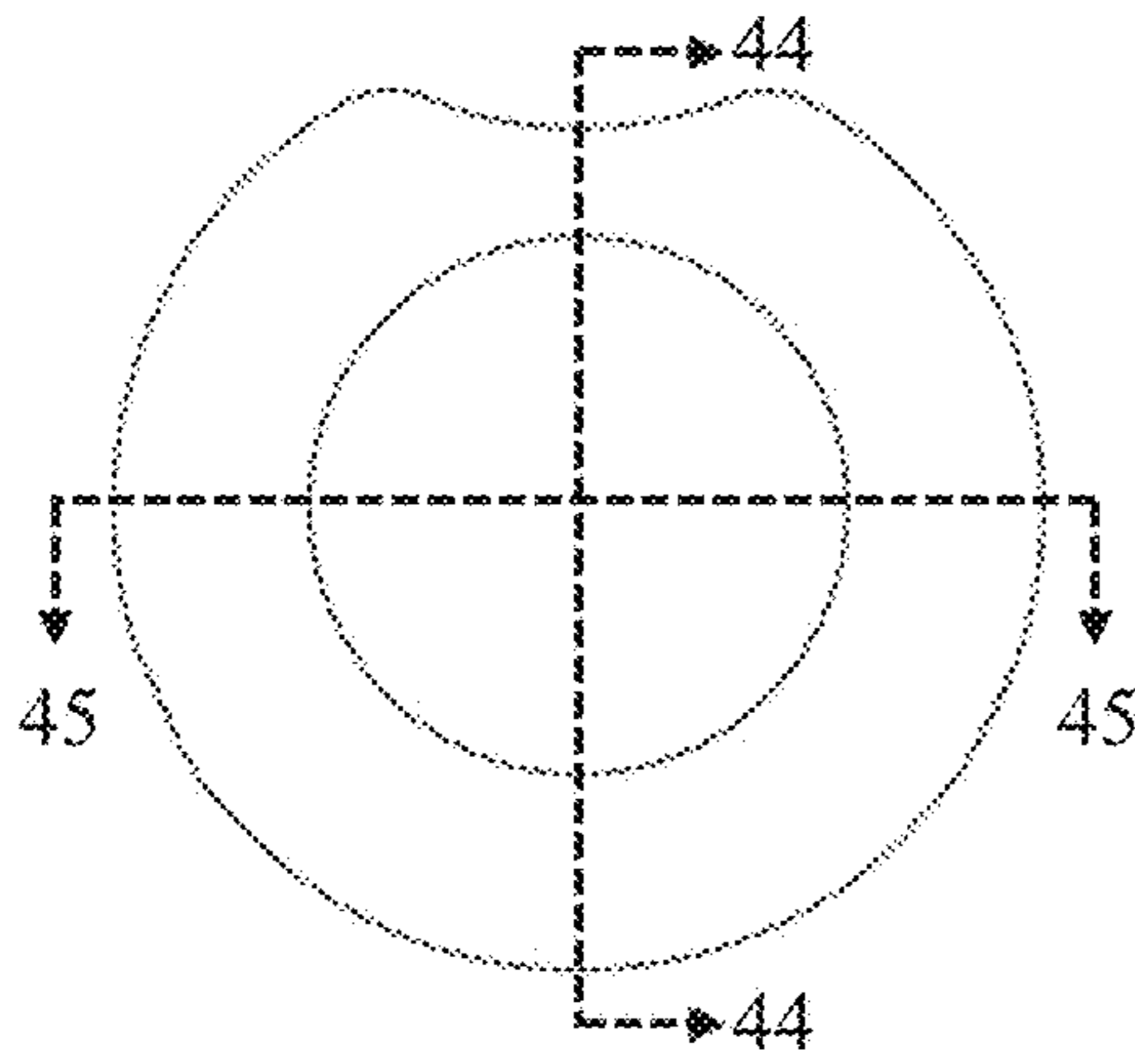

Fig. 39

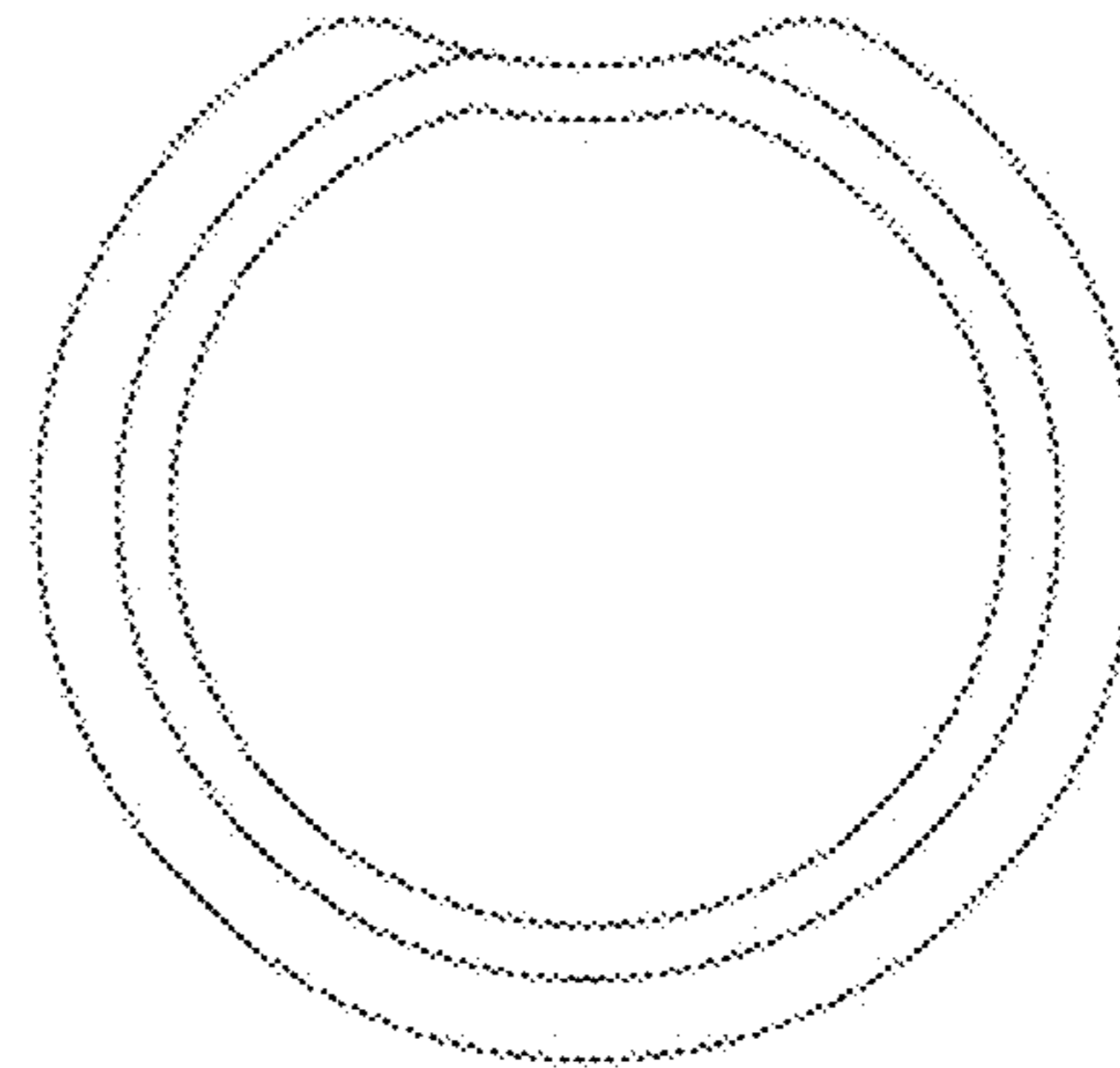

Fig. 40

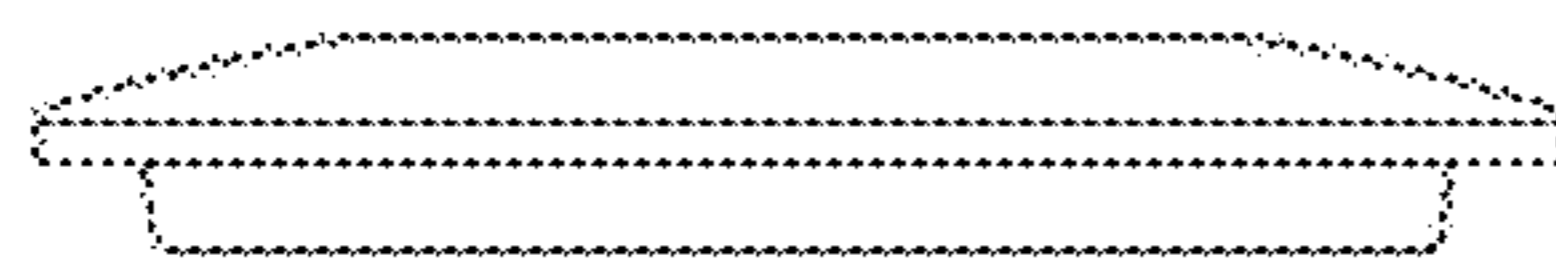

Fig. 41

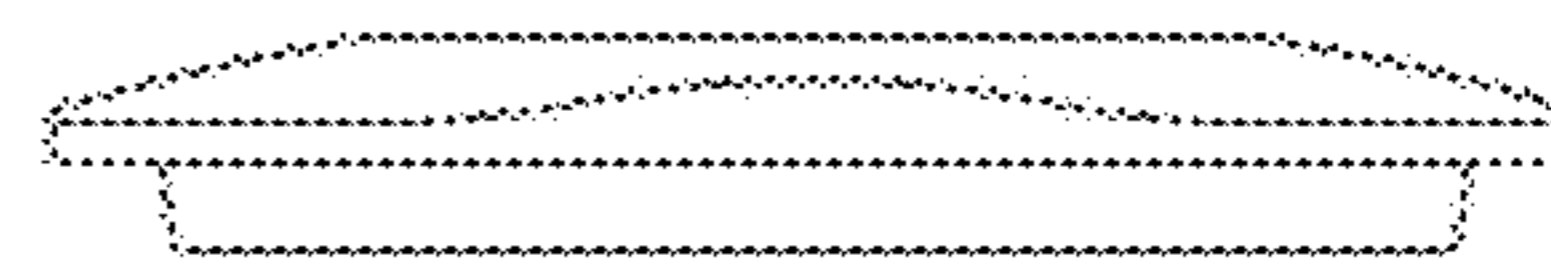

Fig. 42

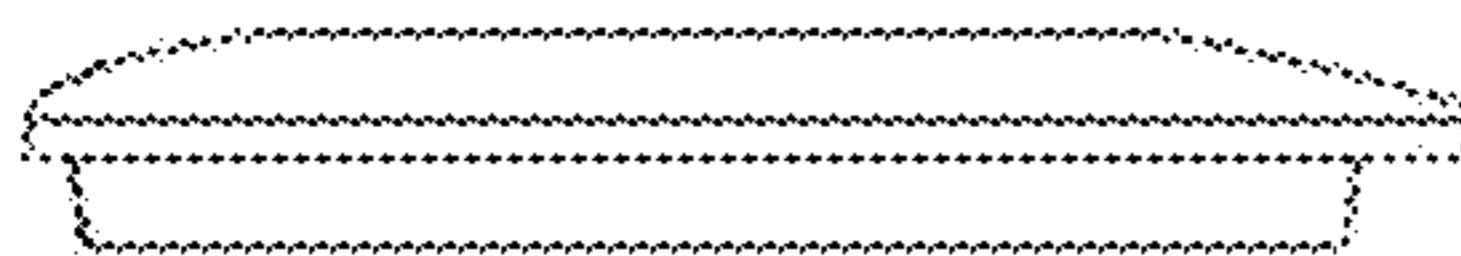

Fig. 43



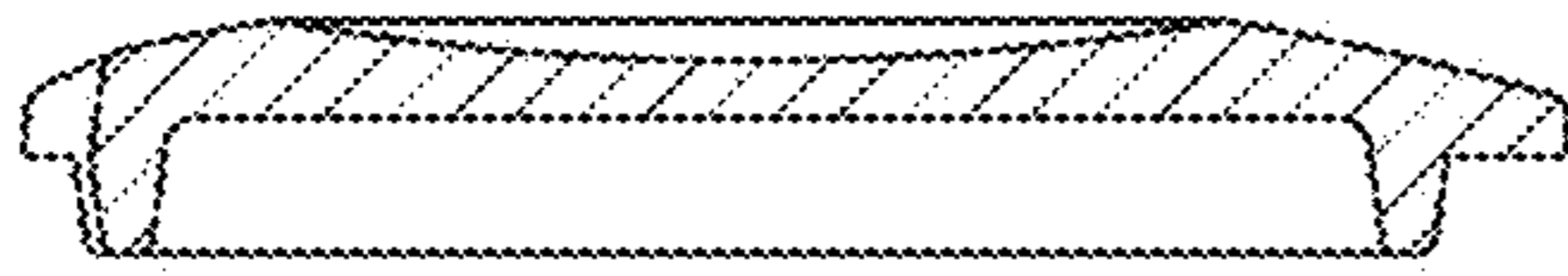

Fig. 44

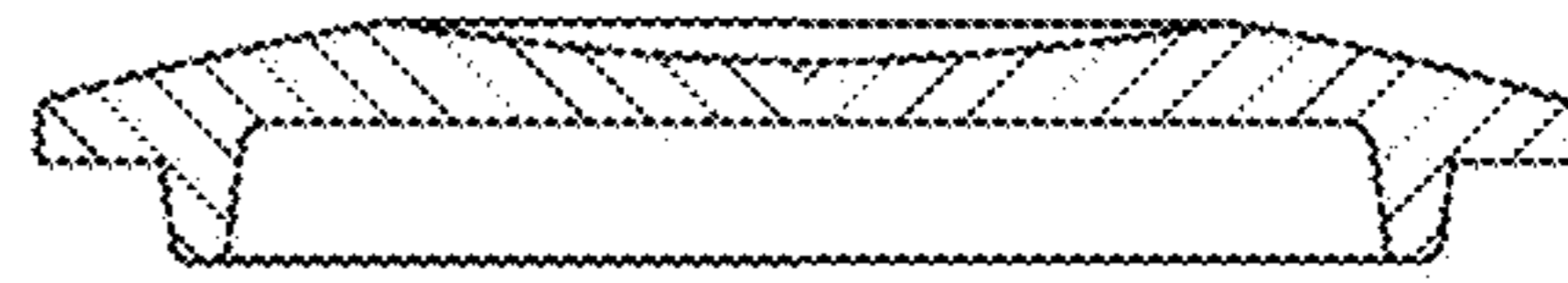

Fig. 45

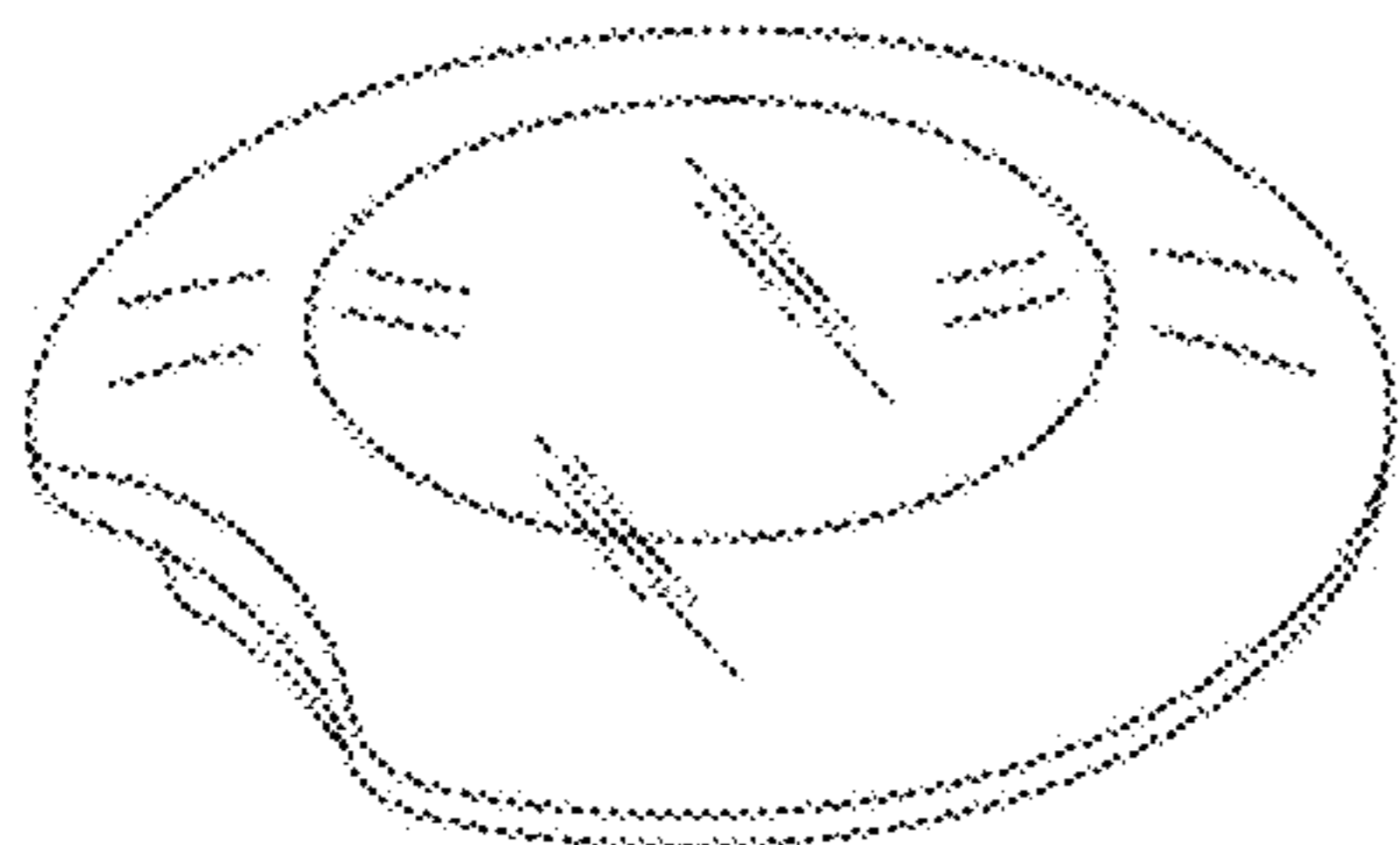

Fig. 46

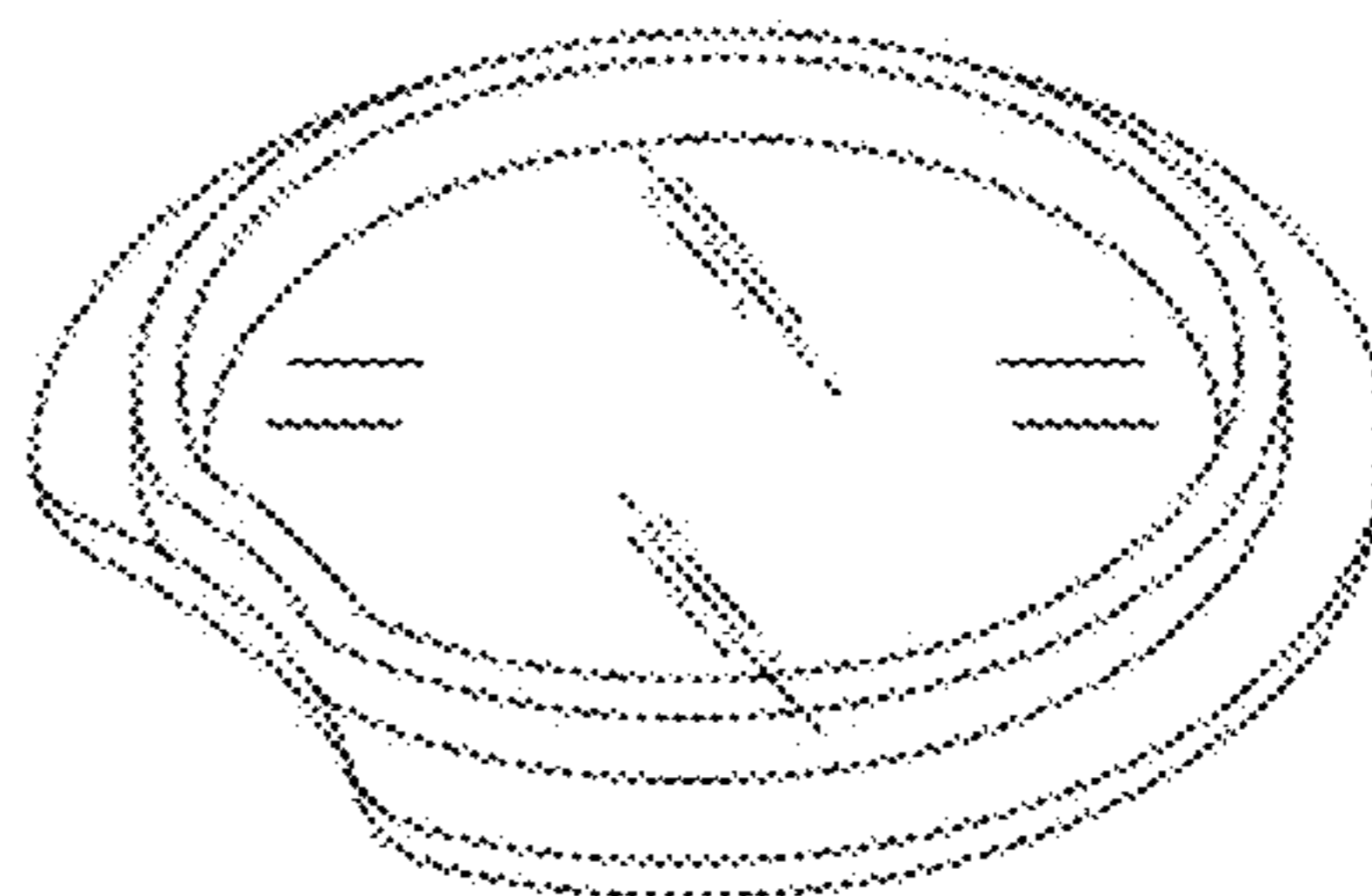

Fig. 47

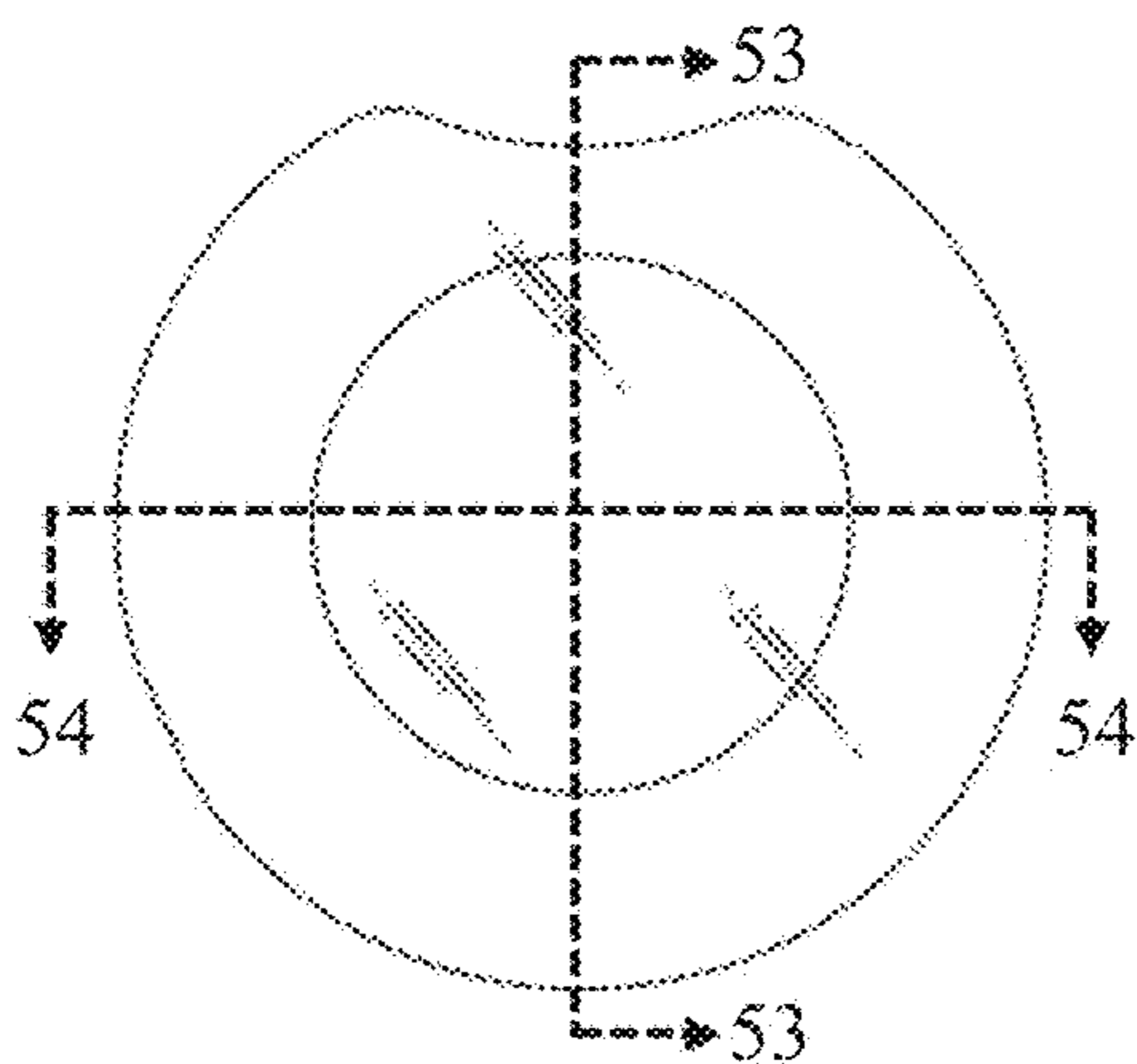

Fig. 48

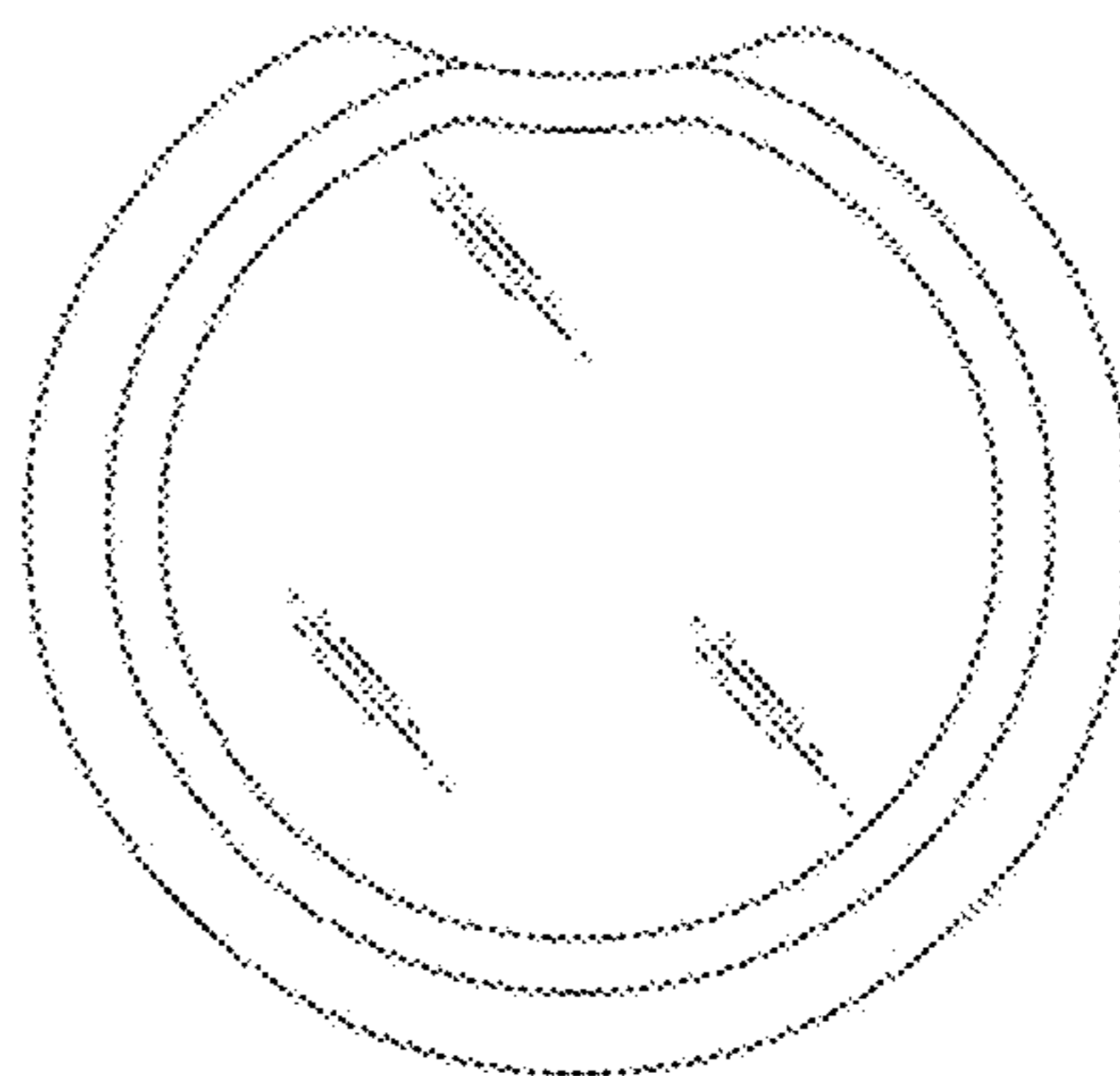

Fig. 49

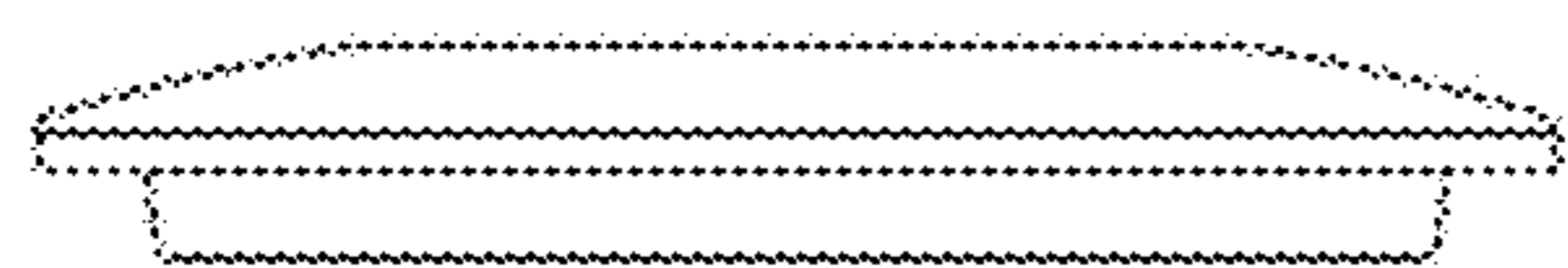

Fig. 50

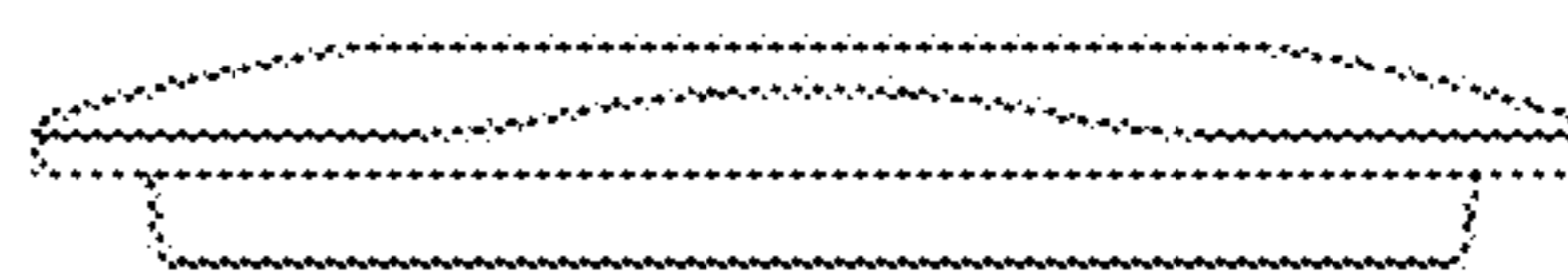

Fig. 51

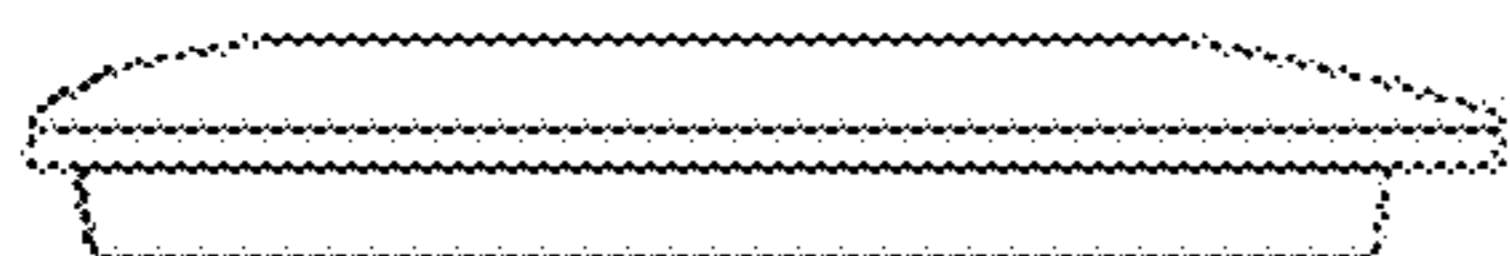

Fig. 52

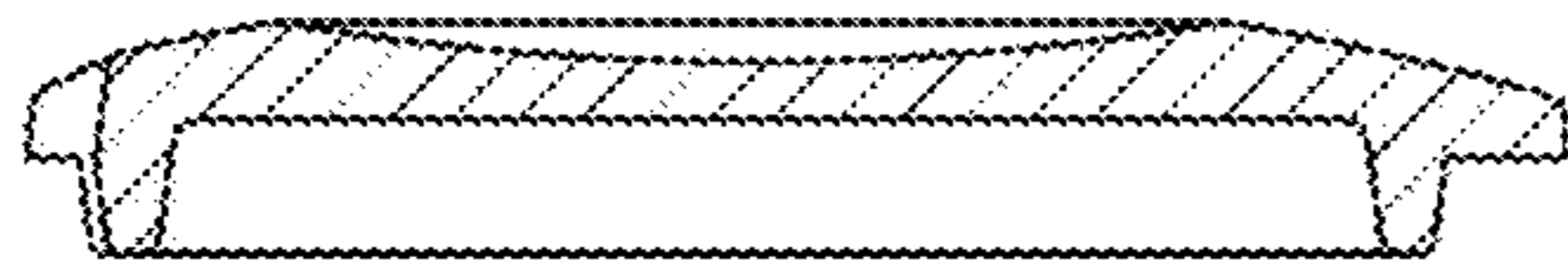

Fig. 53

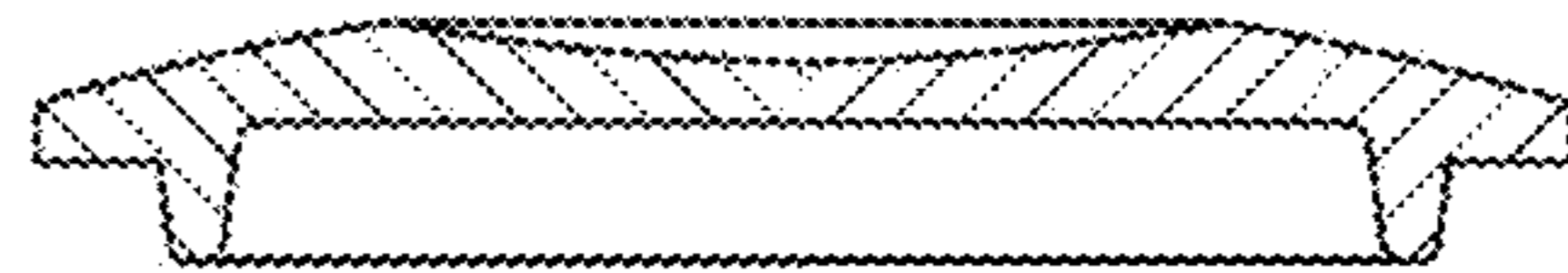

Fig. 54

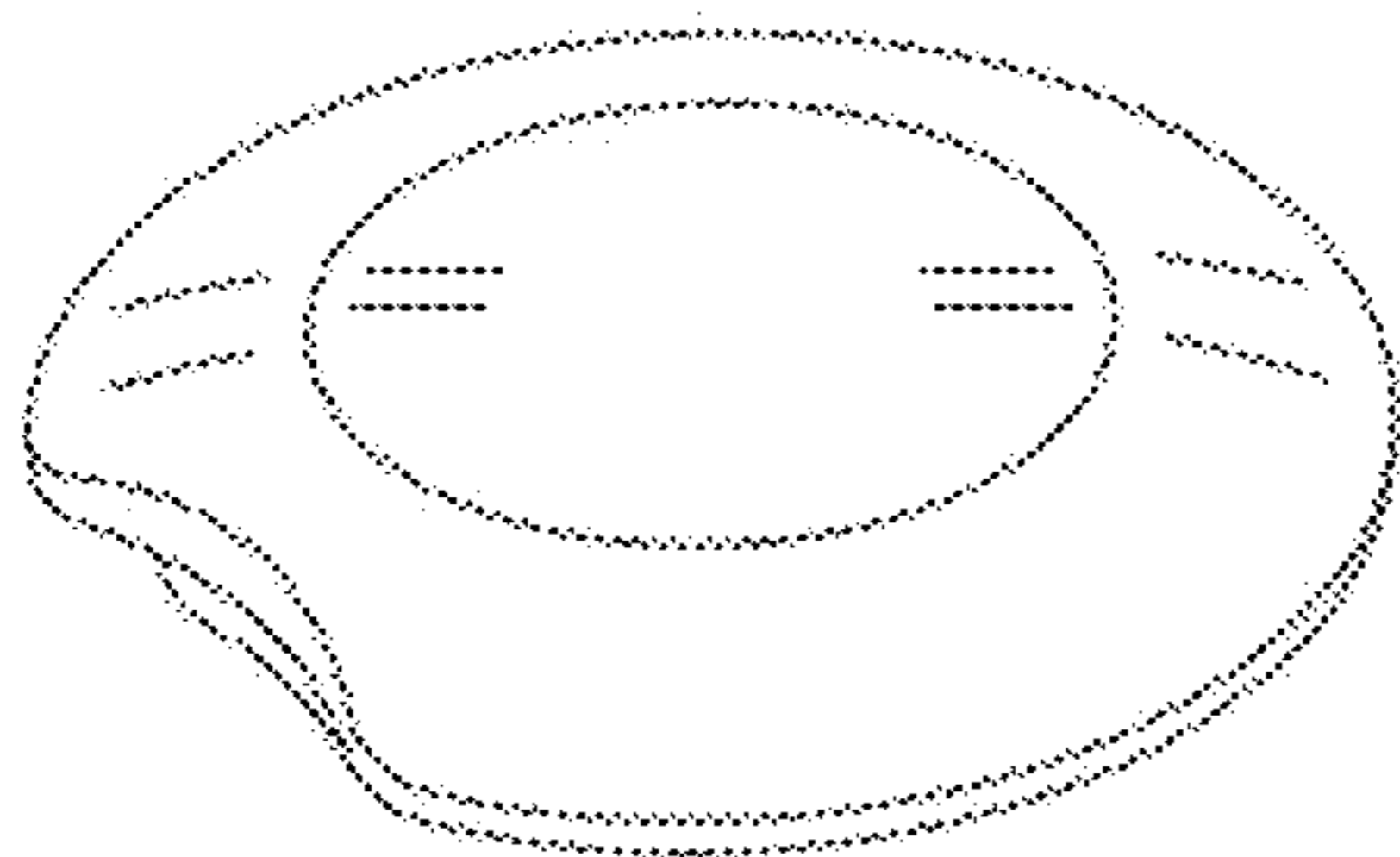

Fig. 55

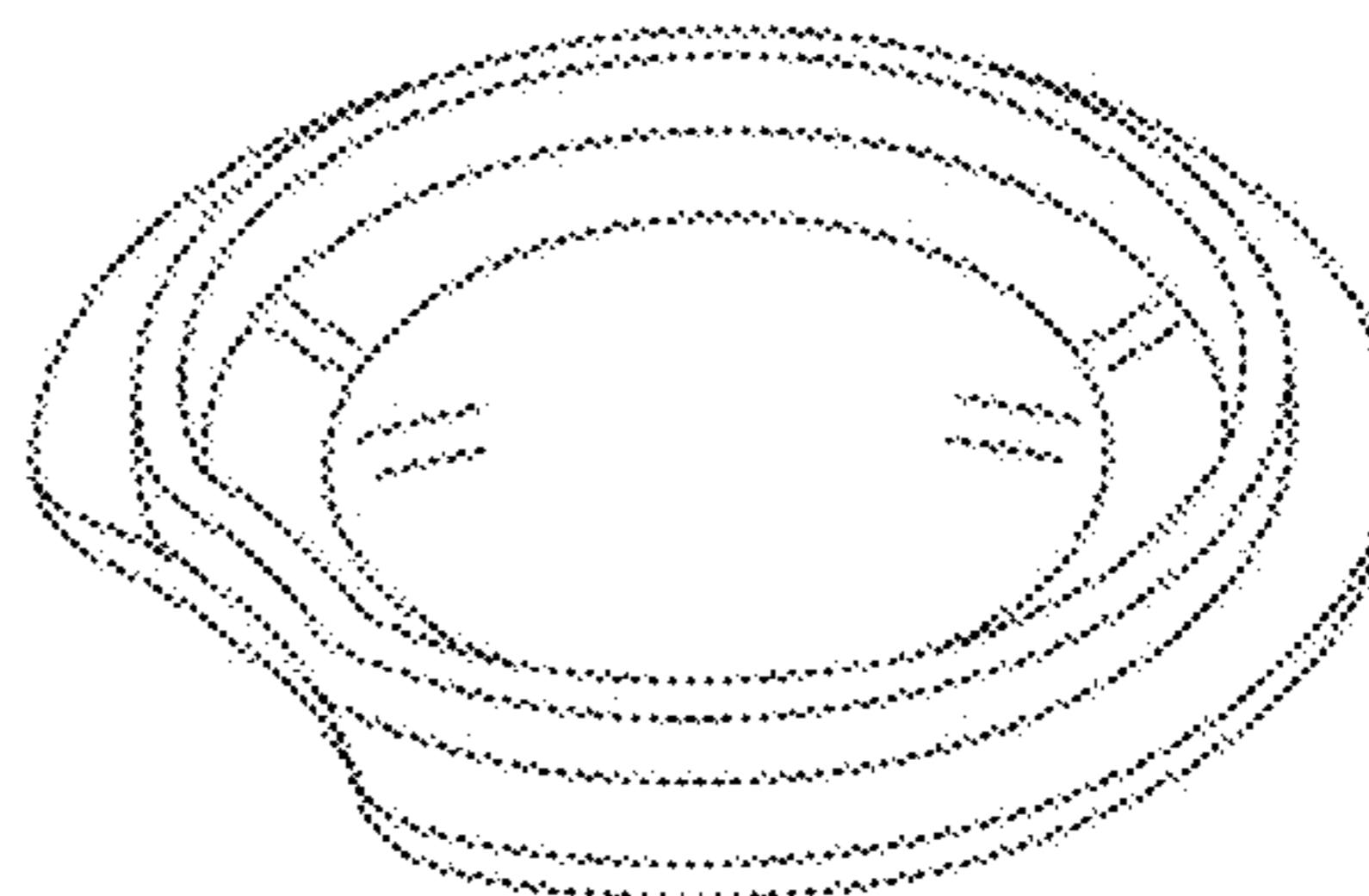

Fig. 56

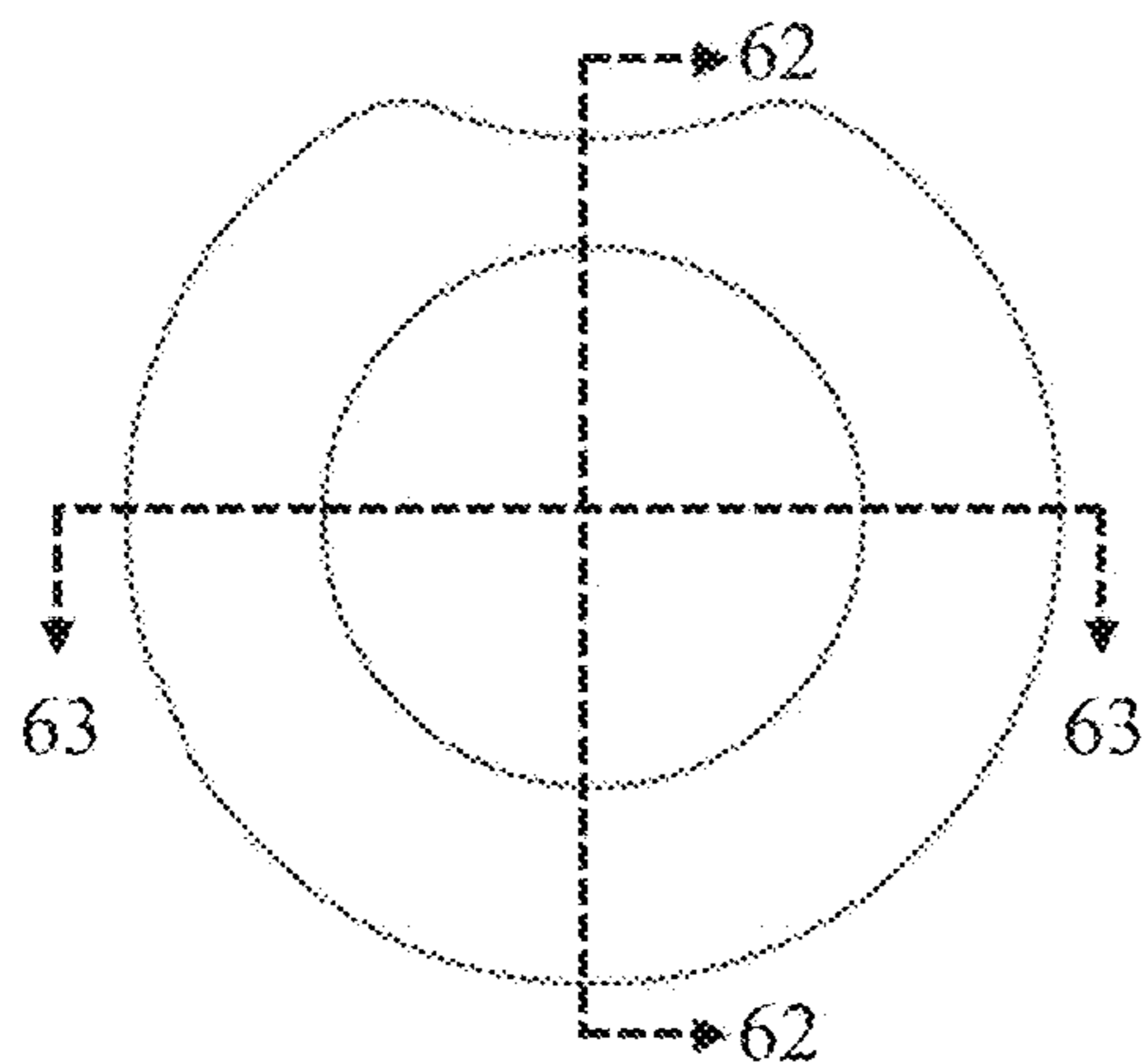

Fig. 57

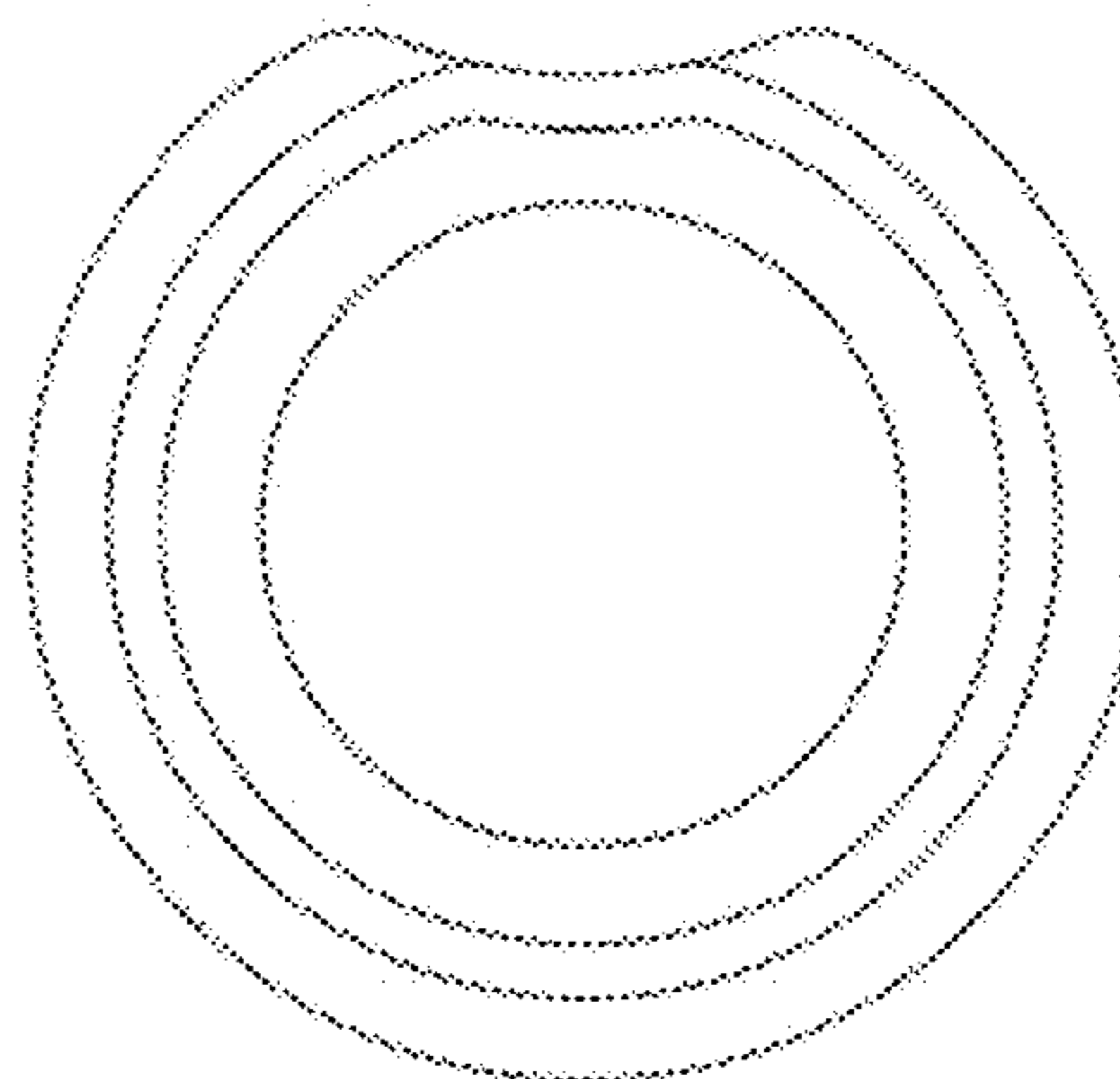

Fig. 58

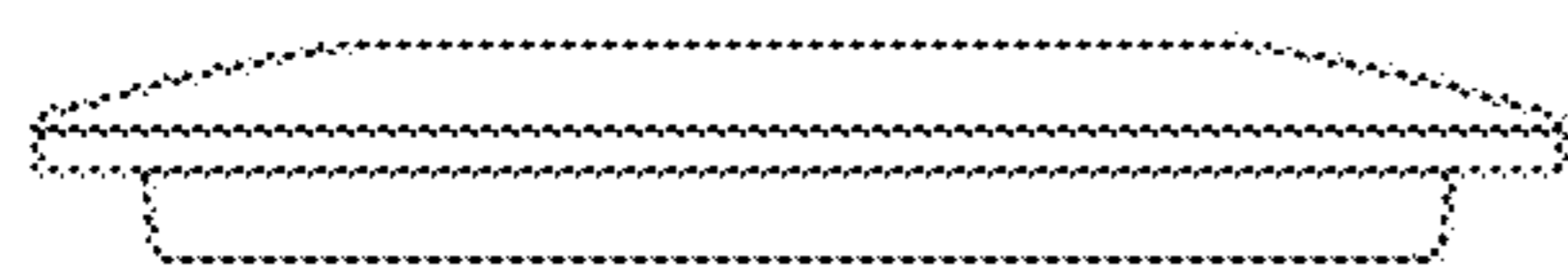

Fig. 59

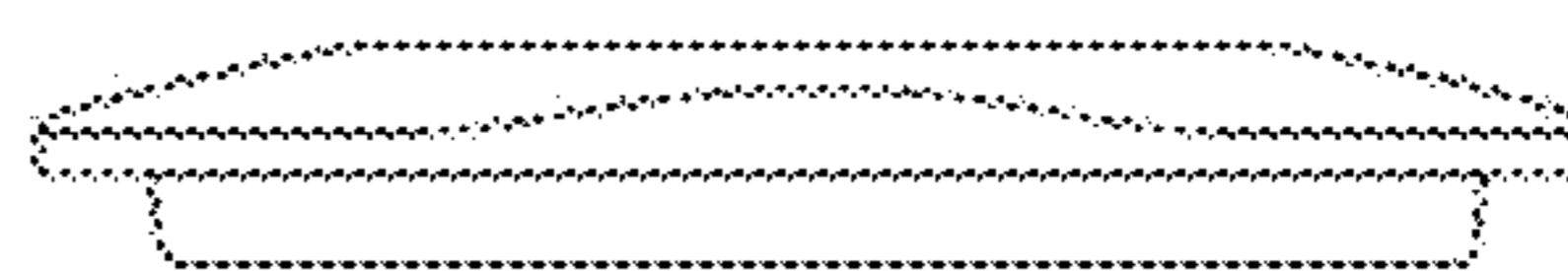

Fig. 60

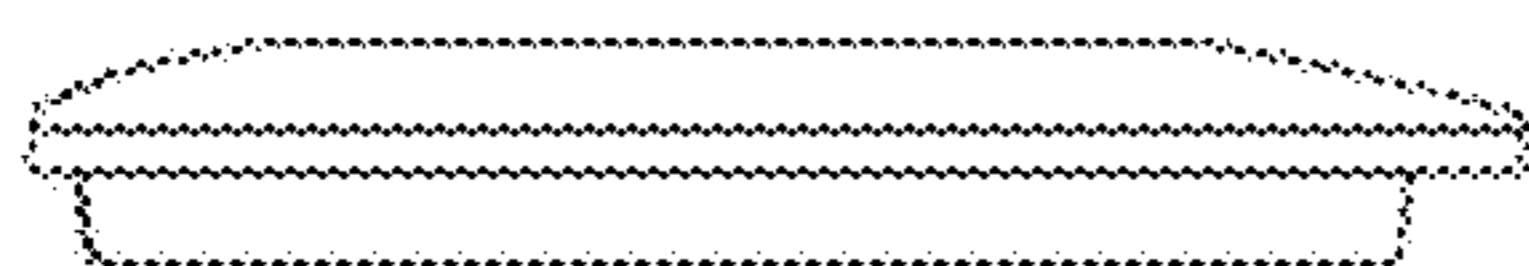

Fig. 61



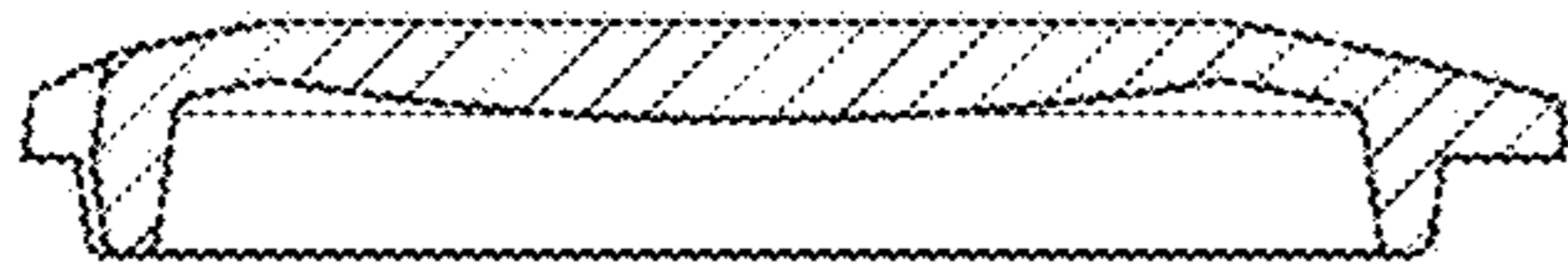

Fig. 62

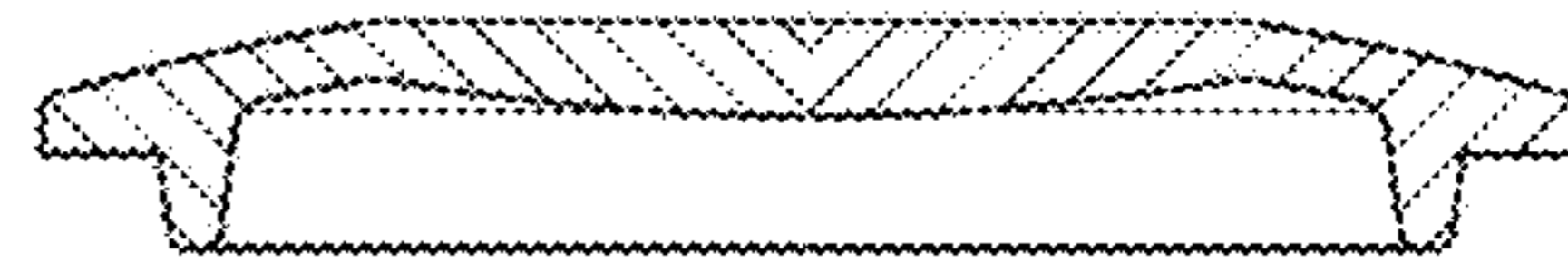

Fig. 63

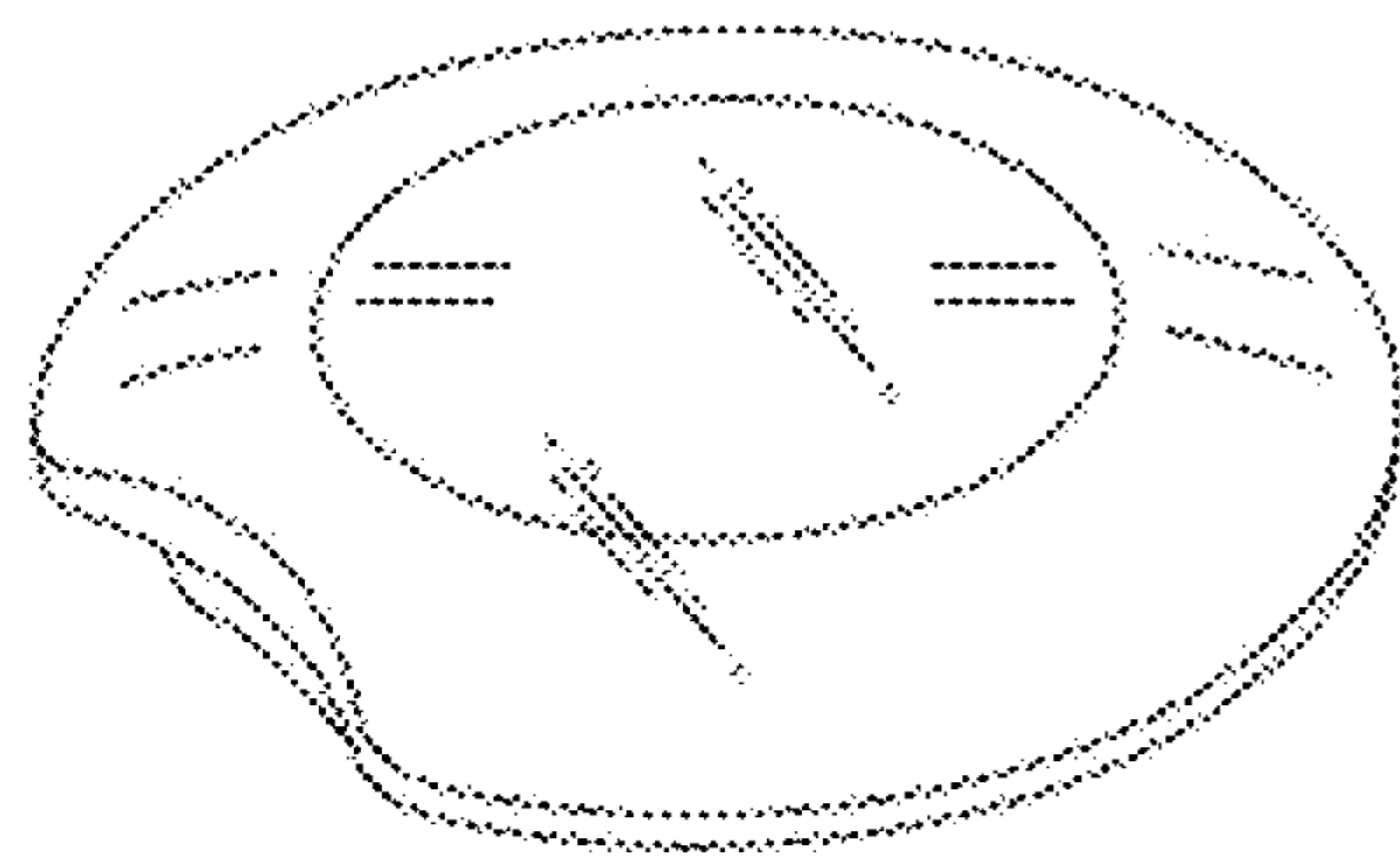

Fig. 64

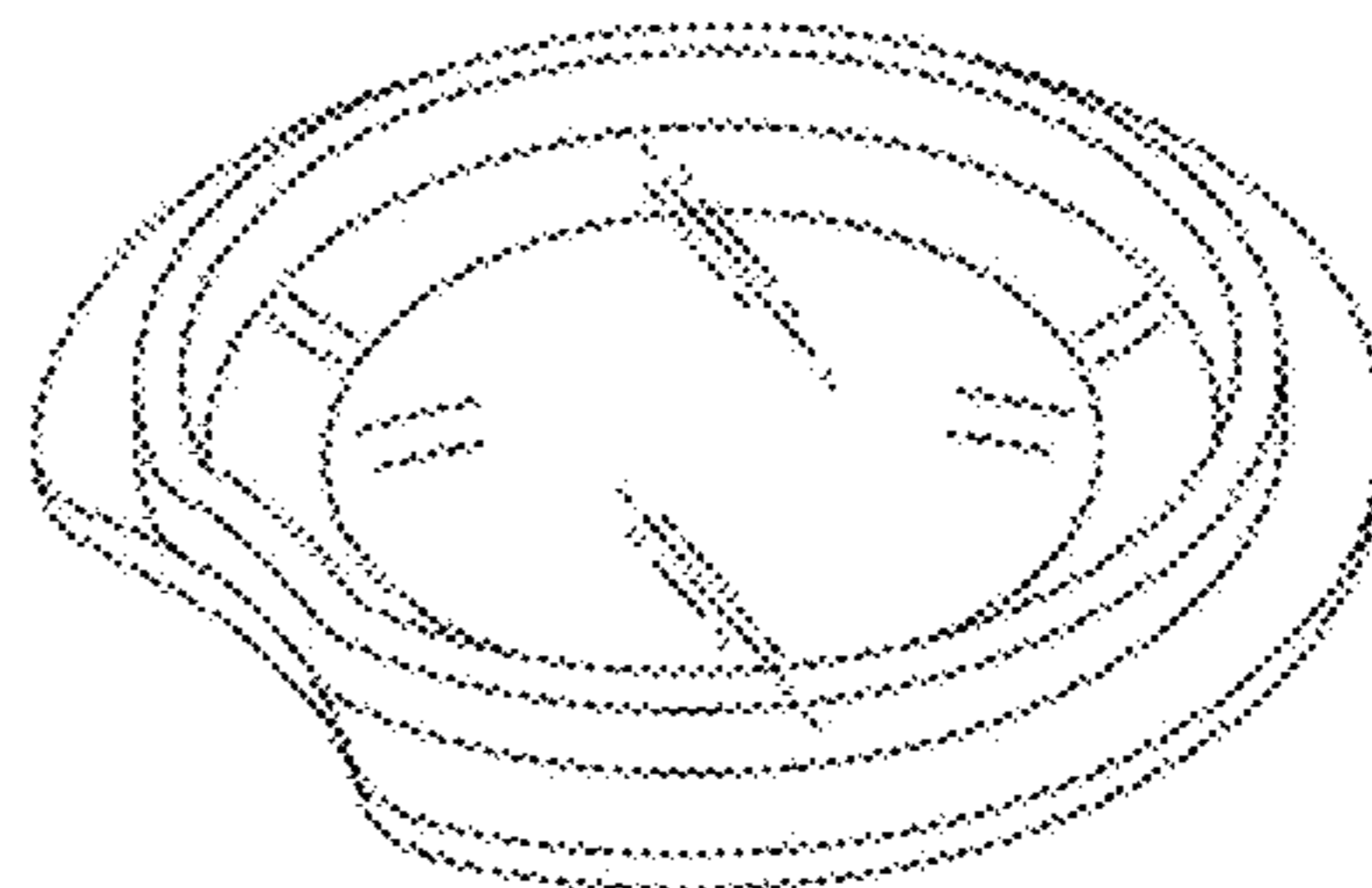

Fig. 65

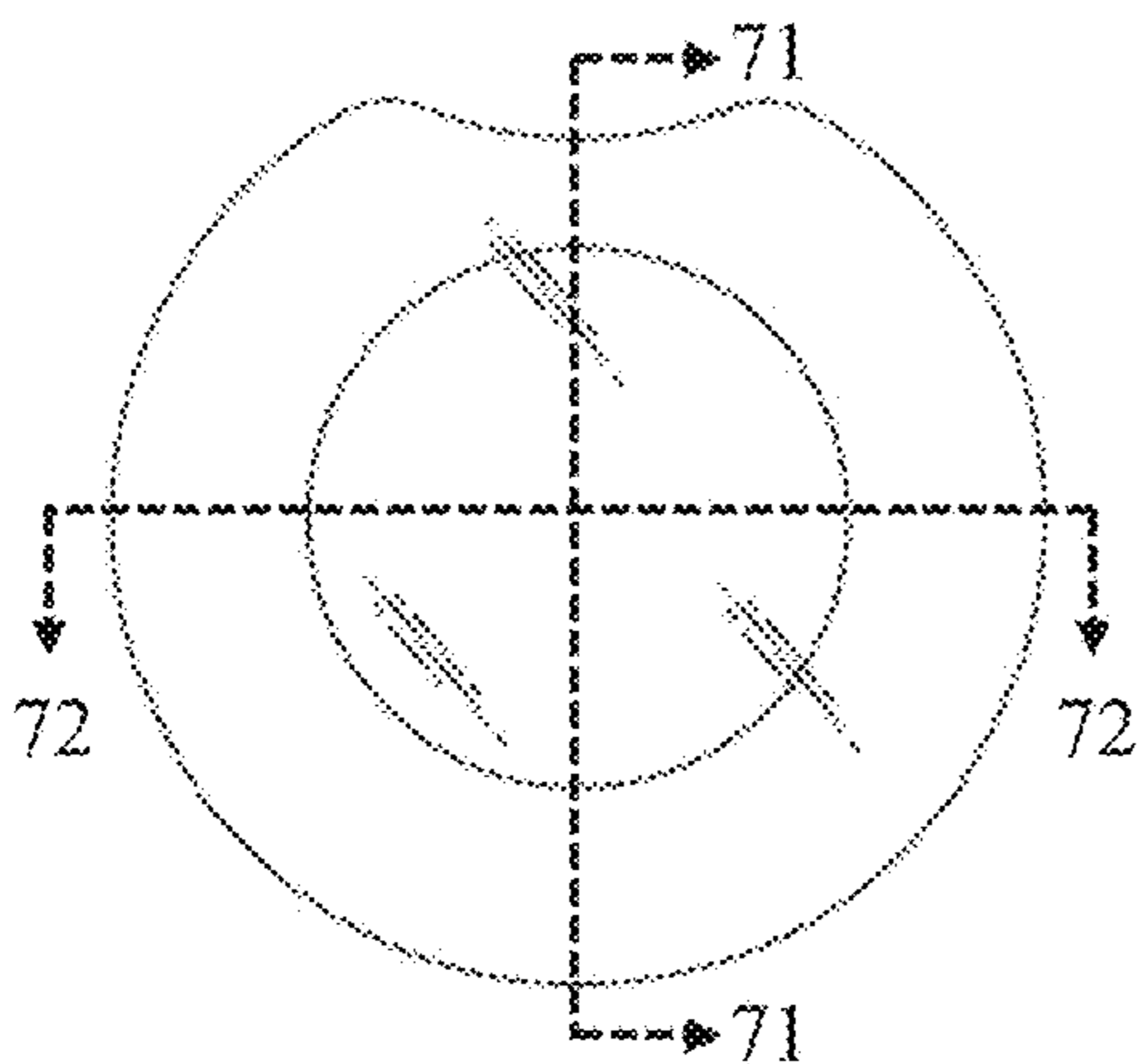

Fig. 66

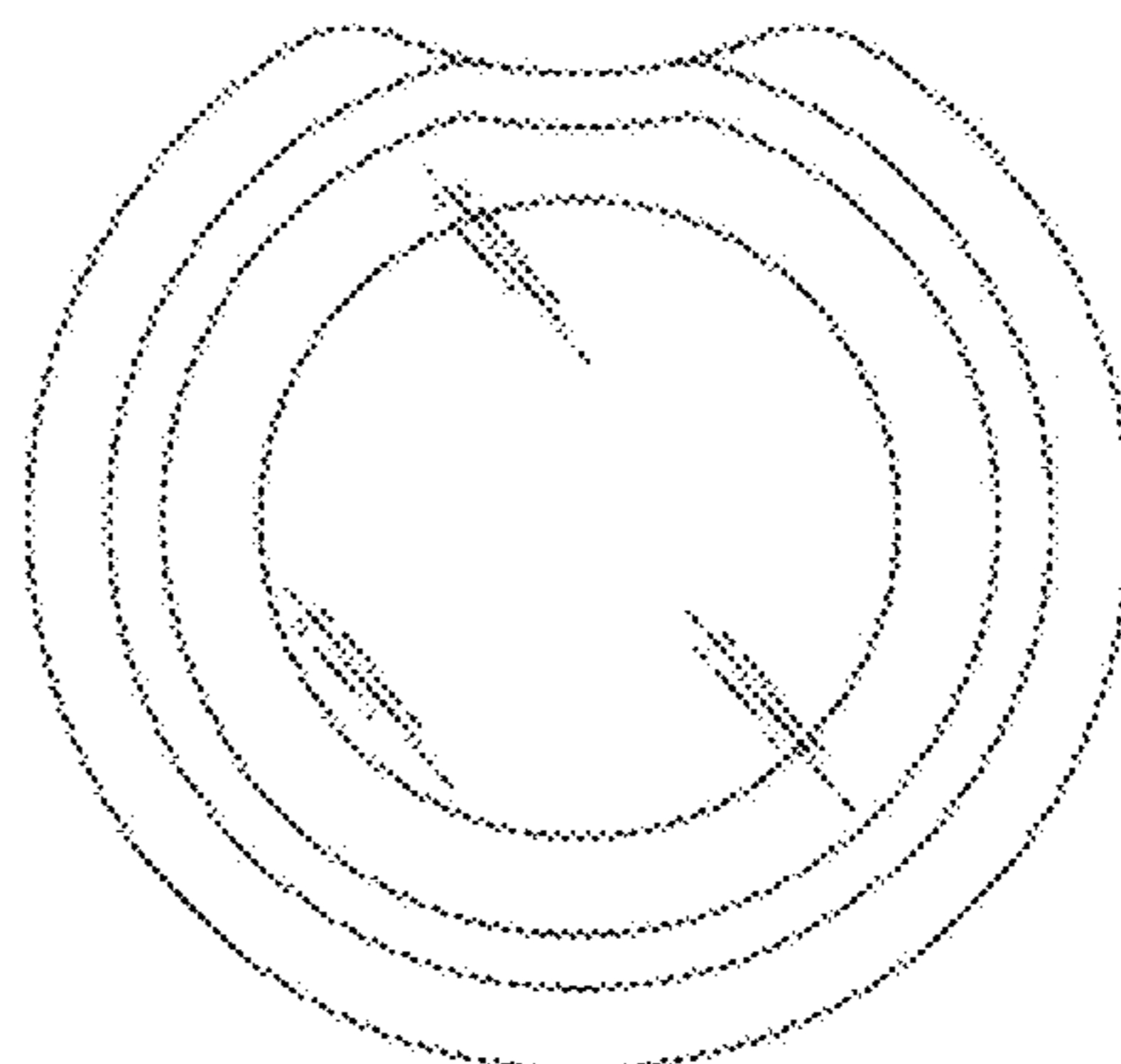

Fig. 67



Fig. 68

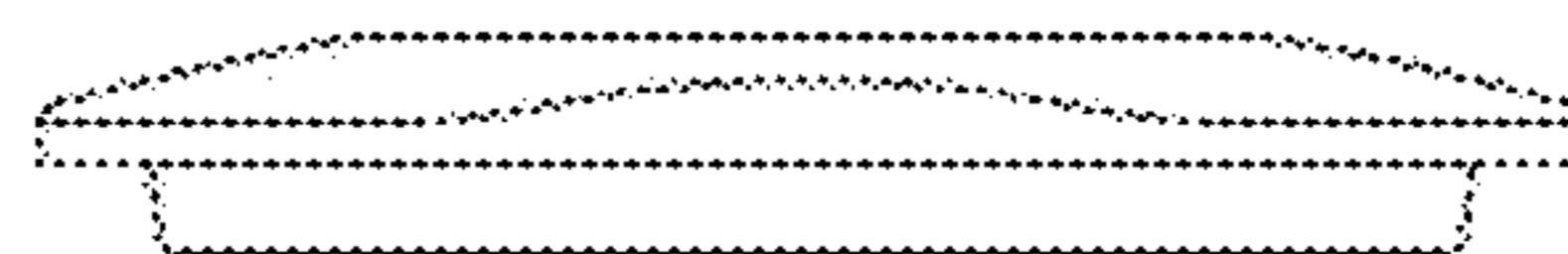

Fig. 69

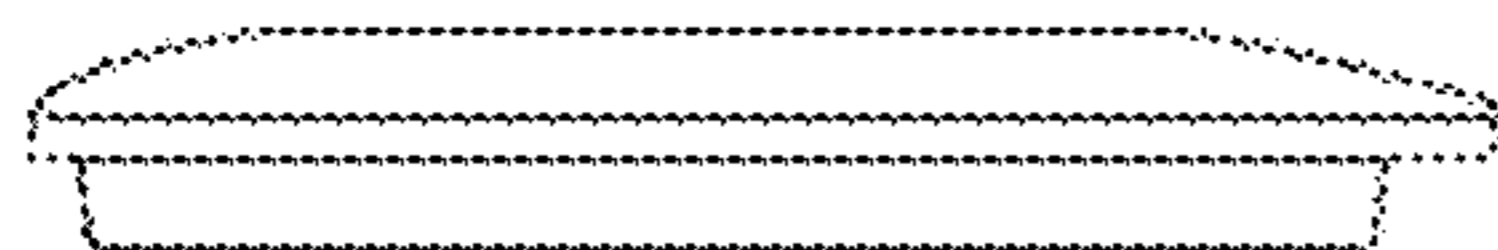

Fig. 70

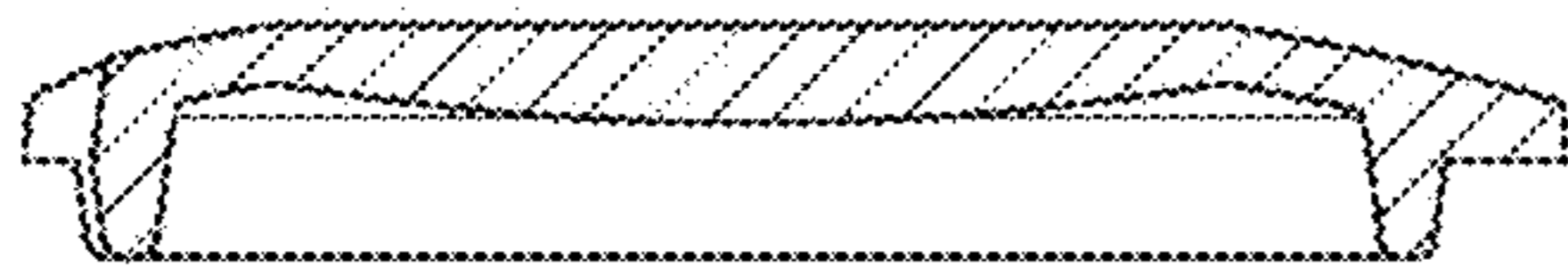

Fig. 71

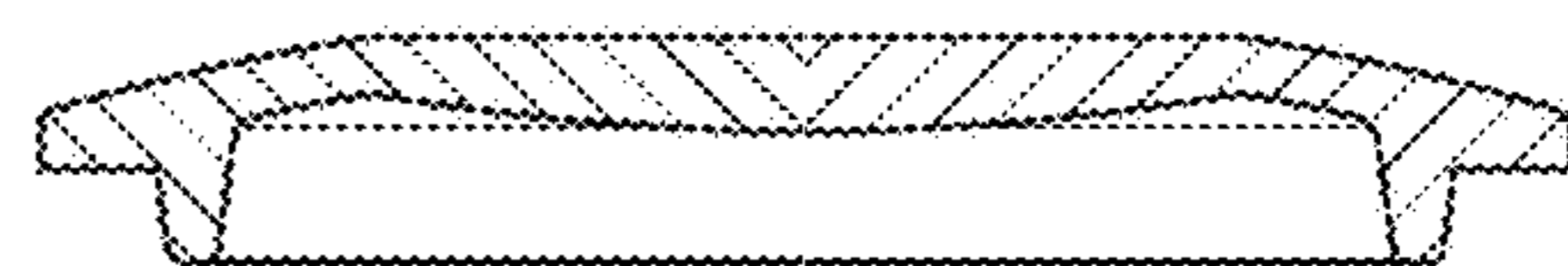

Fig. 72

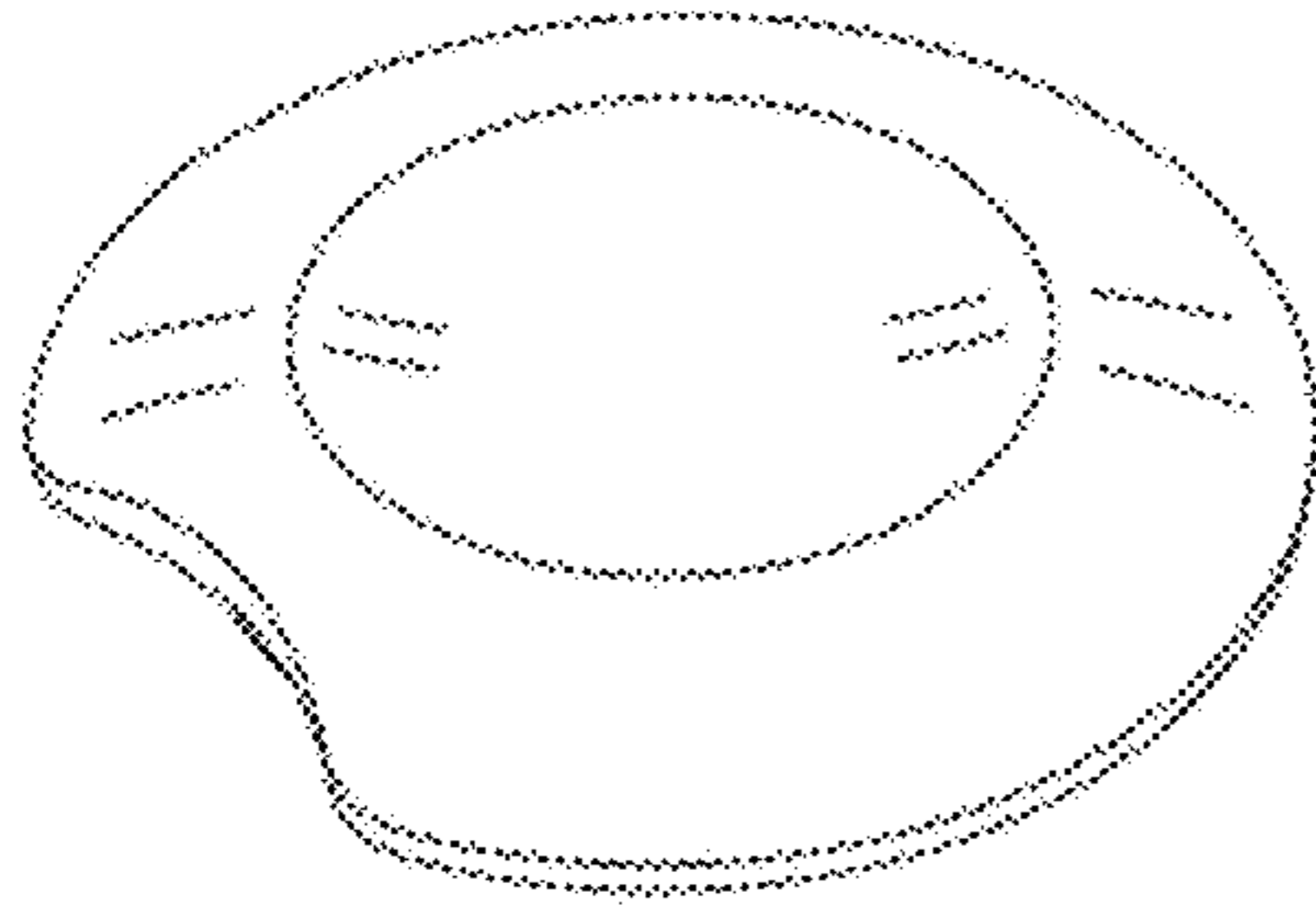

Fig. 73

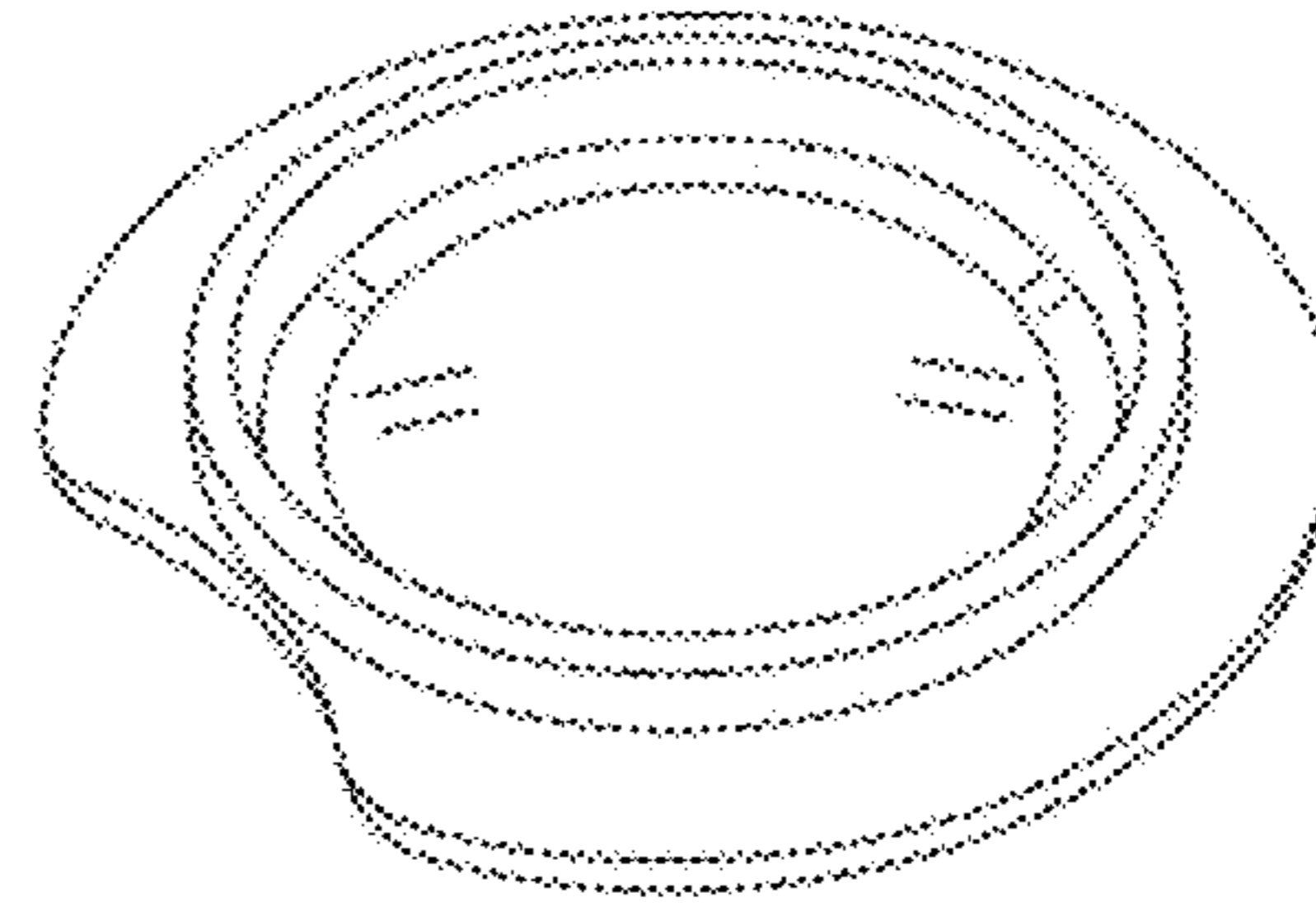

Fig. 74

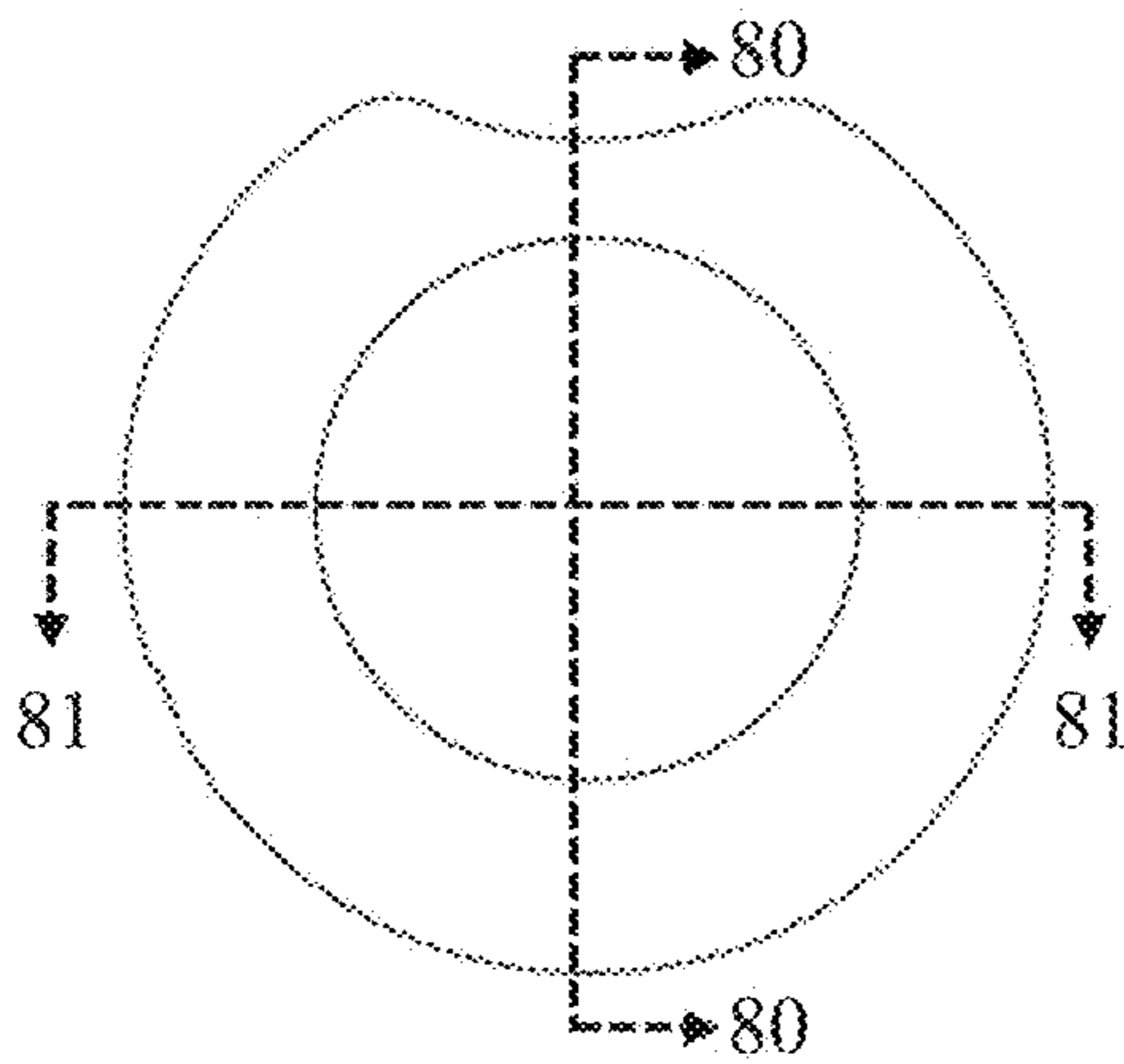

Fig. 75

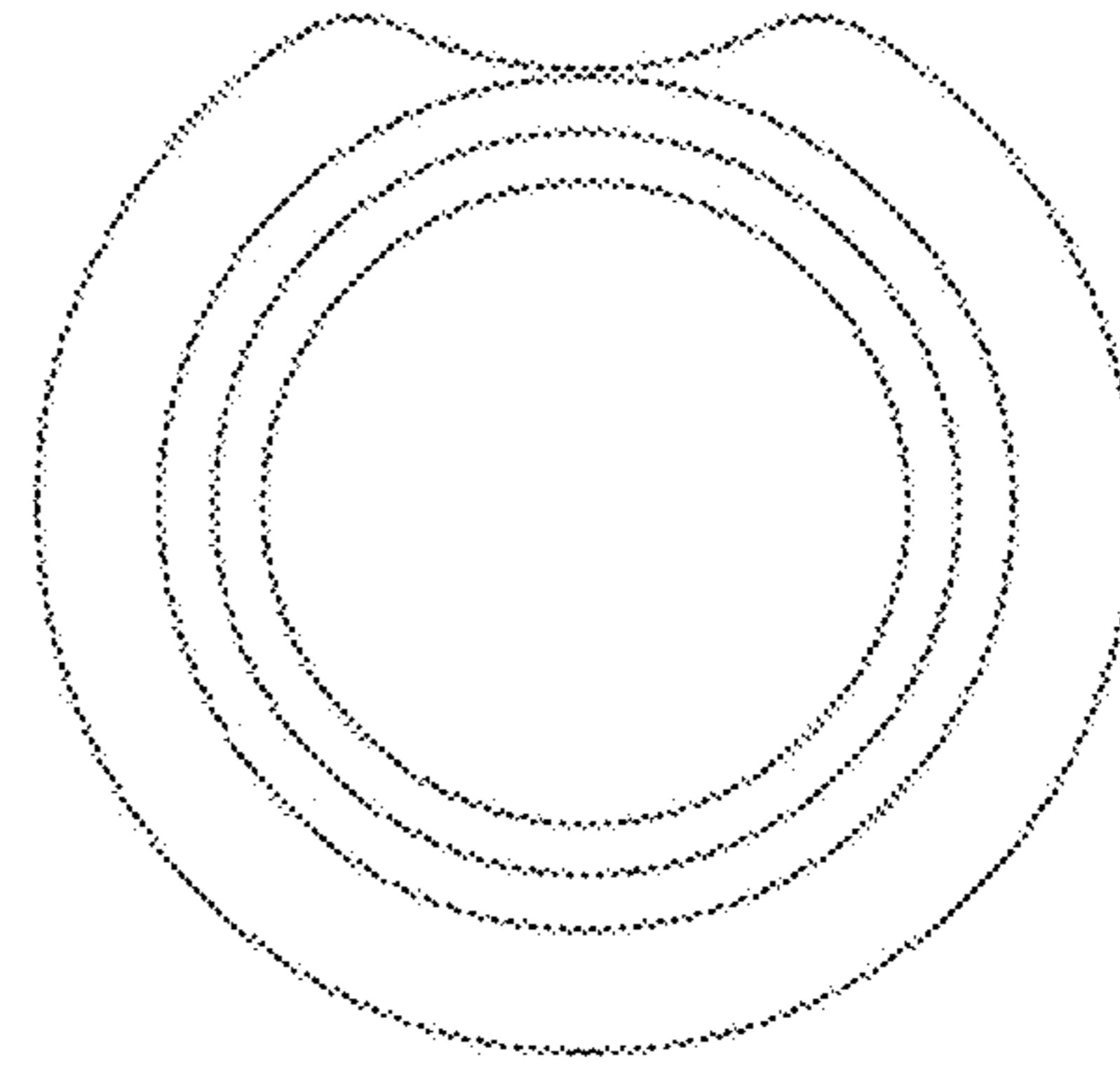

Fig. 76

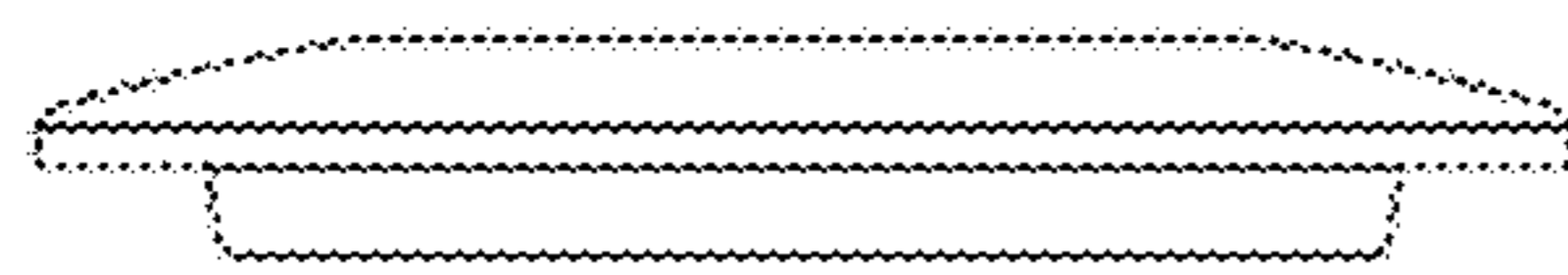

Fig. 77

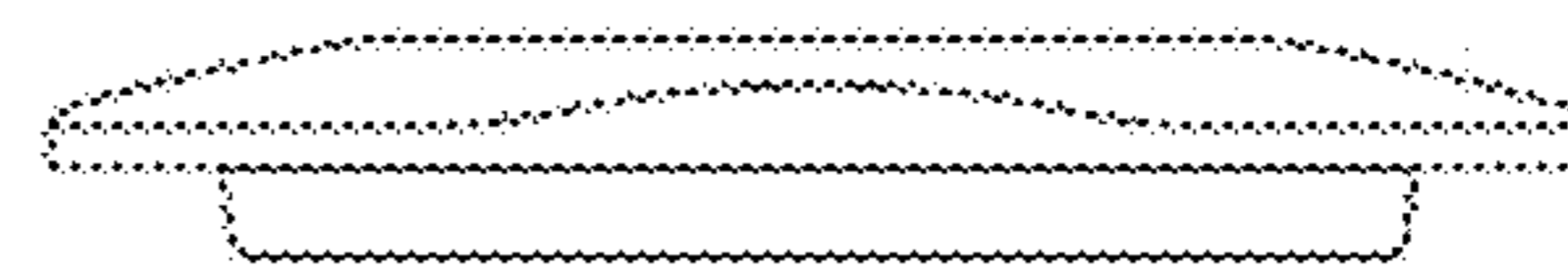

Fig. 78

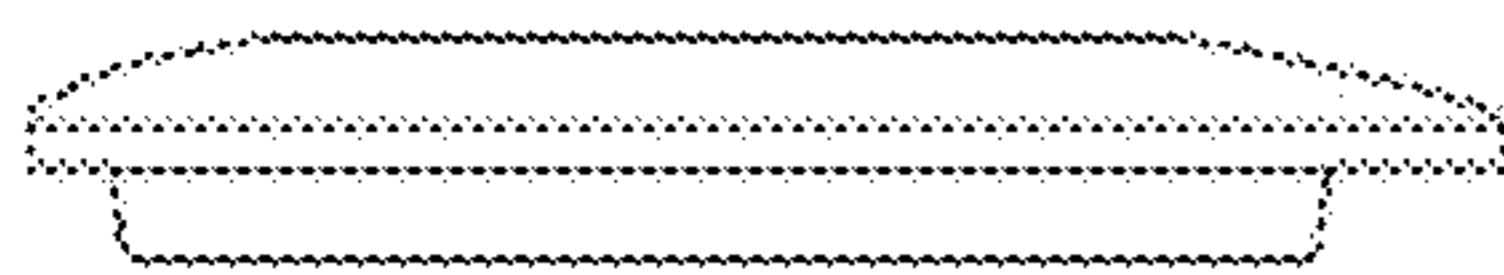

Fig. 79



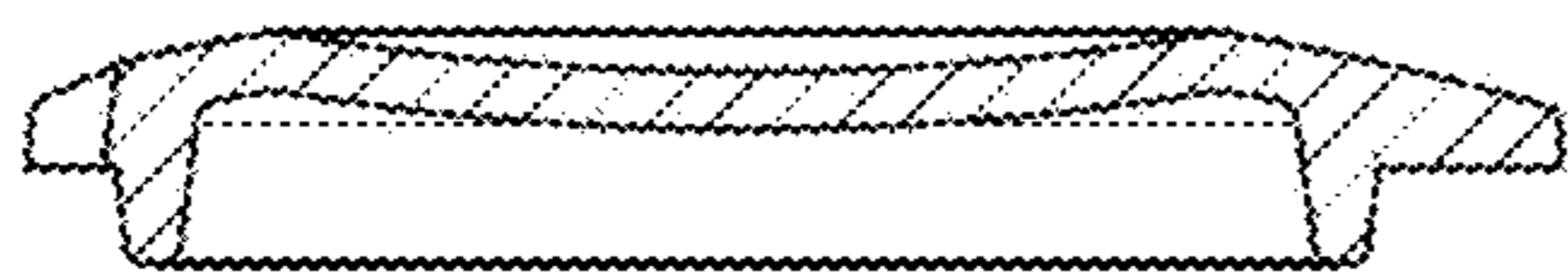

Fig. 80

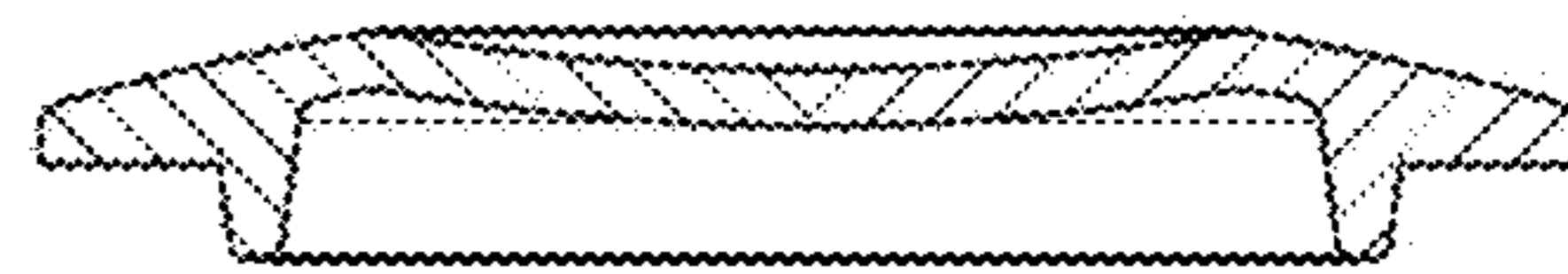

Fig. 81

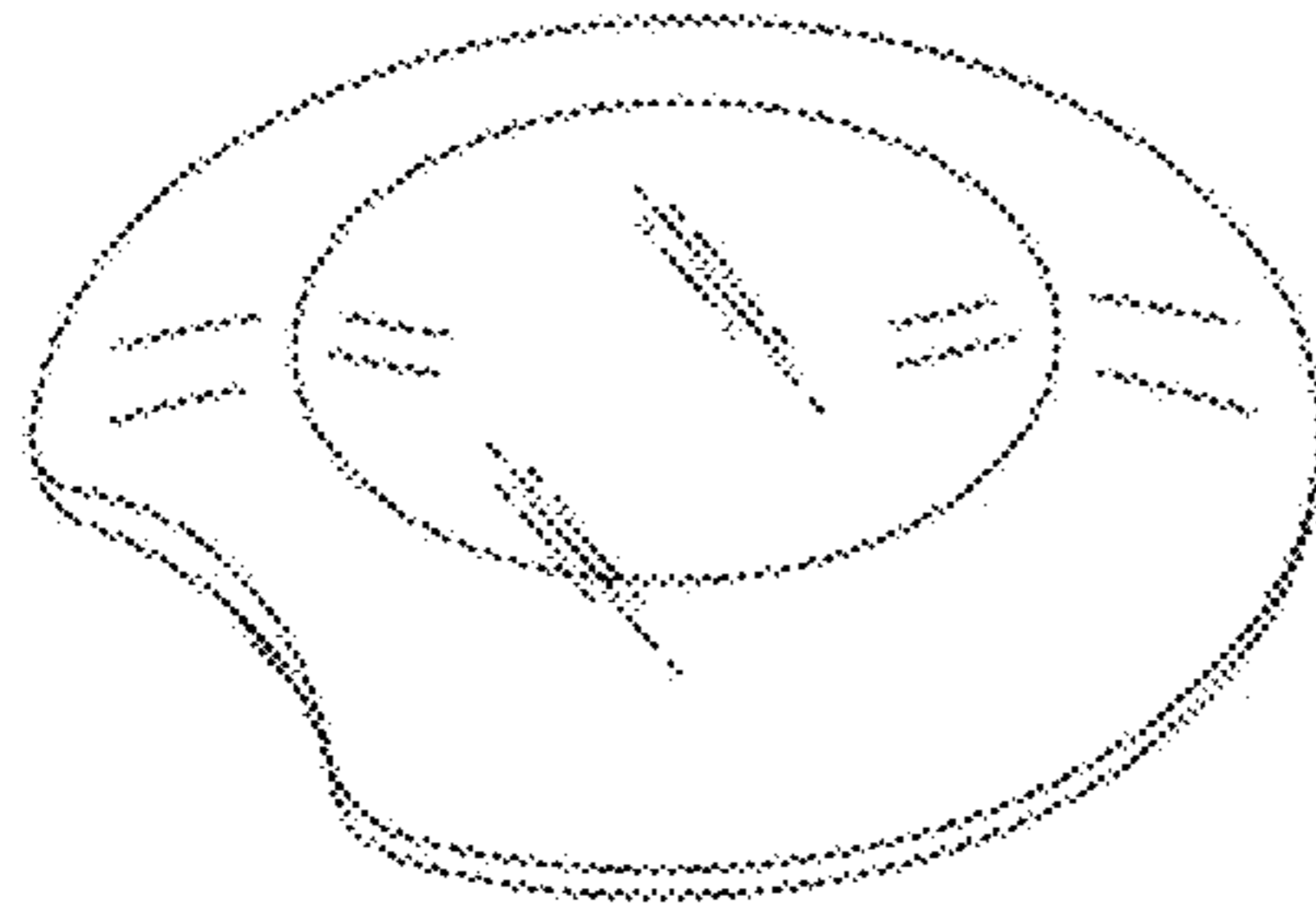

Fig. 82

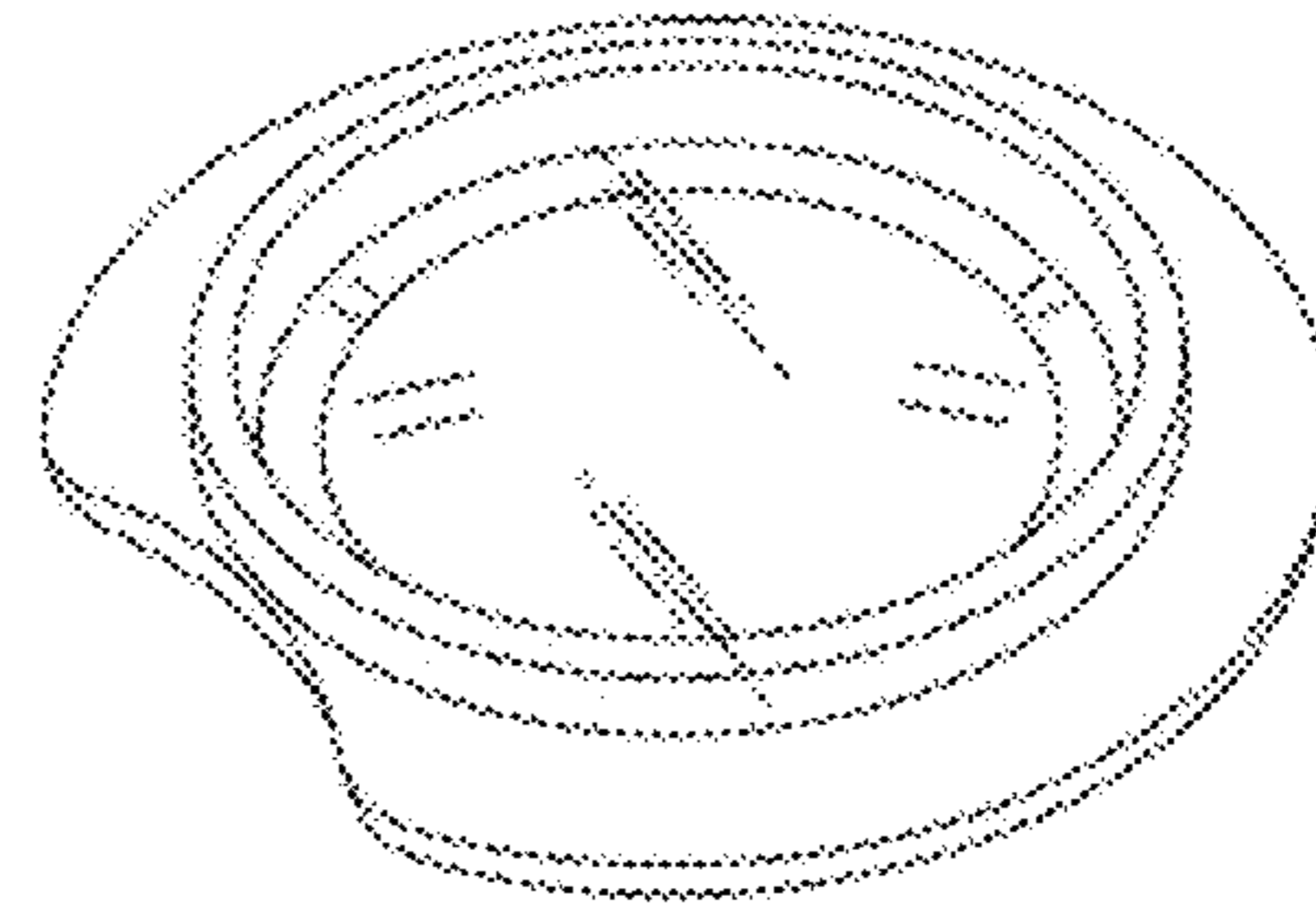

Fig. 83

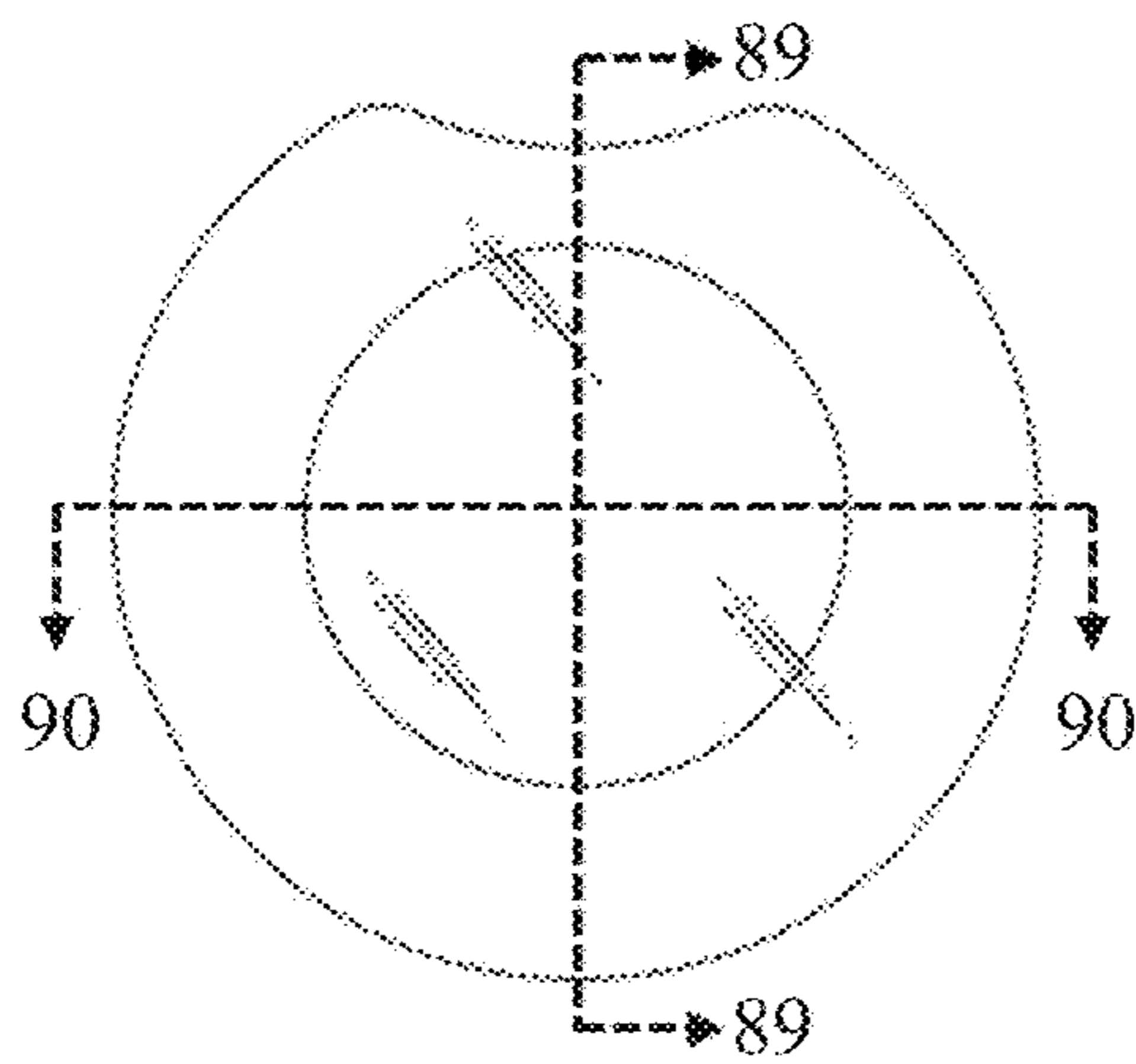

Fig. 84

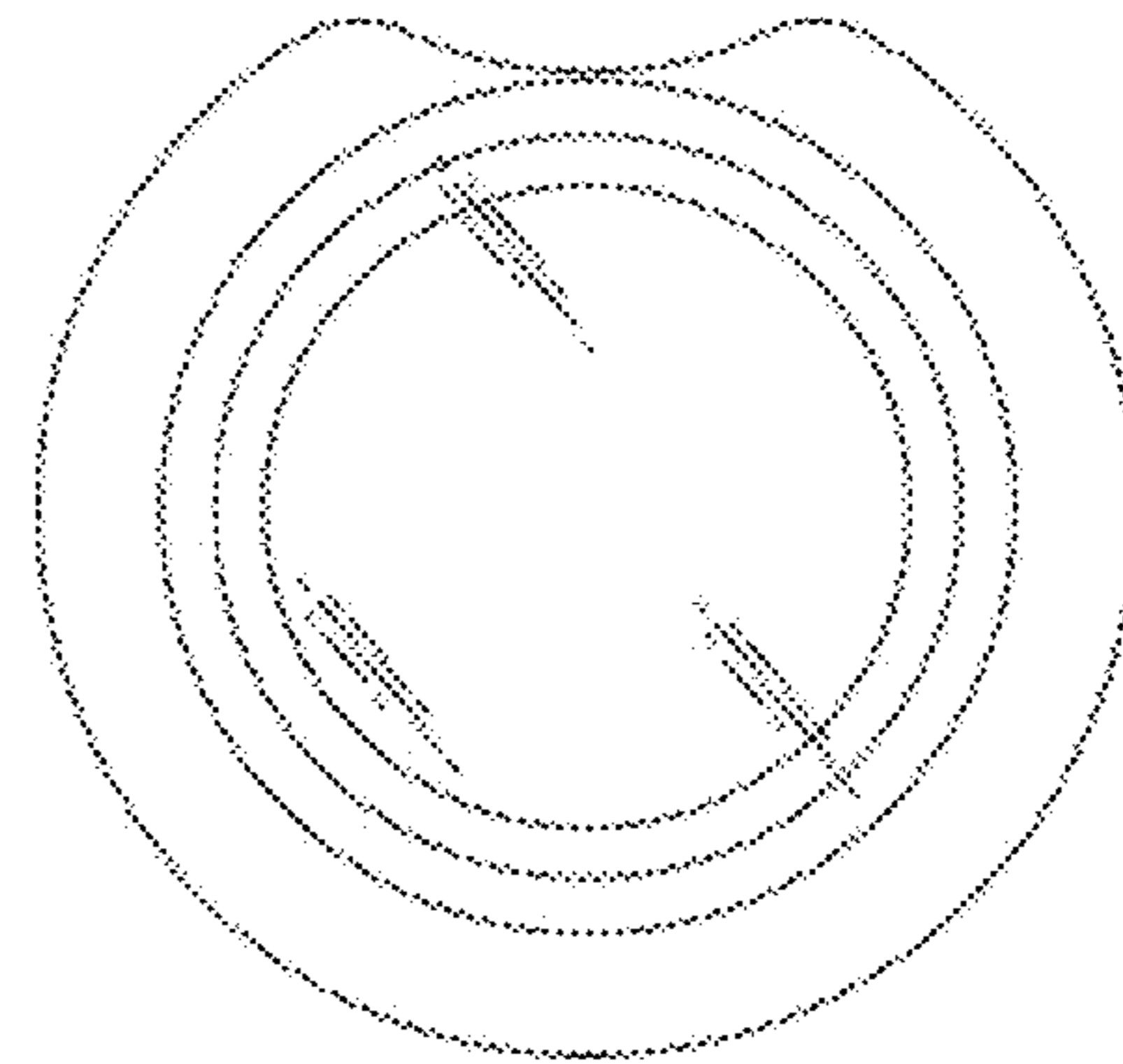

Fig. 85



Fig. 86

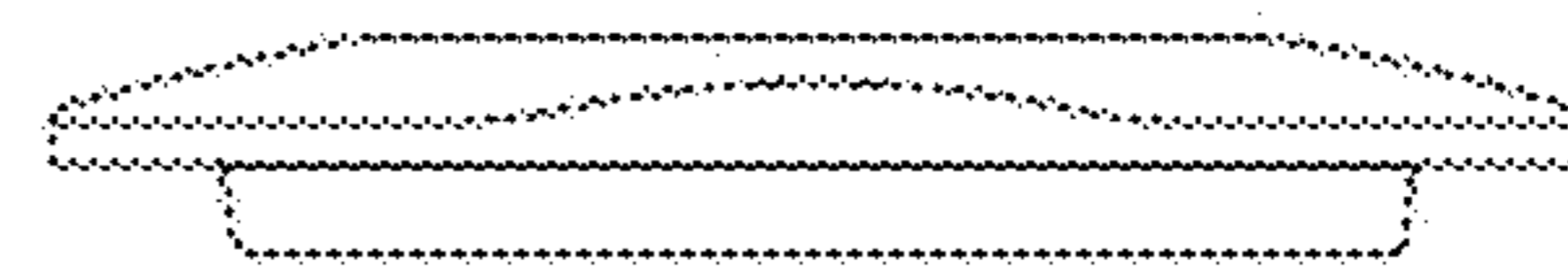

Fig. 87

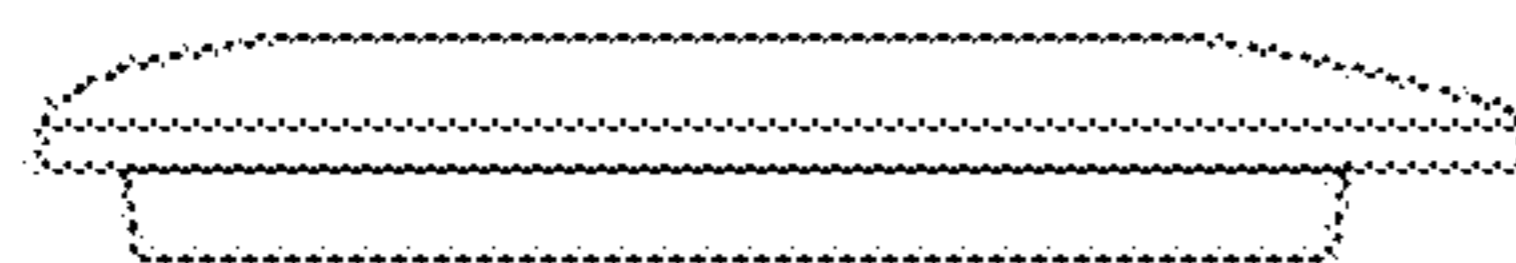
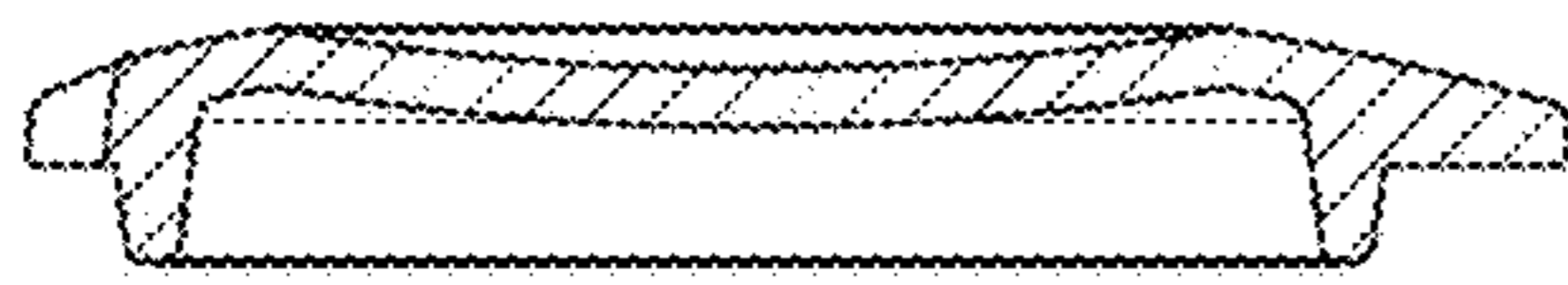
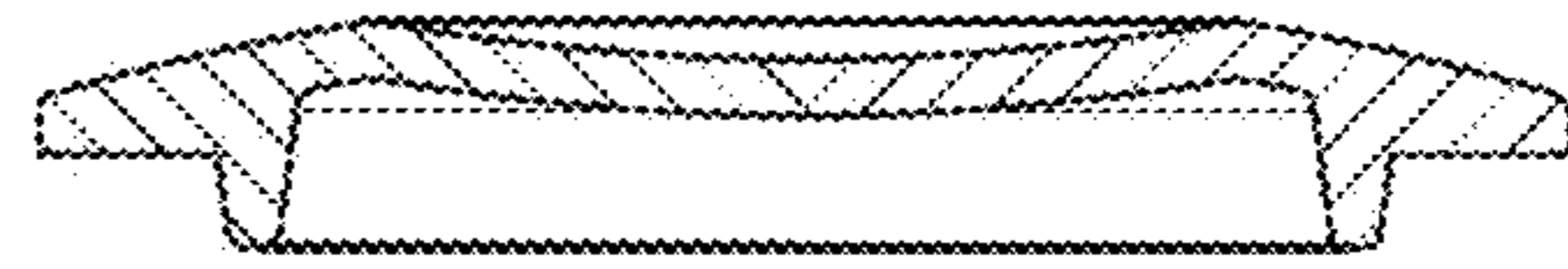

Fig. 88



*Fig. 89*



*Fig. 90*

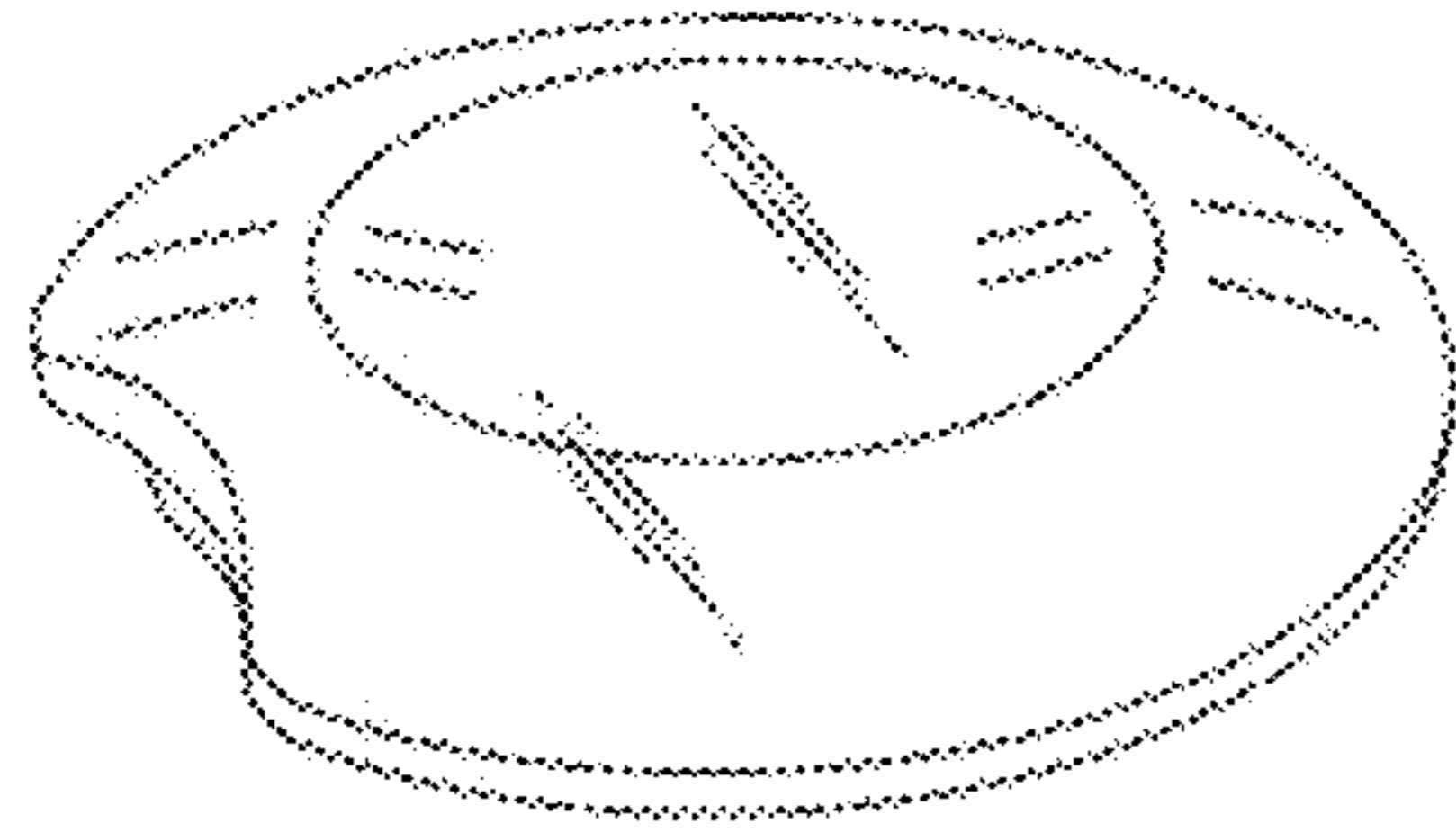

Fig. 91

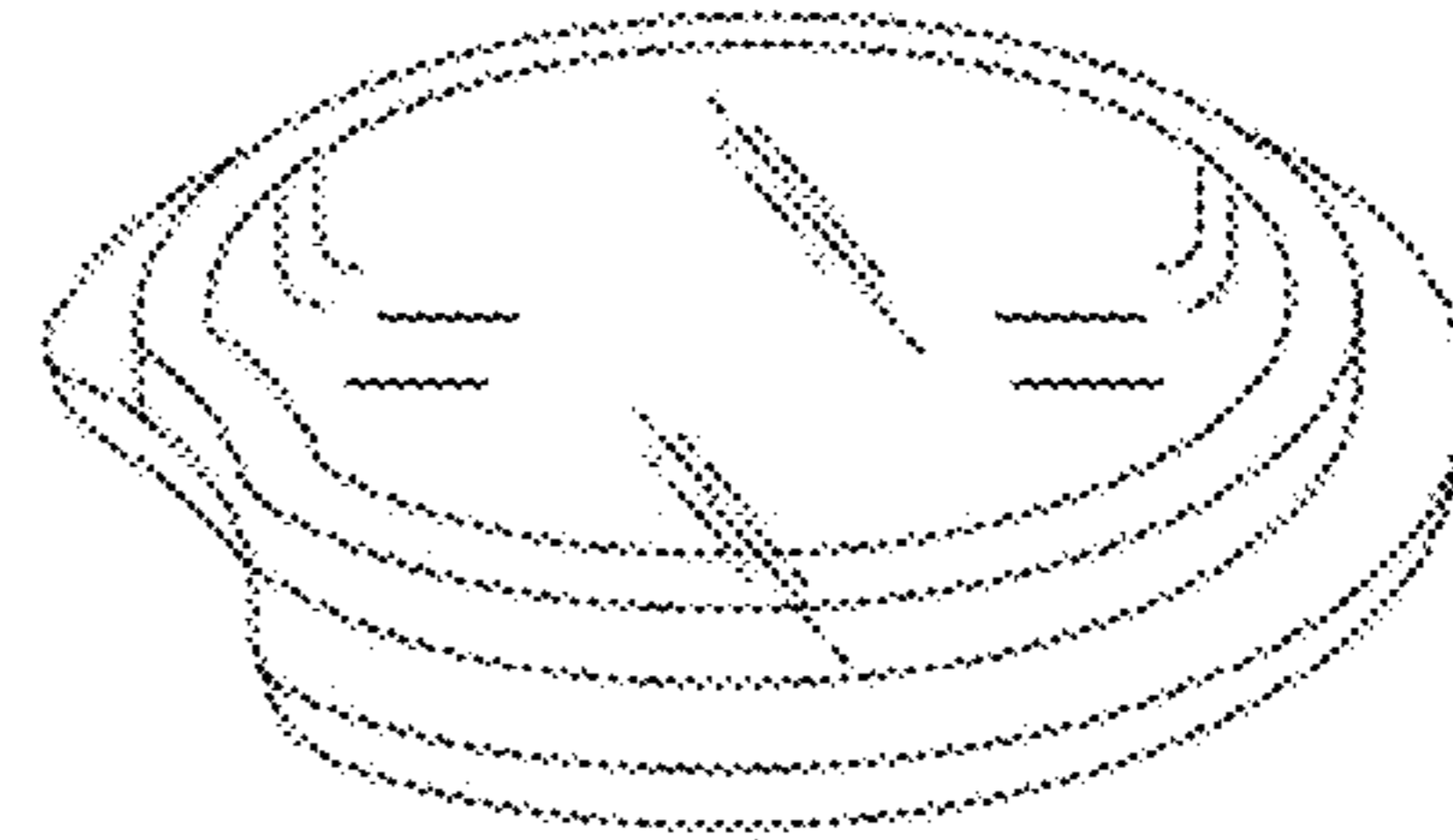

Fig. 92

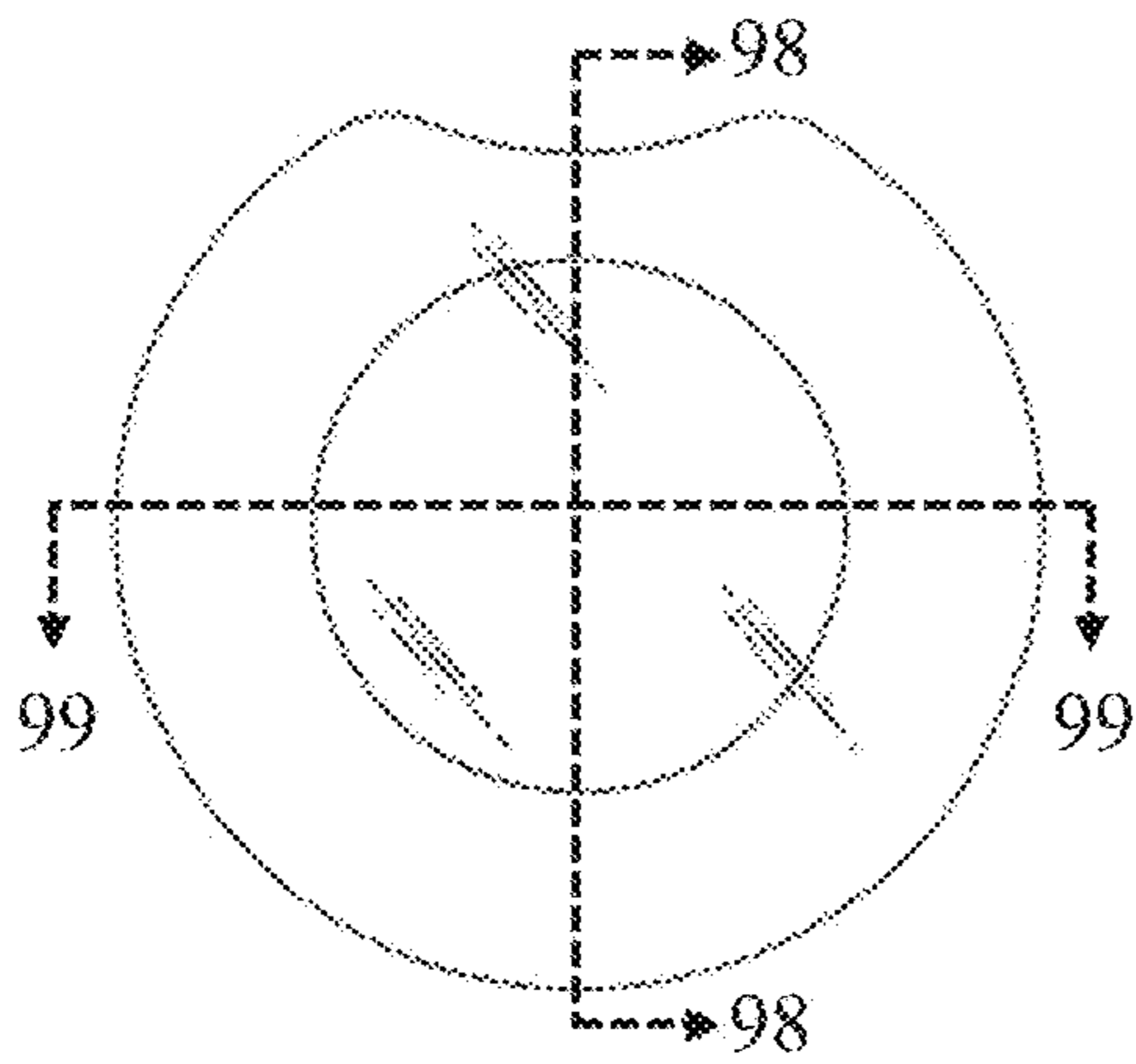

Fig. 93

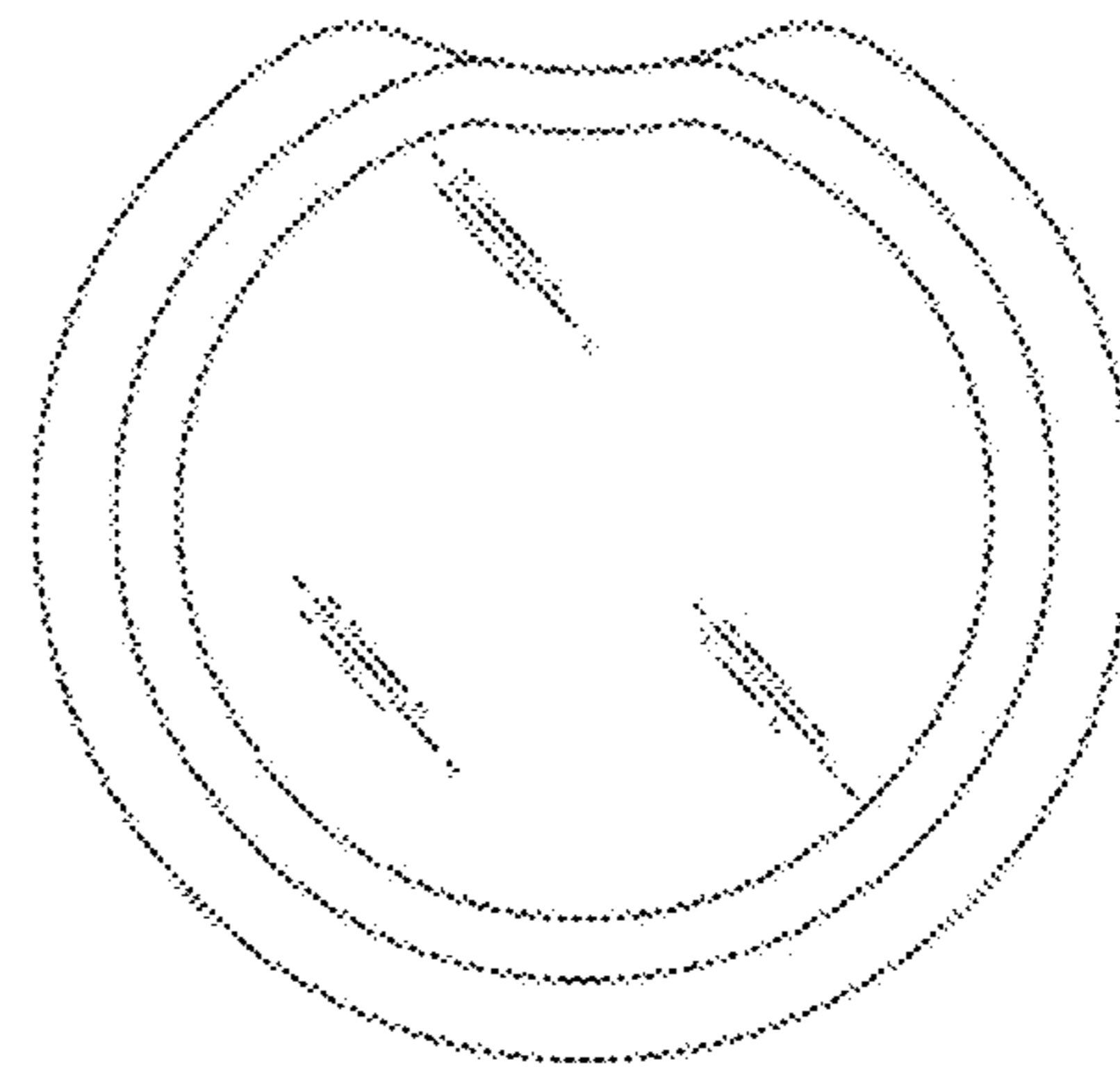

Fig. 94

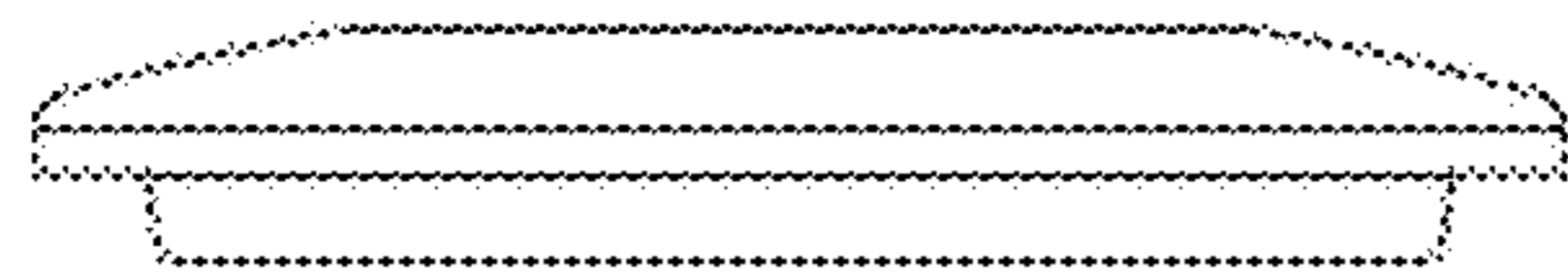

Fig. 95

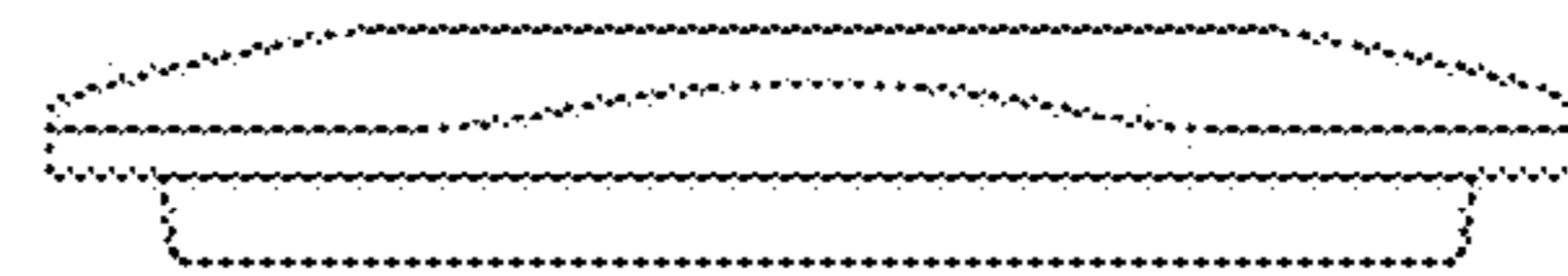
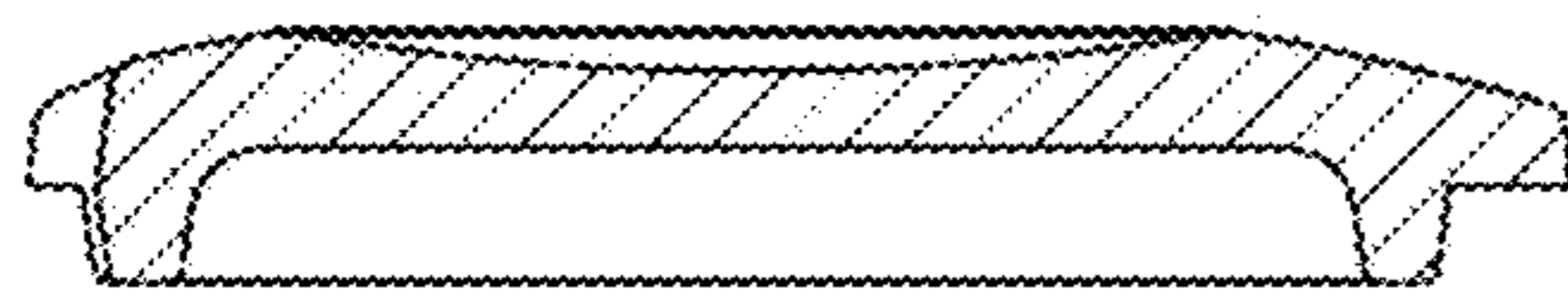

Fig. 96

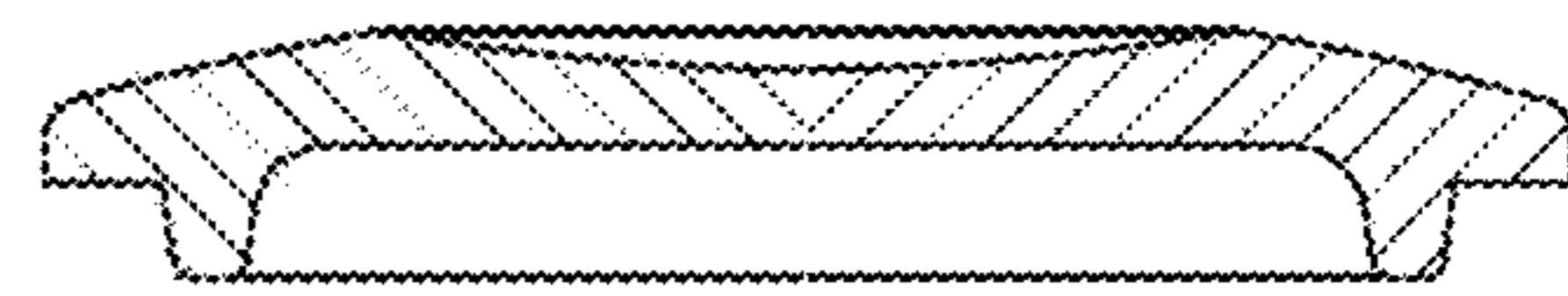

Fig. 97





*Fig. 98*



*Fig. 99*

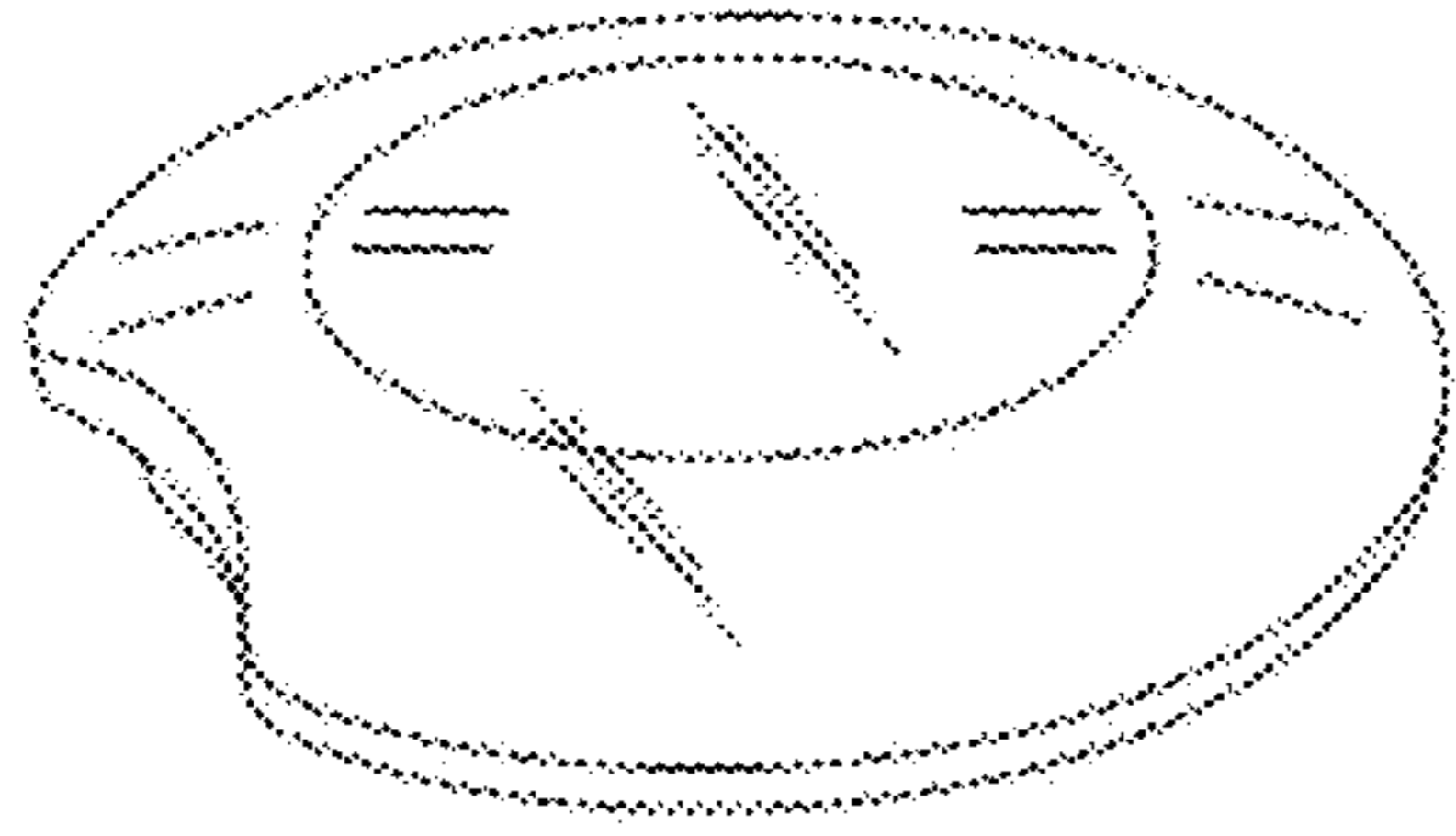

Fig. 100

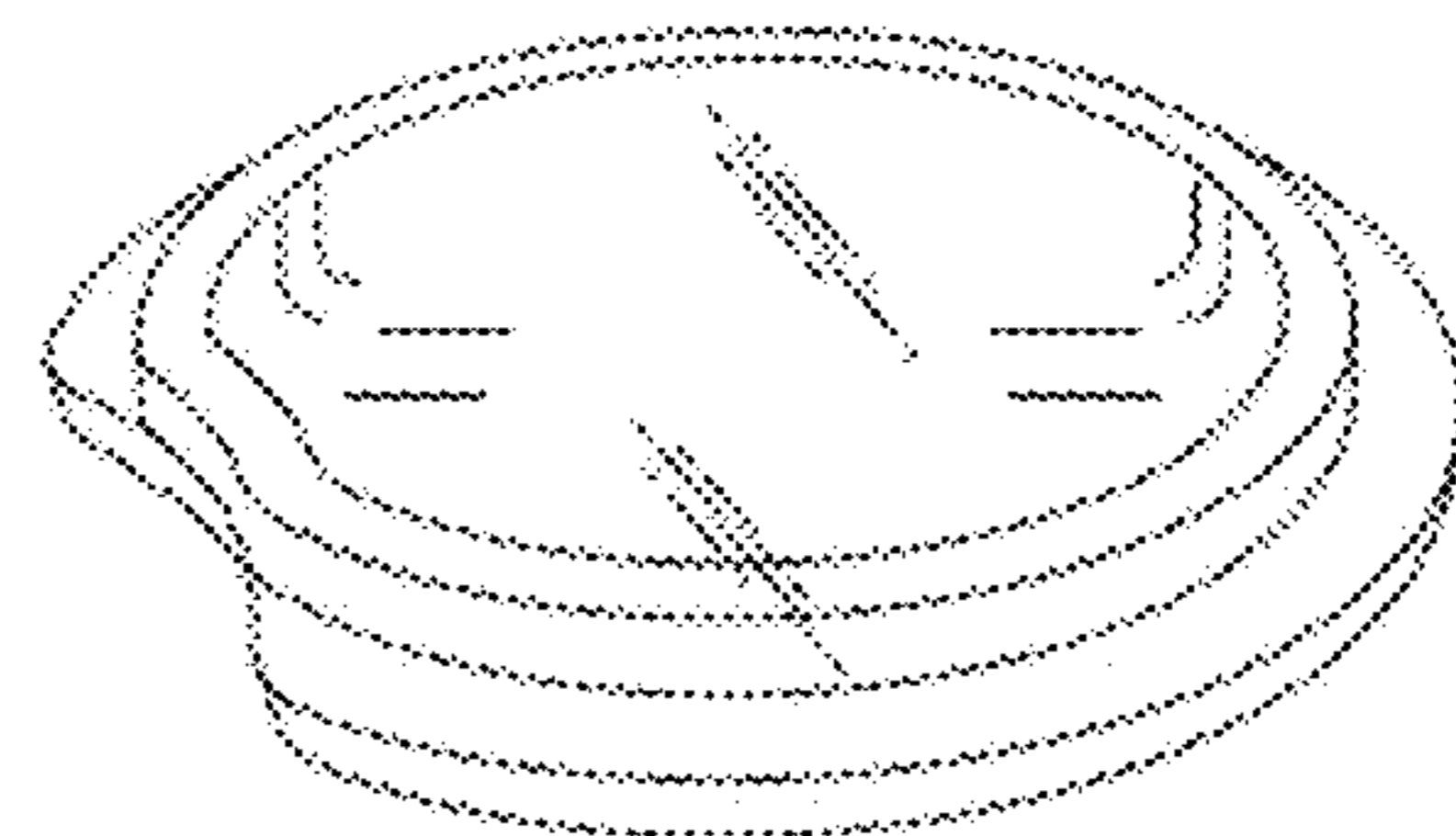

Fig. 101

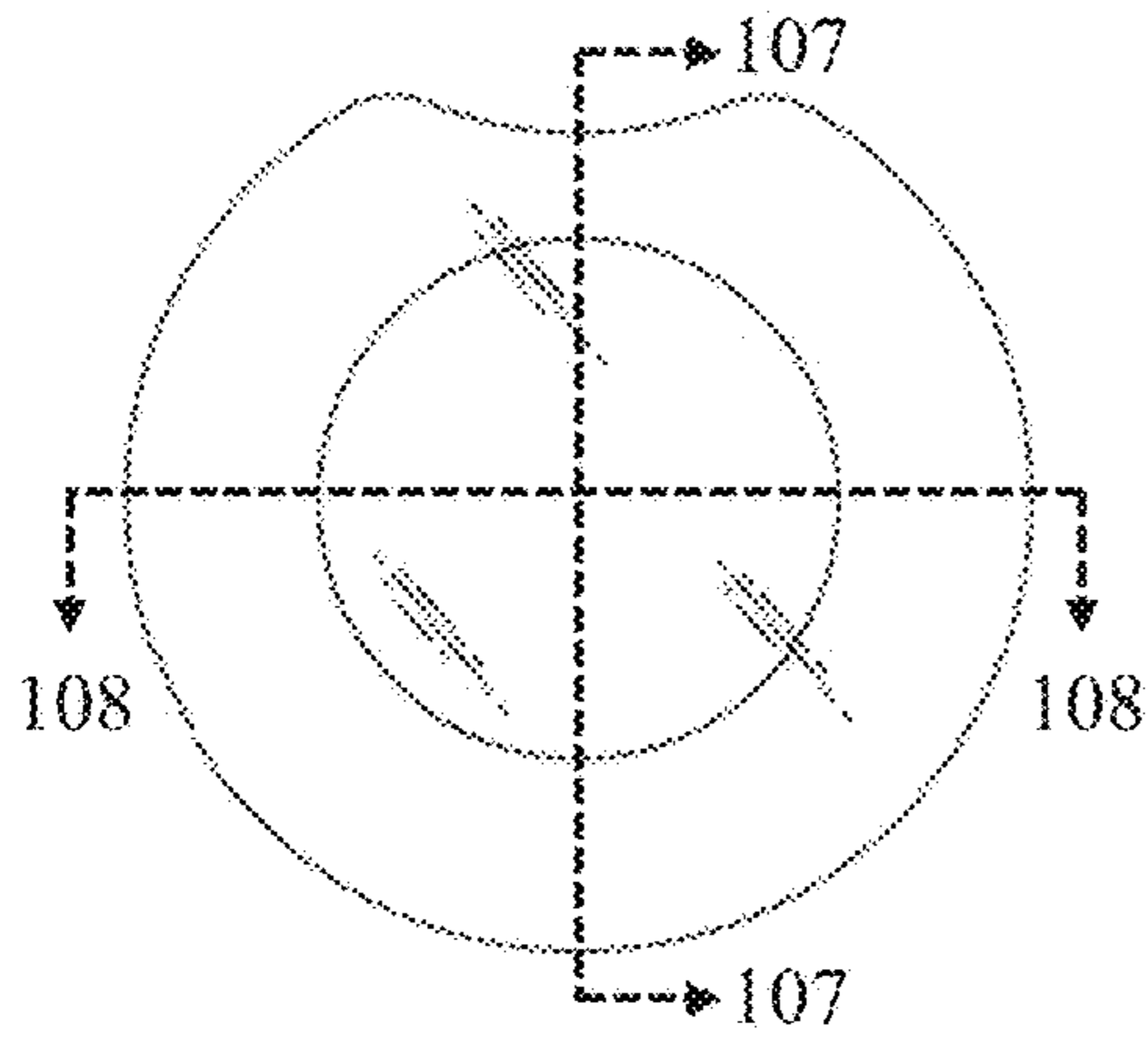

Fig. 102

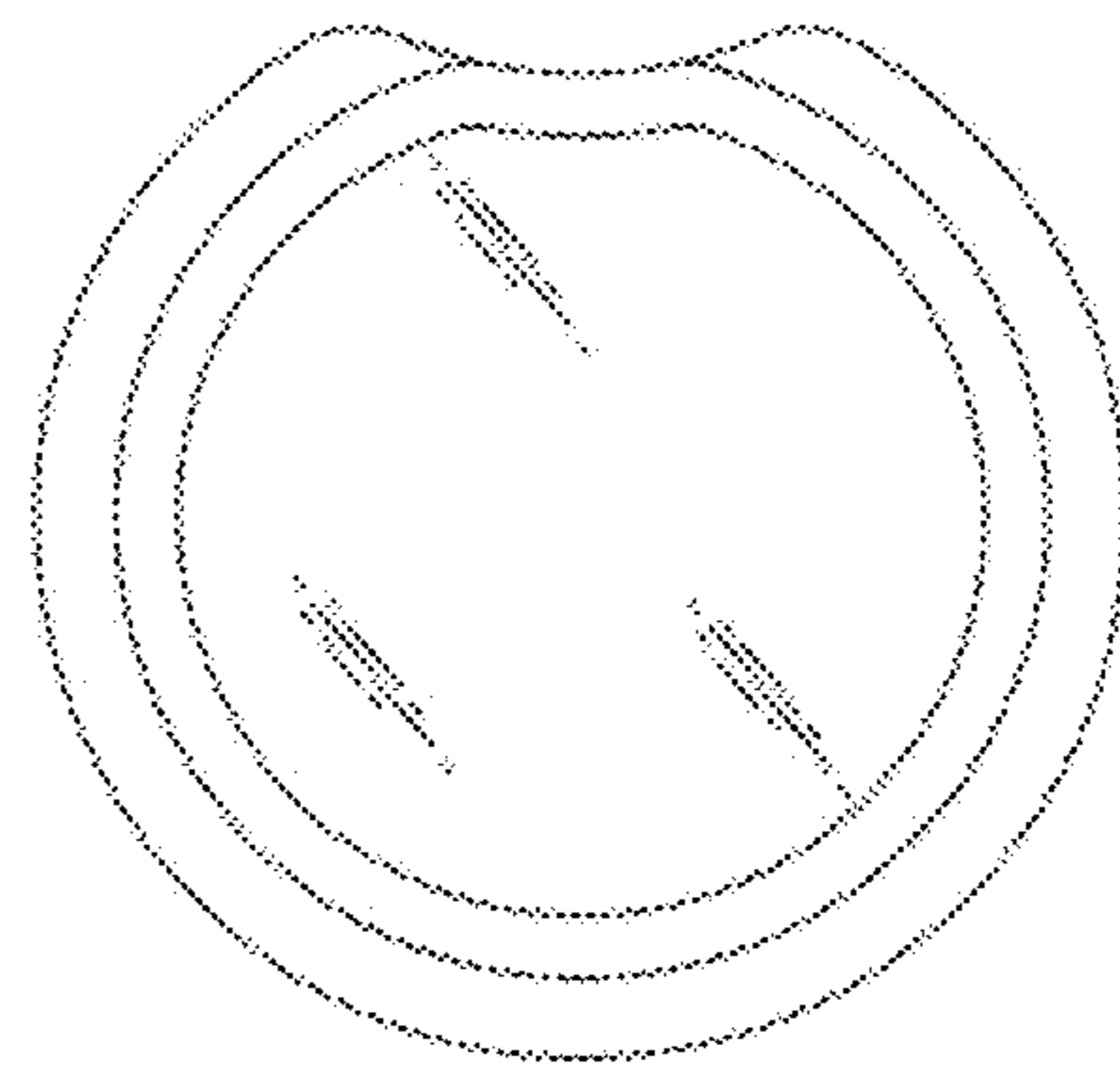

Fig. 103

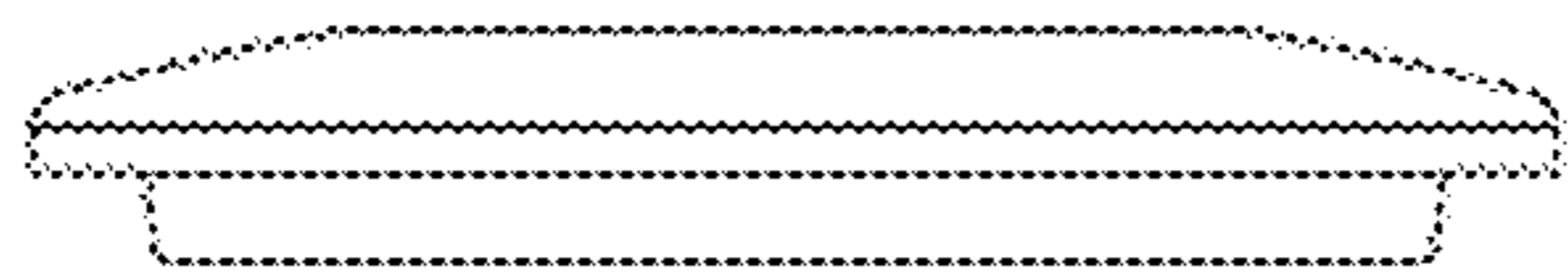

Fig. 104

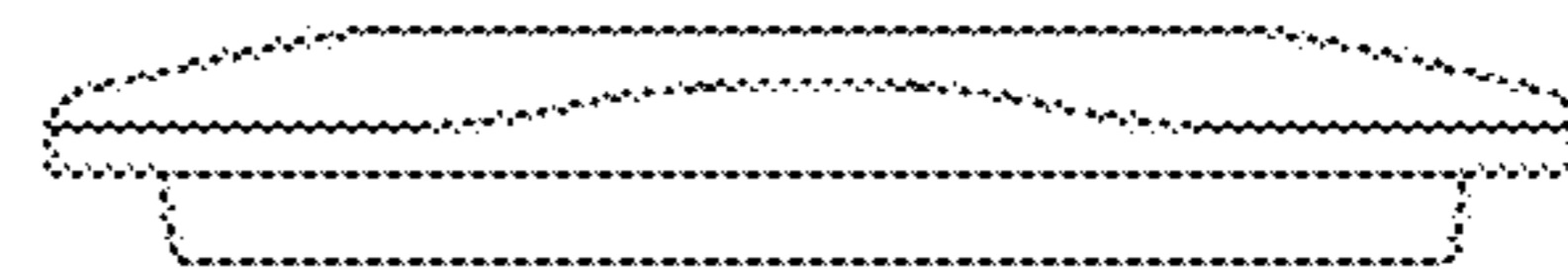

Fig. 105

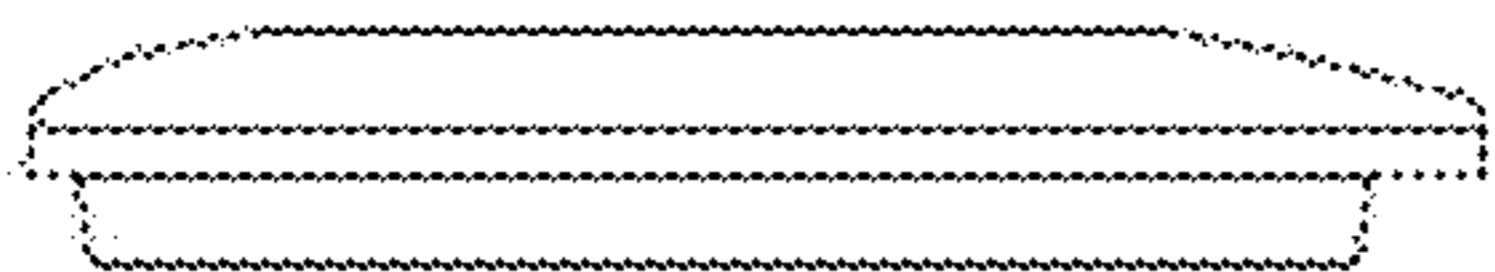
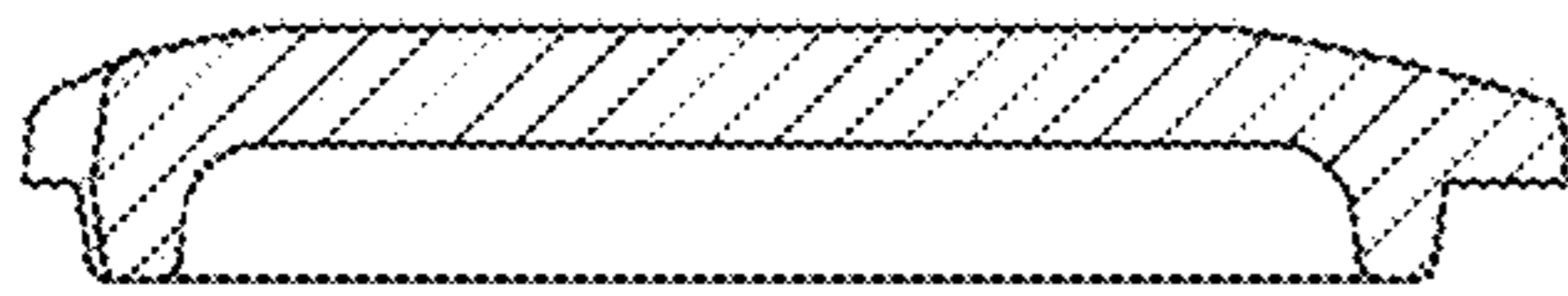
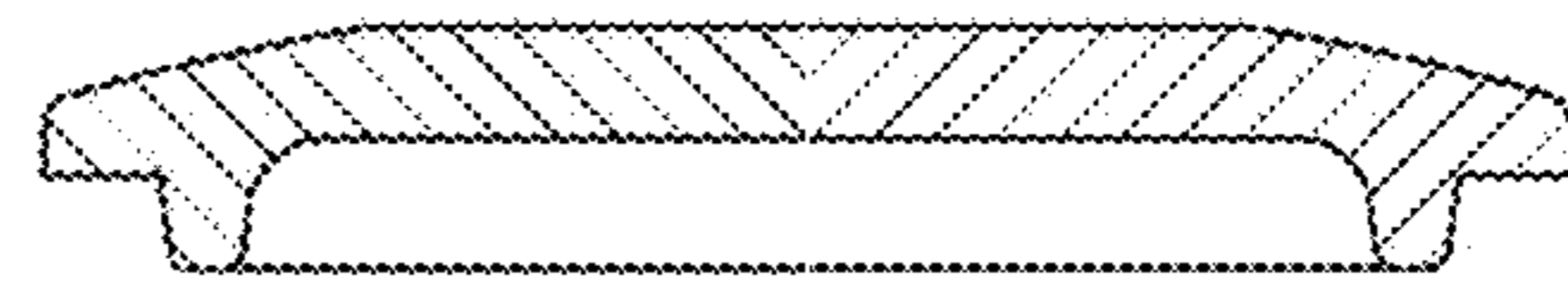

Fig. 106



*Fig. 107*



*Fig. 108*

UNITED STATES PATENT AND TRADEMARK OFFICE  
**CERTIFICATE OF CORRECTION**

PATENT NO. : D833,210 S  
APPLICATION NO. : 29/550850  
DATED : November 13, 2018  
INVENTOR(S) : George Roland Hill

Page 1 of 1

It is certified that error appears in the above-identified patent and that said Letters Patent is hereby corrected as shown below:

On the Title Page

Item (30) Foreign Application Priority Data is missing: please add --Dec. 09, 2015  
(EP).....002901744--

Signed and Sealed this  
Second Day of April, 2019

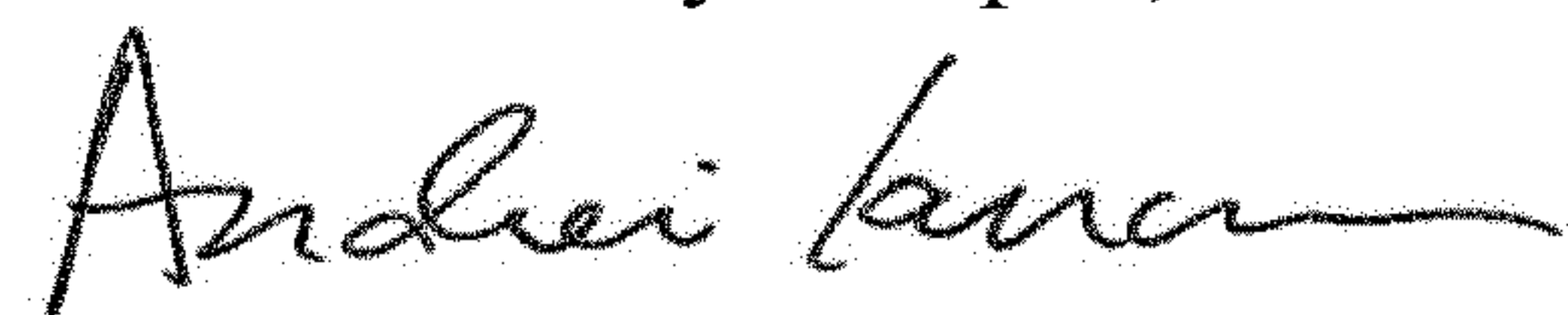

Andrei Iancu  
*Director of the United States Patent and Trademark Office*