



US00D833208S

(12) **United States Design Patent**
Yang et al.

(10) **Patent No.:** **US D833,208 S**

(45) **Date of Patent:** **** Nov. 13, 2018**

(54) **ELECTRIC WARMER**

(71) Applicant: **ETEK CITY CORPORATION**,
Anaheim, CA (US)

(72) Inventors: **Lin Yang**, Shenzhen (CN); **Hai Yang**,
Shenzhen (CN)

(**) Term: **15 Years**

(21) Appl. No.: **29/623,665**

(22) Filed: **Oct. 26, 2017**

(51) **LOC (11) Cl.** **07-02**

(52) **U.S. Cl.**
USPC **D7/363**

(58) **Field of Classification Search**
USPC D7/362-363, 365, 367, 346, 402, 407,
D7/409
CPC ... H05B 3/68; H05B 3/70; H05B 3/72; H05B
3/74; F24C 15/10; F24C 15/102; F24C
15/103; F24C 15/104; F24C 15/105;
F24C 15/106; F24C 15/108; F24C 7/067
See application file for complete search history.

(56) **References Cited**

U.S. PATENT DOCUMENTS

D195,657 S *	7/1963	Sullivan	D7/364
D261,849 S *	11/1981	Funaki	D7/367
D285,523 S *	9/1986	Ayukawa	D7/367
D289,130 S *	4/1987	Rengeji	D7/363
D289,847 S *	5/1987	Okamoto	D7/363
D296,509 S *	7/1988	Fuke	D7/363
D297,701 S *	9/1988	Nakagawa	D7/363
5,072,095 A *	12/1991	Hoffmann	A47J 36/2461 219/432
5,159,178 A *	10/1992	Chen	F24C 15/102 219/451.1
5,317,128 A *	5/1994	Yao	A47J 36/2483 126/25 AA
6,087,637 A *	7/2000	Fischer	H05B 3/74 219/443.1

6,444,958 B1 *	9/2002	Campbell	F24C 15/101 126/21 R
D501,117 S *	1/2005	Bassill	D7/367
D542,790 S *	5/2007	Saruta	D14/363
D553,901 S *	10/2007	Grey	D7/346
D610,394 S *	2/2010	Bodum	D7/362
D643,674 S *	8/2011	Lee	D7/362
D782,869 S *	4/2017	Davenport	D7/402
D790,910 S *	7/2017	Hosoda	D7/362
D791,406 S *	7/2017	Shteysel	D28/9
D793,801 S *	8/2017	Bassill	D7/362

(Continued)

FOREIGN PATENT DOCUMENTS

GB	2218883 A *	11/1989	H05B 3/685
JP	03241236 A *	10/1991		

(Continued)

Primary Examiner — Barbara Fox

Assistant Examiner — Messina L Smith

(74) *Attorney, Agent, or Firm* — Tsz Lung Yeung

(57) **CLAIM**

The ornamental design for an electric warmer, as shown and described.

DESCRIPTION

FIG. 1 is a perspective view of an electric warmer showing my new design;
FIG. 2 is a front view thereof;
FIG. 3 is a rear view thereof;
FIG. 4 is a left end view thereof;
FIG. 5 is a right end view thereof;
FIG. 6 is a top view thereof;
FIG. 7 is a bottom view thereof; and,
FIG. 8 is a rear perspective view thereof.
The broken lines in the drawings depict portions of the electric warmer that form no part of the claimed design.

1 Claim, 8 Drawing Sheets

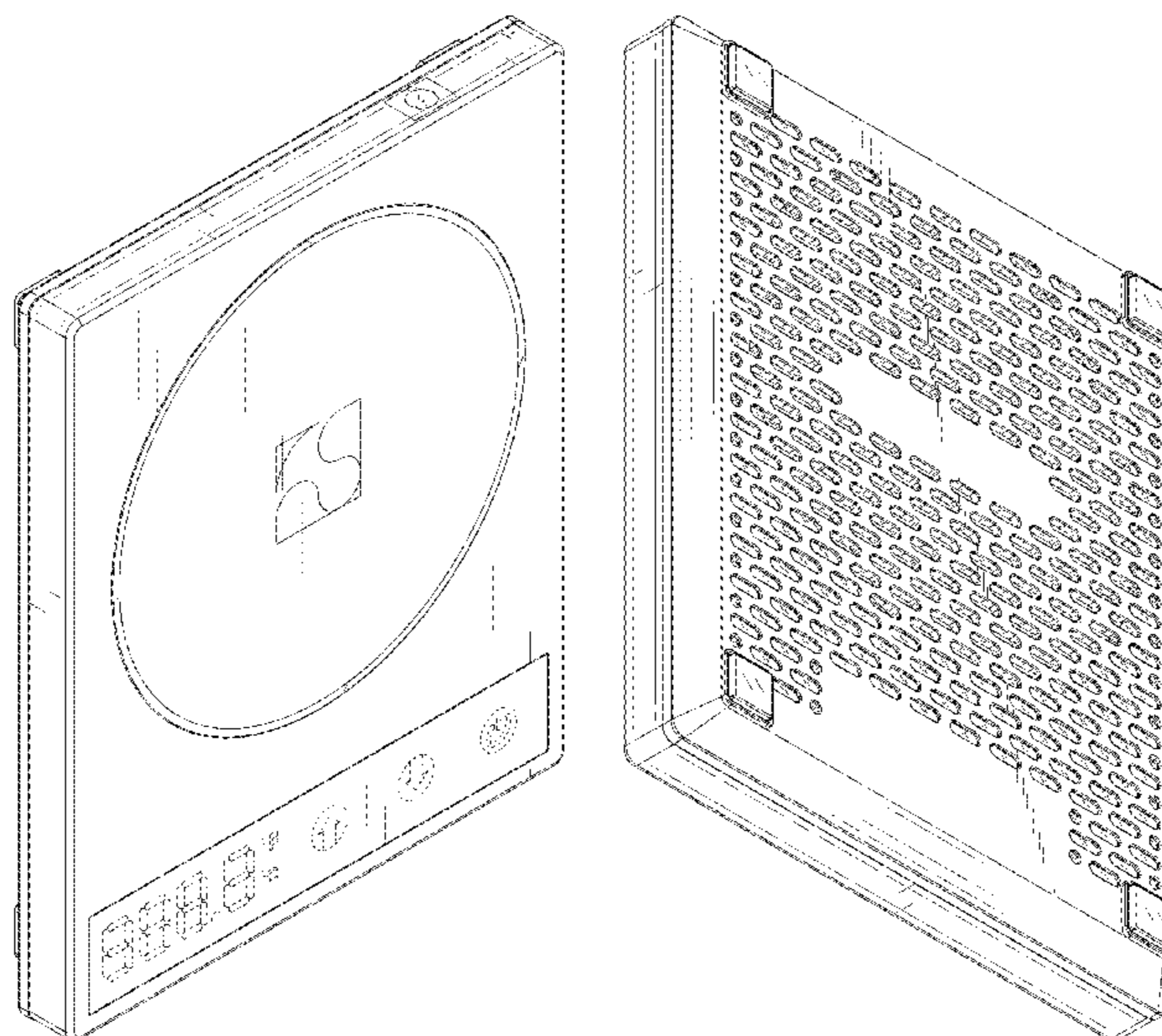

(56)

References Cited

U.S. PATENT DOCUMENTS

D814,848 S * 4/2018 Bassill D7/367
2011/0168696 A1* 7/2011 Huang G06F 1/182
219/660

FOREIGN PATENT DOCUMENTS

JP 10165313 A * 6/1998
JP 2003139329 A * 5/2003 F23D 14/16

* cited by examiner

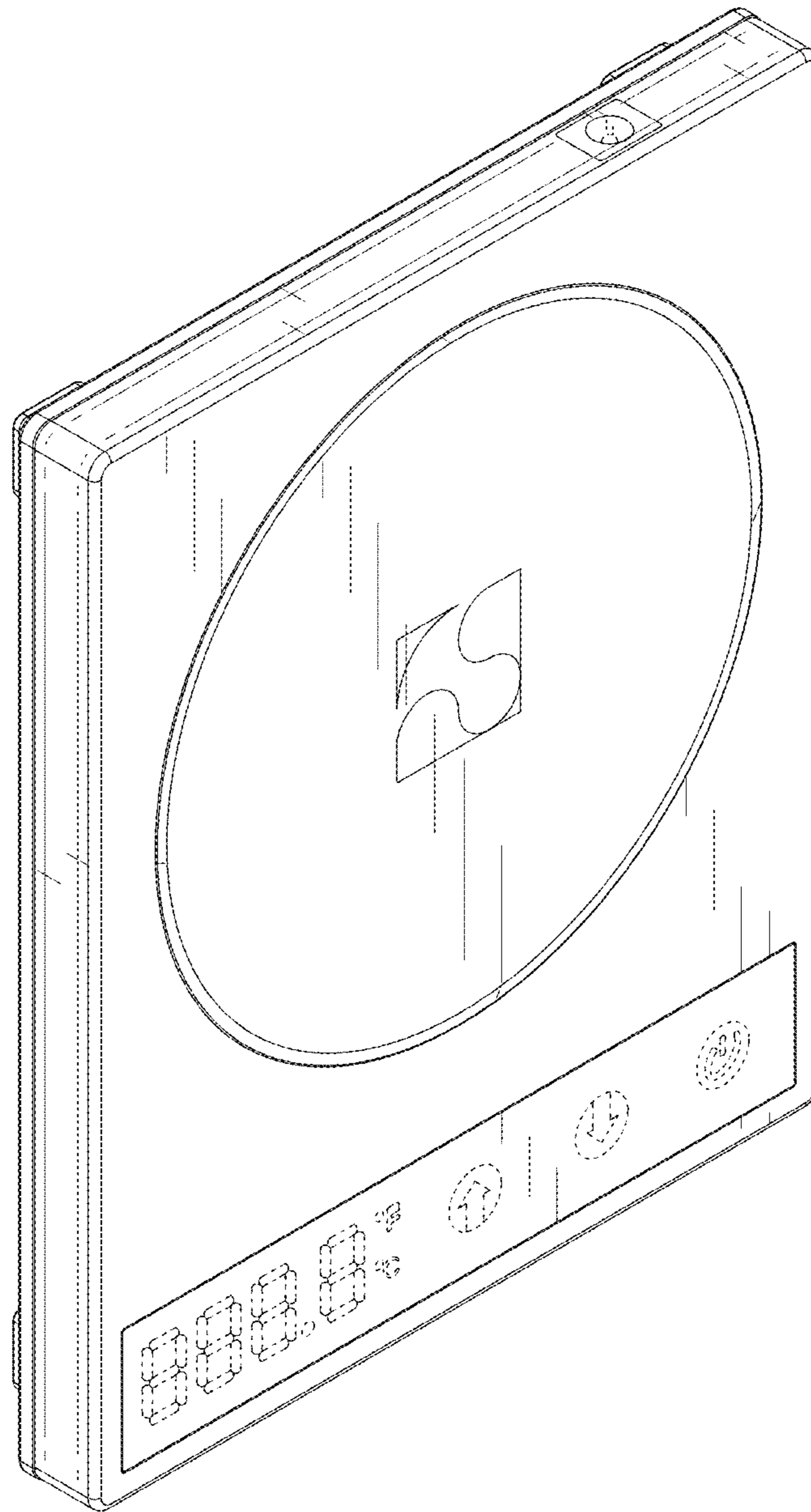

FIG. 1

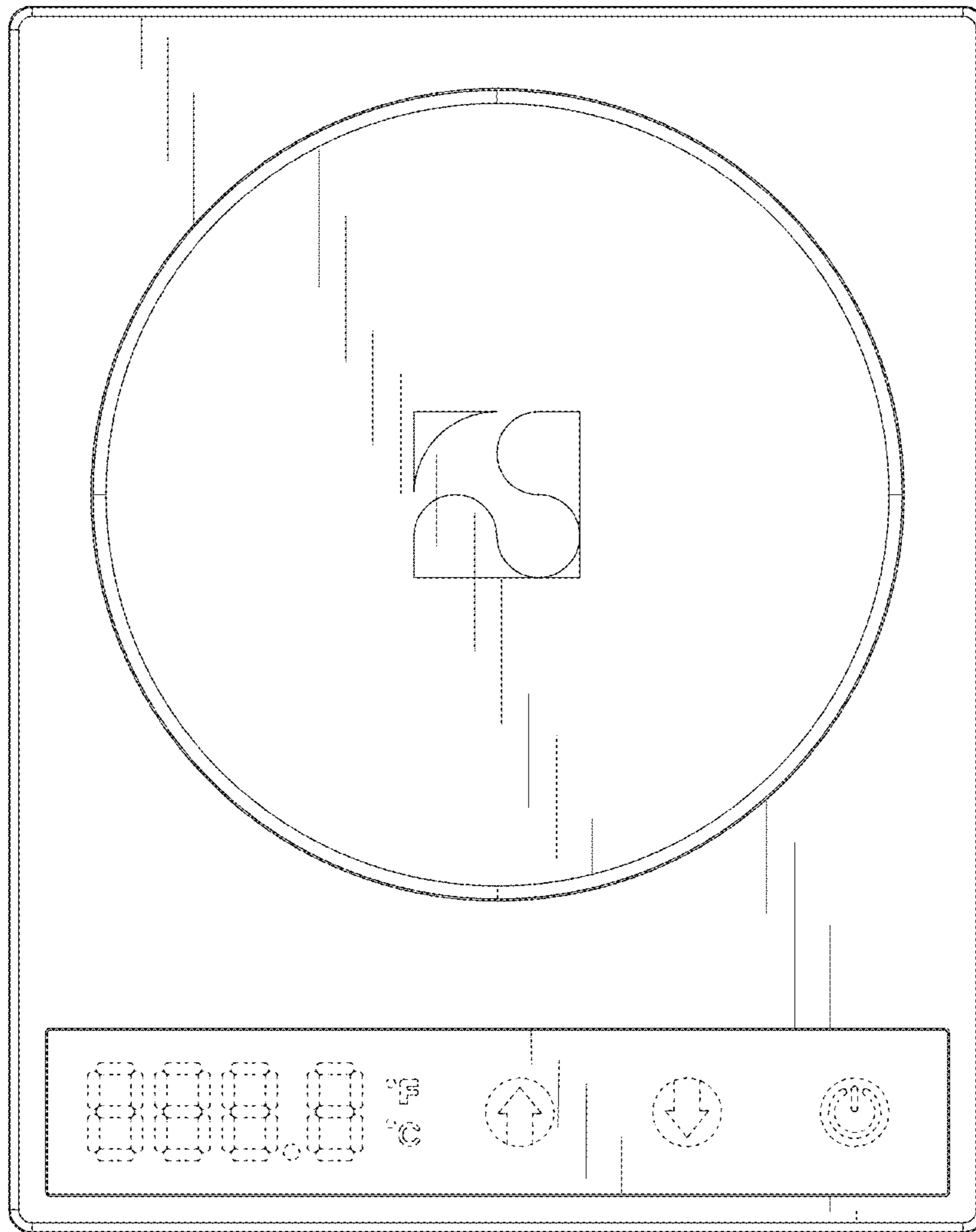

FIG. 2

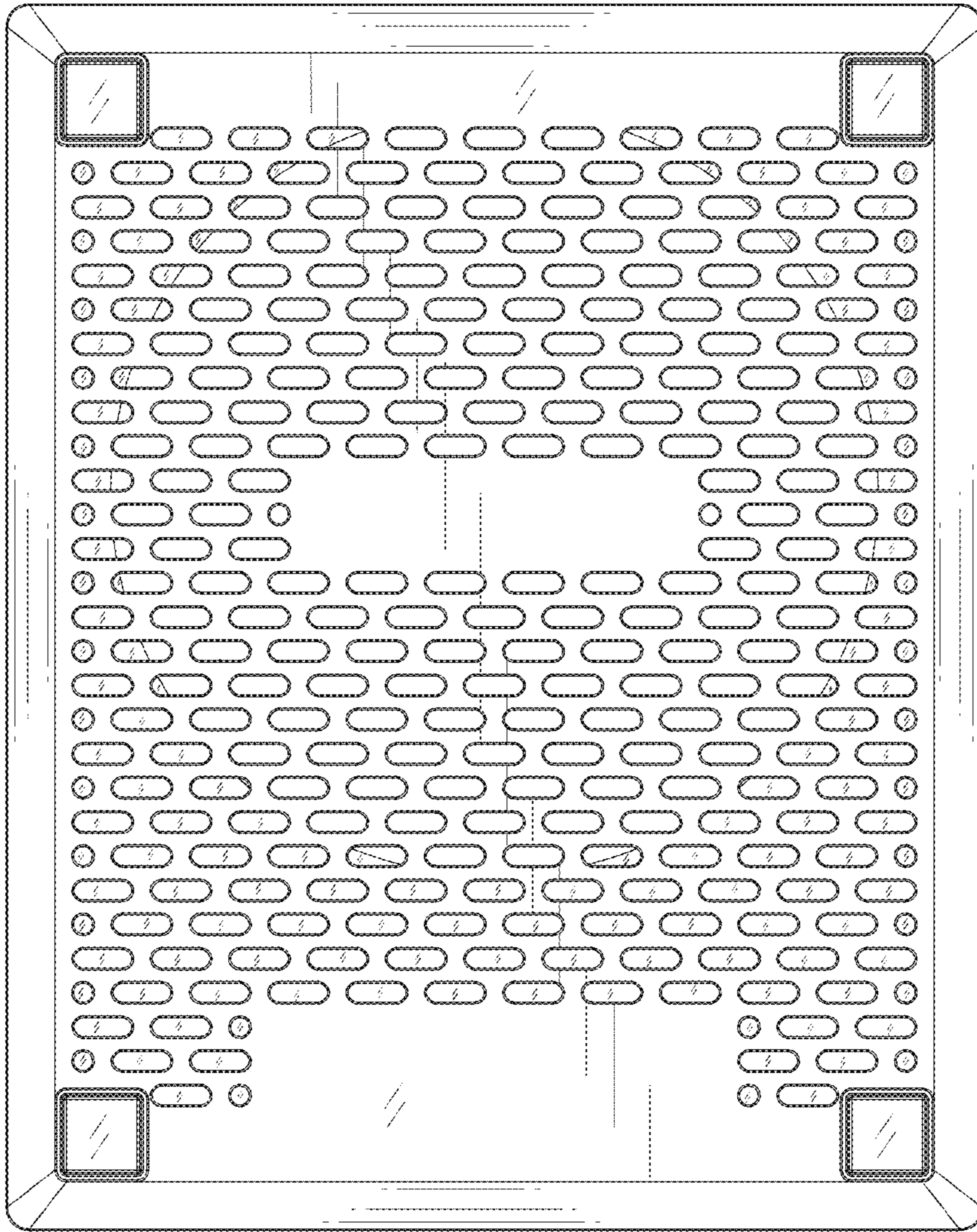

FIG. 3

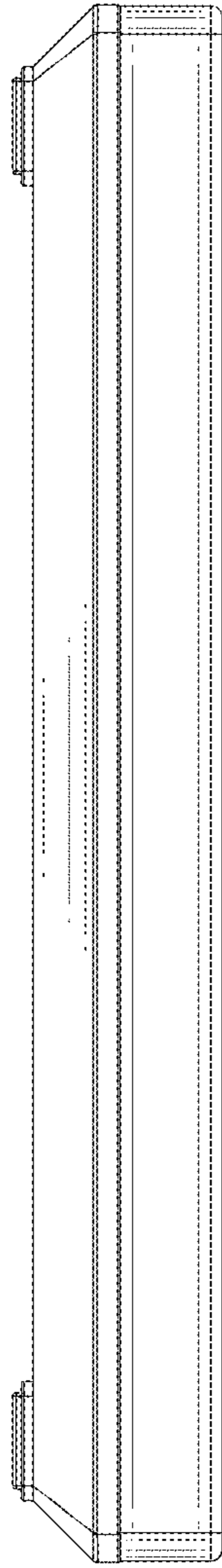

FIG. 4

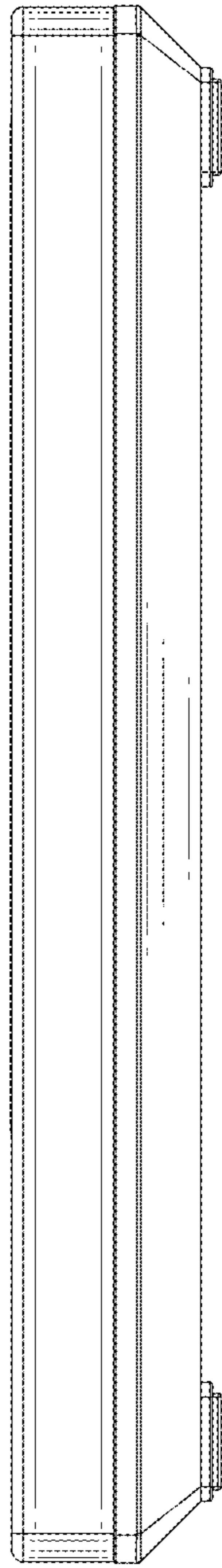

FIG. 5

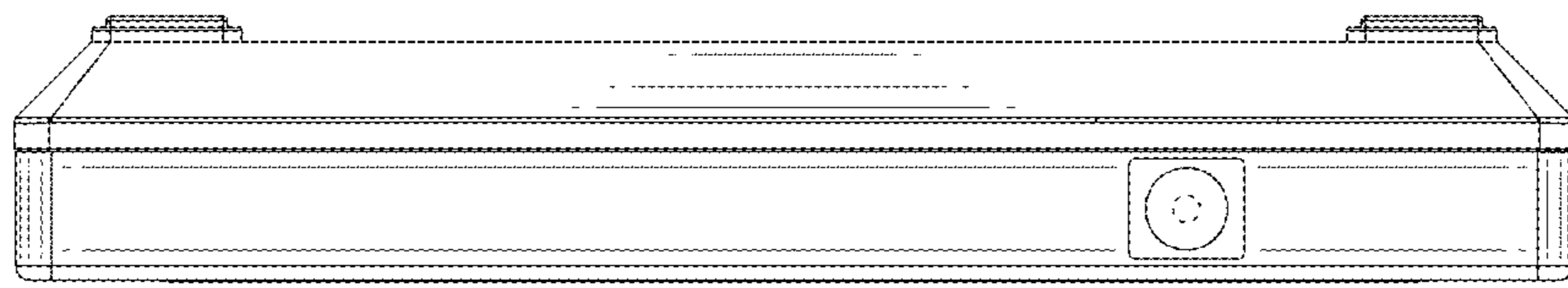

FIG. 6

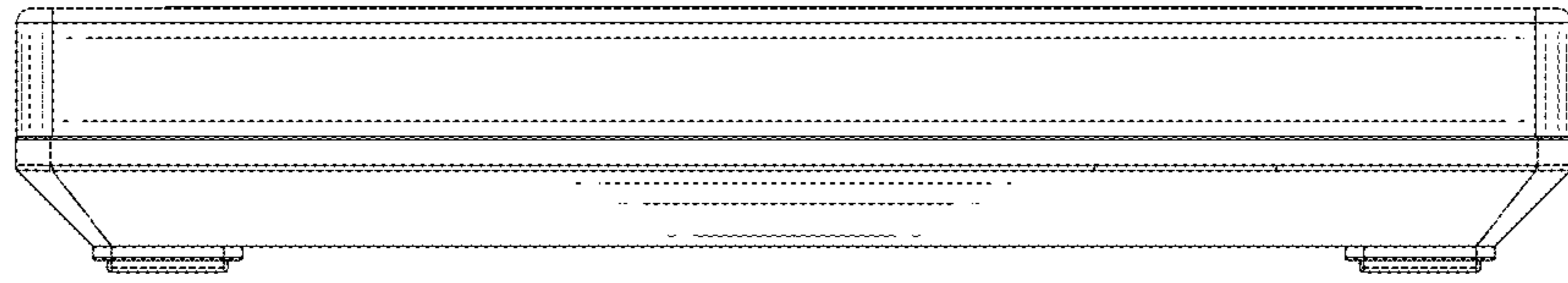

FIG. 7

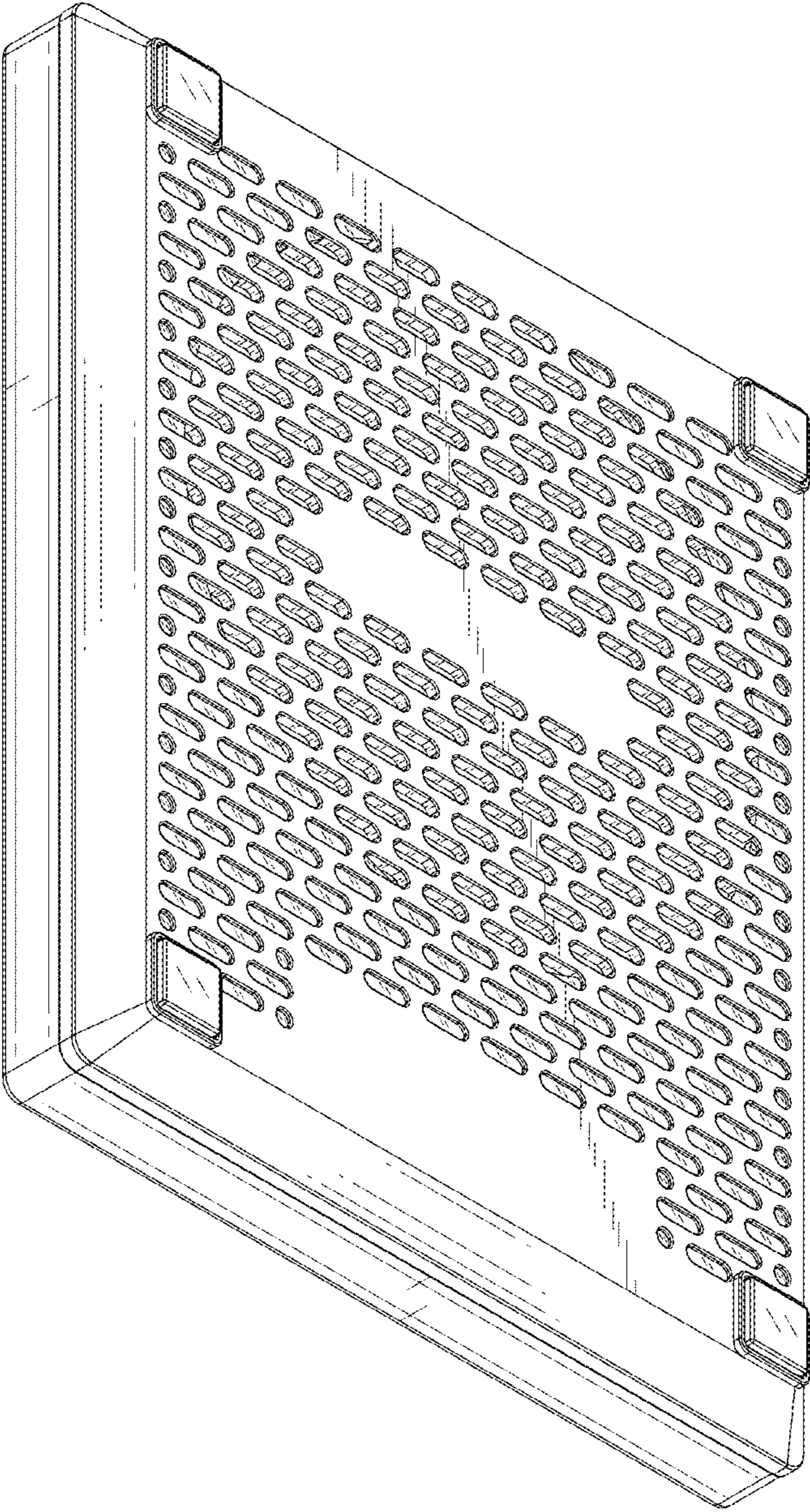

FIG. 8