



US00D833012S

(12) **United States Design Patent** (10) **Patent No.:** **US D833,012 S**
Jones et al. (45) **Date of Patent:** **** Nov. 6, 2018**

(54) **INTERBODY FUSION IMPLANT** D737,446 S * 8/2015 Butler A61F 2/4455
 (71) Applicant: **HD LifeSciences LLC**, Woburn, MA D750,249 S * 2/2016 Grimberg, Jr. D24/155
 (US) D789,539 S * 6/2017 Kleiner D24/155
 D816,844 S * 5/2018 Ricca D24/155

(72) Inventors: **Christopher L. Jones**, Malden, MA (US); **Ian Helmar**, Beverly, MA (US);
Lucas Diehl, Beverly, MA (US); **Jason Tinley**, Fort Worth, TX (US); **Kevin D. Chappuis**, Malden, MA (US); **John F. Sullivan**, Pelham, NH (US) * cited by examiner
Primary Examiner — Charles D Hanson
 (74) *Attorney, Agent, or Firm* — Law Offices of Daniel A. Tesler, LLC

(73) Assignee: **HD LifeSciences LLC**, Woburn, MA (US)

(**) Term: **15 Years**

(21) Appl. No.: **29/613,157**

(22) Filed: **Aug. 8, 2017**

(51) **LOC (11) Cl.** **24-03**

(52) **U.S. Cl.**
 USPC **D24/155**

(58) **Field of Classification Search**
 USPC D24/155
 CPC A61F 2/4611; A61F 2/442; A61F 2/447;
 A61F 2220/0025; A61F 2310/00023;
 A61F 2310/00017; A61F 2002/4475;
 A61F 2002/30841; A61F 2002/2835;
 A61F 2002/30904; A61F 2002/30785;
 A61F 2002/443; A61F 2002/30578
 See application file for complete search history.

(56) **References Cited**

U.S. PATENT DOCUMENTS

D626,233 S * 10/2010 Cipoletti A61F 2/447
 D24/155
 D653,757 S * 2/2012 Binder A61F 2/446
 D24/155

(57) **CLAIM**

The ornamental design for an interbody fusion implant, as shown and described.

DESCRIPTION

FIG. 1 is a perspective view showing the rear, top and right sides of the interbody fusion implant, showing my new design;
 FIG. 2 is an enlarged portion of a perspective view taken from the FIG. 1 perspective view thereof;
 FIG. 3 is a perspective view showing the front, top and right sides thereof;
 FIG. 4 is an enlarged portion of a perspective view taken from the FIG. 3 perspective view thereof;
 FIG. 5 is a right side view thereof;
 FIG. 6 is a left side view thereof;
 FIG. 7 is a top plan view thereof;
 FIG. 8 is a bottom plan view thereof;
 FIG. 9 is a rear view thereof; and,
 FIG. 10 is a front view thereof.

The broken line portions are included to show unclaimed subject matter only and form no part of the claimed design.

1 Claim, 6 Drawing Sheets

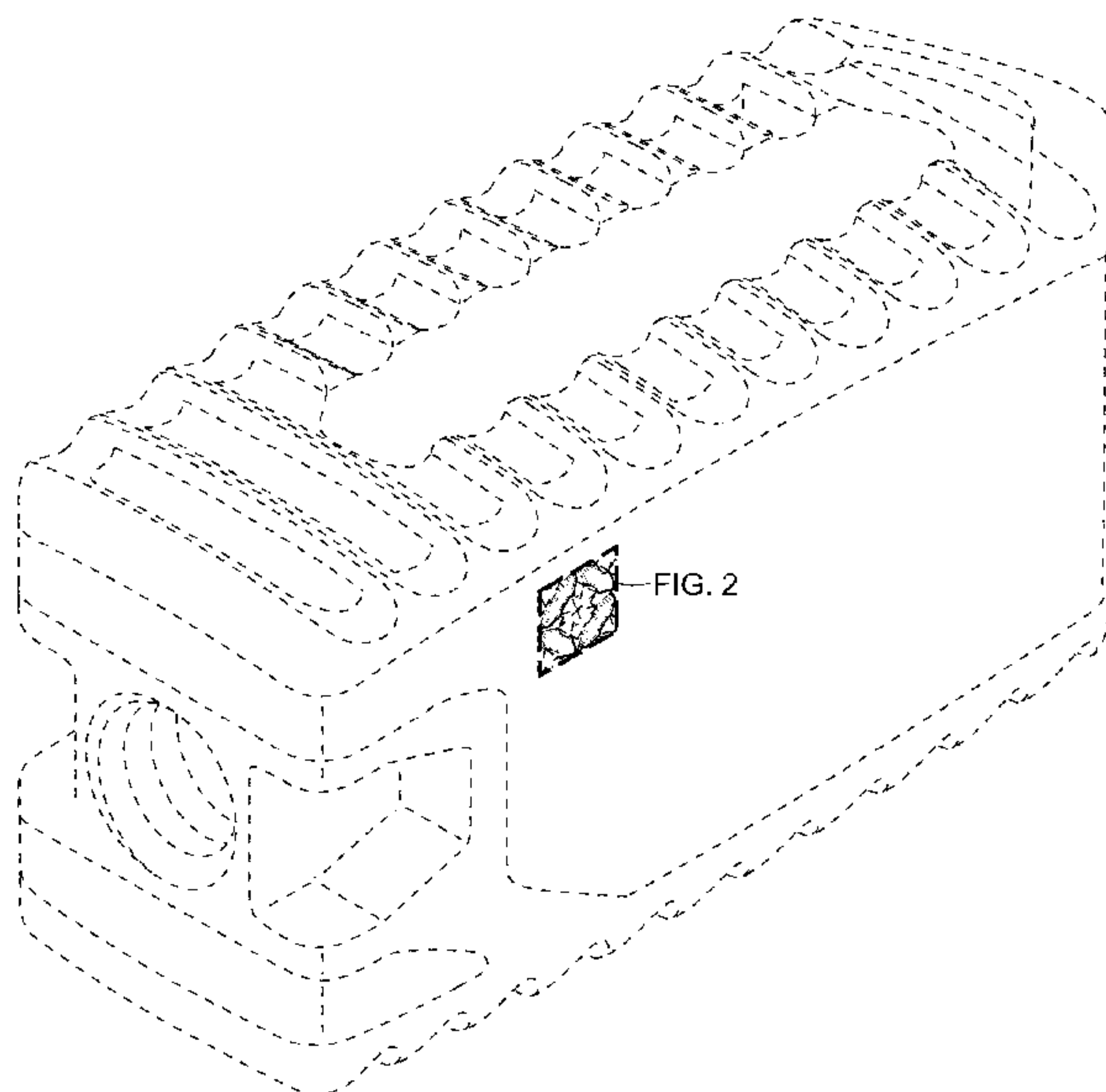

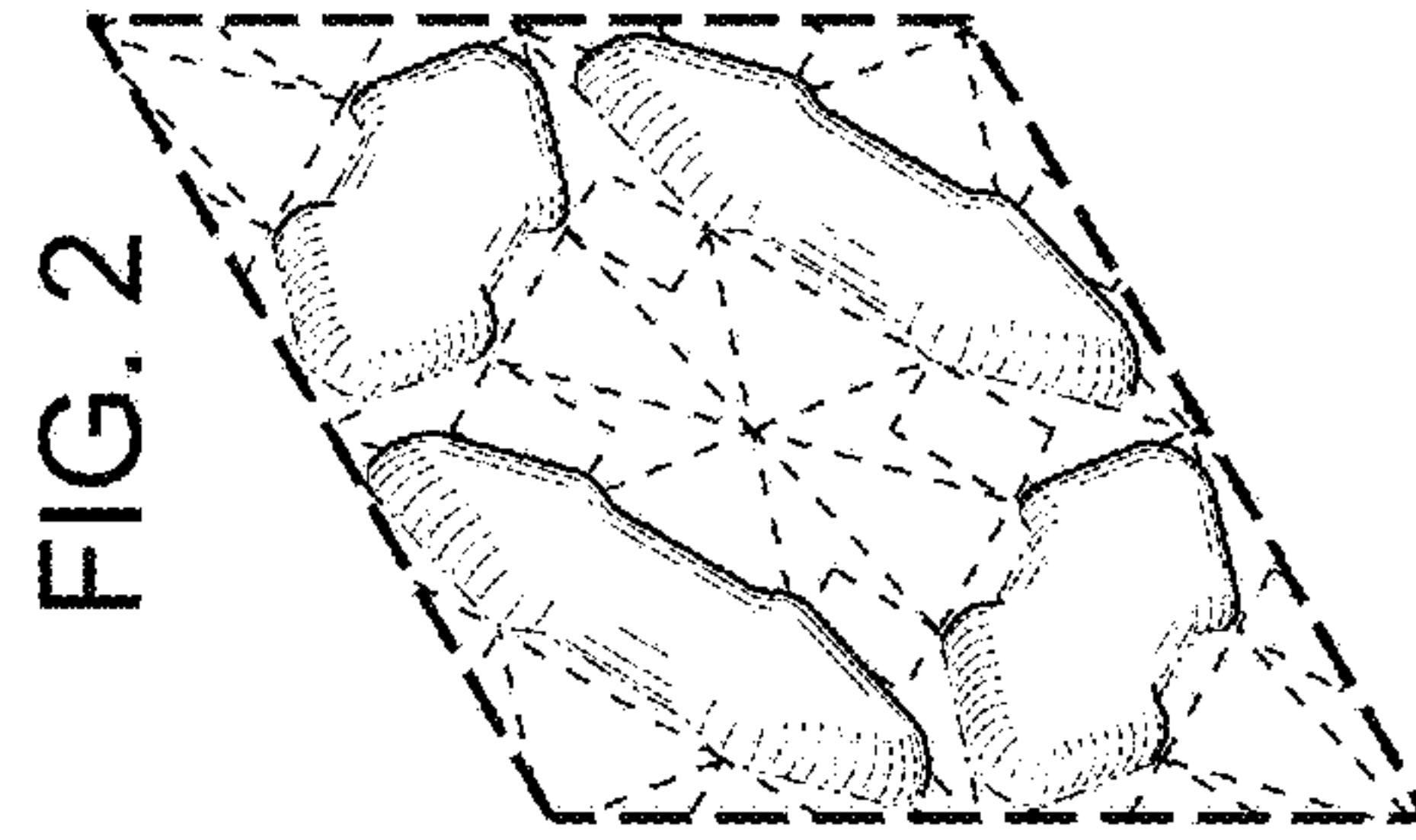
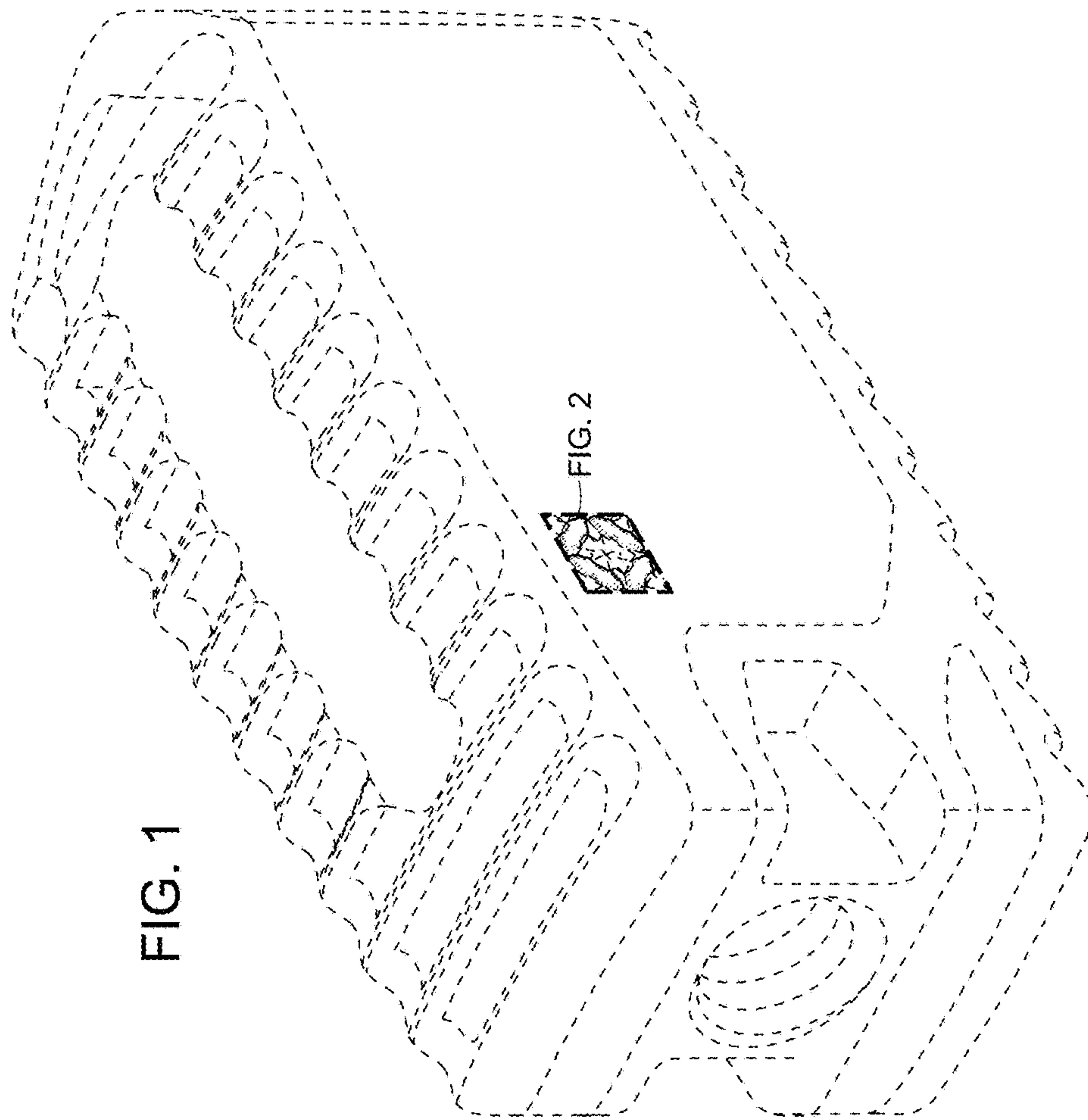

FIG. 4

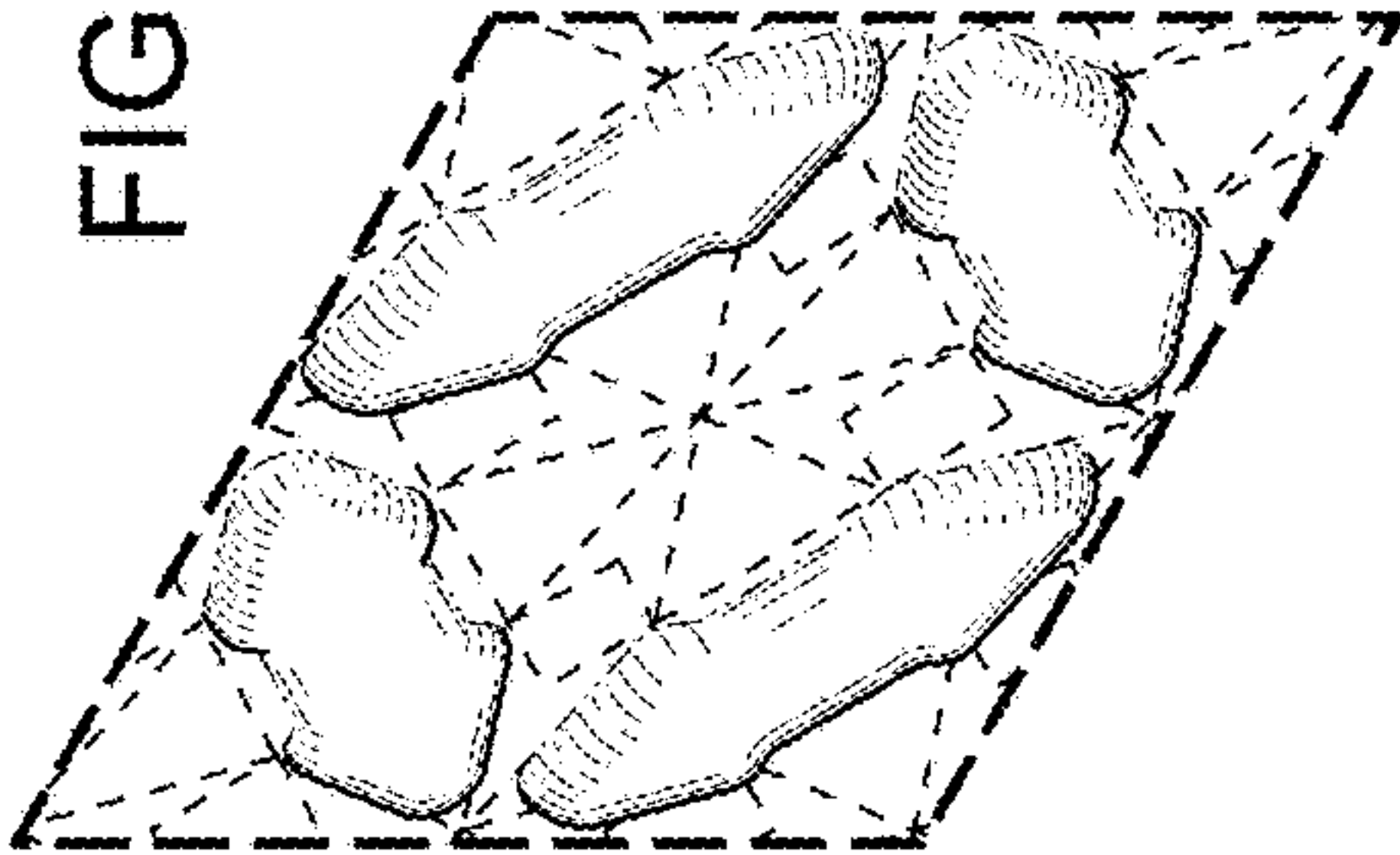
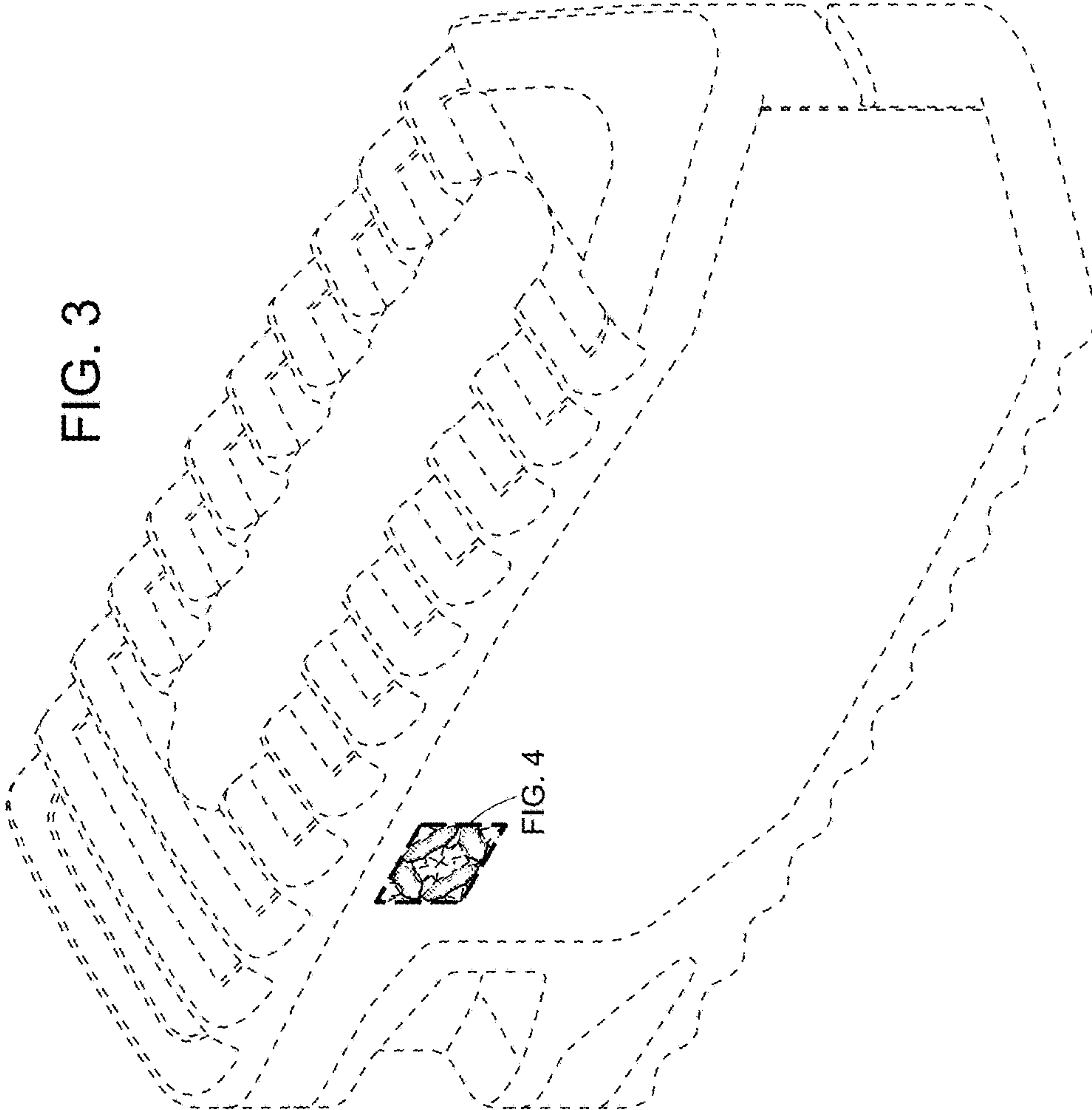

FIG. 3



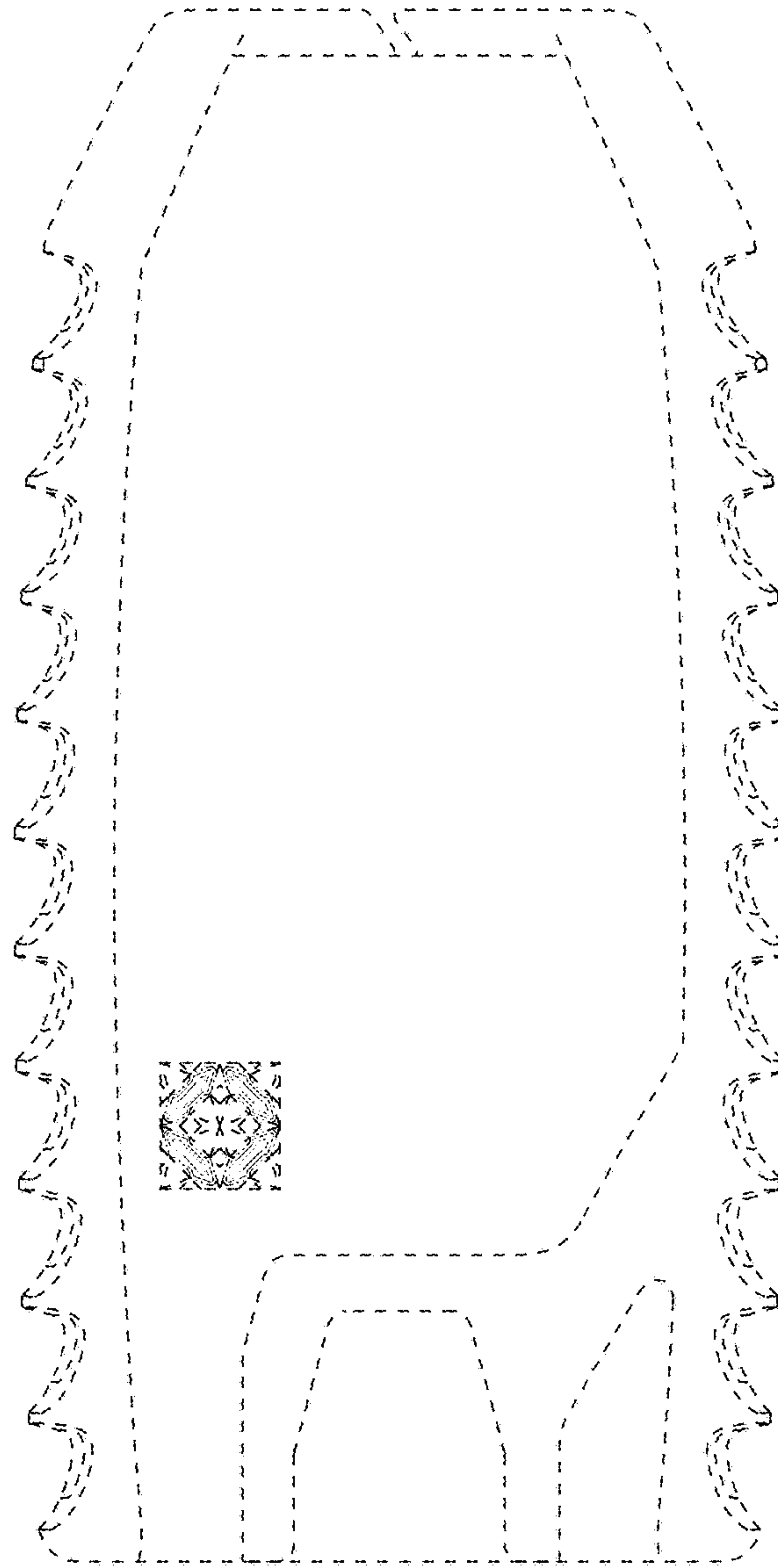

FIG. 5

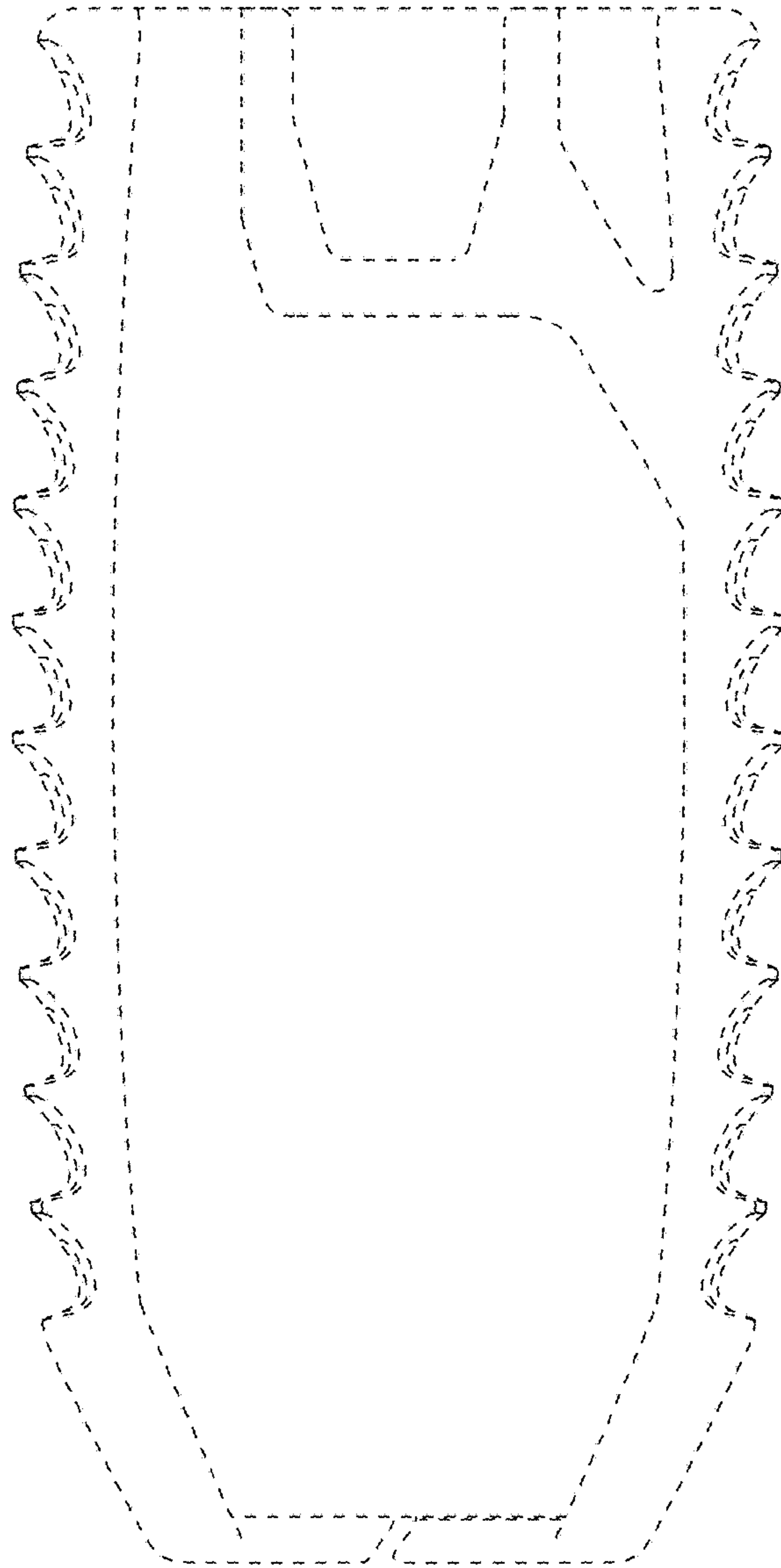

FIG. 6

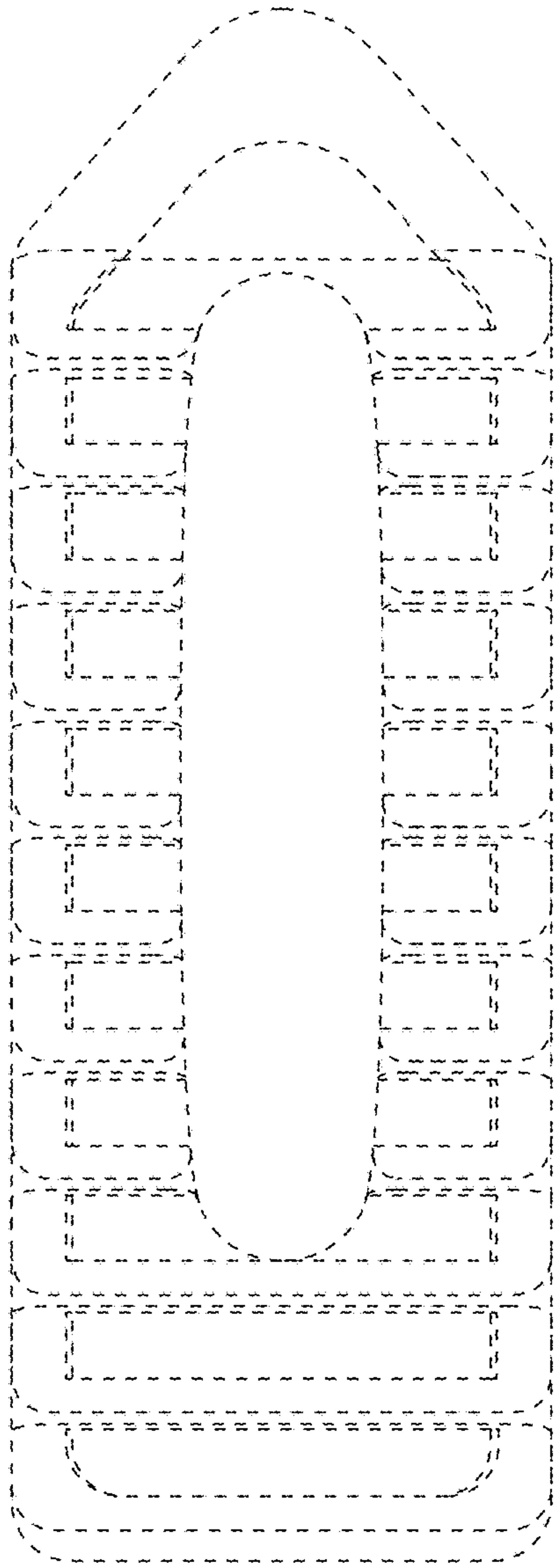

FIG. 7

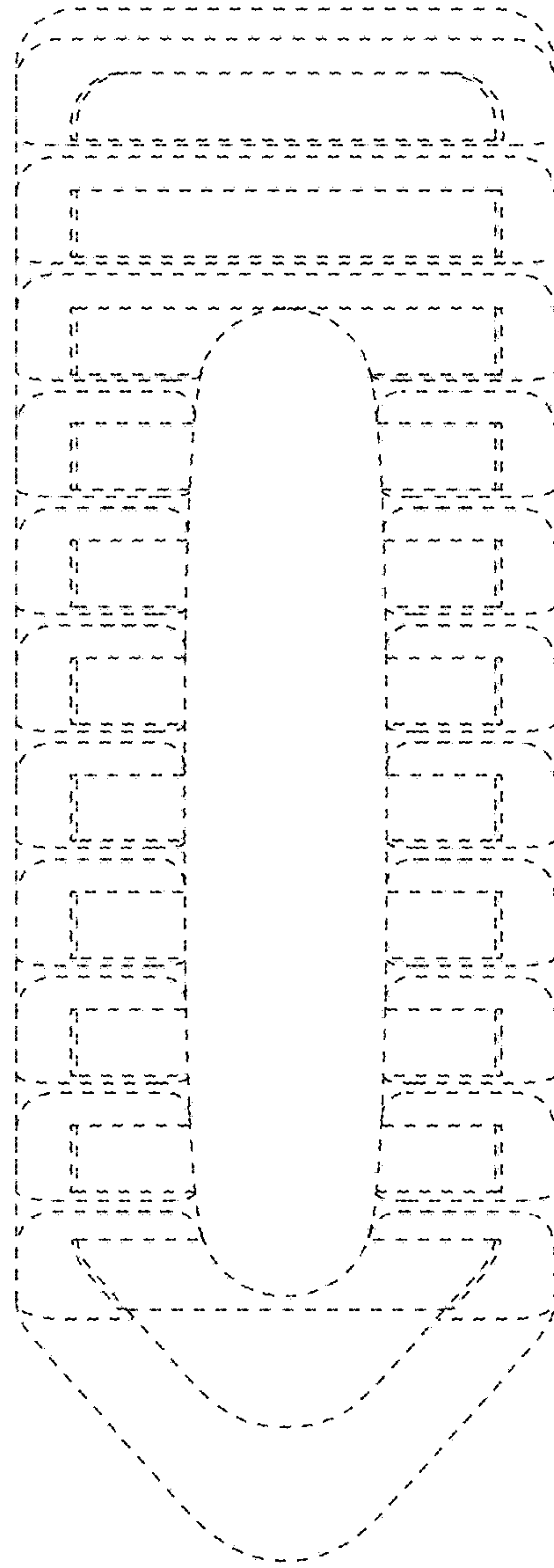

FIG. 8

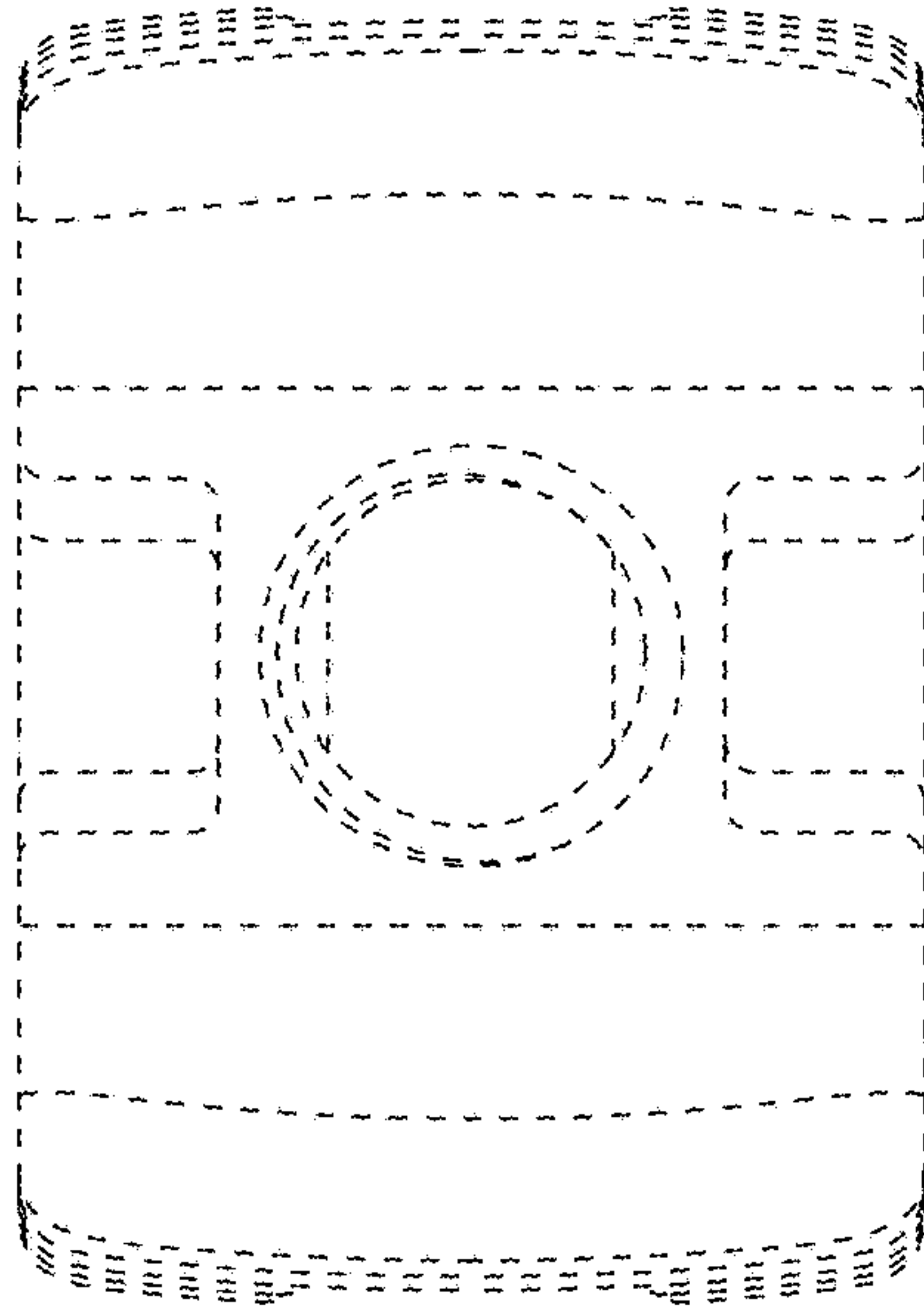

FIG. 9

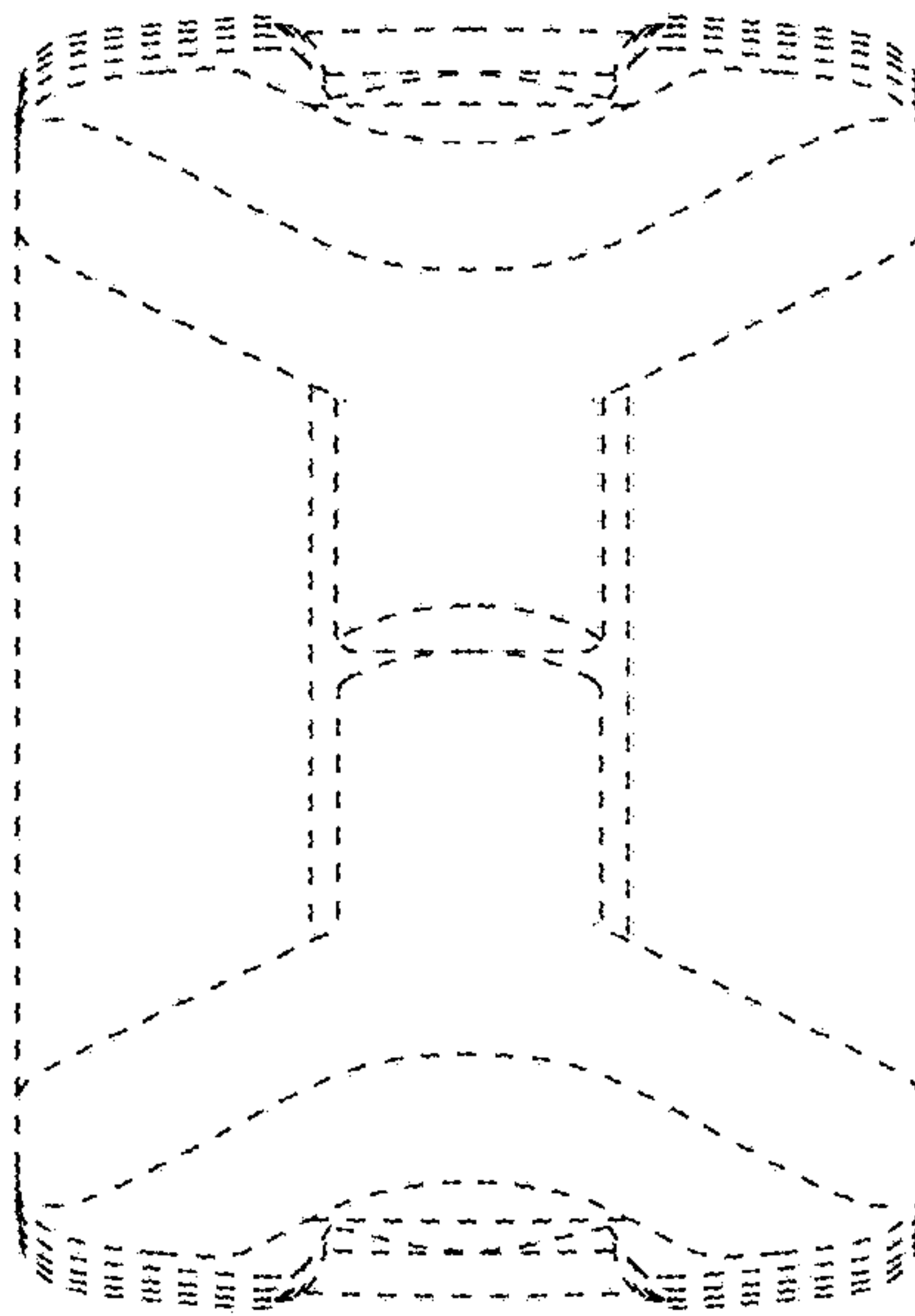

FIG. 10