



US00D832974S

(12) **United States Design Patent** (10) **Patent No.:** **US D832,974 S**  
**Müller** (45) **Date of Patent:** **\*\* \*Nov. 6, 2018**

(54) **TOILET RIM BLOCK**

(71) Applicant: **TOMIL S.R.O.**, Vysoké Myto (CZ)

(72) Inventor: **Tomas Müller**, Hradec Kralove (CZ)

(73) Assignee: **TOMIL s.r.o.**, Vysoké Myto (CZ)

(\*) Notice: This patent is subject to a terminal disclaimer.

(\*\*) Term: **15 Years**

(21) Appl. No.: **35/502,120**

(22) Filed: **Sep. 5, 2016**

(80) **Hague Agreement Data**

Int. Filing Date: **Sep. 5, 2016**

Int. Reg. No.: **DM/093753**

Int. Reg. Date: **Sep. 5, 2016**

Int. Reg. Pub. Date: **Dec. 16, 2016**

(30) **Foreign Application Priority Data**

Mar. 8, 2016 (EP) ..... 003019140

(51) **LOC (11) Cl.** ..... **23-01**

(52) **U.S. Cl.**  
USPC ..... **D23/208; D23/368**

(58) **Field of Classification Search**  
USPC ..... **D23/207, 208, 366**

(Continued)

(56) **References Cited**

**U.S. PATENT DOCUMENTS**

D655,778 S \* 3/2012 Muhlhausen ..... D23/208

D656,575 S \* 3/2012 Muhlhausen ..... D23/208

(Continued)

*Primary Examiner* — Keli L Hill

(74) *Attorney, Agent, or Firm* — The Webb Law Firm

(57) **CLAIM**

The ornamental design for toilet rim block, as shown and described.

**DESCRIPTION**

The file of this patent contains at least one drawing/photograph executed in color. Copies of this patent with color drawings/photographs will be provided by the Office upon request and payment of the necessary fee.

1.1 is a front elevation view of toilet rim block, showing my new design in accordance with an embodiment of the present invention;

1.2 is a rear elevation view thereof;

1.3 is a right side elevation view thereof;

1.4 is a left side elevation view thereof;

1.5 is a top plan view thereof;

1.6 is a bottom plan view thereof;

1.7 is a front, right perspective view thereof;

2.1 is a front elevation view of toilet rim block, showing my new design in accordance with an embodiment of the present invention;

2.2 is a rear elevation view thereof;

2.3 is a right side elevation view thereof;

2.4 is a left side elevation view thereof;

2.5 is a top plan view thereof;

2.6 is a bottom plan view thereof;

2.7 is a front, right perspective view thereof;

3.1 is a front elevation view of toilet rim block, showing my new design in accordance with an embodiment of the present invention;

3.2 is a rear elevation view thereof;

3.3 is a right side elevation view thereof;

3.4 is a left side elevation view thereof;

3.5 is a top plan view thereof;

3.6 is a bottom plan view thereof;

3.7 is a front, right perspective view thereof;

4.1 is a front elevation view of toilet rim block, showing my new design in accordance with an embodiment of the present invention;

4.2 is a rear elevation view thereof;

4.3 is a right side elevation view thereof;

4.4 is a left side elevation view thereof;

(Continued)

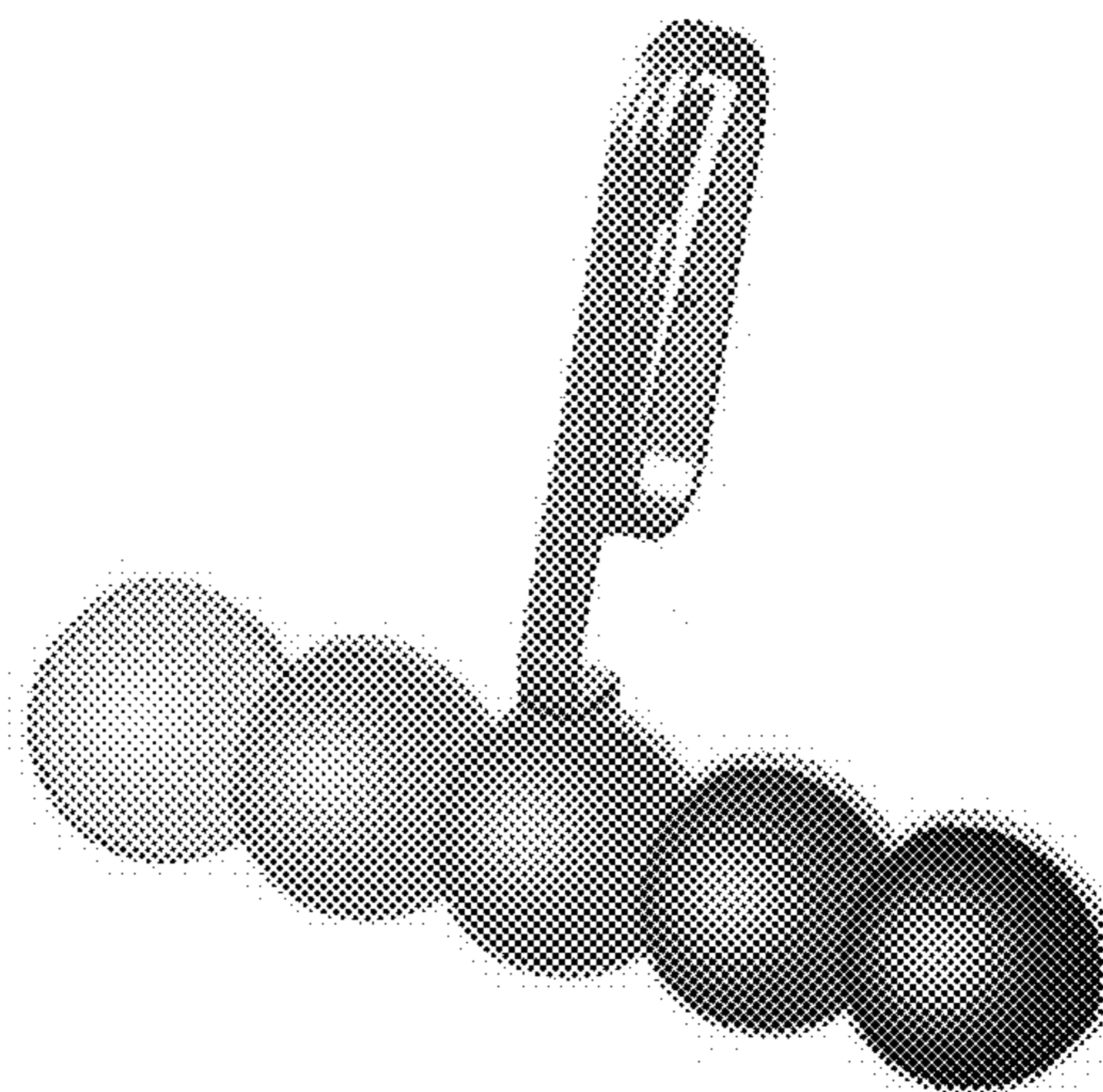
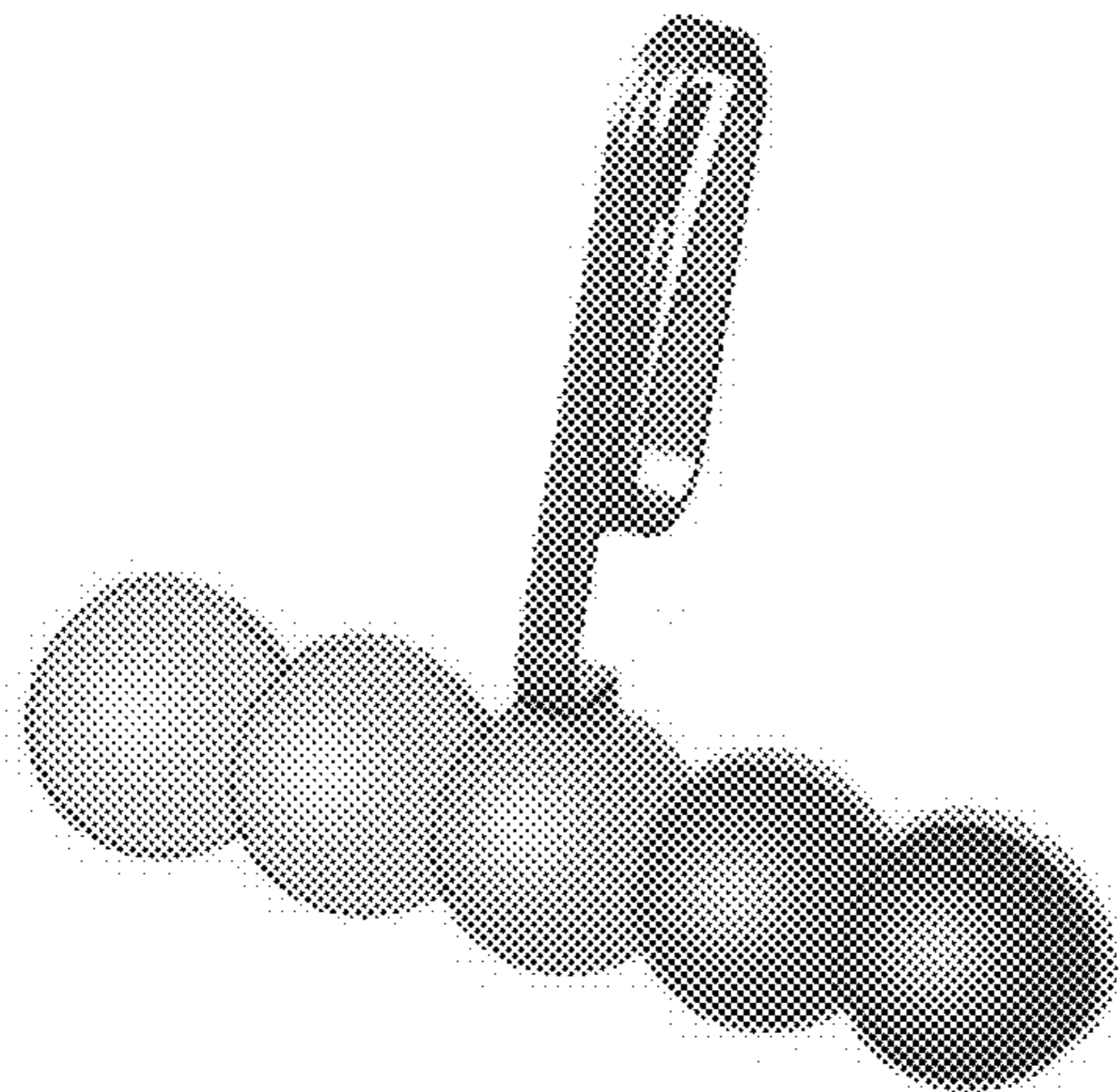

- 4.5 is a top plan view thereof;
- 4.6 is a bottom plan view thereof;
- 4.7 is a front, right perspective view thereof;
- 5.1 is a front elevation view of toilet rim block, showing my new design in accordance with an embodiment of the present invention;
- 5.2 is a rear elevation view thereof;
- 5.3 is a right side elevation view thereof;
- 5.4 is a left side elevation view thereof;
- 5.5 is a top plan view thereof;
- 5.6 is a bottom plan view thereof;
- 5.7 is a front, right perspective view thereof;
- 6.1 is a front elevation view of toilet rim block, showing my new design in accordance with an embodiment of the present invention;
- 6.2 is a rear elevation view thereof;
- 6.3 is a right side elevation view thereof;
- 6.4 is a left side elevation view thereof;
- 6.5 is a top plan view thereof;
- 6.6 is a bottom plan view thereof; and
- 6.7 is a front, right perspective view thereof.

**1 Claim, 42 Drawing Sheets**  
**(35 of 42 Drawing Sheet(s) Filed in Color)**

(58) **Field of Classification Search**

CPC ..... A61L 9/00; A61L 9/02; A61L 9/03; A61L 9/032; A61L 9/035; A61L 9/037; A61L 9/04; A61L 9/12; A61L 9/22; C11D 17/041; C11D 17/0056; E03D 9/032; E03D 9/037; E03D 9/038

See application file for complete search history.

(56) **References Cited**

U.S. PATENT DOCUMENTS

D656,576	S *	3/2012	Muhlhausen .....	D23/208
D659,793	S *	5/2012	Muhlhausen .....	D23/208
D722,154	S *	2/2015	Muller .....	D23/368
D726,893	S *	4/2015	Muller .....	D23/366
D762,810	S *	8/2016	Venini .....	D23/208
D787,631	S *	5/2017	Gerhards .....	D23/208
D788,262	S *	5/2017	Gerhards .....	D23/208
D791,911	S *	7/2017	Muller .....	D23/208
2012/0047640	A1 *	3/2012	Warkotsch .....	E03D 9/032 4/223

\* cited by examiner



**1.1**

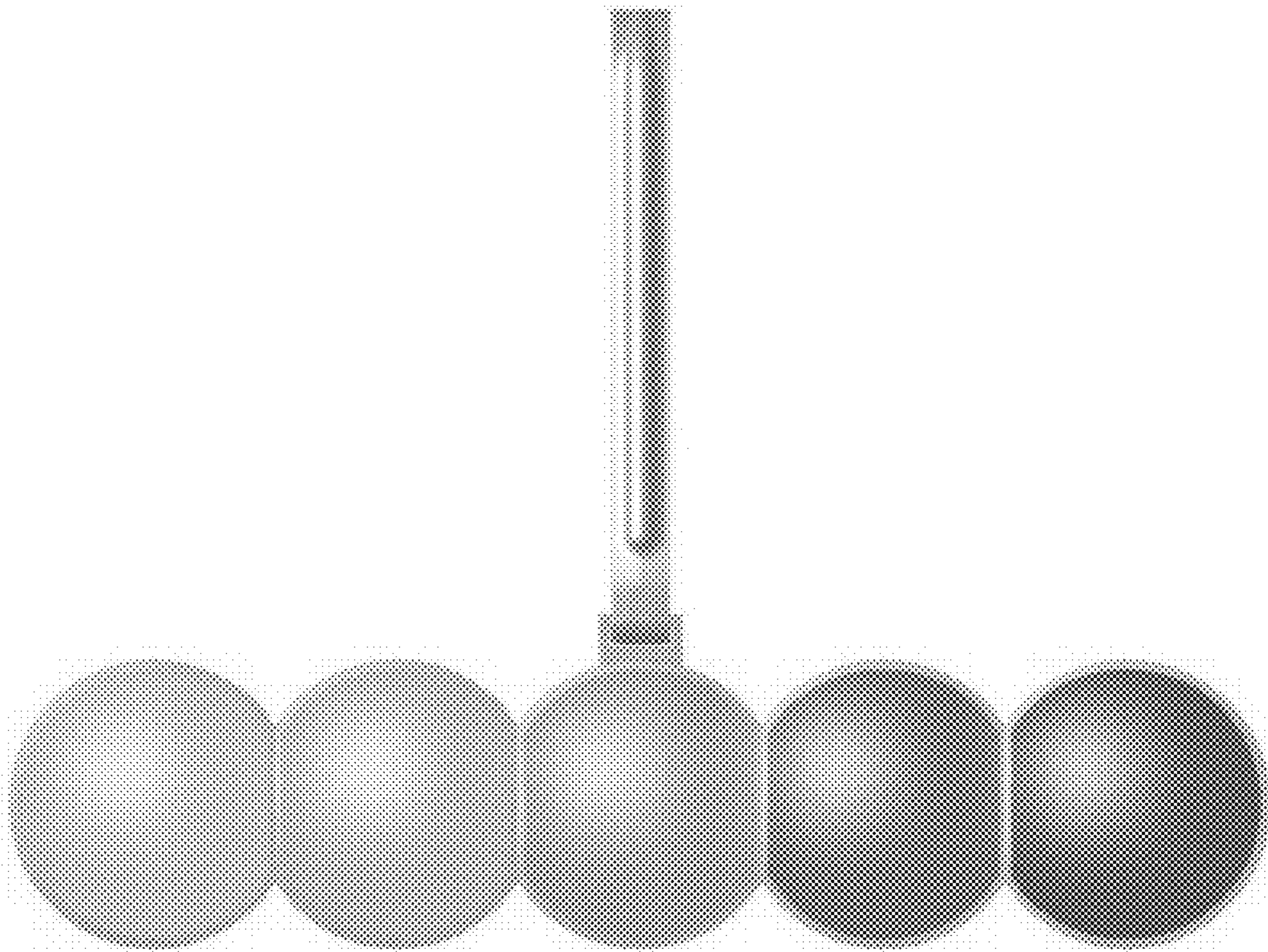

**1.2**

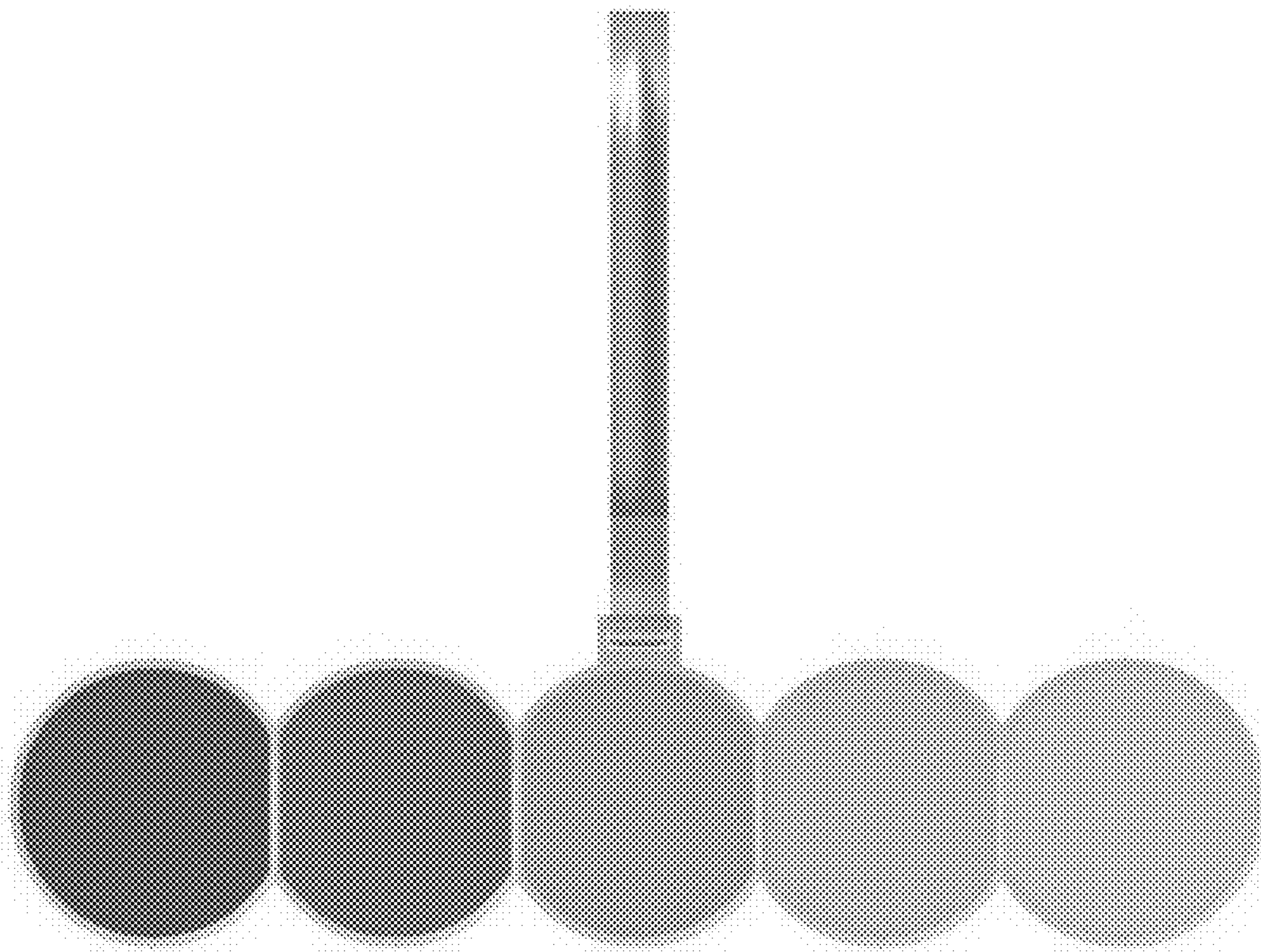

1.3

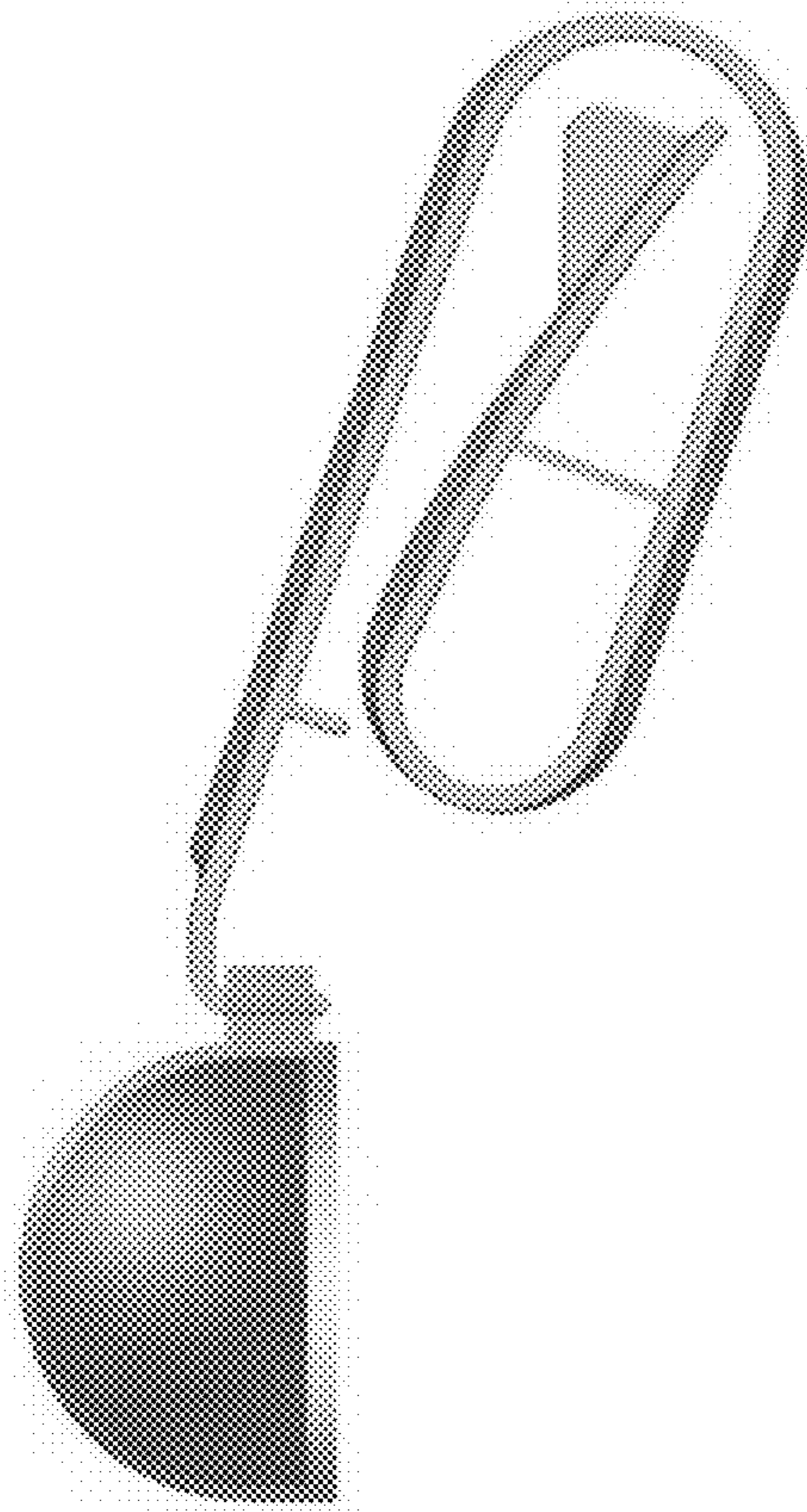

1.4

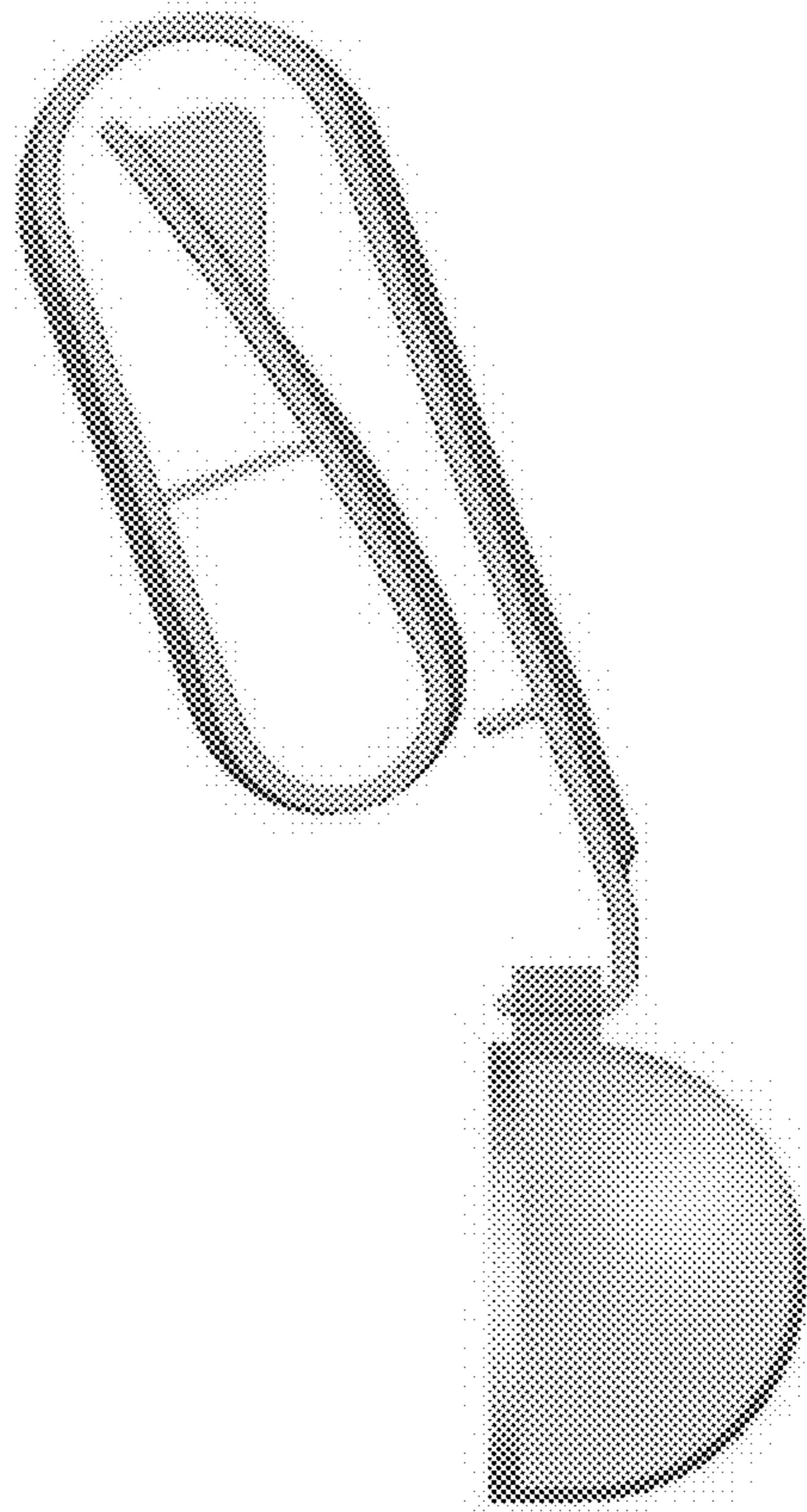



1.5

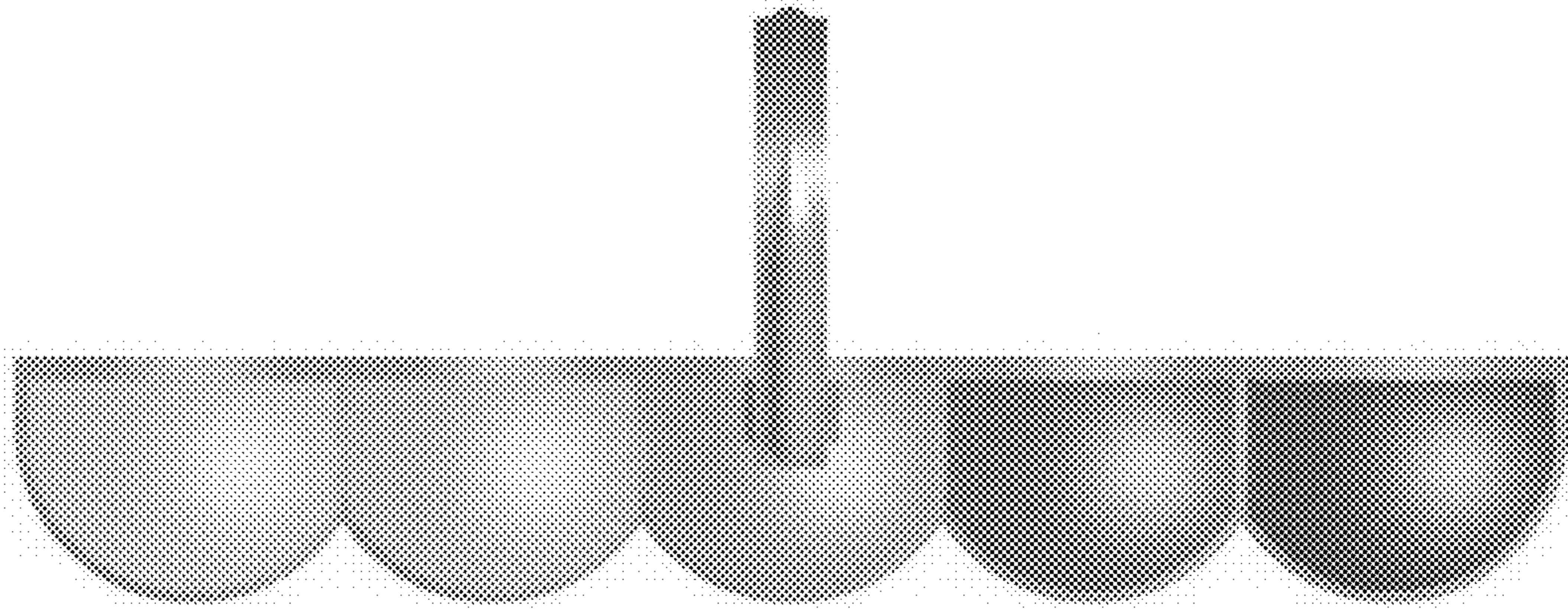

**1.6**

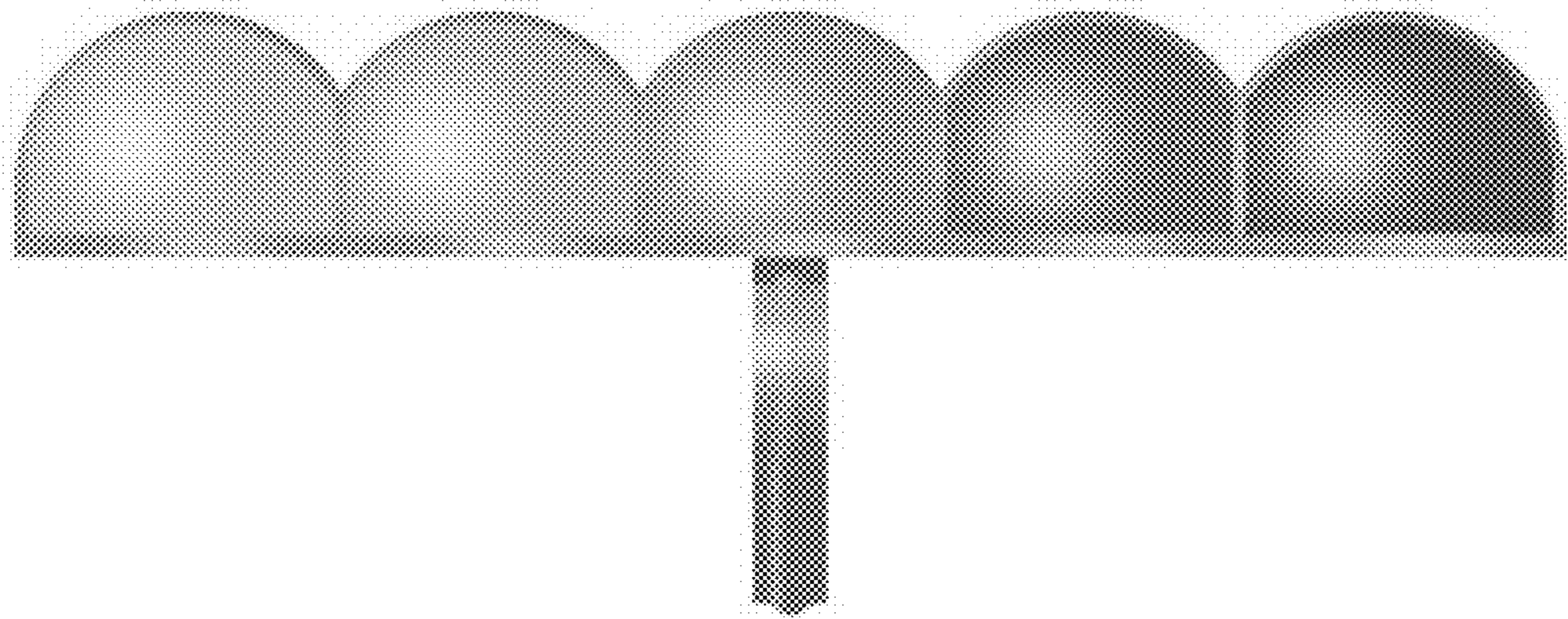



1.7

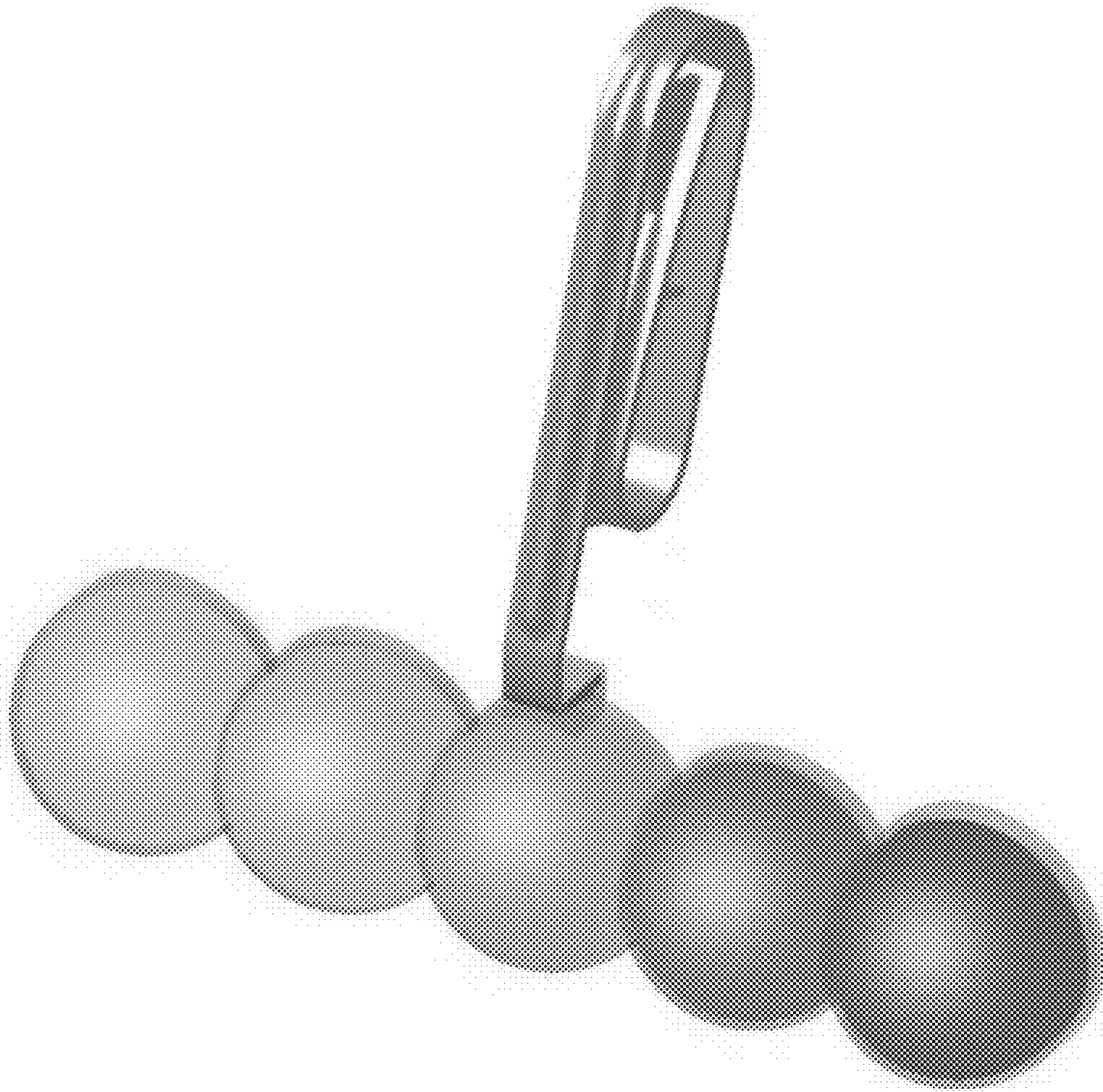

**2.1**

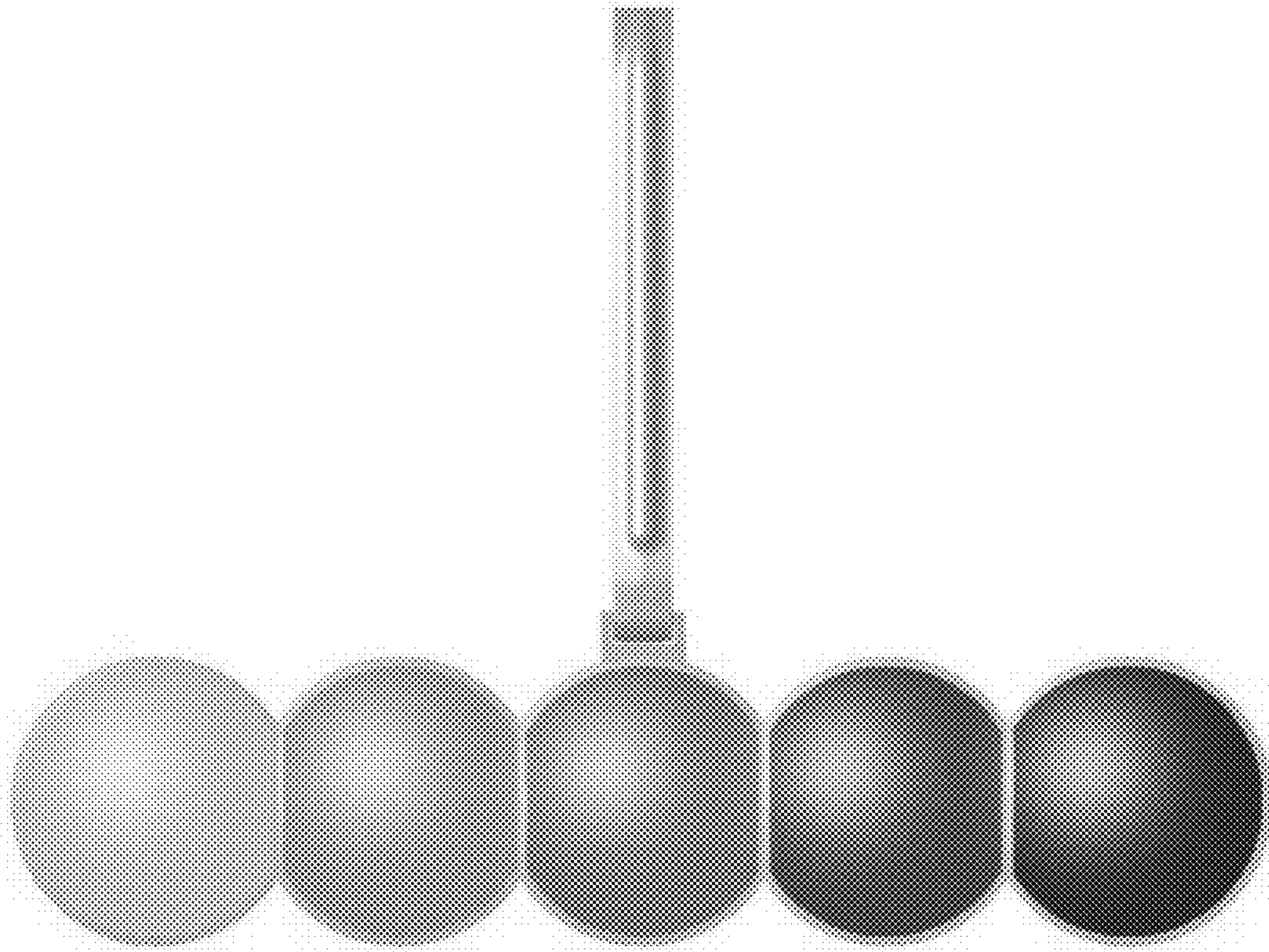



**2.2**

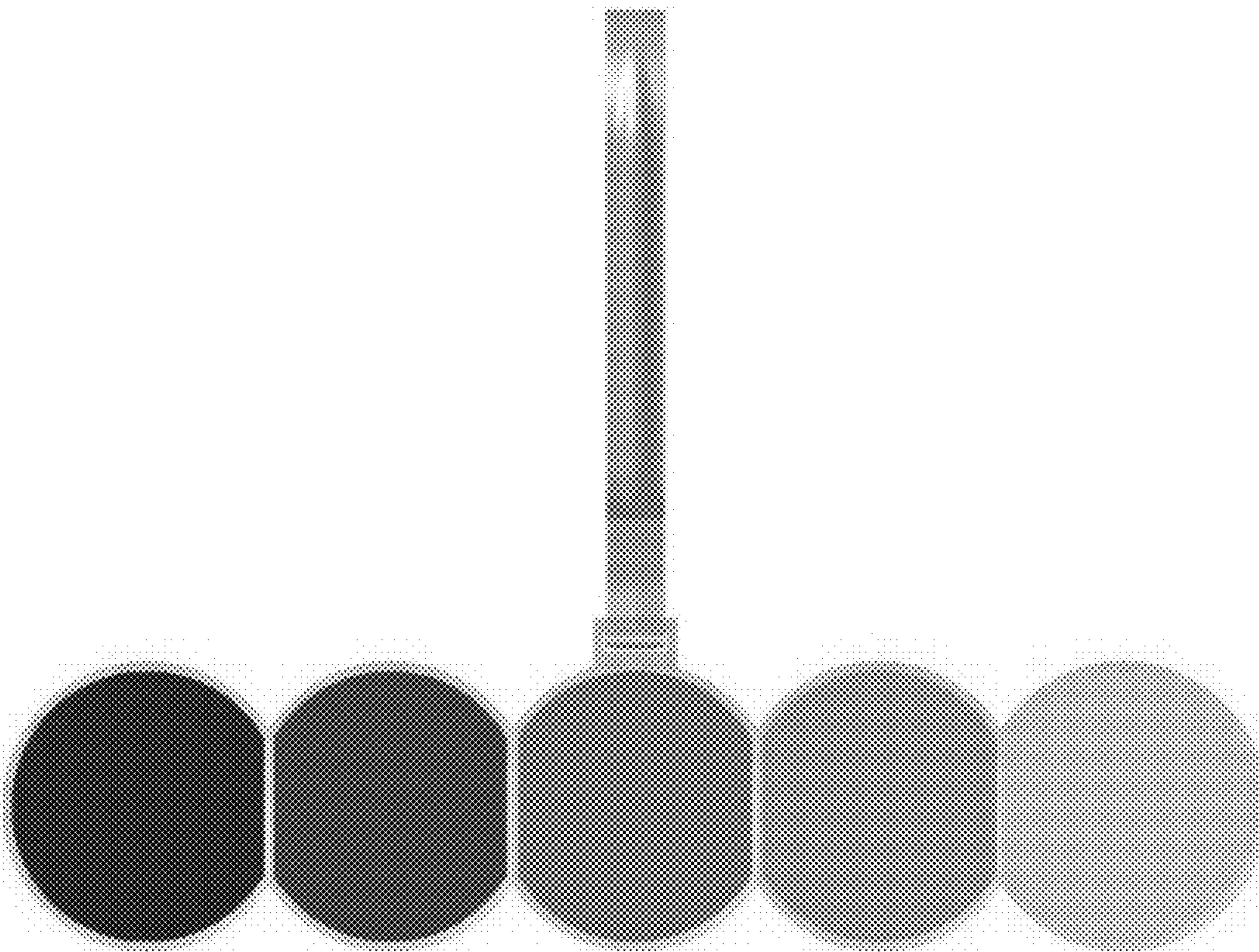



2.3

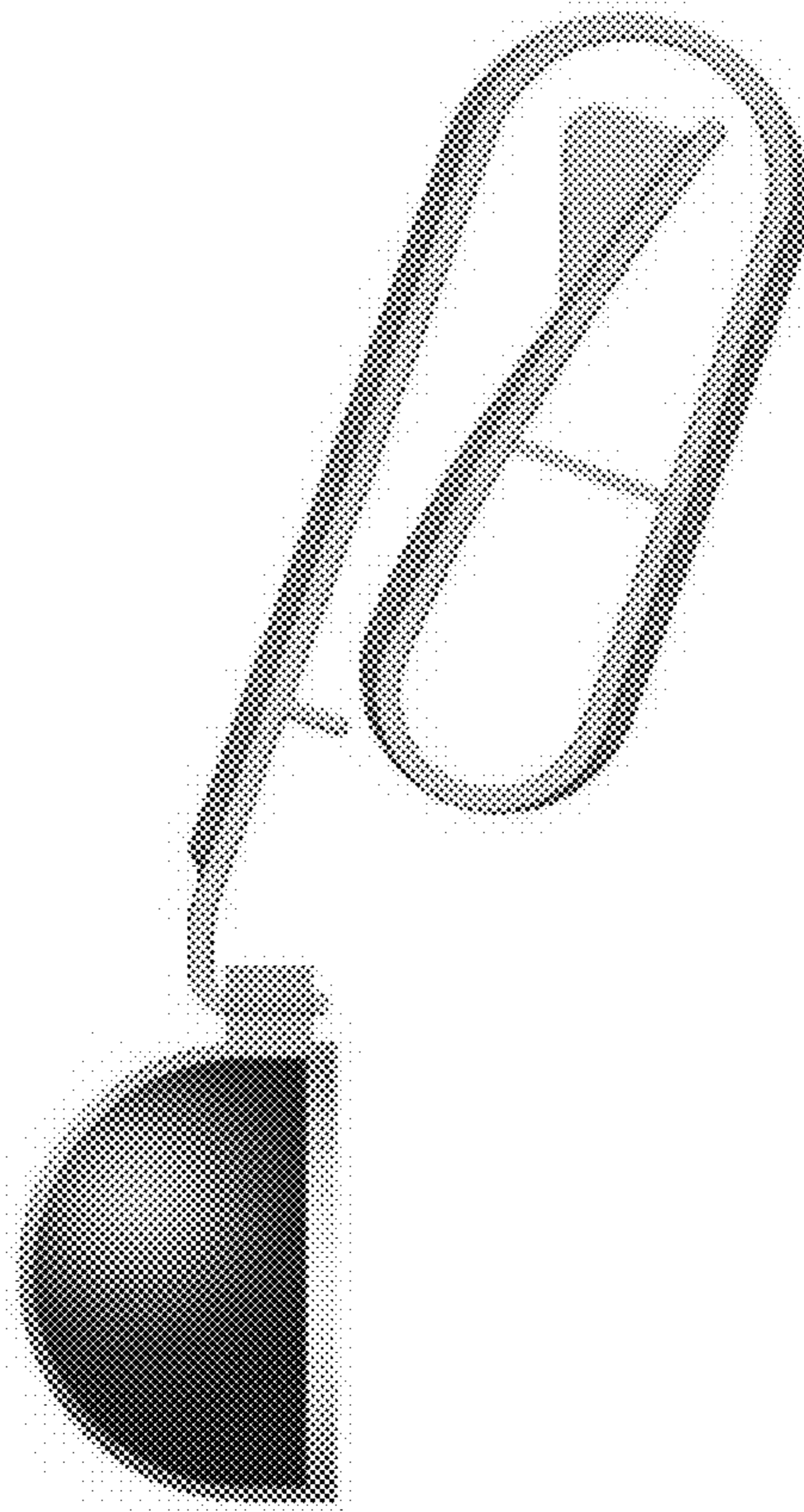

2.4

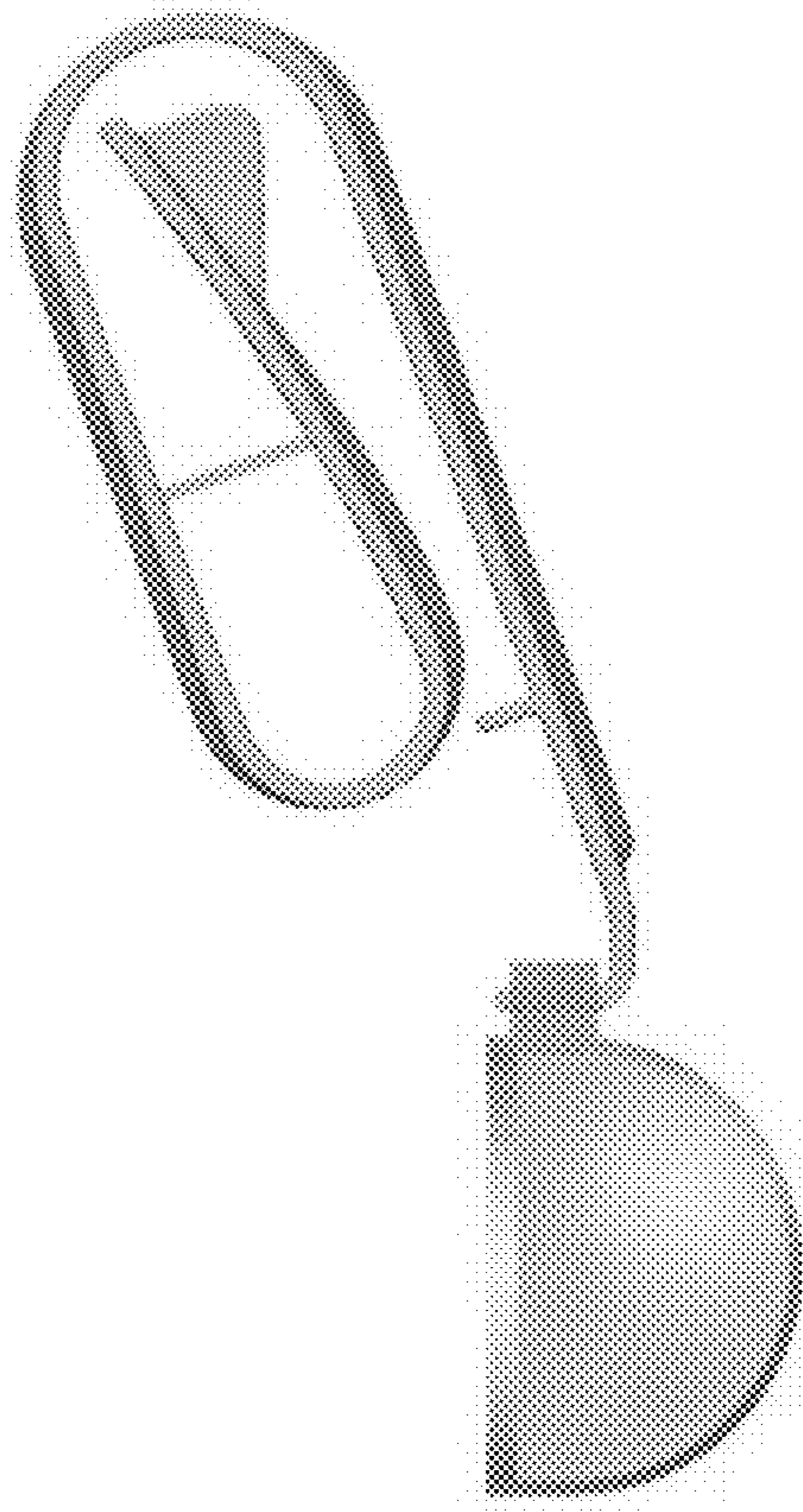

2.5

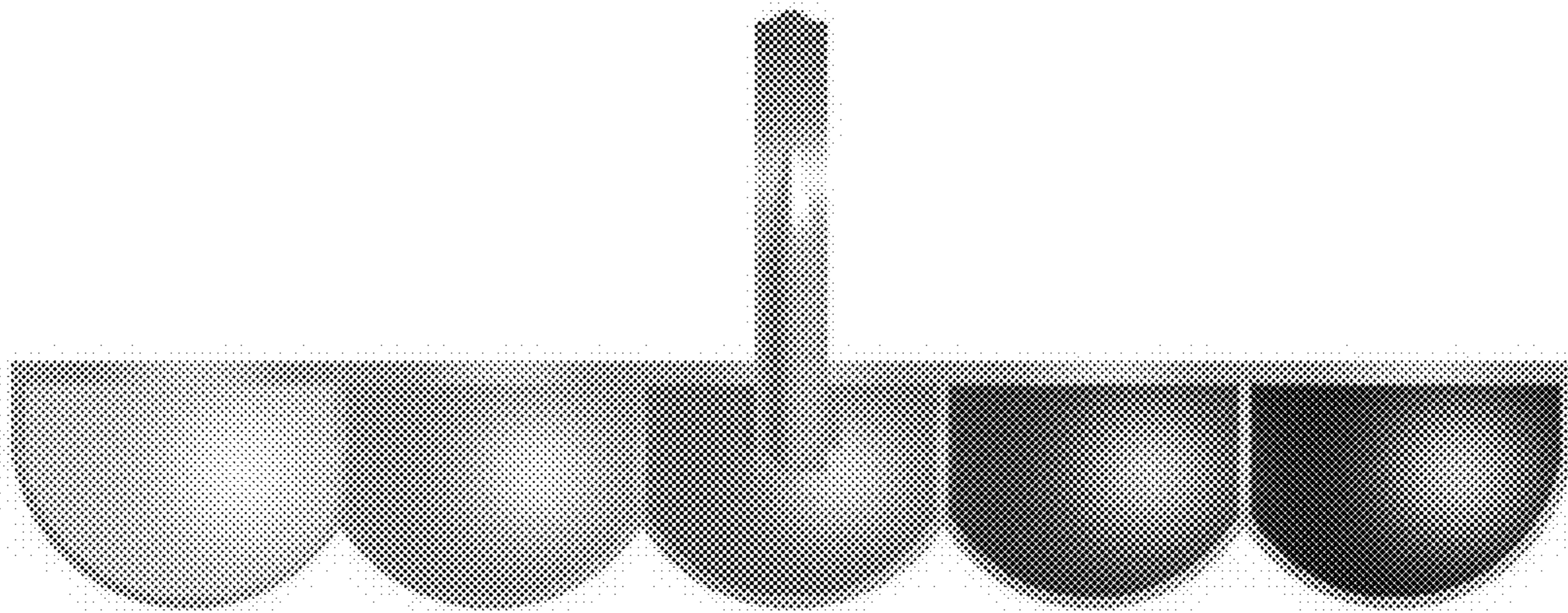



**2.6**

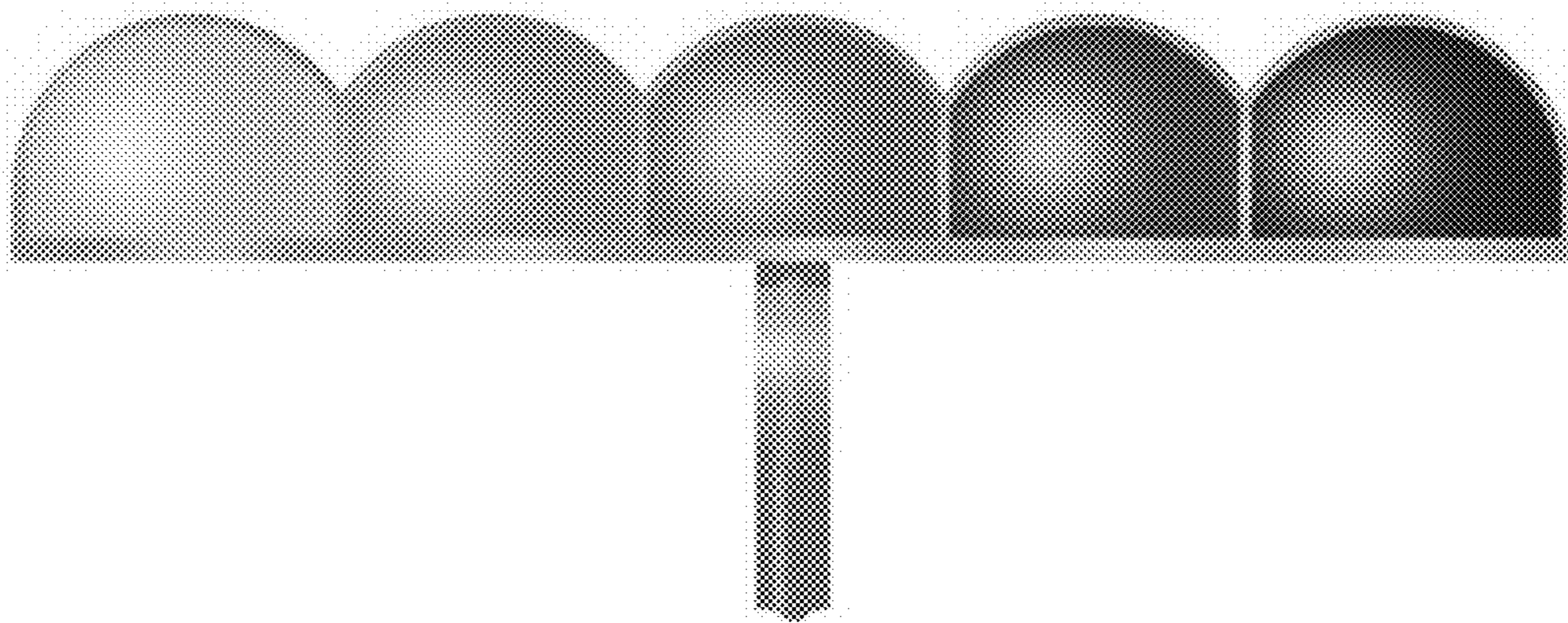

2.7

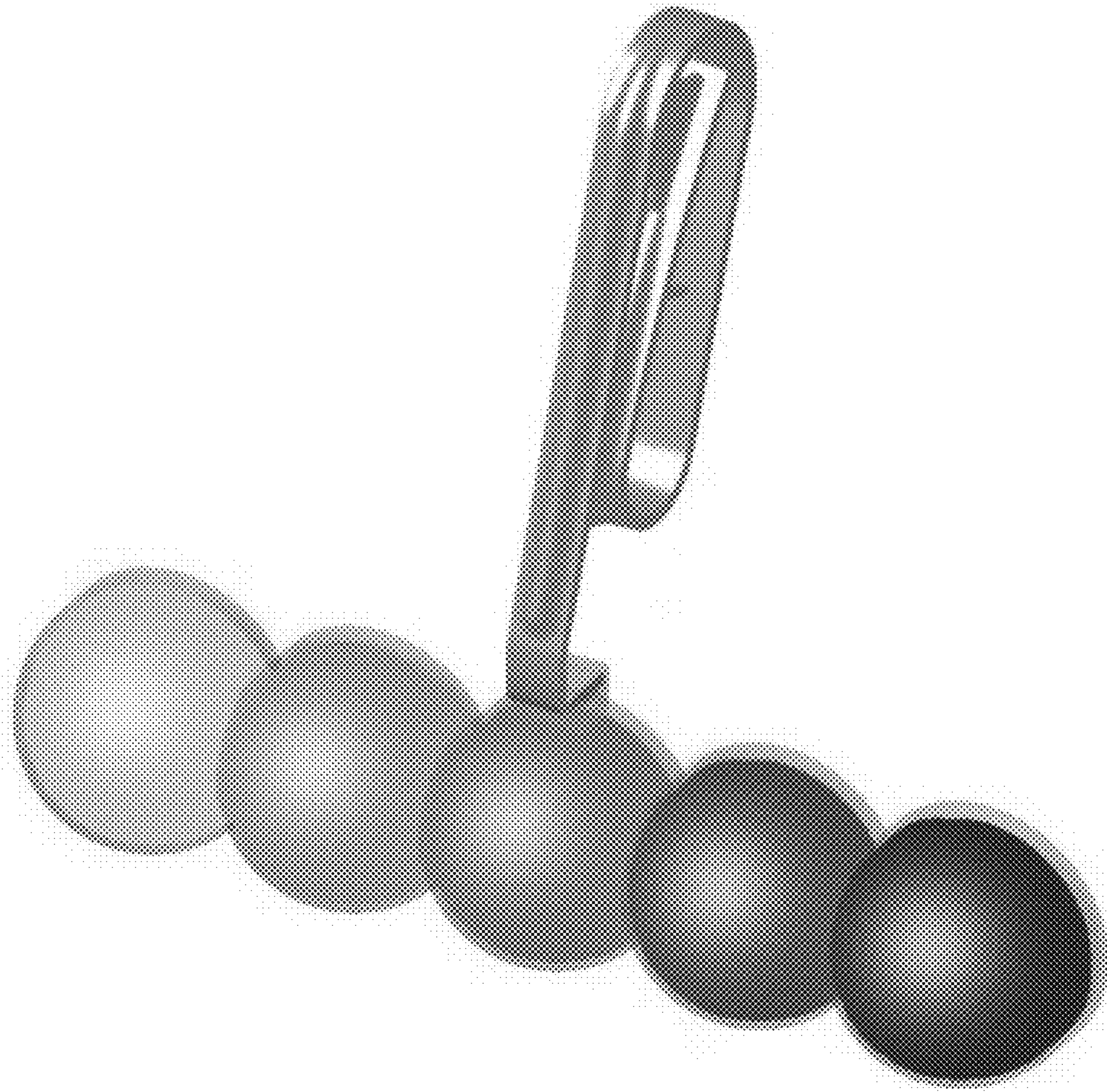

**3.1**

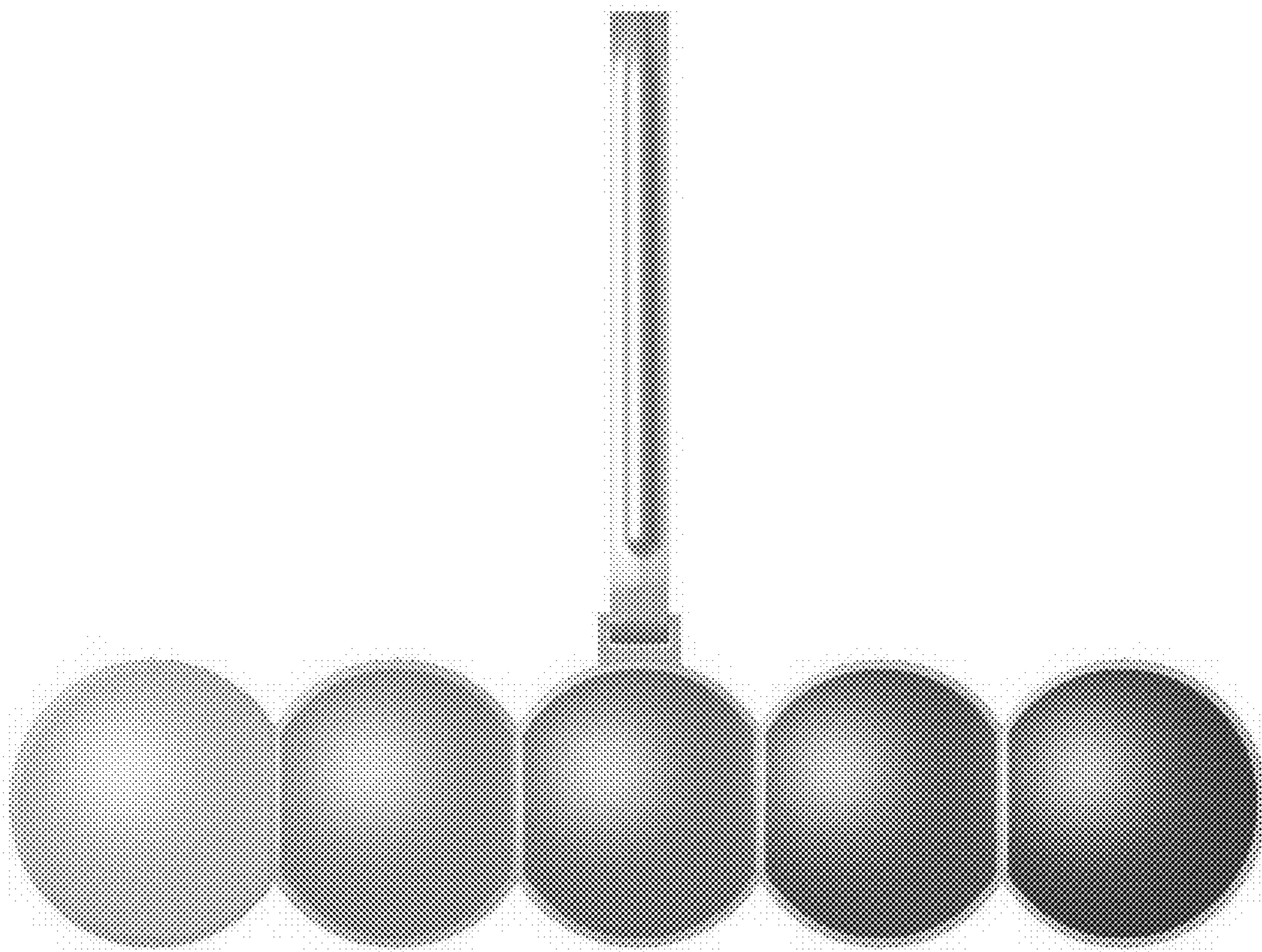



**3.2**

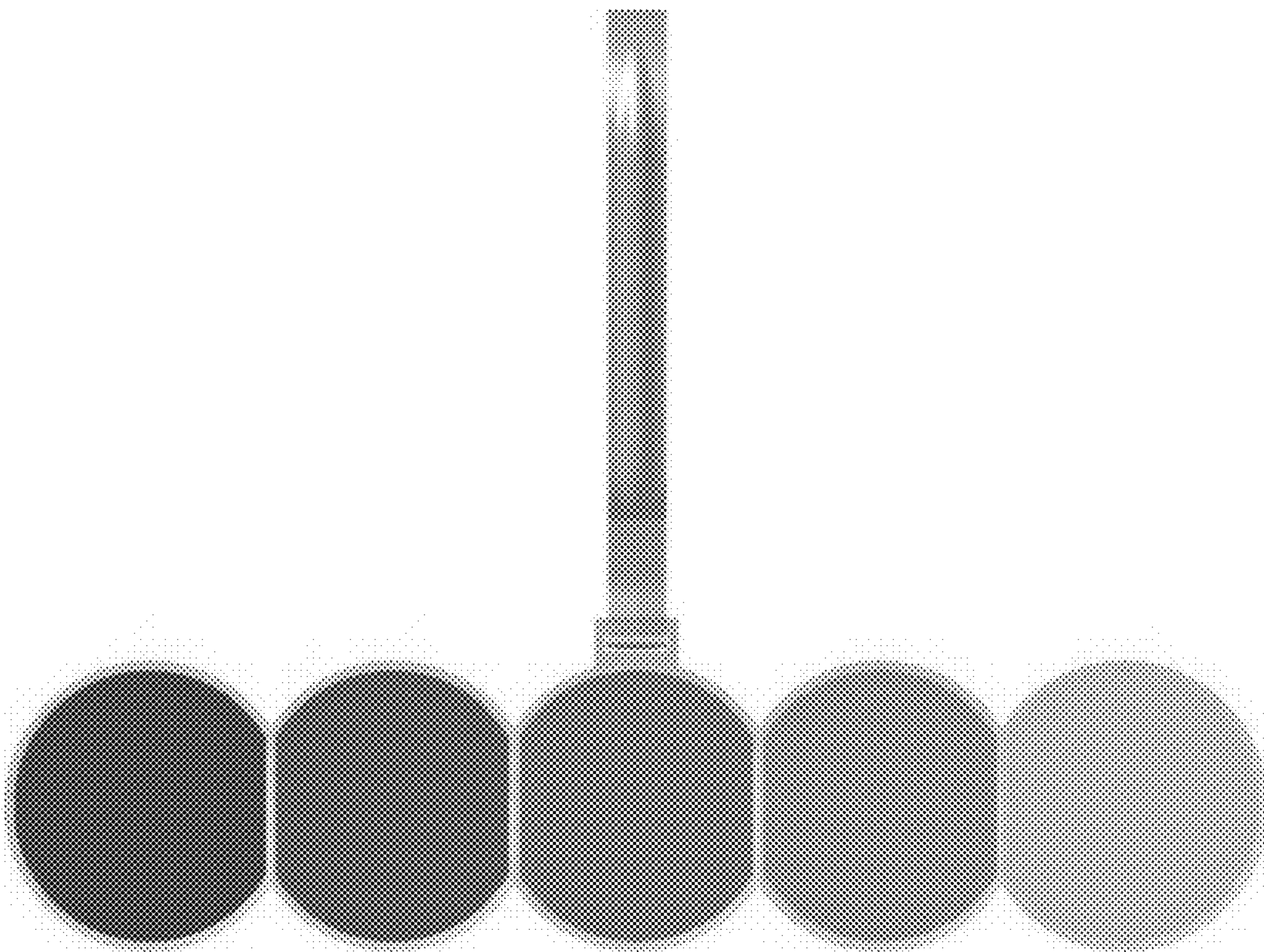

**3.3**

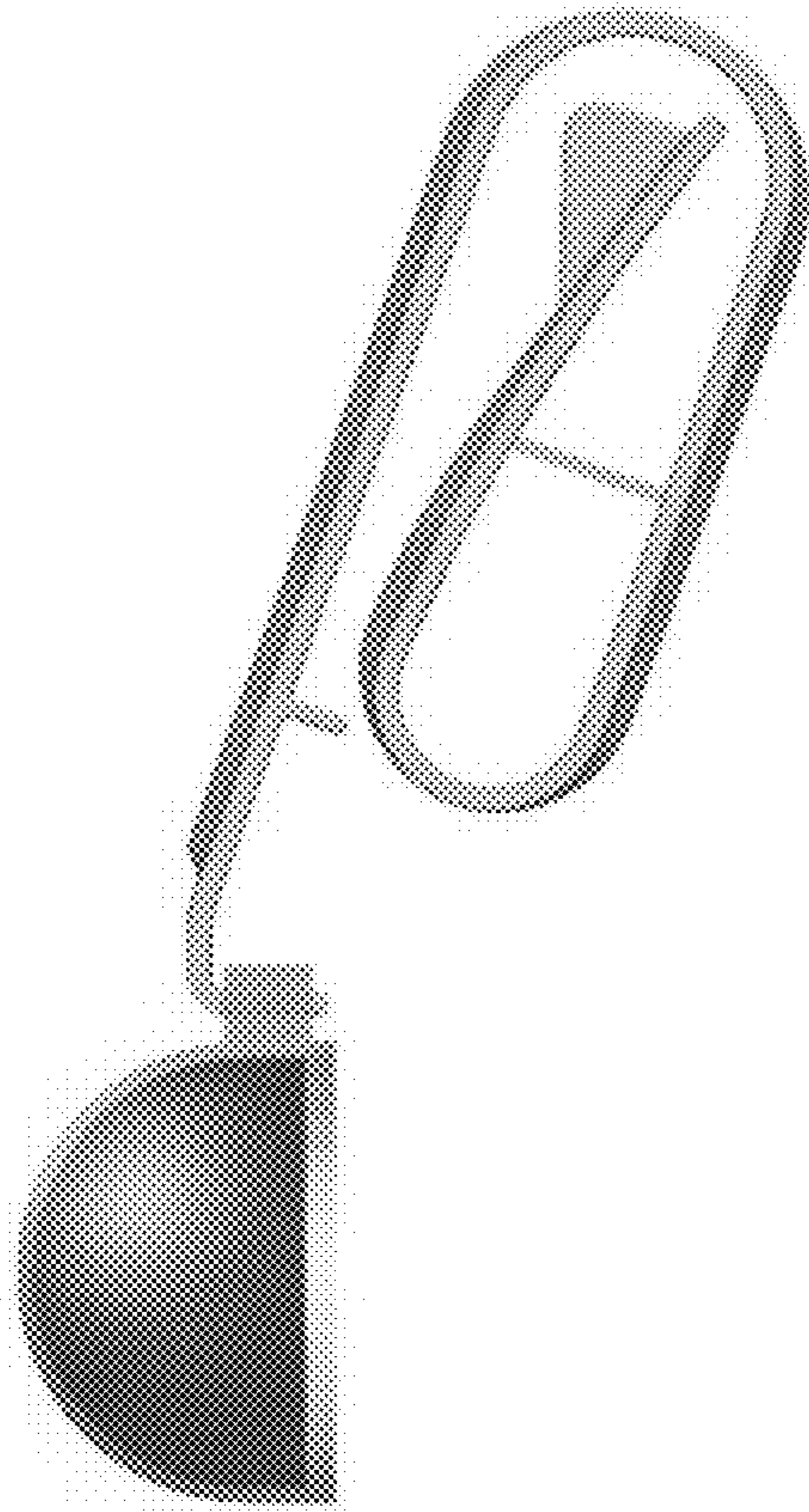

**3.4**

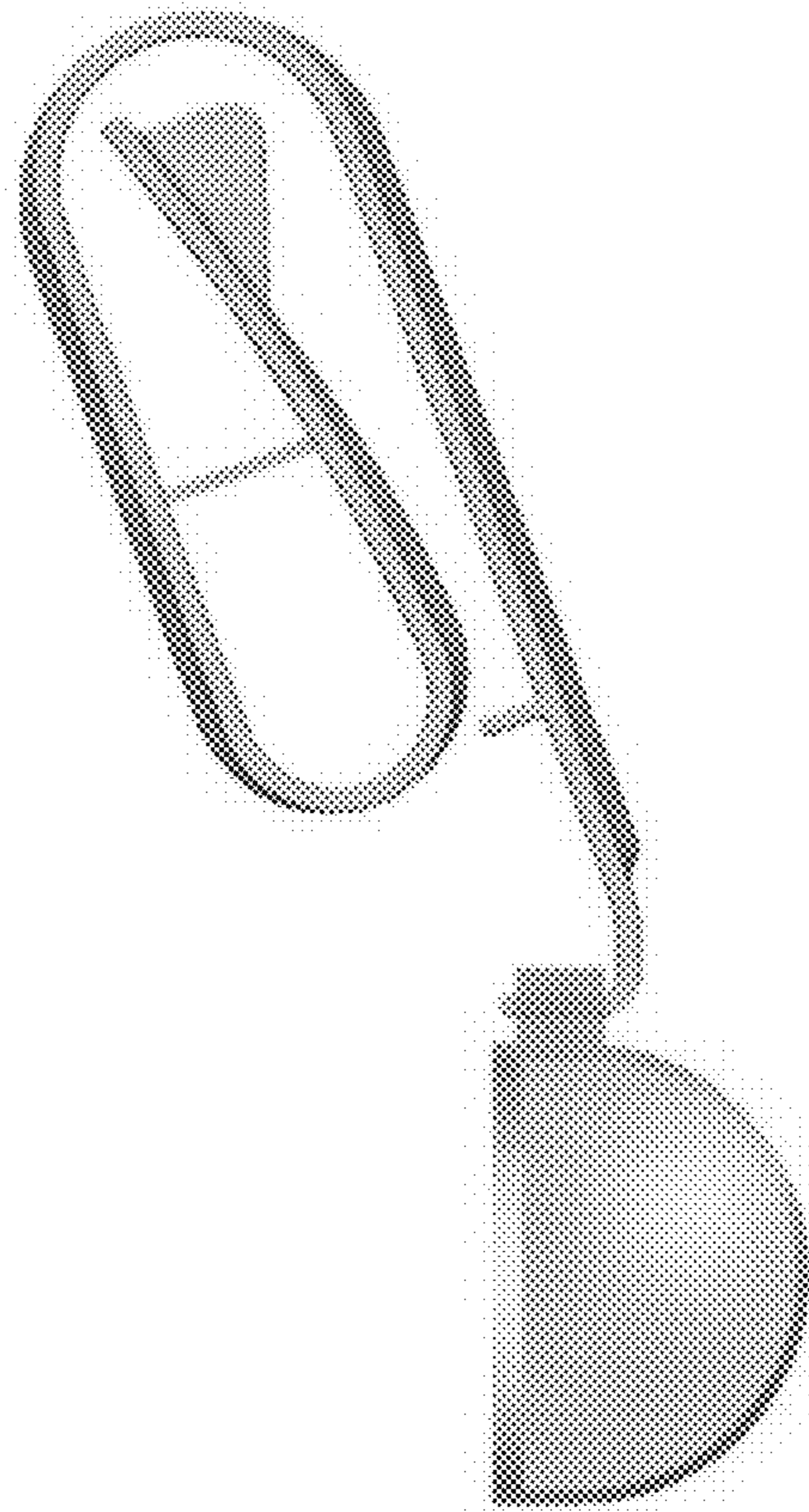



3.5

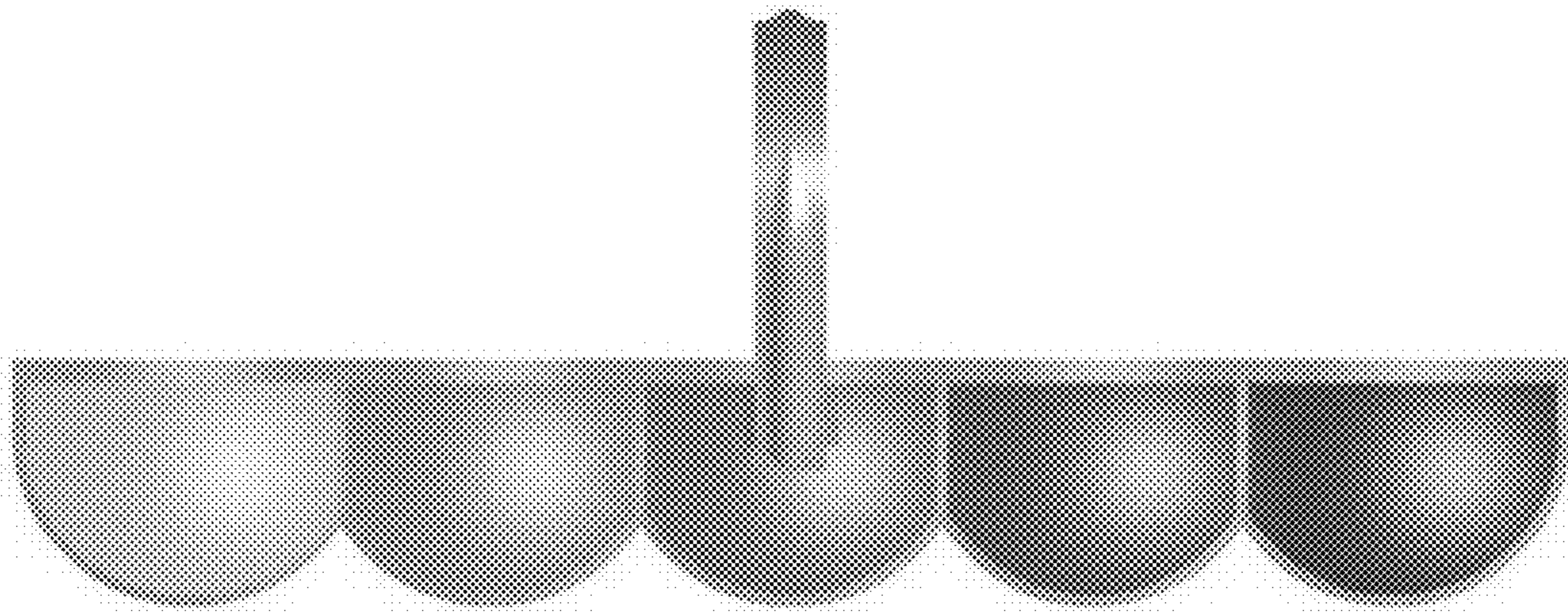

**3.6**

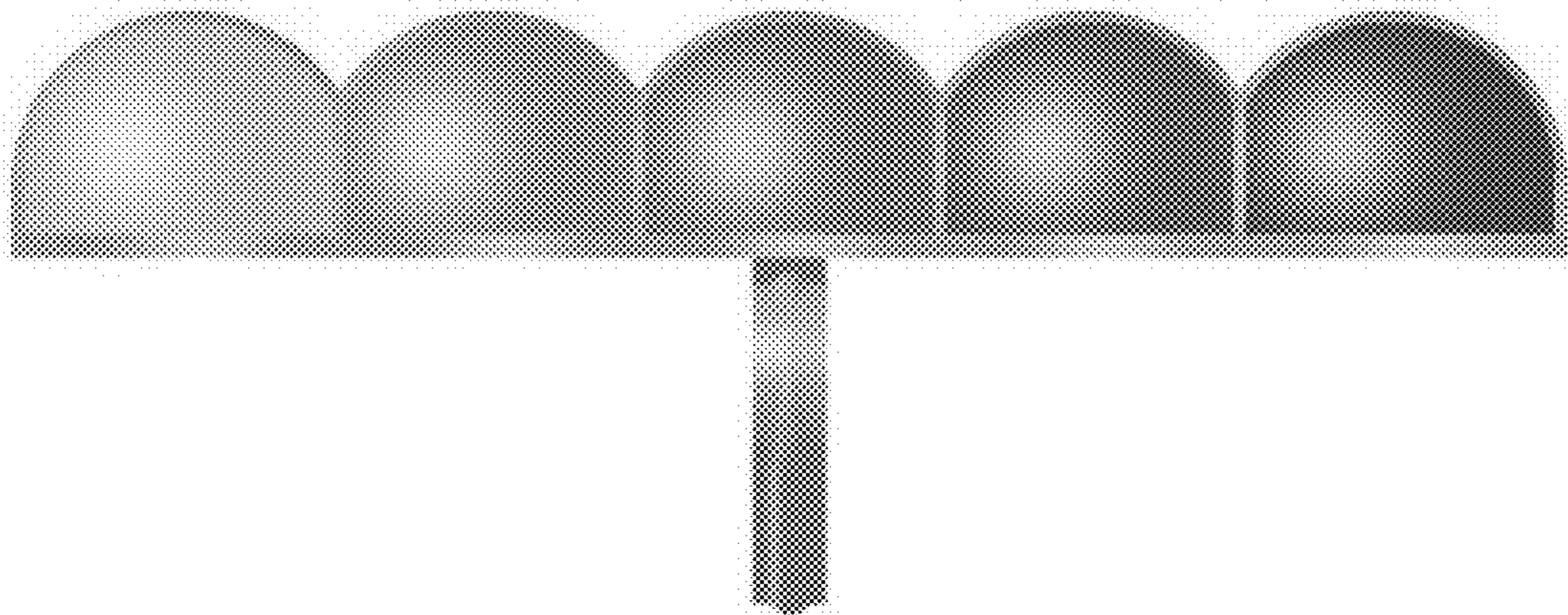

3.7

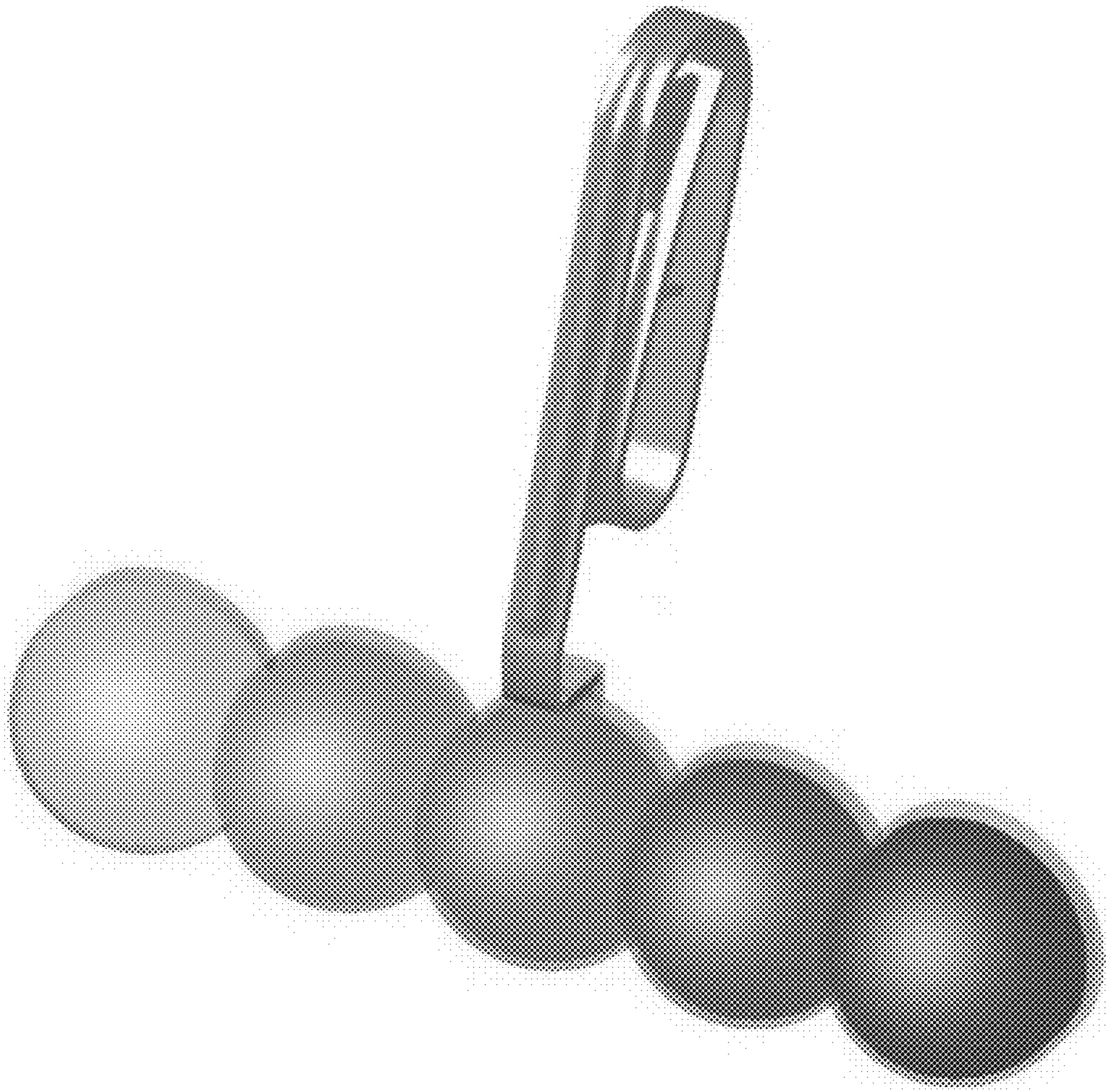



4.1

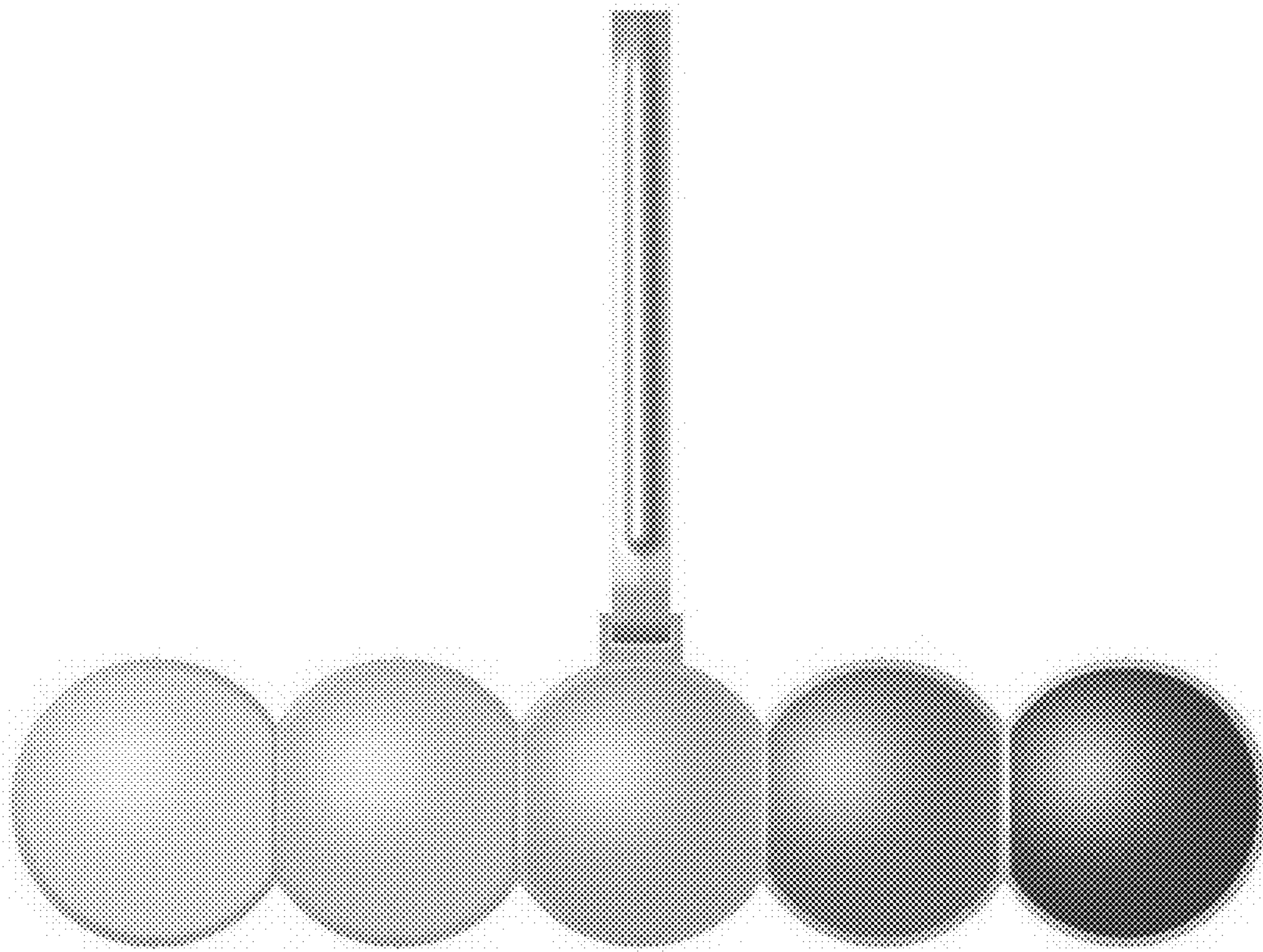

4.2

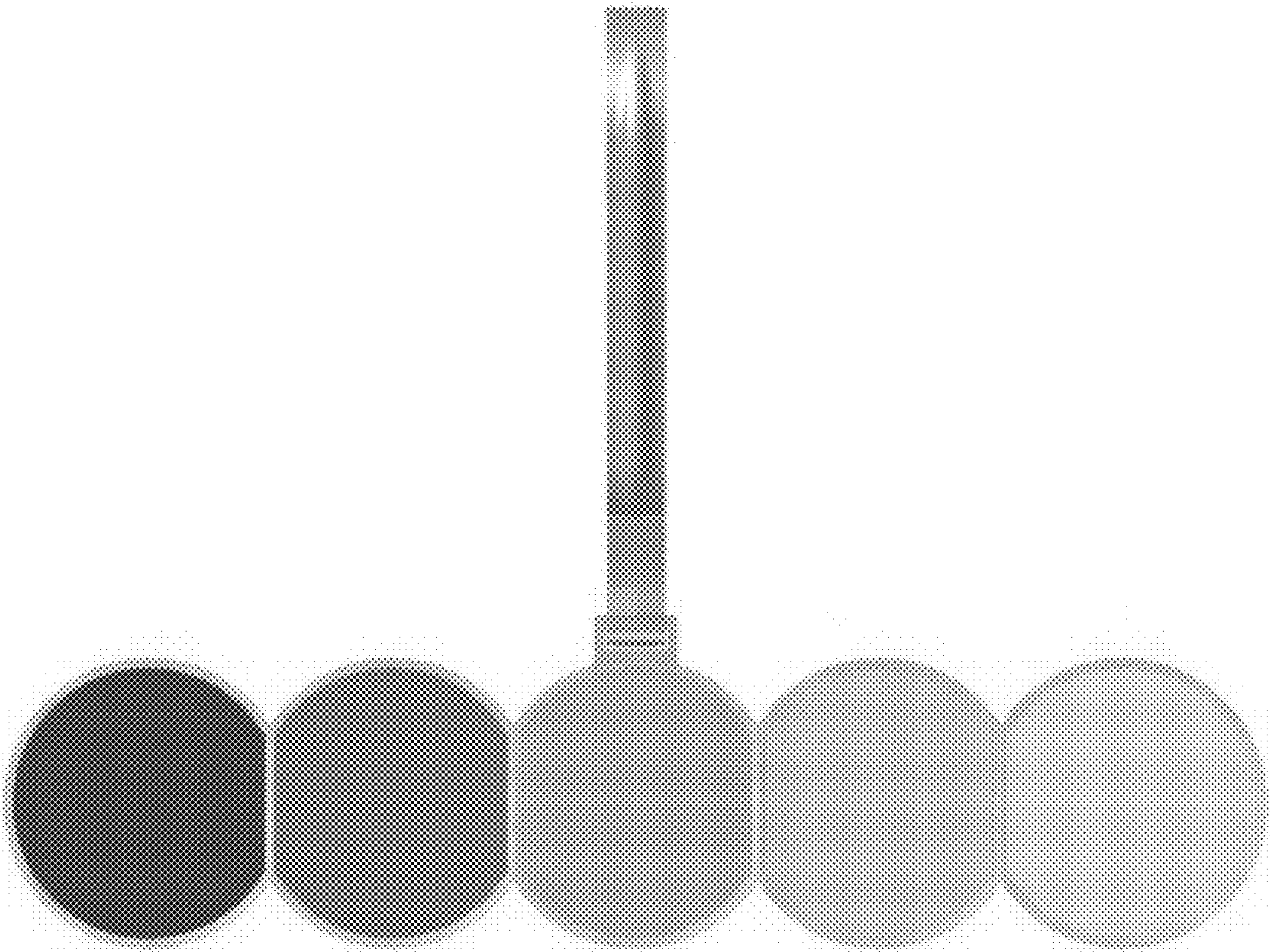

4.3

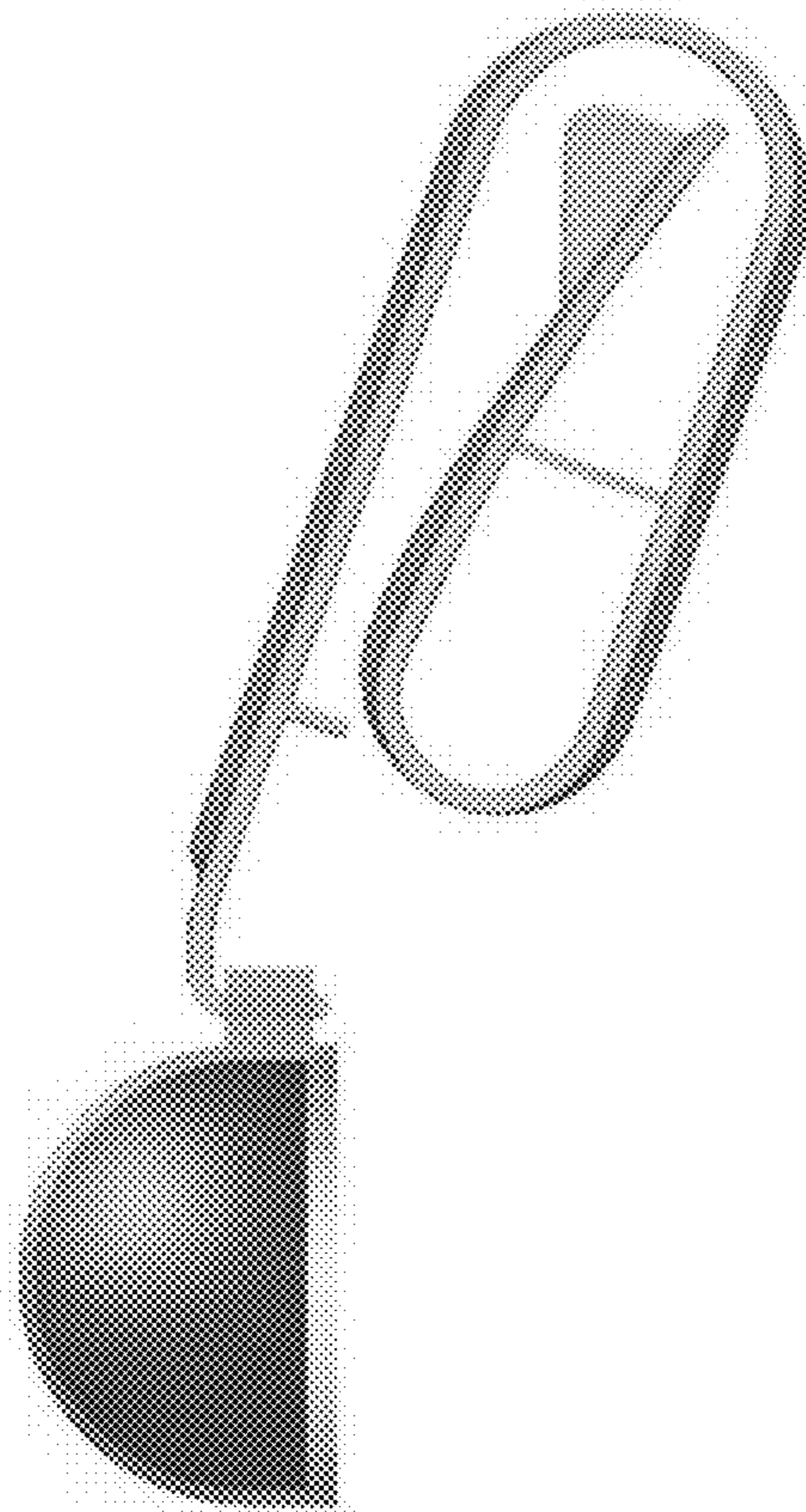



4.4

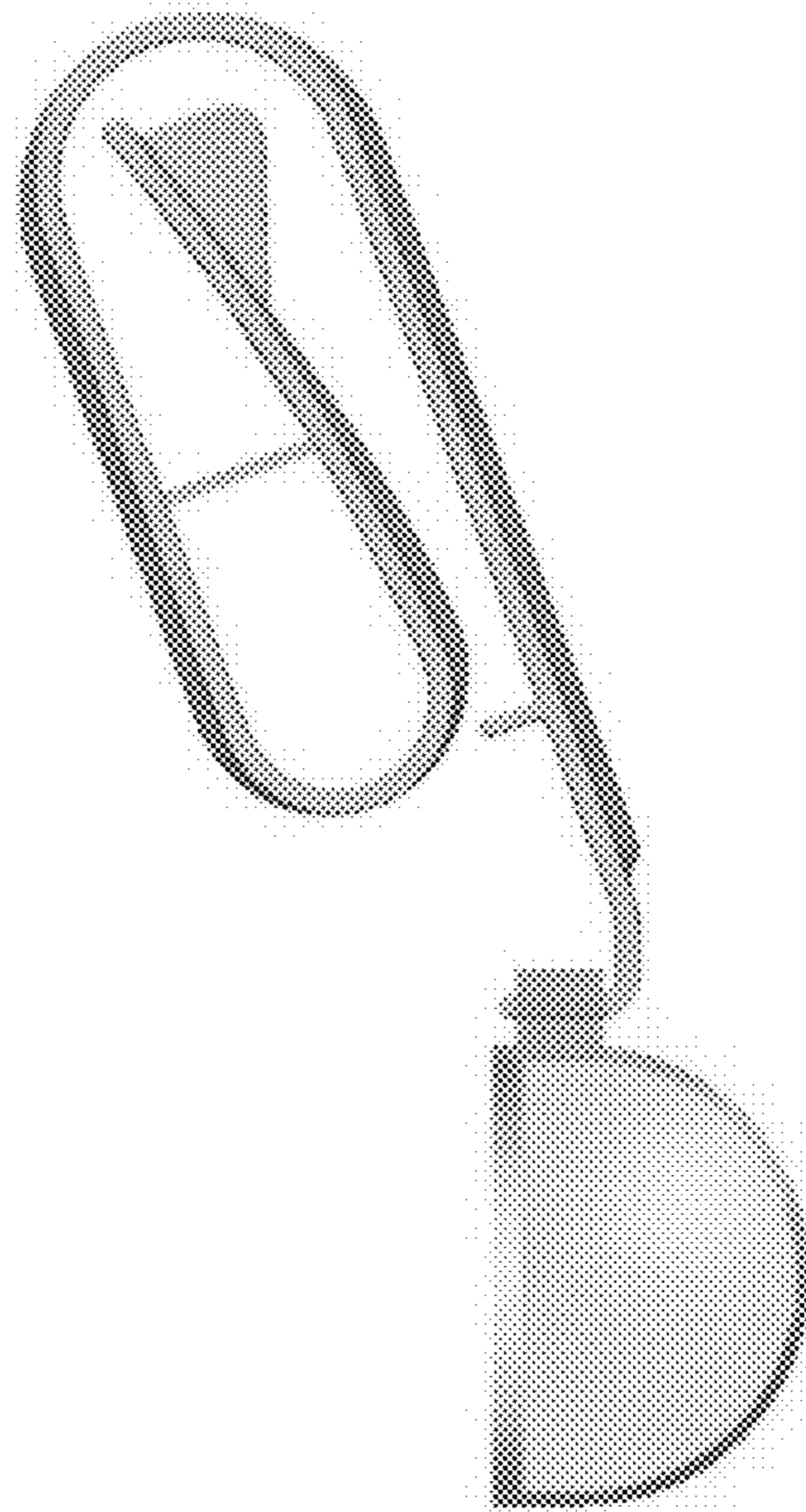

4.5

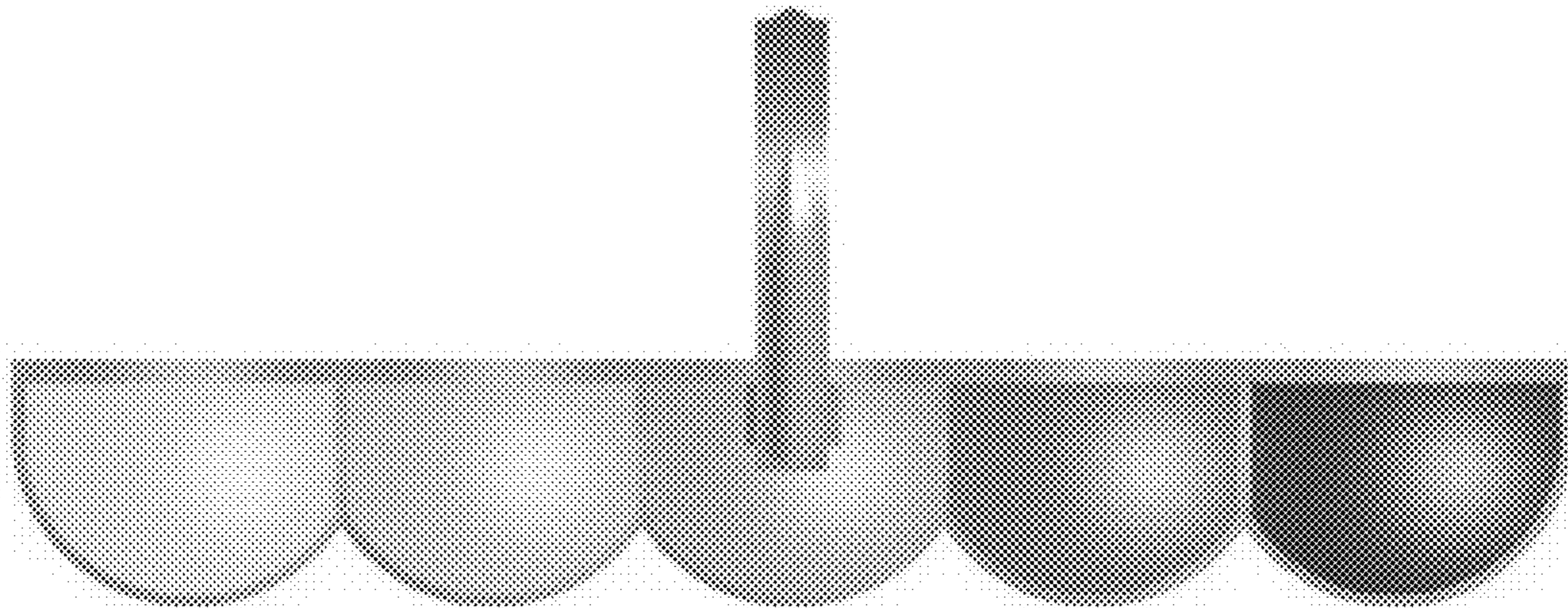

**4.6**

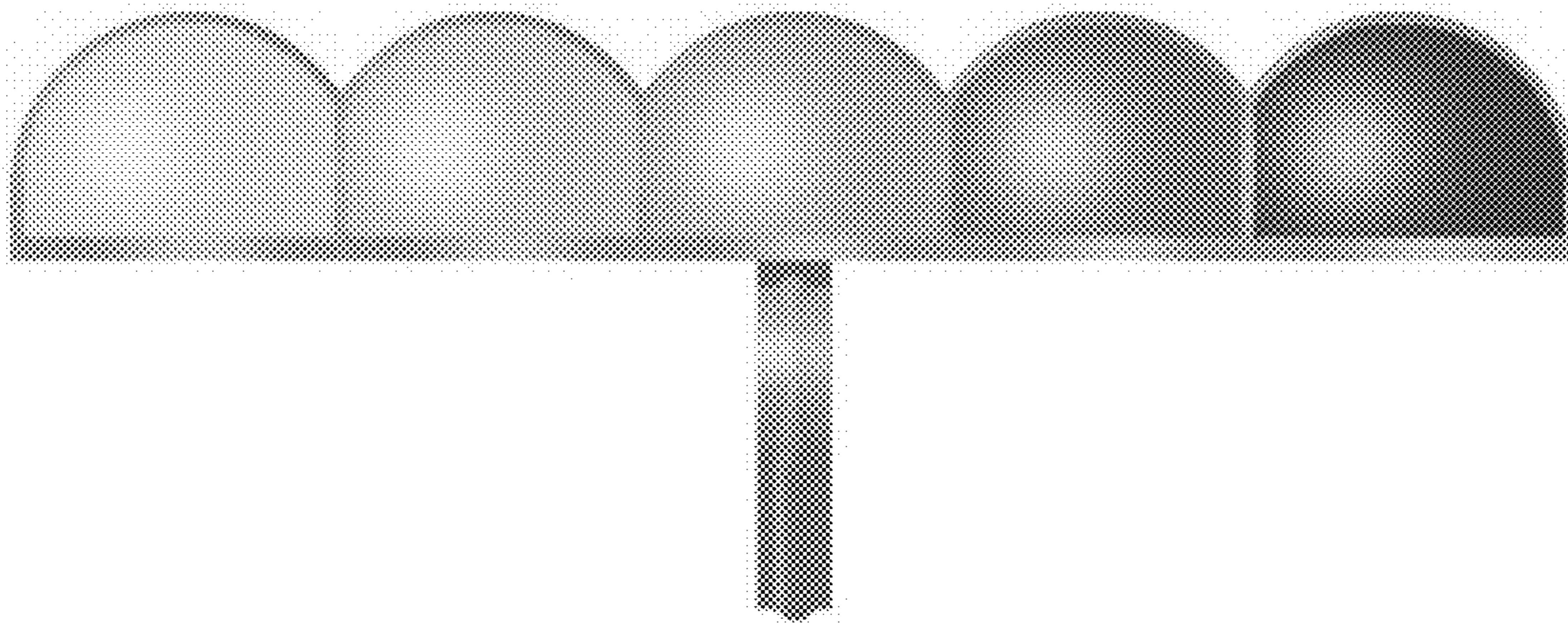



4.7

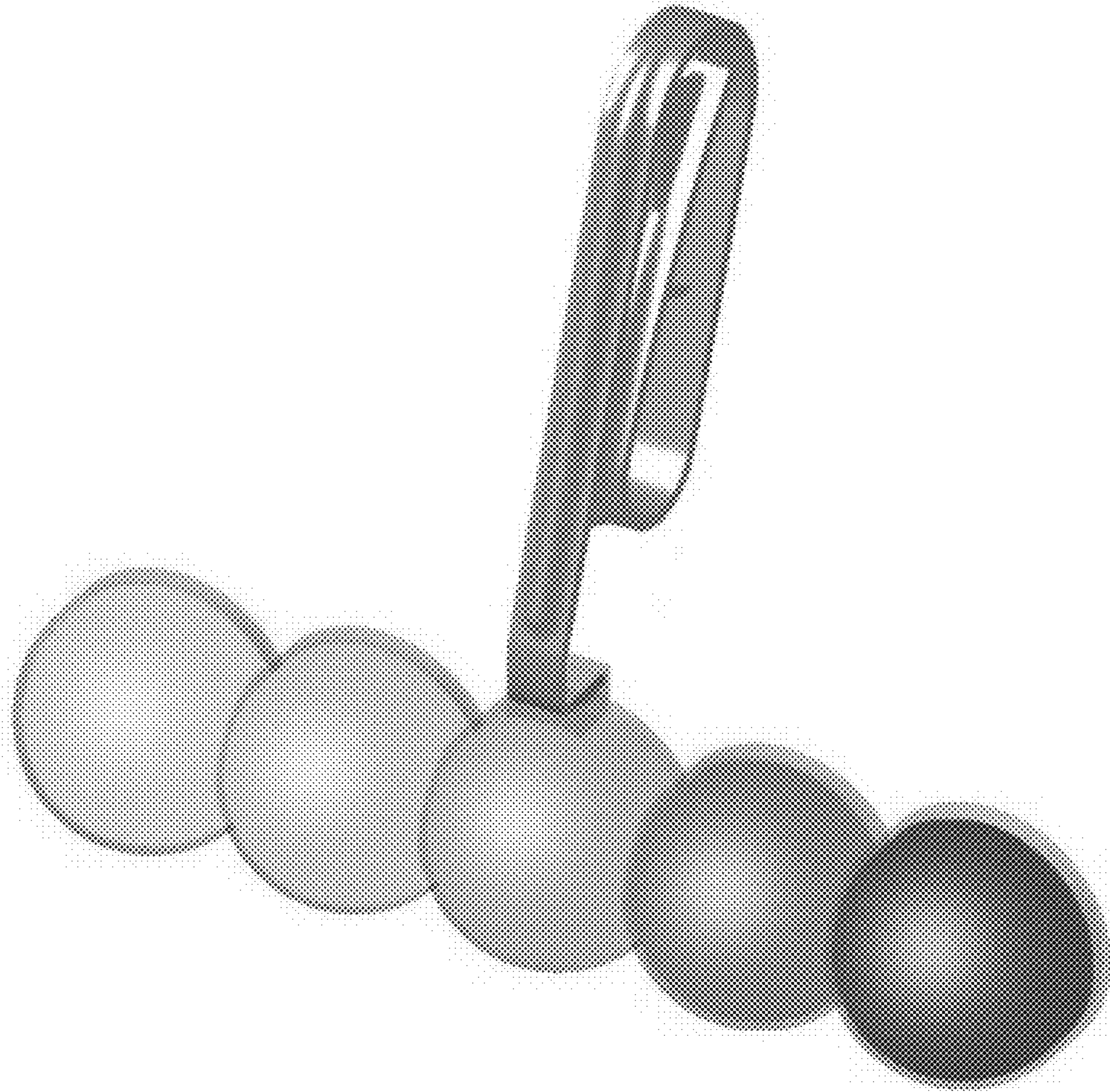

5.1

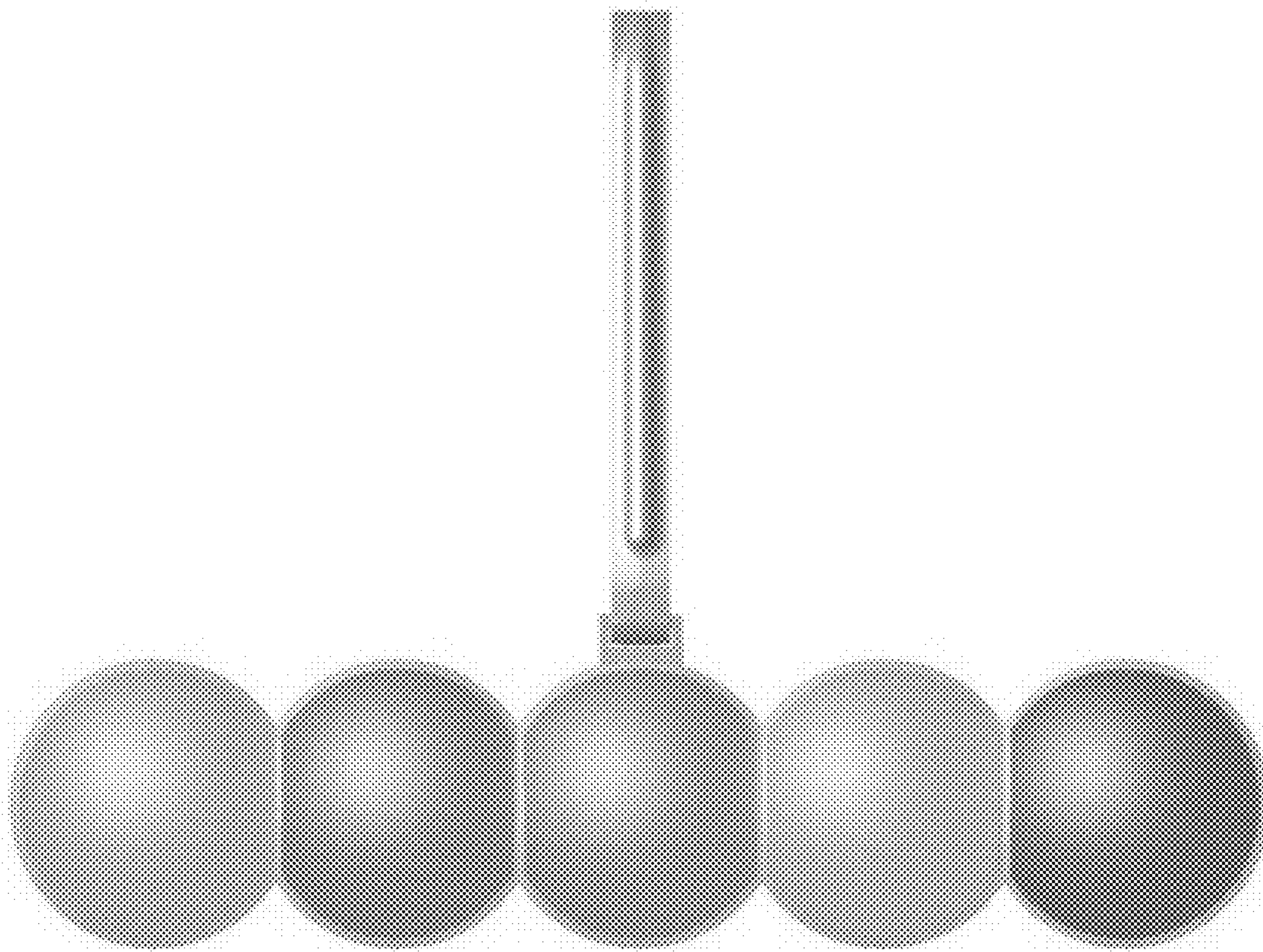

5.2

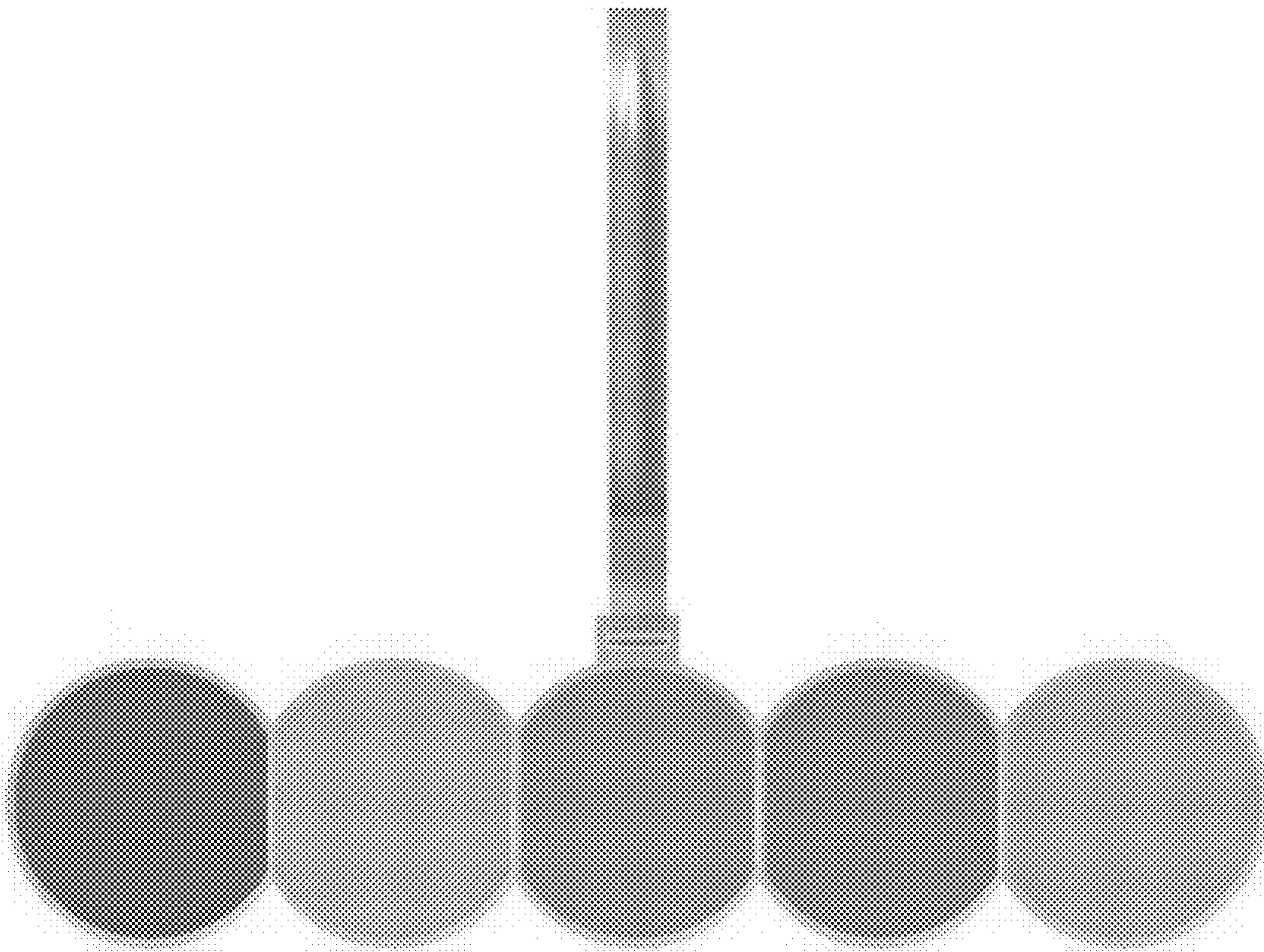



5.3

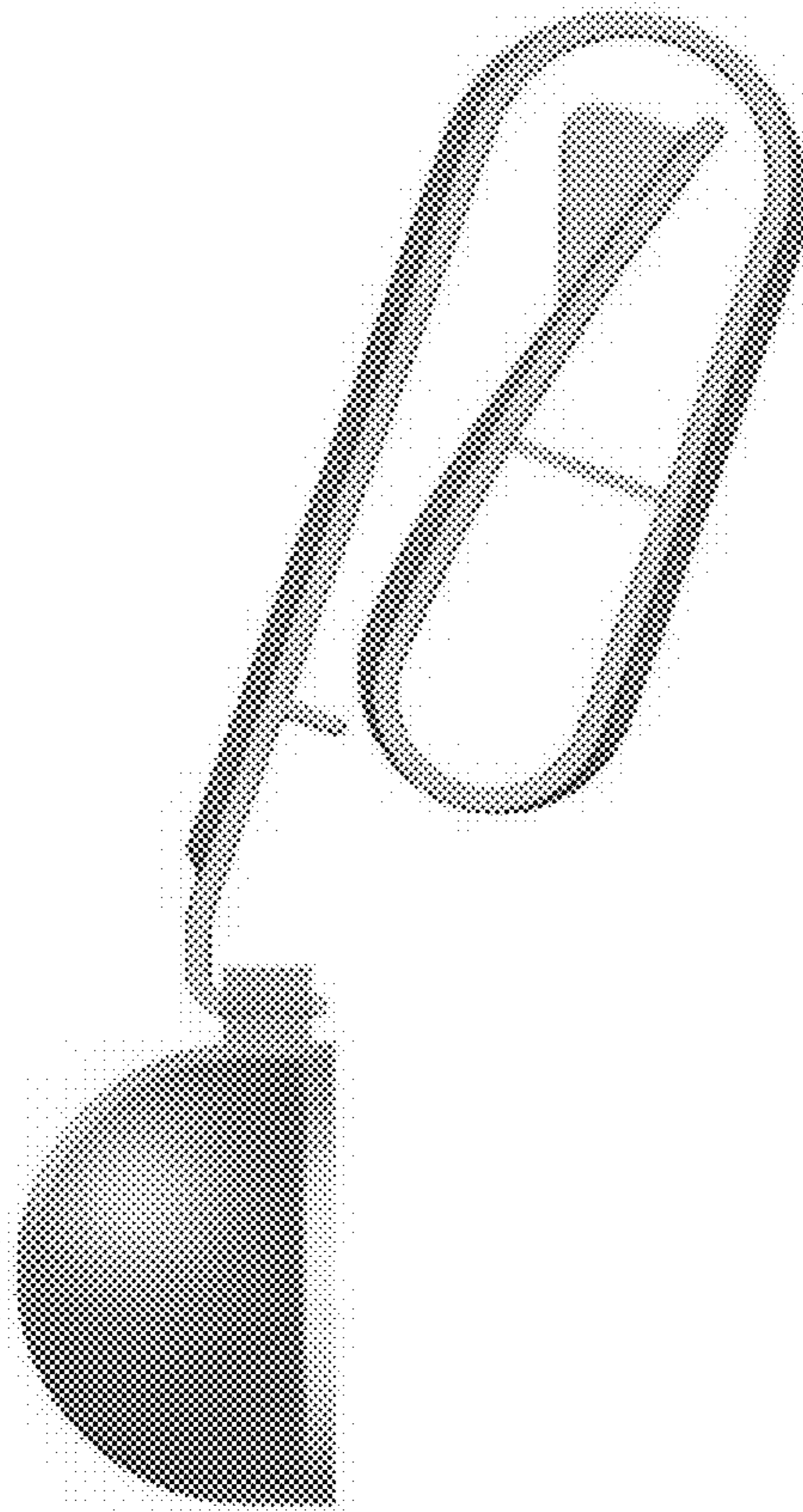

5.4

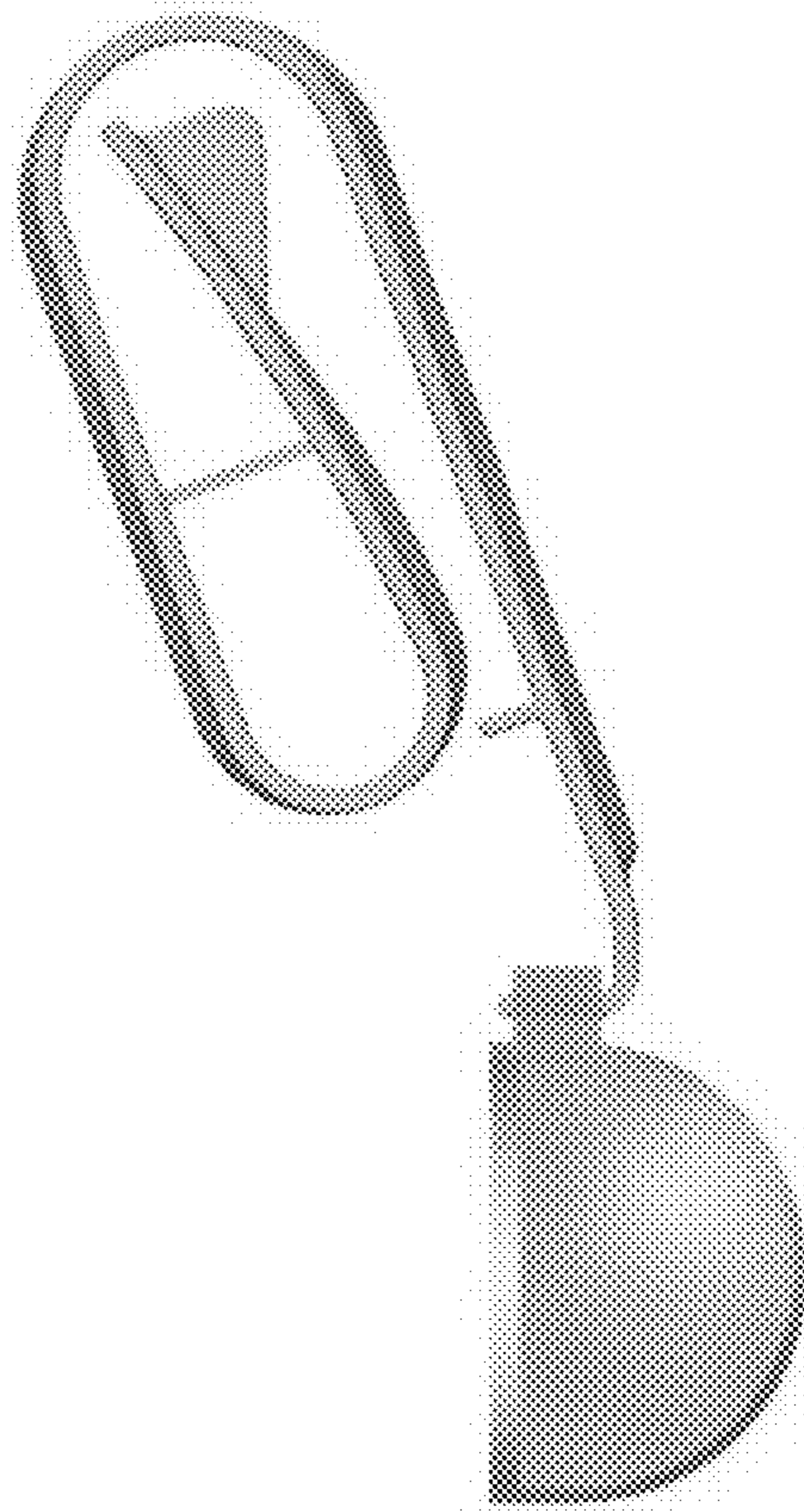

5.5

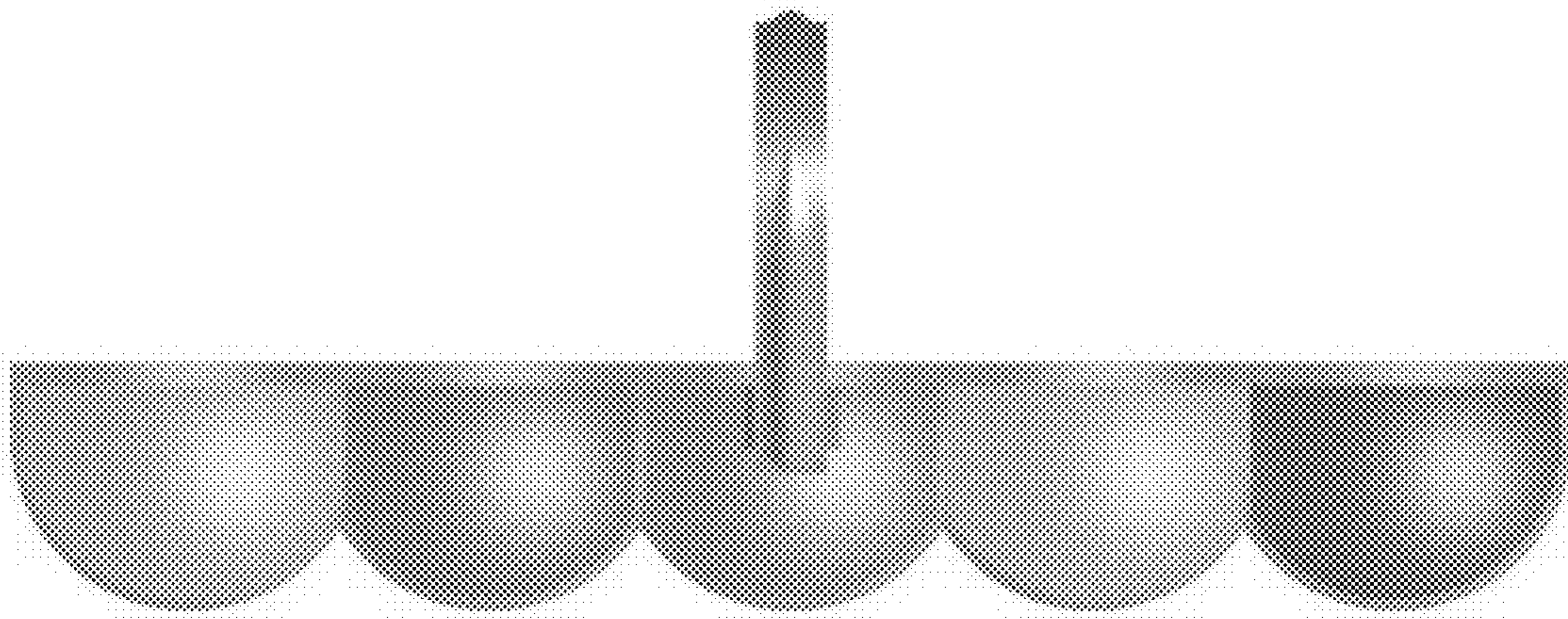



**5.6**

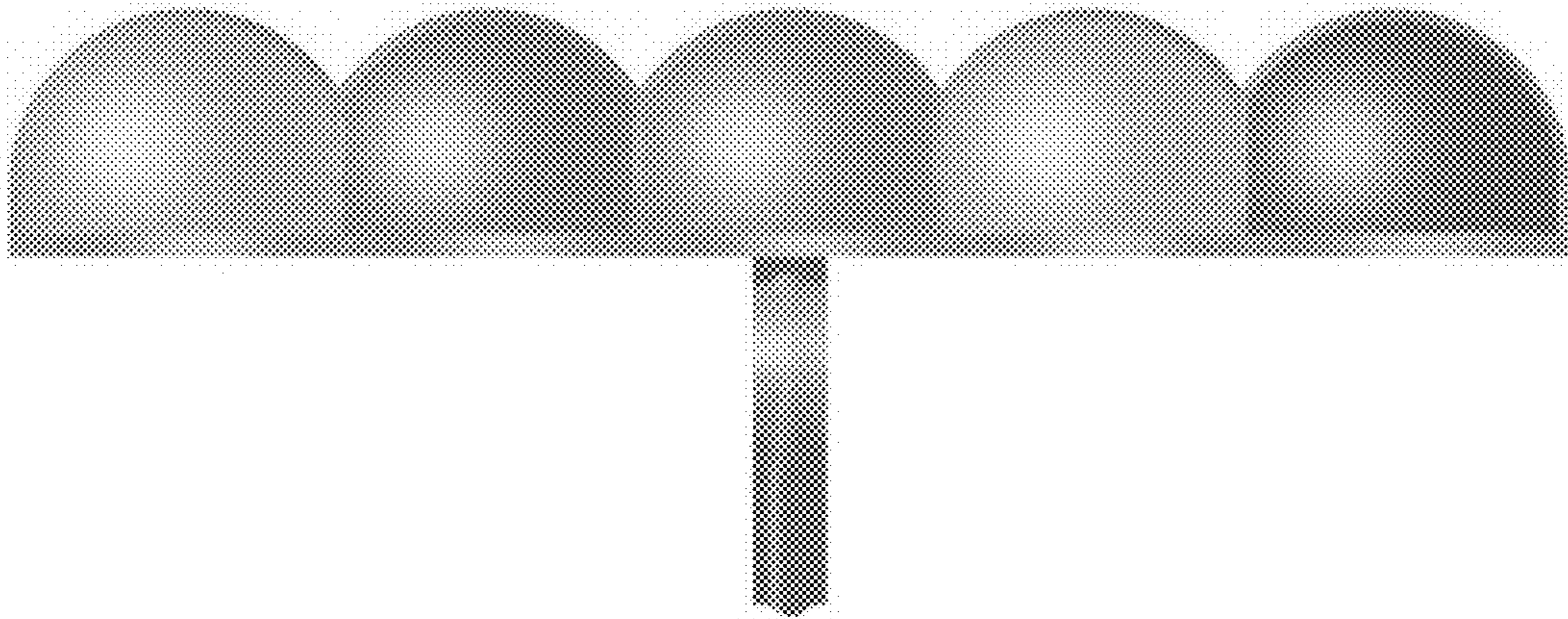

5.7

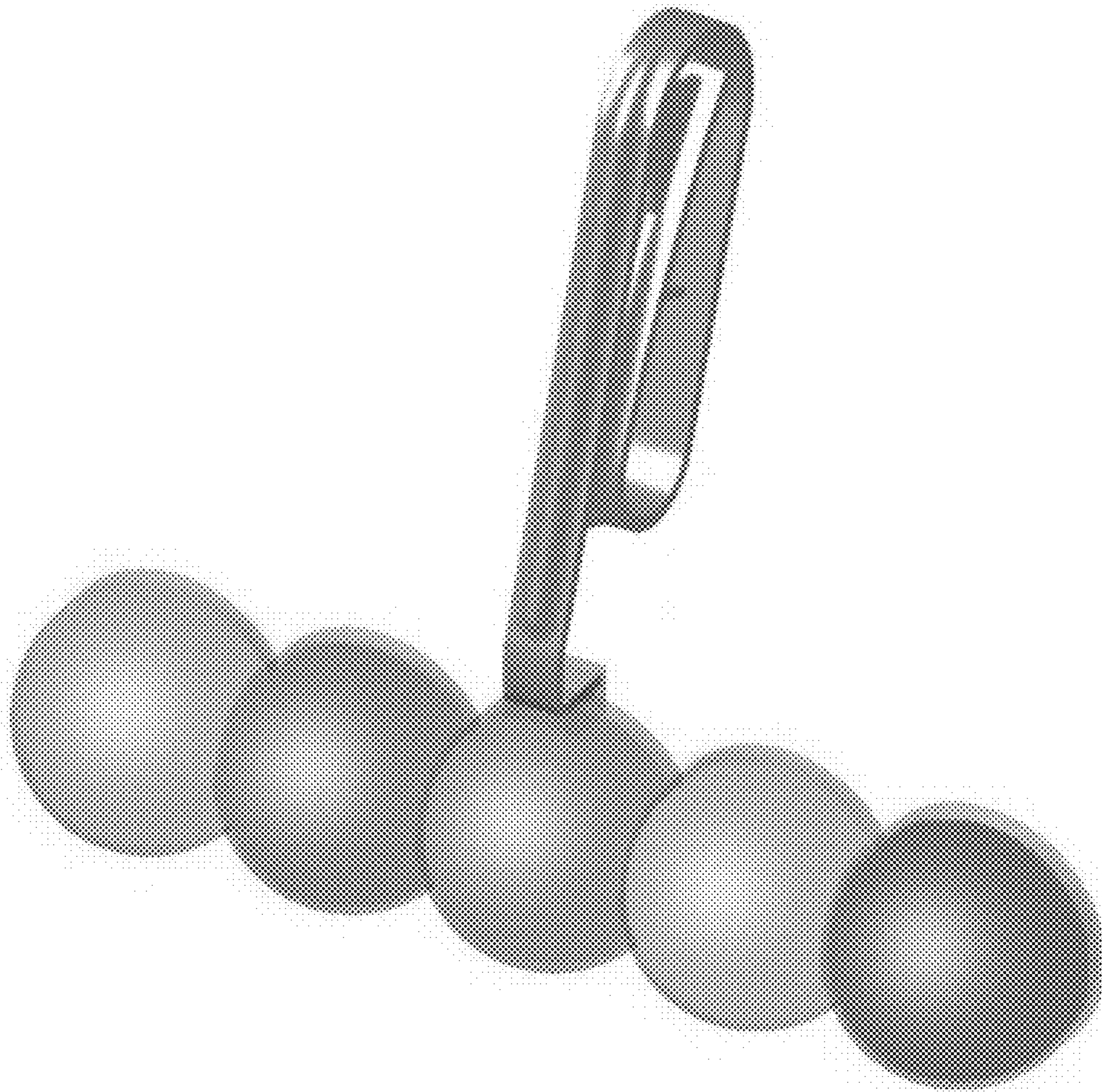

**6.1**

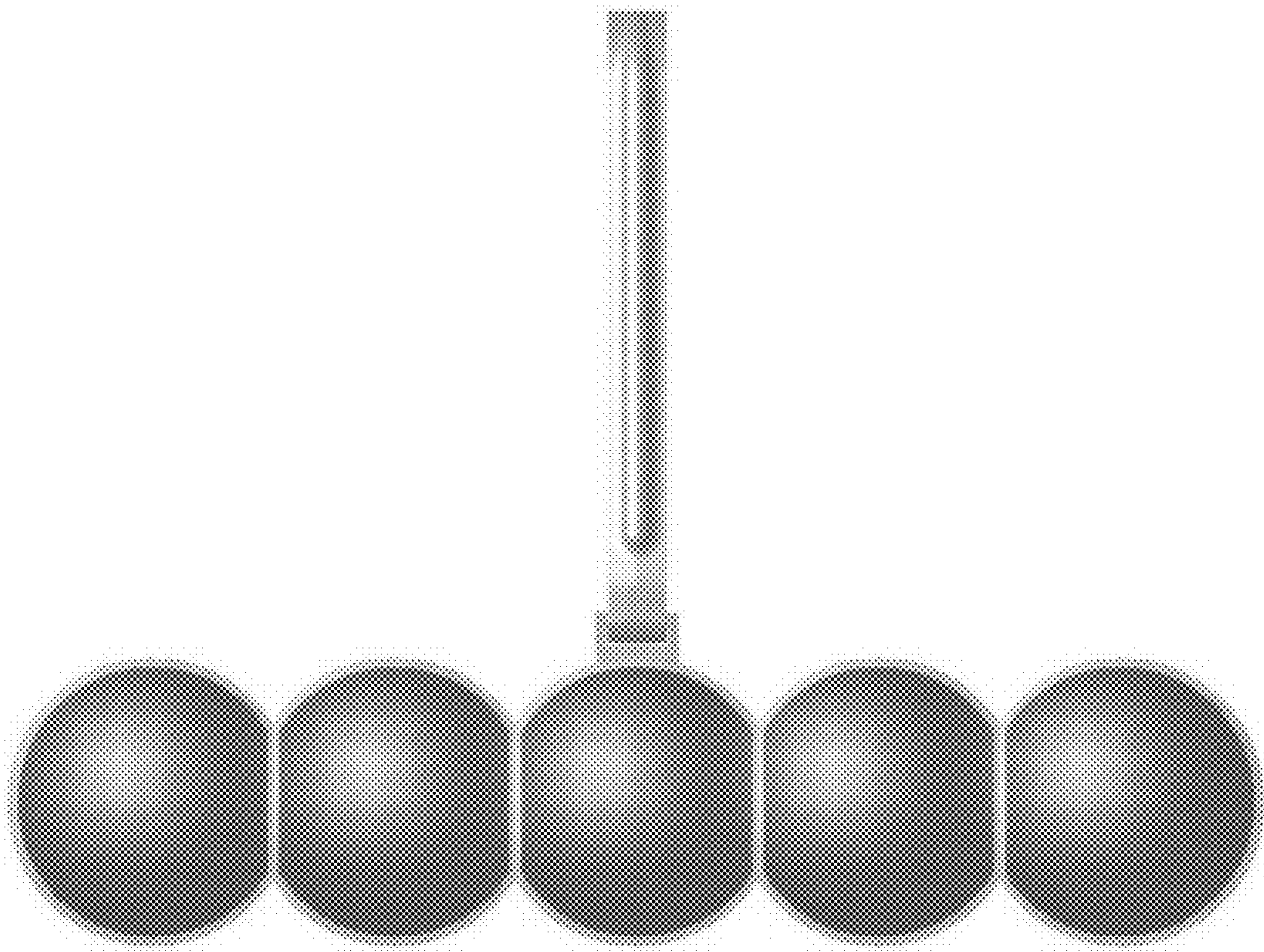



**6.2**

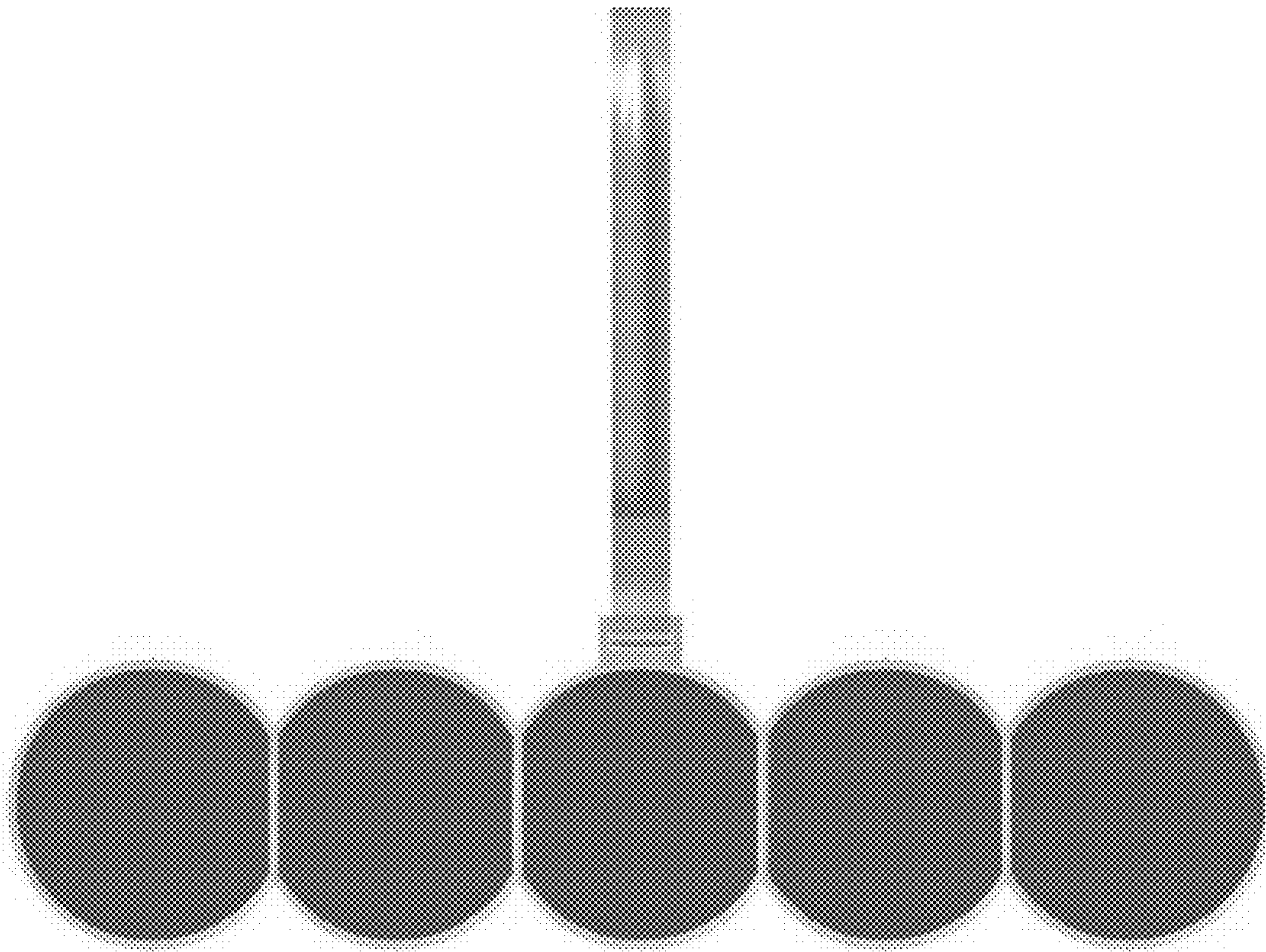

**6.3**

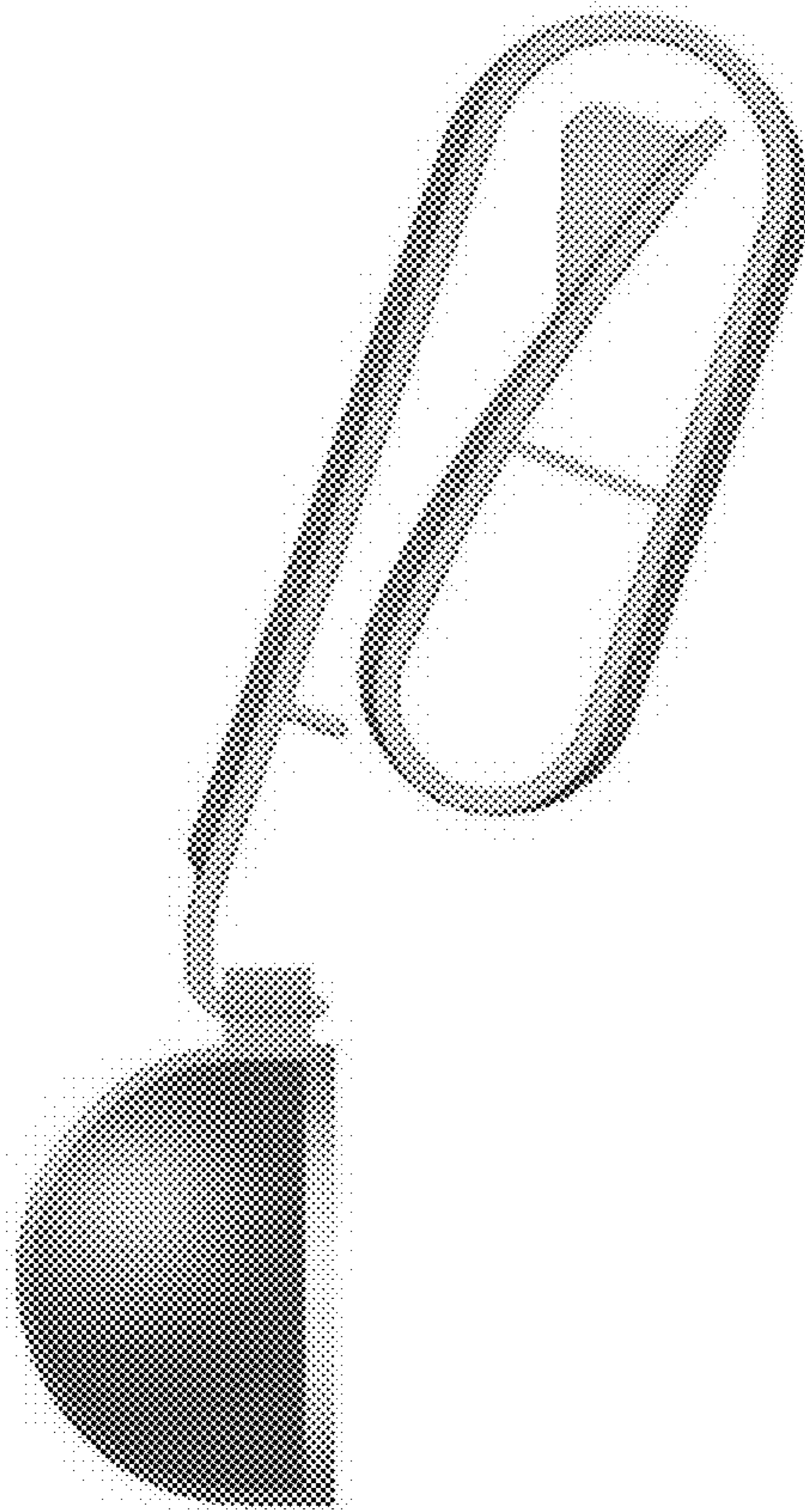

**6.4**

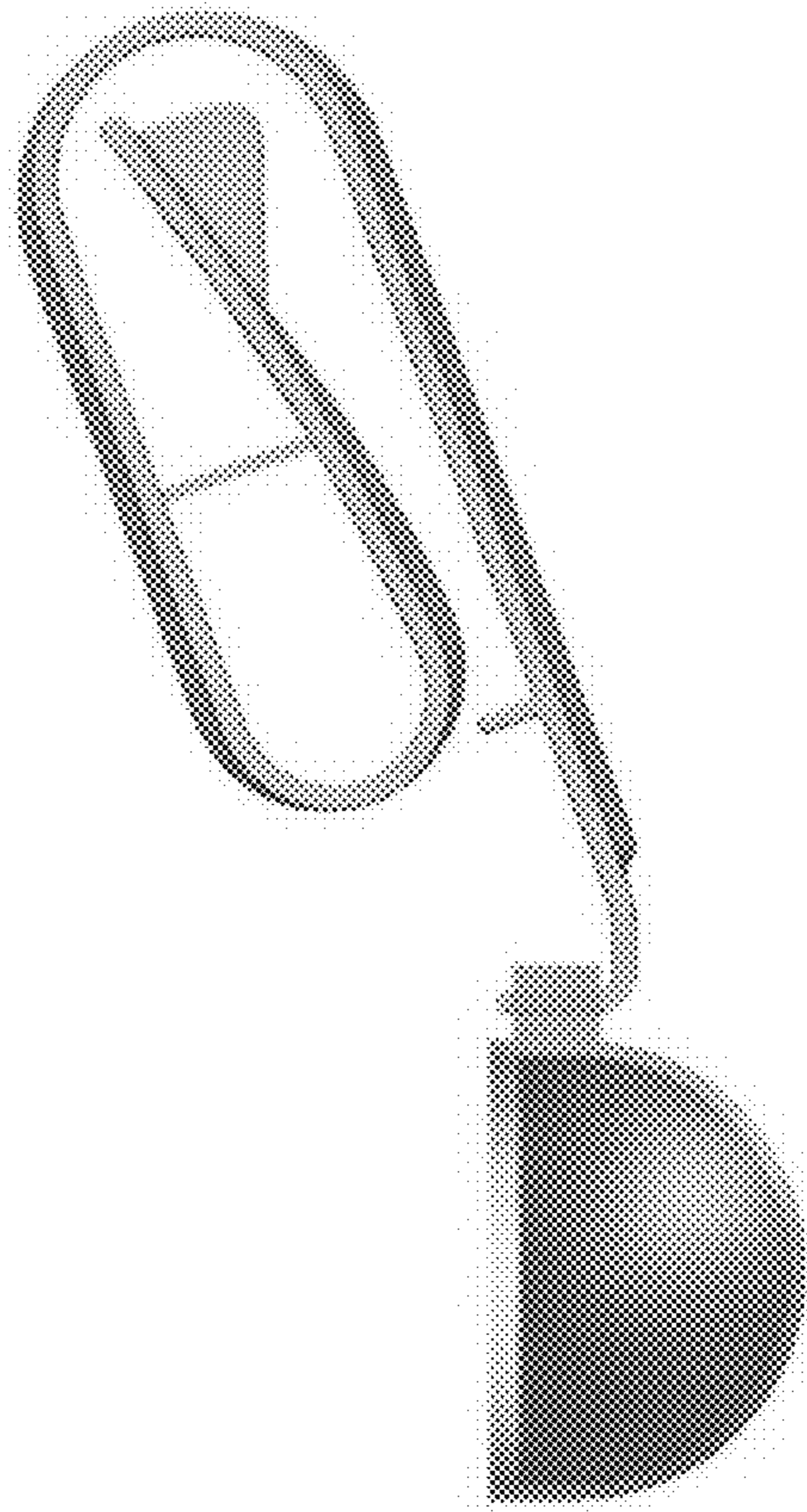



6.5

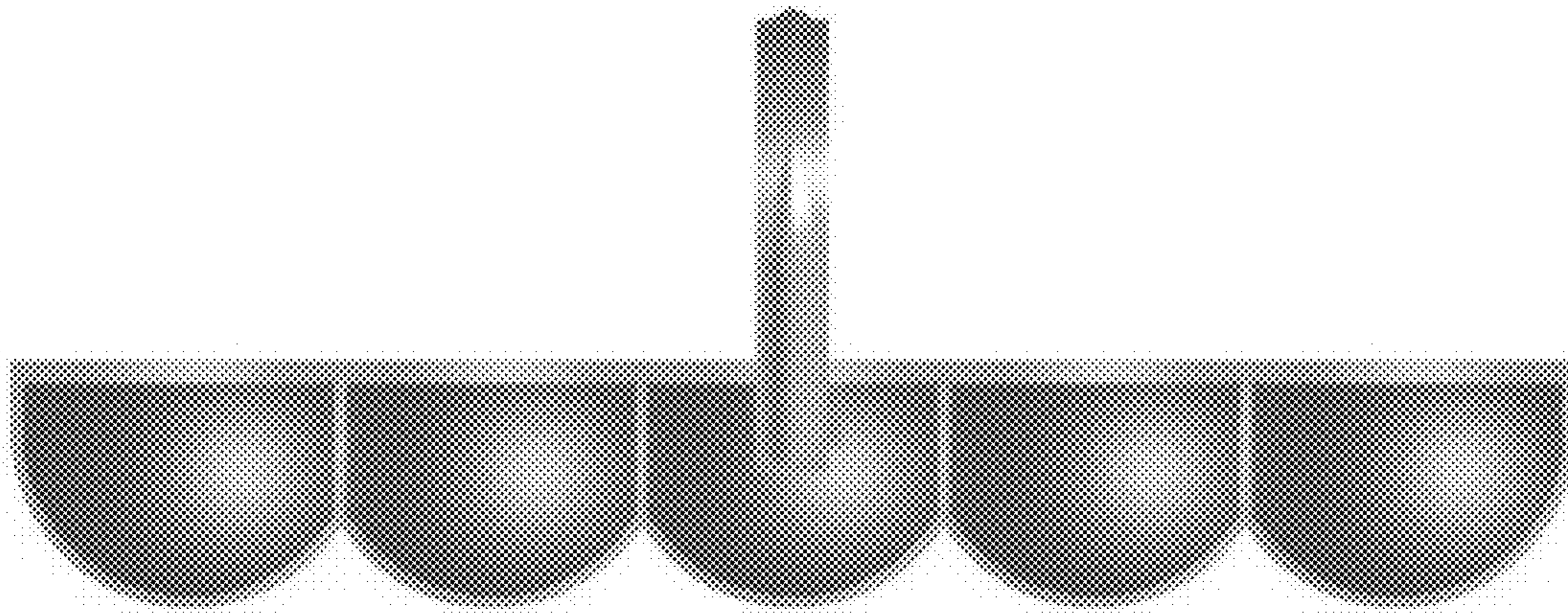

**6.6**

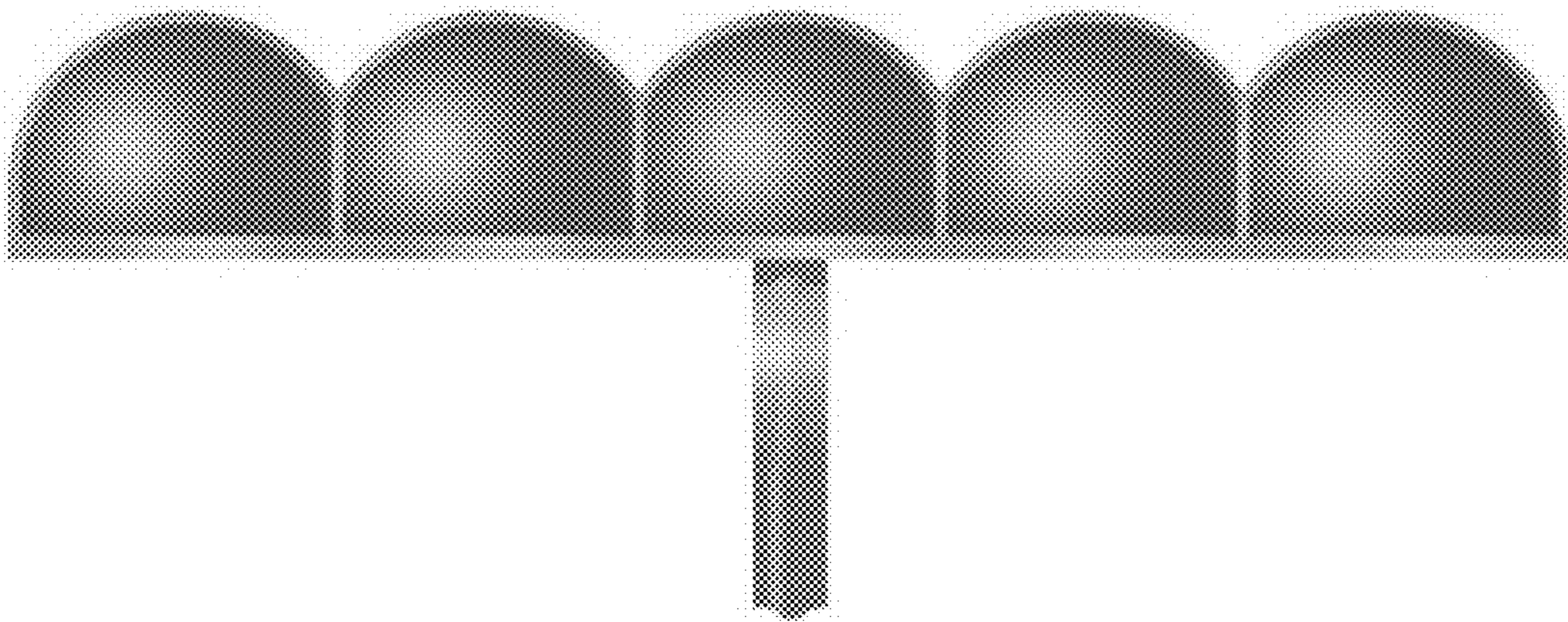

**6.7**

